



Basic Manual

Before Start	2
What's in the box	2
Part Names	3
Part Names	3
Install	7
Installation procedure	7
Step1: Speaker Layout	8
Step2: Connect the Speakers	14
Step3: Connect the TV & AV Components	16
Initial Setup	22
Initial Setup with Auto Start-up Wizard	22
Playback	24
AV Component Playback	24
BLUETOOTH® Playback	24
Network Functions	25
USB Storage Device	26
Listening to the AM/FM Radio	27
Multi-zone	29
Listening Mode	30

[The Basic Manual](#) includes information needed when starting up and also instructions for frequently used operations. [The Advanced Manual](#) has more detailed information and advanced settings.

AV RECEIVER
TX-NR575
ONKYO



What's in the box

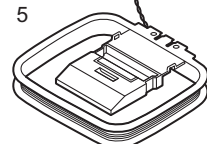
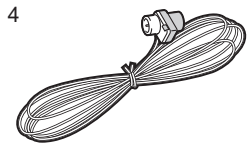
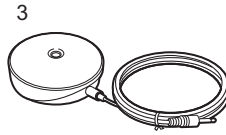
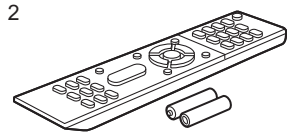
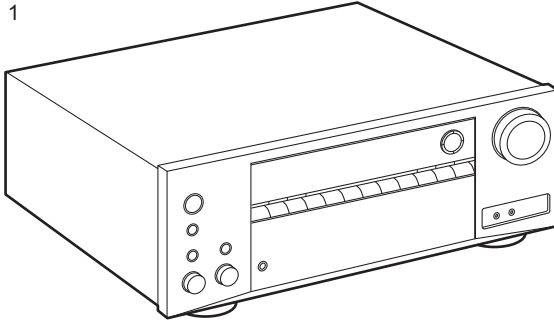

1. Main unit (1)
 2. Remote controller (RC-911R) (1), Batteries (AAA/R03) (2)
 3. Speaker setup microphone (1)
 - Used during Initial Setup.
 4. Indoor FM antenna (1)
 5. AM loop antenna (1)
 - Quick Start Guide (1)
 - Basic Manual (This manual)
- Connect speakers with 4 Ω to 16 Ω impedance.
 - The power cord must be connected only after all other cable connections are completed.
 - We will not accept responsibility for damage arising from the connection of equipment manufactured by other companies.
 - Functionality may be introduced by firmware updates and service providers may cease services, meaning that some network services and content may become unavailable in the future. Furthermore, available services may vary depending on your area of residence.
 - Details on the firmware update will be posted on our website and through other means at a later date.
 - Specifications and appearance are subject to change without prior notice.



(*)You can find details in the Advanced Manual.

Part Names

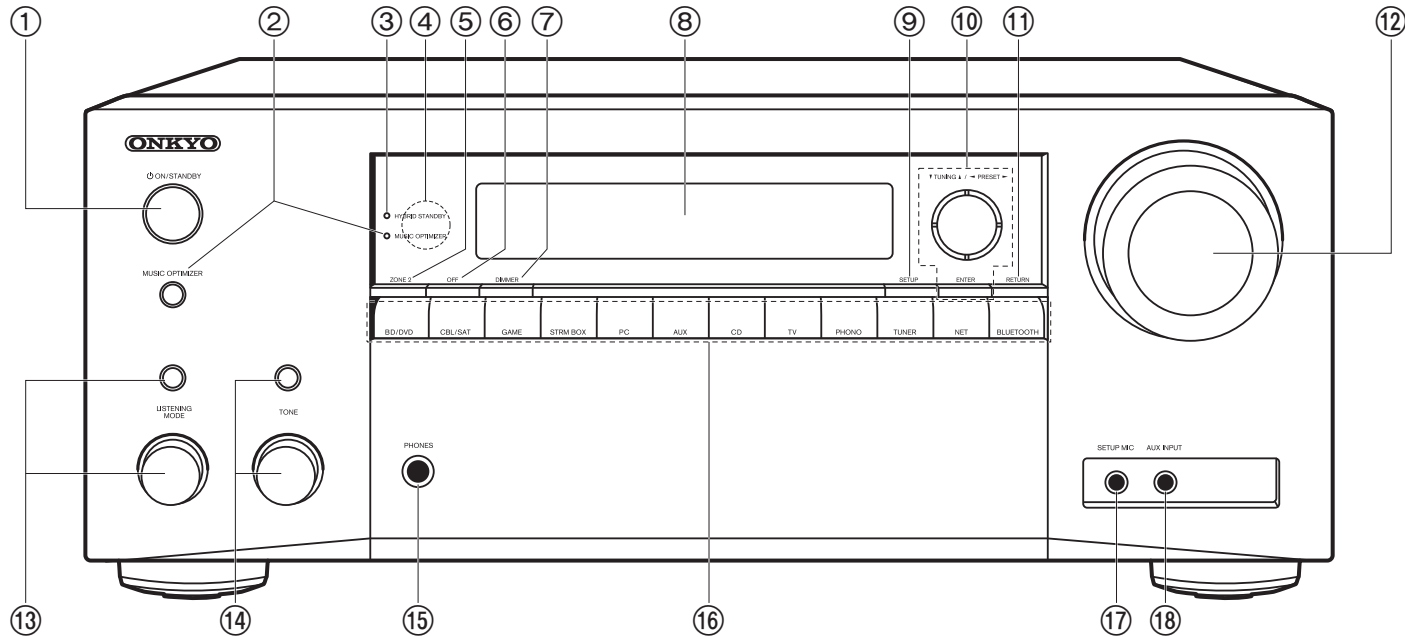

Front Panel

1. ON/STANDBY button
2. MUSIC OPTIMIZER button/indicator: Turns on/off the Music Optimizer function that provides better sound quality for compressed audio.
3. HYBRID STANDBY indicator: Lights if the unit enters standby mode when the features are enabled that continue to work when this unit is in standby, such as HDMI Standby Through and Network Standby.
4. Remote control sensor: Receives signals from the remote controller.
 - The signal range of the remote controller is within about 16'5 m, at an angle of 20° on the perpendicular axis and 30° to either side.
5. ZONE 2 button: Controls the multi-zone function (P29).
6. OFF button: Switches the multi-zone function off (P29).
7. DIMMER button: You can adjust the brightness of the display in three steps. It cannot be turned off completely.
8. Display (P4)
9. SETUP button: You can show advanced setting items on the TV and display to provide you with an even better experience. (*)
10. Cursor buttons (▲ / ▼ / ◀ / ▶) and ENTER button: Select the item with the cursors and press ENTER to confirm. Use them to tune to stations when using TUNER (P27).
11. RETURN button: Returns the display to the previous state.
12. MASTER VOLUME
13. Press the LISTENING MODE button (above) repeatedly to select a category from "Movie/TV", "Music", "Game", then turn the LISTENING MODE dial (below) to change the mode (P30). (*)



(*)You can find details in the Advanced Manual.

- 14. You can adjust the sound quality of the front speakers.
Press the TONE button (above) repeatedly to select the item to adjust from "Bass" and "Treble", and turn the TONE dial (below) to adjust.
- 15. PHONES jack: Headphones with a standard plug (Ø1/4"/6.3 mm) are connected.
- 16. Input selector buttons: Switches the input to be played.
- 17. SETUP MIC jack: The supplied speaker setup microphone is connected.
- 18. AUX INPUT jack: Connect a video camera, etc., using a stereo mini plug cable (Ø1/8"/3.5 mm).

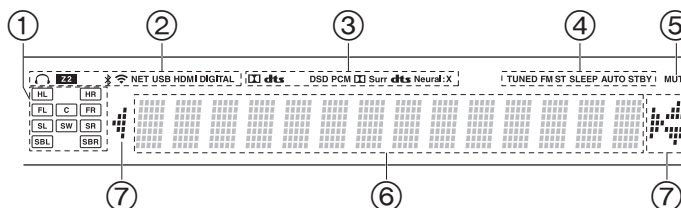

Display

1. Speaker/Channel display: Displays the output channel that corresponds to the selected listening mode.
2. Lights in the following conditions.
 - 🎧: When headphones are connected.
 - Z2: When ZONE 2 is on.
 - 📶: When connected by BLUETOOTH.
 - 📶: When connected by Wi-Fi.
 - NET: When "NET" is selected with the input selector and the unit is connected to the network. It will flash if the connection to the network is not correct.
 - USB: When "NET" is selected with the input selector and the unit is connected by USB and the USB device is selected. Flashes if the USB is not properly connected.
 - HDMI: When HDMI signals are input and the HDMI input is selected.
 - DIGITAL: When digital signals are input and the digital input is selected.
3. Lights according to the type of input digital audio signals and the listening mode.
4. Lights in the following conditions.
 - TUNED: Receiving AM/FM radio.
 - FM ST: Receiving FM stereo.
 - SLEEP: When the sleep timer is set.
 - AUTO STBY: Auto Standby is on.
5. Flashes when muting is on.
6. Displays various information of the input signals.
7. This may light when performing operations with the "NET" input selector.



(*)You can find details in the Advanced Manual.

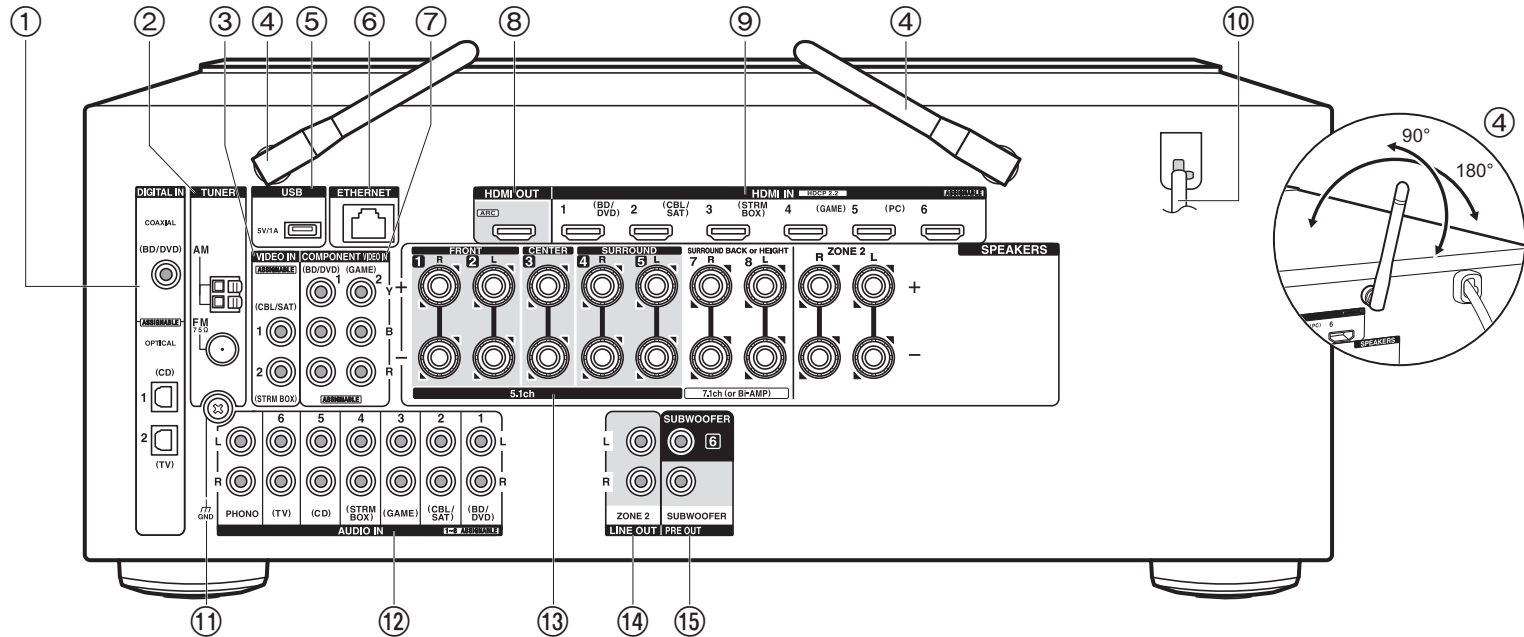

Rear Panel

- 1. DIGITAL IN OPTICAL/COAXIAL jacks: Input TV or AV component digital audio signals with a digital optical cable or digital coaxial cable.
- 2. TUNER AM/FM 75Ω terminal: The supplied antennas are connected.
- 3. VIDEO IN jacks: Input the AV component video signals with an analog video cable.
- 4. Wireless antenna: Used for Wi-Fi connection or when using a BLUETOOTH wireless technology enabled device. Adjust their angles according to the connection status.
- 5. USB port: A USB storage device is connected so that music files stored in it can be played. You can also supply power (5 V/1 A) to USB devices with a USB cable.
- 6. ETHERNET port: Connect to the network with an Ethernet cable.
- 7. COMPONENT VIDEO IN jacks: Input the AV component video signals with a component video cable. (Compatible only with 480i or 576i resolution.)
- 8. HDMI OUT jacks: Transmit video signals and audio signals with a HDMI cable connected

- to a TV.
- 9. HDMI IN jacks: Transmit video signals and audio signals with a HDMI cable connected to an AV component.
- 10. Power cord
- 11. GND terminal: The ground wire of the turntable is connected.
- 12. AUDIO IN jacks: Input TV or AV component audio signals with an analog audio cable.
- 13. SPEAKERS terminals: Connect speakers with speaker cables. (Compatible with banana plugs) You can connect the multichannel speakers for the main room and the speakers for a separate room (ZONE 2).
- 14. ZONE 2 LINE OUT jack: Output audio signals with an analog audio cable to a pre-main amplifier in a separate room (ZONE 2).



(*)You can find details in the Advanced Manual.

15. SUBWOOFER PRE OUT jack: Connect a powered subwoofer with a subwoofer cable. Up to two powered subwoofers can be connected. The same signal is output from each of the SUBWOOFER PRE OUT jacks.

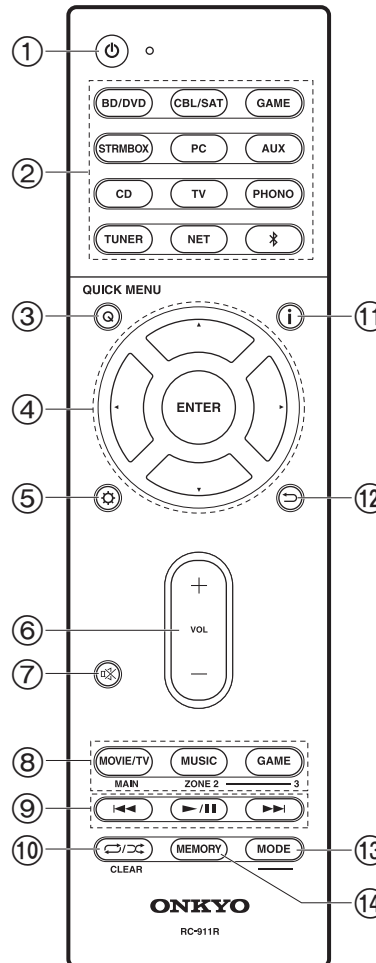

Remote Controller

1. ON/STANDBY button
2. Input selector buttons: Switches the input to be played.
3. Q (QUICK MENU) button: Settings such as "Tone" and "Level" can be made quickly during play on the TV screen. (*)
4. Cursor buttons and ENTER button: Select the item with the cursors and press ENTER to confirm your selection. When the folder or file lists are not shown on one screen on the TV, press ◀ / ▶ to change the screen.
5. ⚙ button: You can show advanced setting items on the TV and display to provide you with an even better experience. (*)
6. Volume buttons
7. 🔇 button: Temporarily mutes audio. Press again to cancel muting.
8. LISTENING MODE buttons: Allows you to select the listening mode (P30). (*) MAIN/ZONE 2 buttons: Controls the multi-zone function (P29). (The ZONE 3 button is not used with this unit.)
9. Play buttons: Used for play operations when playing Music Server or USB.
10. ↺/↻ button: You can start repeat/random play of the Music Server or USB. Each time you press the button, the mode switches from 1 (1-track repeat), to (folder repeat), to (random). CLEAR button: Deletes all characters you have entered when entering text on the TV screen.
11. i button: Switches the information on the display.
12. ⏪ button: Returns the display to the previous state.
13. MODE button: Switches tuning to an AM/FM radio station between automatic tuning and manual tuning.
14. MEMORY button: Used to register AM/FM radio stations.

Tips

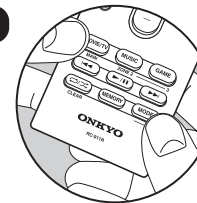

When the remote controller isn't working: The remote controller may have switched to the mode for controlling ZONE 2. While holding down MODE, press MAIN for 3 seconds or more until the remote indicator flashes once to switch it to the mode to control the main room.



Installation procedure

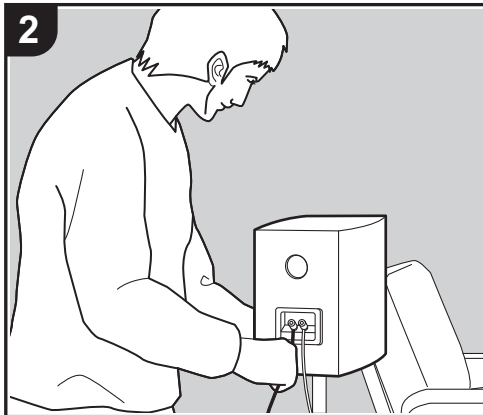

This unit can be used in a number of ways, depending on the layout of the speakers you are installing, and the connections made to external devices. Read the following to help make the installation process smoother.

Step1: Speaker Layout

Select the speaker layout that suits the types of speakers you have and the conditions they will be used in from the choices presented on pages P8 to P12, then install the speakers by referring to the illustrations and explanations on the relevant page. Speaker layouts include systems that use surround back speakers, systems that use height speakers, and systems that use Bi-Amping speakers. Also refer to the combinations available in "Speaker combinations" on P13.

Step2: Connect the Speakers

To connect the speaker systems to this unit, refer to P14 if you are using a speaker layout described on one of P8 to P11, and to P15 to use a speaker layout using Bi-Amping speakers described on P12. The connection process will be smoother if you refer to the illustrations and explanations and prepare the required cables before hand.

Step3: Connect the TV & AV Components

Refer to P16 to P21 to connect your external devices such as your TV, Blu-ray Disc Player, and also supplied accessories such as the antennas. Also, P20 introduces the Multi-zone Connection option that allows you to play audio into rooms other than the main room. The connection process will be smoother if you refer to the illustrations and explanations, confirm the connection types on the external devices, and prepare the required cables before hand.



Step1: Speaker Layout

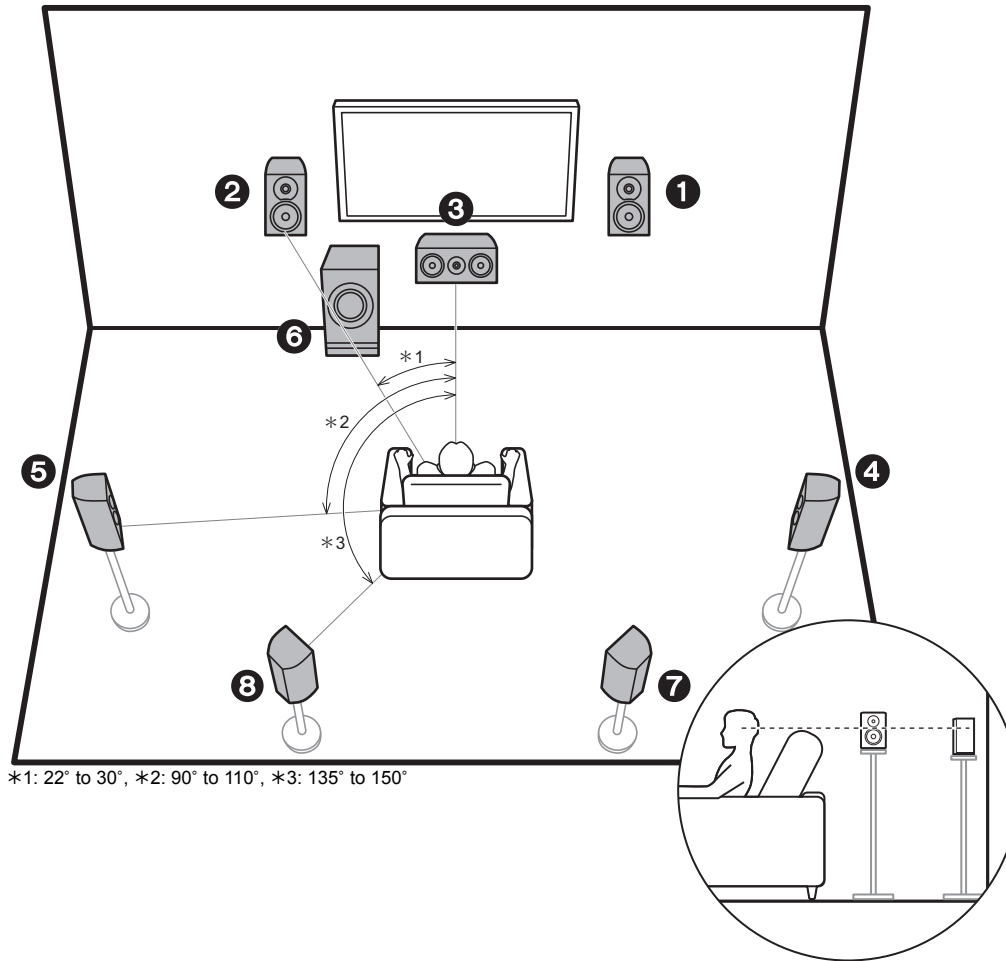

*1: 22° to 30°, *2: 90° to 110°, *3: 135° to 150°

7.1 Channel System

Front speakers output front stereo sound and a center speaker outputs center sound such as dialogs and vocals. Surround speakers create back sound field. Powered subwoofer reproduces bass sounds and creates rich sound field.

This basic 5.1 Channel System with surround back speakers added is called a 7.1 Channel System. The connection of surround back speakers improves the sense of envelopment and connectivity of sound created by the back sound field and provides a more real sound field.

Furthermore, by installing surround back speakers, you can select the Dolby Atmos listening mode, which realizes the most up-to-date 3D sound, when the input format is Dolby Atmos.

The front speakers should be positioned at ear height, while the surround speakers should be positioned just above ear height. Center speaker should be set up facing the listening position. Placing the powered subwoofer between the center speaker and a front speaker gives you a natural sound even when playing music. The optimal positioning is for surround back speakers to be at ear height.

- If you are including surround back speakers in the setup, surround speakers are required.
- "Speaker combinations" (P13) introduces some detailed examples of speaker combinations.

- 1,2 Front Speakers
- 3 Center Speaker
- 4,5 Surround Speakers
- 6 Powered Subwoofer
- 7,8 Surround Back Speakers

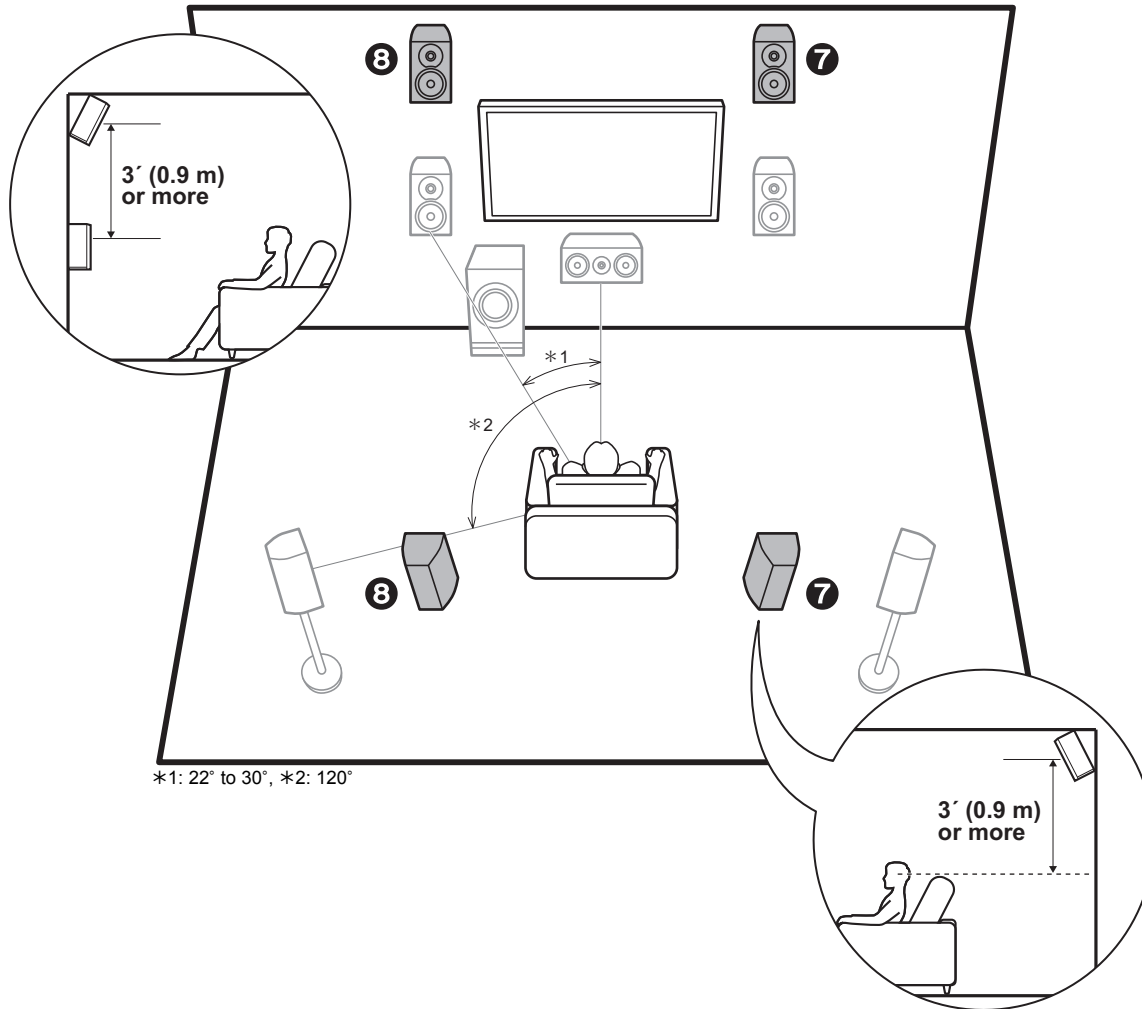

5.1.2 Channel System-1 (Front High Speakers/Rear High Speakers)

This is a basic 5.1 channel system consisting of front speakers, a center speaker, surround speakers, and a powered subwoofer, with the addition of front height speakers or rear high speakers, which are both types of height speakers. By installing height speakers, you can select the Dolby Atmos listening mode, which realizes the most up-to-date 3D sound including overhead sounds, when the input format is Dolby Atmos. Front high speakers or rear high speakers should be situated at least 3' / 0.9 m higher than the front speakers. Front high speakers should be situated directly above the front speakers and the distance between the rear high speakers should match the distance between the front speakers. Both should be set up facing the listening position.

- "Speaker combinations" (P13) introduces some detailed examples of speaker combinations.

7,8 Height Speakers

Choose one of the following:

- Front High Speakers
- Rear High Speakers

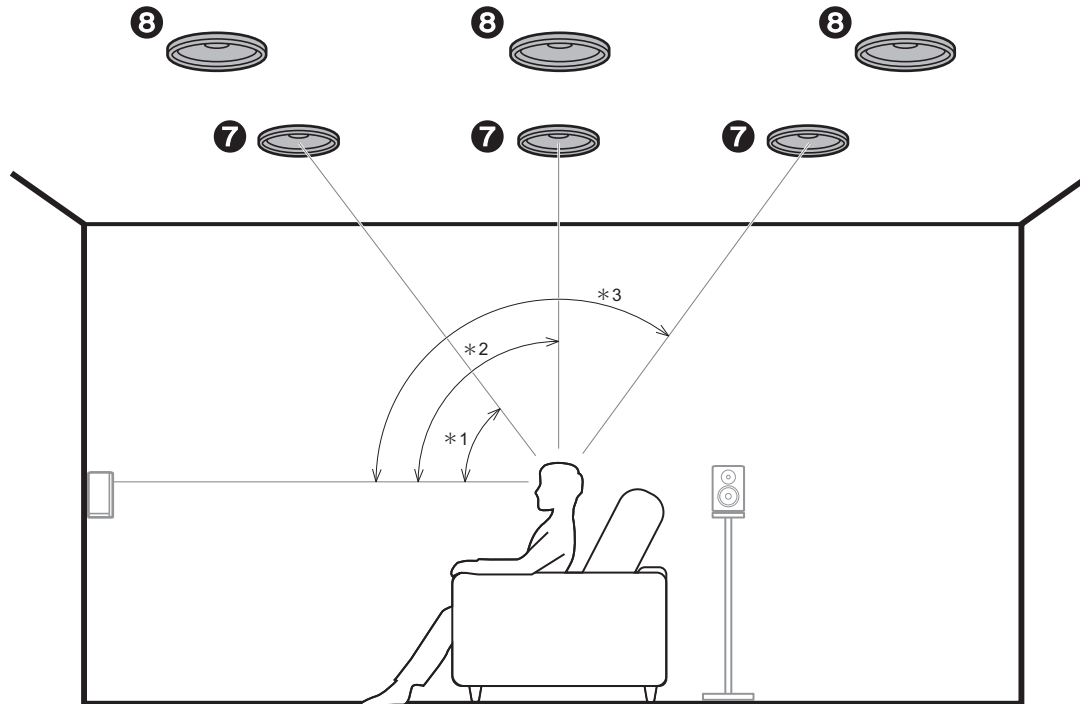

*1: 30° to 55°, *2: 65° to 100°, *3: 125° to 150°

5.1.2 Channel System-2 (Ceiling Speakers)

This is a basic 5.1 channel system consisting of front speakers, a center speaker, surround speakers, and a powered subwoofer, with the addition of top front speakers, top middle speakers, or top rear speakers, which are types of height speakers. By installing height speakers, you can select the Dolby Atmos listening mode, which realizes the most up-to-date 3D sound including overhead sounds, when the input format is Dolby Atmos. Fit top front speakers on the ceiling forward of the seating position, top middle speakers on the ceiling directly above the seating position, and top rear speakers on the ceiling behind the seating position. The distance between each pair should match the distance between the two front speakers.

- Dolby Laboratories recommends placing this type of height speakers to obtain the best Dolby Atmos effect.
- "Speaker combinations" (P13) introduces some detailed examples of speaker combinations.

7,8 Height Speakers

Choose one of the following:

- Top Front Speakers
- Top Middle Speakers
- Top Rear Speakers

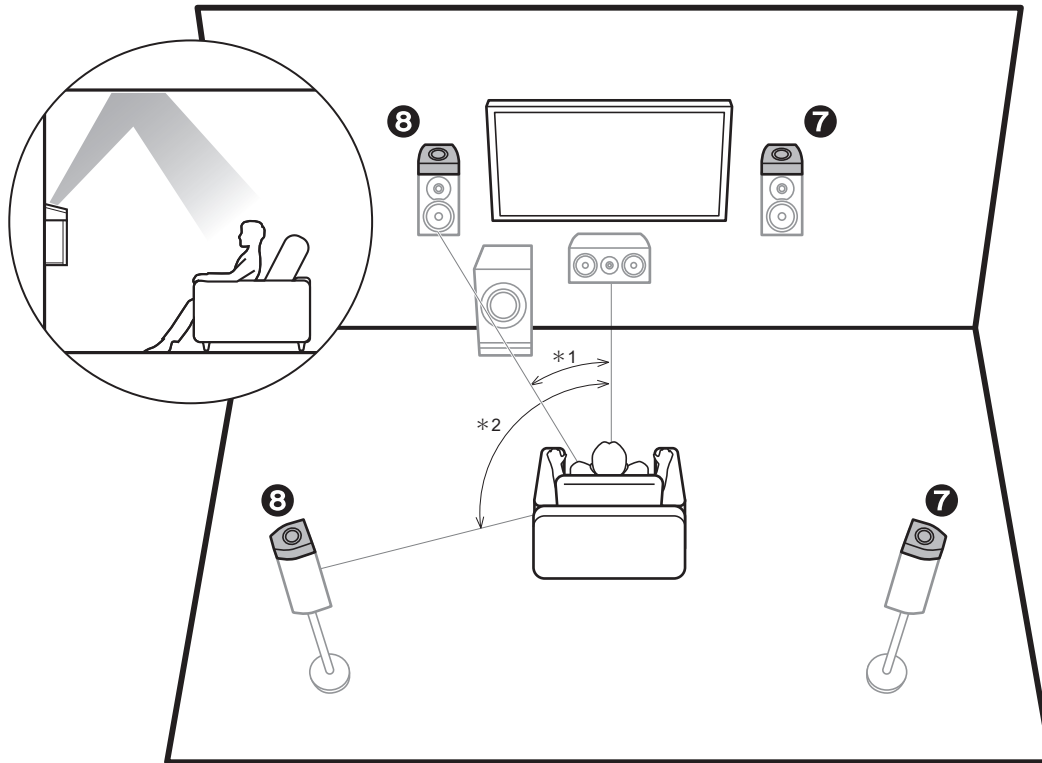

*1: 22° to 30°, *2: 120°

5.1.2 Channel System-3 (Dolby Enabled Speakers (Dolby Speakers))

This is a basic 5.1 channel system consisting of front speakers, a center speaker, surround speakers, and a powered subwoofer, with the addition of Dolby enabled speakers (front) or Dolby enabled speakers (surround), which are both types of height speakers. Dolby enabled speakers are special speakers designed to face the ceiling so that sound is heard after bouncing off the ceiling so that sound appears to be coming from overhead. By installing height speakers, you can select the Dolby Atmos listening mode, which realizes the most up-to-date 3D sound including overhead sounds, when the input format is Dolby Atmos.

Place them either above the front speakers or above the surround speakers.

- "Speaker combinations" (P13) introduces some detailed examples of speaker combinations.

7,8 Height Speakers

Choose one of the following:

- Dolby Enabled Speakers (Front)
- Dolby Enabled Speakers (Surround)

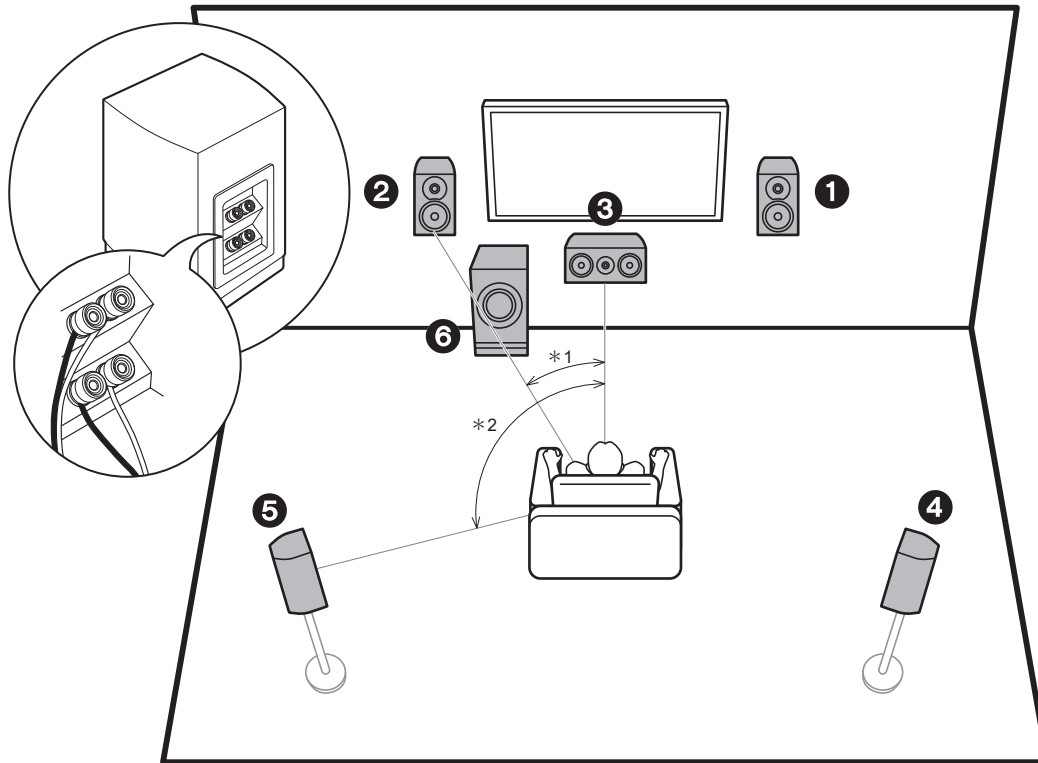

*1: 22° to 30°, *2: 120°

Bi-Amping the Speakers

With a 5.1 channel system, it is possible to connect front speakers that support Bi-Amping to improve the quality of the bass and treble. Bi-Amping compatible speakers need their terminals for the tweeters connected to one amplifier and their terminals for woofers connected to another amplifier, so it is not possible to connect height speakers and surround back speakers with this connection. Other than front speakers, you can also connect a center speaker, surround speakers, and a powered subwoofer.

- "Speaker combinations" (P13) introduces some detailed examples of speaker combinations.

- 1,2 Front Speakers (Bi-Amping)
- 3 Center Speaker
- 4,5 Surround Speakers
- 6 Powered Subwoofer



Speaker combinations

- In any of the combinations, up to two powered subwoofers can be connected.

Speaker Channels	FRONT	CENTER	SURROUND	SURROUND BACK	HEIGHT	Bi-AMP	ZONE 2 (ZONE SPEAKER) (P20)
2.1 ch	✓					✓ (*1)	✓ (*1)
3.1 ch	✓	✓				✓ (*1)	✓ (*1)
4.1 ch	✓		✓			✓ (*1)	✓ (*1)
5.1 ch	✓	✓	✓			✓ (*1)	✓ (*1)
6.1 ch	✓		✓	✓ (*2)			✓
7.1 ch	✓	✓	✓	✓ (*2)			✓
2.1.2 ch	✓				✓ (*3)		✓
3.1.2 ch	✓	✓			✓ (*3)		✓
4.1.2 ch	✓		✓		✓ (*3)		✓
5.1.2 ch	✓	✓	✓		✓ (*3)		✓

(*1) You can select Bi-AMP or ZONE SPEAKER.

(*2) No sound is played from the surround back speakers when playing audio from ZONE SPEAKER.

(*3) No sound is played from the height speakers when playing audio from ZONE SPEAKER.



Step2: Connect the Speakers

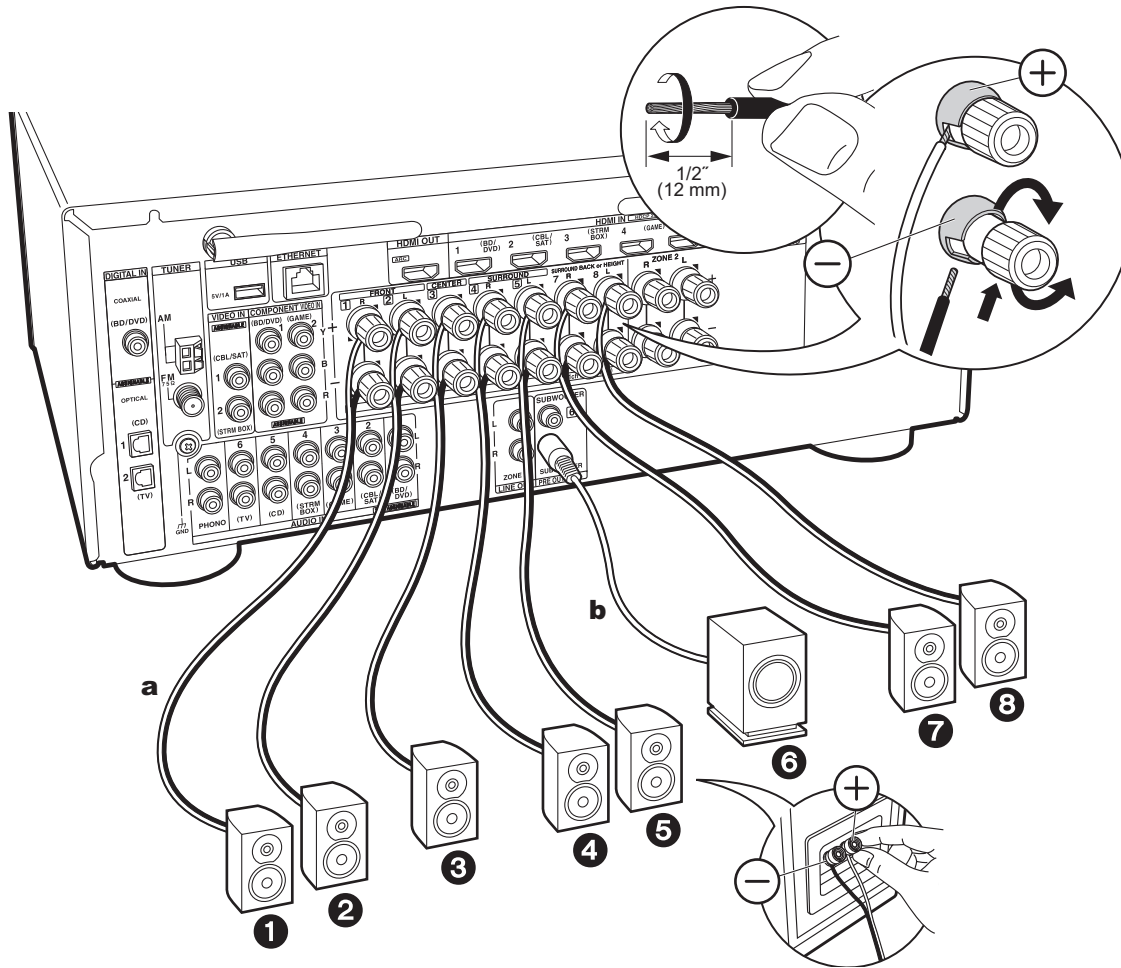

a Speaker cable, **b** Subwoofer cable

Standard Connections (Pages 8 to 11)

Up to two powered subwoofers can be connected. The same signal is output from each of the SUBWOOFER PRE OUT jacks.



Setup

- Settings for the speaker configuration you have connected need to be made in "1. AccuEQ Room Calibration" in Initial Setup (P22).
- If any of the connected speakers have an impedance of 4 Ω or more to less than 6 Ω, after completing Initial Setup, you need to make some settings in the Setup menu. Press ⚙ on the remote controller, select "2. Speaker" - "Configuration" and set "Speaker Impedance" to "4ohms".

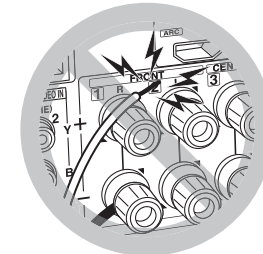

Make sure the exposed wires of the speakers do not stick out of the speaker terminals when connecting. If the exposed wires of the speakers touch the rear panel or the + and - wires touch each other, the protection circuit will be activated.

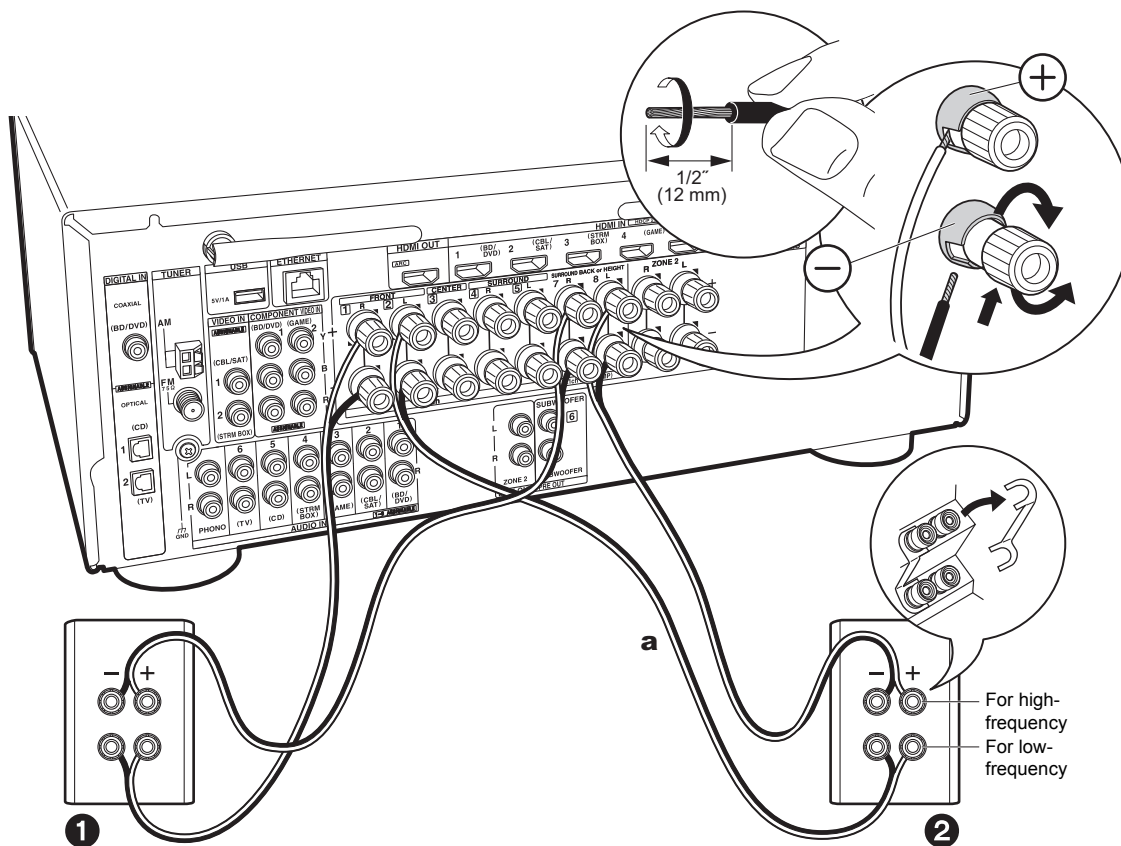

a Speaker cable

Connecting with Bi-Amping Speakers (Page 12)

Make sure you remove the jumper bar fitted between the woofer jacks and tweeter jacks of the front speakers. Refer to "Standard Connections (Pages 8 to 11)" (P14) to connect the center speaker, surround speakers, and powered subwoofer.

- Also refer to the instruction manual for your speakers when using connections for Bi-Amping.



Setup

- Settings for the speaker configuration you have connected need to be made in "1. AccuEQ Room Calibration" in Initial Setup (P22).
- If any of the connected speakers have an impedance of 4 Ω or more to less than 6 Ω, after completing Initial Setup, you need to make some settings in the Setup menu. Press ⚙ on the remote controller, select "2. Speaker" - "Configuration" and set "Speaker Impedance" to "4ohms".

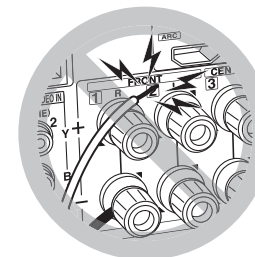

Make sure the exposed wires of the speakers do not stick out of the speaker terminals when connecting. If the exposed wires of the speakers touch the rear panel or the + and - wires touch each other, the protection circuit will be activated.



Step3: Connect the TV & AV Components

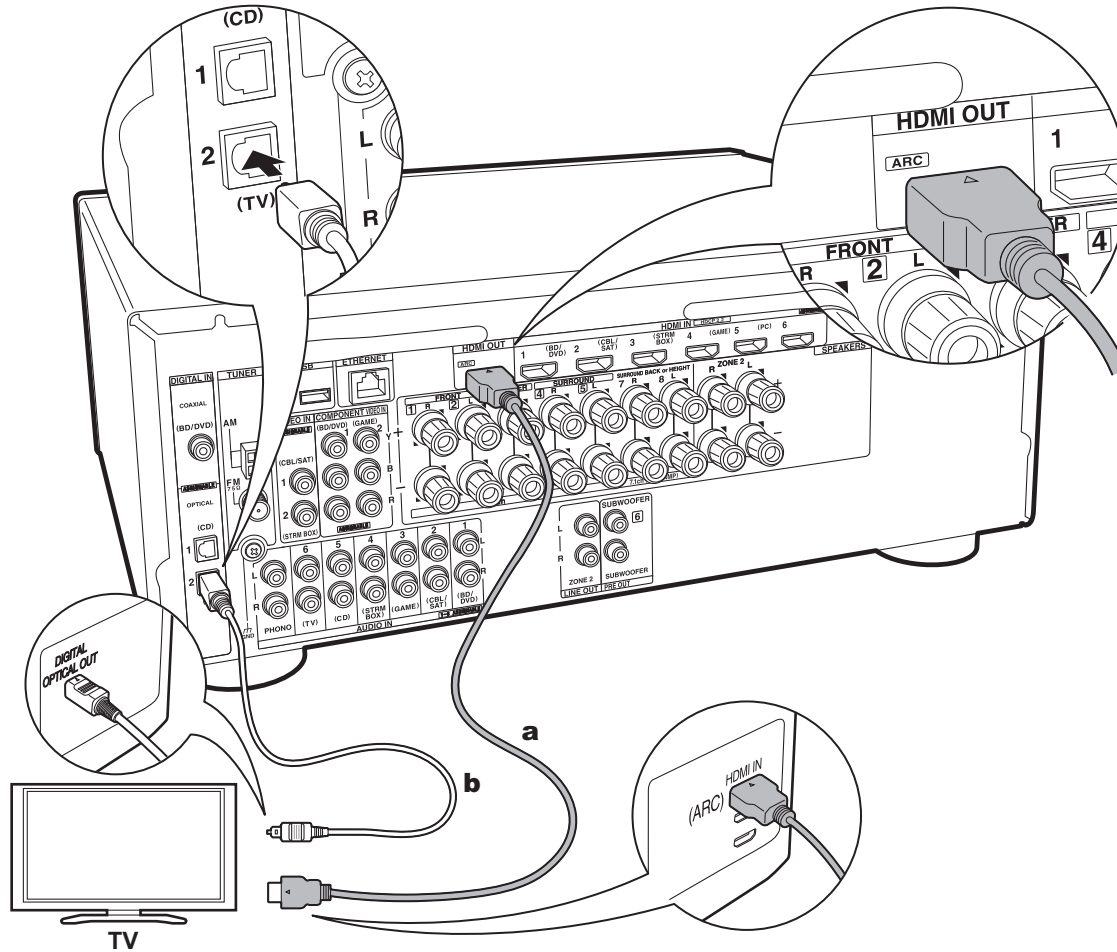

a HDMI cable, **b** Digital optical cable

1. Connect the TV

To ARC TV

For a TV that supports the ARC (Audio Return Channel) (*) feature, use an HDMI cable and connect according to illustration "a". Choose an HDMI IN jack on the TV that supports ARC when connecting.



Setup

- Settings are required to use the ARC function. Select "Yes" in "5. Audio Return Channel" (P23) in the Initial Setup.
- Refer to the instruction manual for the TV for TV connections and instructions regarding settings for CEC features and audio output.

To Non-ARC TV

For a TV that does not support the ARC (Audio Return Channel) feature (*), connect both the HDMI cable in illustration "a" and the digital optical cable in "b".

- Connection with a digital optical cable is not necessary if you will watch TV through a device such as a cable set-top box (that is, not use a tuner built into the TV) that you have connected to the input jack on this unit.

(*)The ARC feature: This feature transfers TV audio signals via HDMI cable so that you can play the audio from the TV through this unit. Connection to an ARC compatible TV is complete with one HDMI cable. Refer to the instruction manual for your TV to see if it supports ARC.

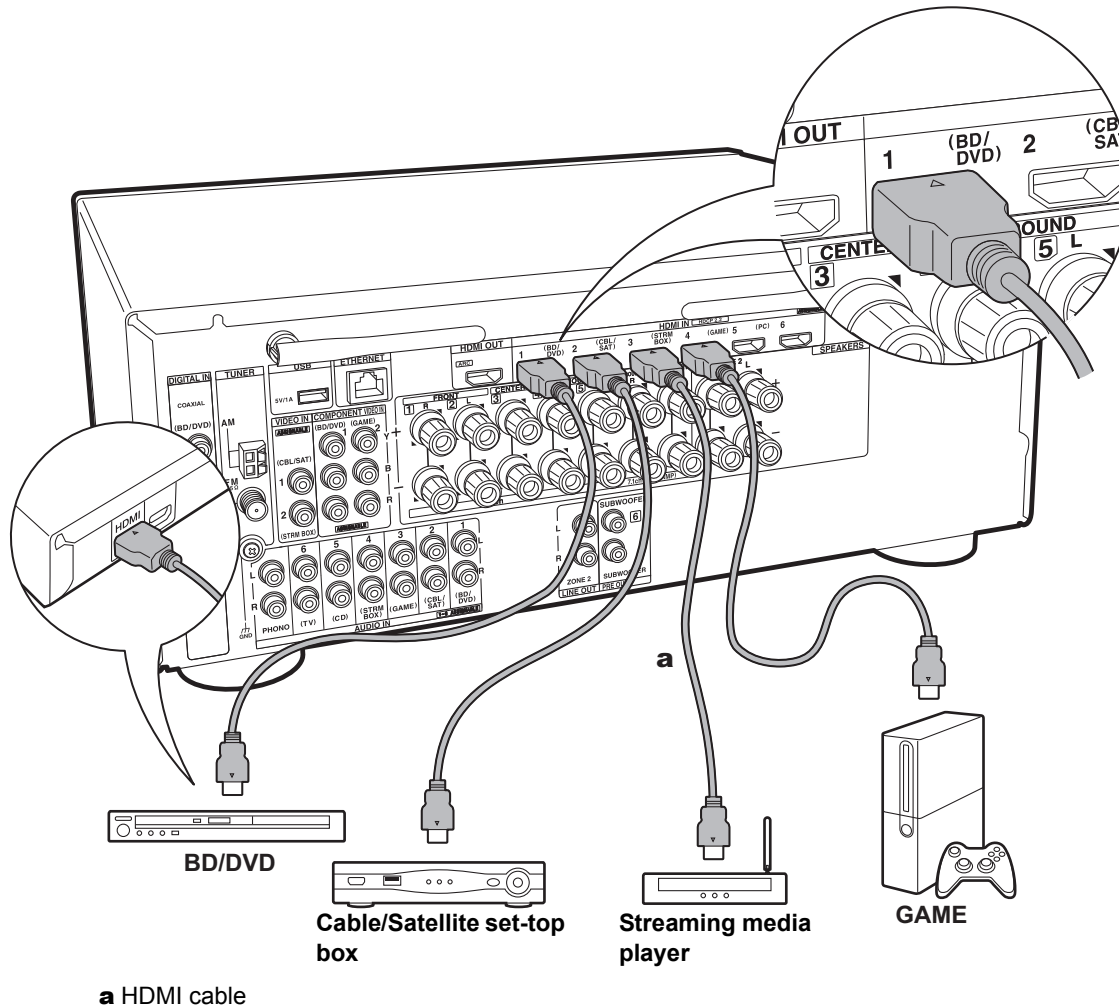

2. Connect the HDMI AV Component

This is an example of connection with an AV component that has an HDMI jack. With connection to an AV component that conforms with the CEC (Consumer Electronics Control) standard, you can use features such as the HDMI CEC feature (*) that links with the input selector, and the HDMI Standby Through feature which allows you to play video and audio from AV components on the TV even when this unit is in standby mode.

- To play 4K or 1080p video, use a high speed HDMI cable.



Setup

- When "Yes" is selected for "5. Audio Return Channel" in Initial Setup (P23), the HDMI CEC function and HDMI Standby Through function are automatically enabled. If "No, Skip" is selected, settings are required in the Setup menu after Initial Setup is complete. Press on the remote controller and make the settings in "5. Hardware" - "HDMI".
- To enjoy digital surround sound including Dolby Digital, audio output should be set to "Bitstream output" on the connected Blu-ray Disc player or other device.

(*)The HDMI CEC feature: You can control features such as linking input switching with the input selector and players conforming to the CEC standard, switching audio to output it from the TV or from this unit, and adjusting the volume using the remote controller of a CEC-compliant TV, and automatically switching this unit to standby when the TV is turned off.

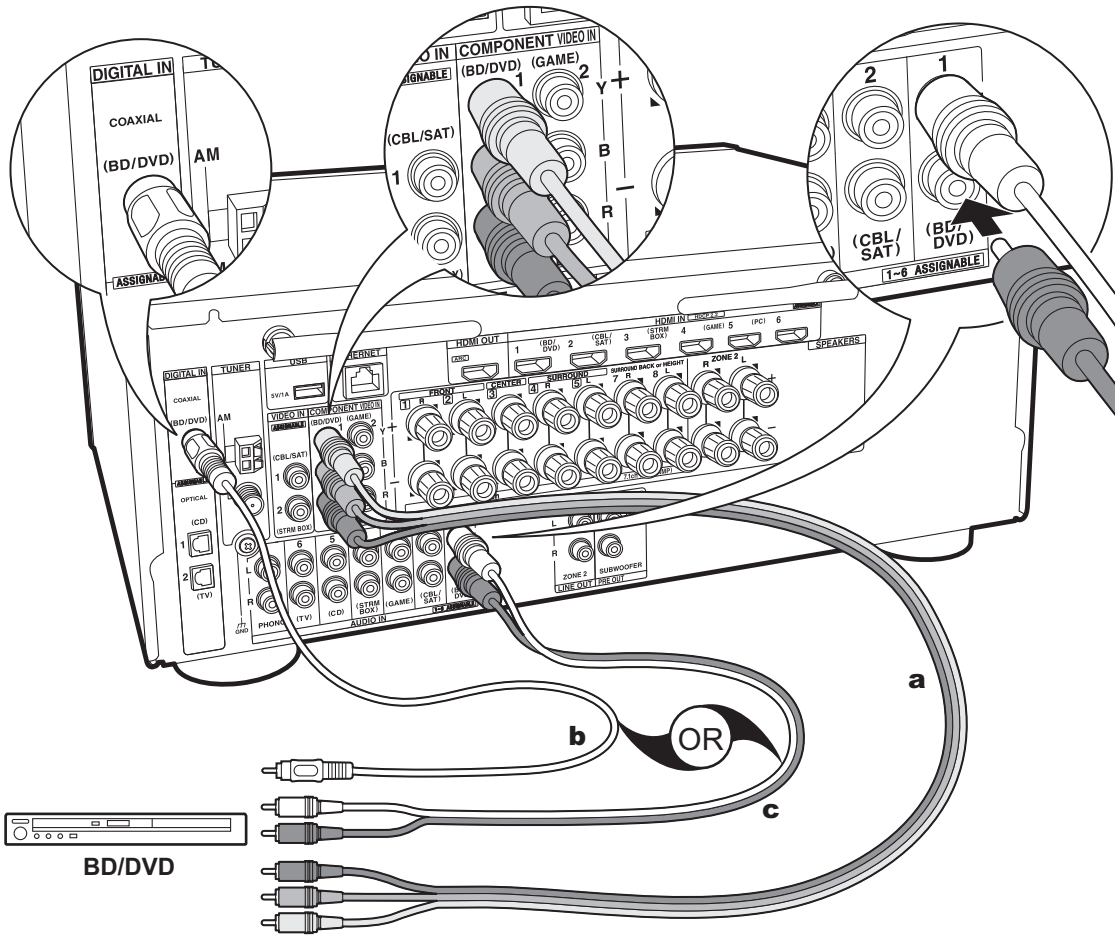

a Component video cable, **b** Digital coaxial cable, **c** Analog audio cable

3. Connect the Non-HDMI AV Component

This is an example of connection with an AV component that does not have an HDMI jack. Make the connections to the AV component to match the jacks it has. When video input connection is to the BD/DVD jack, the audio input connection should also be to the BD/DVD jacks, and so on, so that you connect the video input jacks to the jacks with the same name as the audio input jacks.

Note that video signals input to the VIDEO IN jack or the COMPONENT VIDEO IN jack will be converted to HDMI video signals and then output from the HDMI OUT jack.

- To enjoy digital surround playback in formats such as Dolby Digital, you need to make a connection for audio signals with a digital coaxial cable or a digital optical cable.
- It is possible to change assignment of the input jacks you see in the illustration at left, so you can also connect to any jack other than BD/DVD. For details, see the Advanced Manual.

Setup

- The COMPONENT VIDEO IN jacks are compatible only with 480i or 576i resolution. When you connect to the COMPONENT VIDEO IN jacks, set the output resolution of the player to 480i or 576i. Select interlace if there is no option for 480i, etc. If your player does not support 480i or 576i output, use the VIDEO IN jack.
- To enjoy digital surround sound including Dolby Digital, audio output should be set to "Bitstream output" on the connected Blu-ray Disc player or other device.

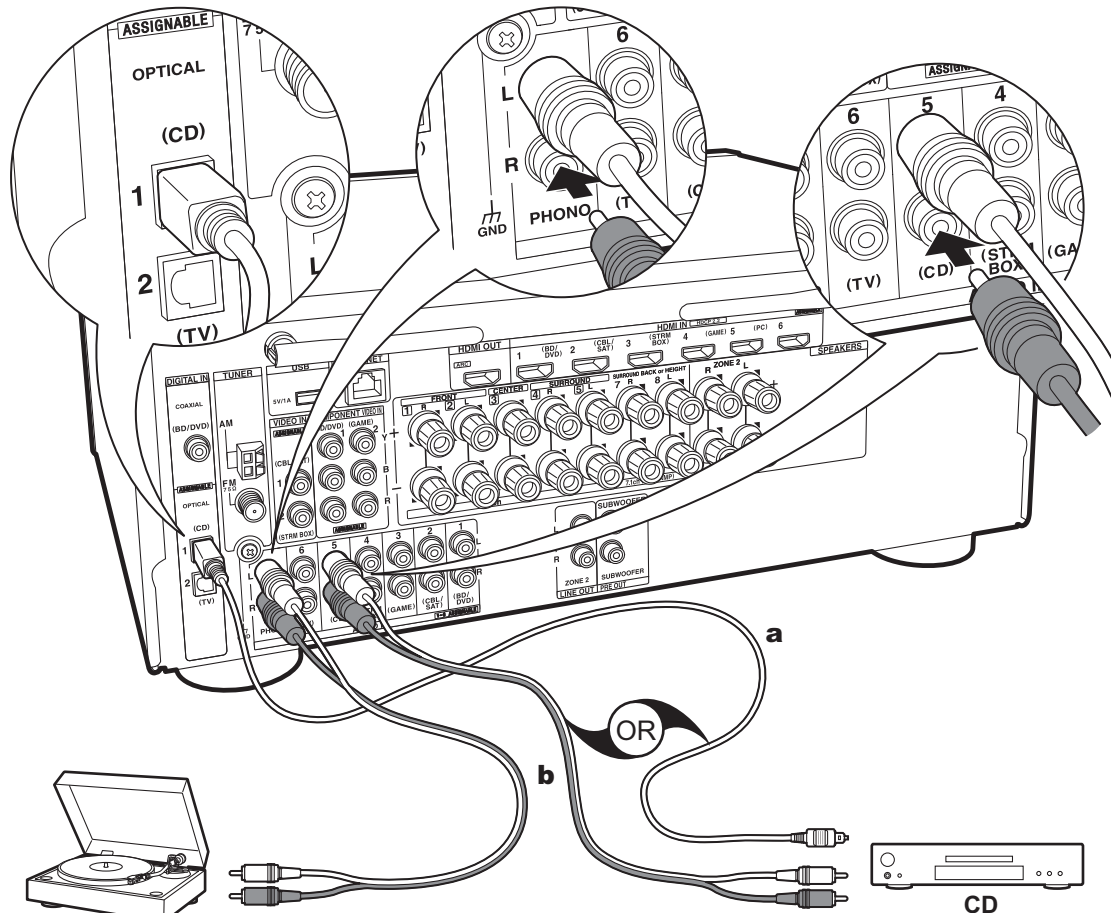

4. Connect the Audio Component

Example of a connection with an audio component. Connect a CD player using a digital optical cable or analog audio cable. You can also connect a turntable that has an MM-type cartridge to the PHONO jack.

- If the turntable has a built-in audio equalizer, connect it to another AUDIO IN jack. Further, if the turntable uses an MC type cartridge, install an audio equalizer compatible with the MC type cartridge between the unit and the turntable, then connect to any AUDIO IN jack other than the PHONO jack.

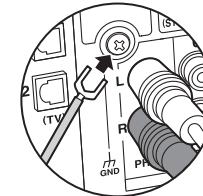

If the turntable has a ground wire, connect it to the GND terminal of this unit.

Turntable

CD

a Digital optical cable, **b** Analog audio cable

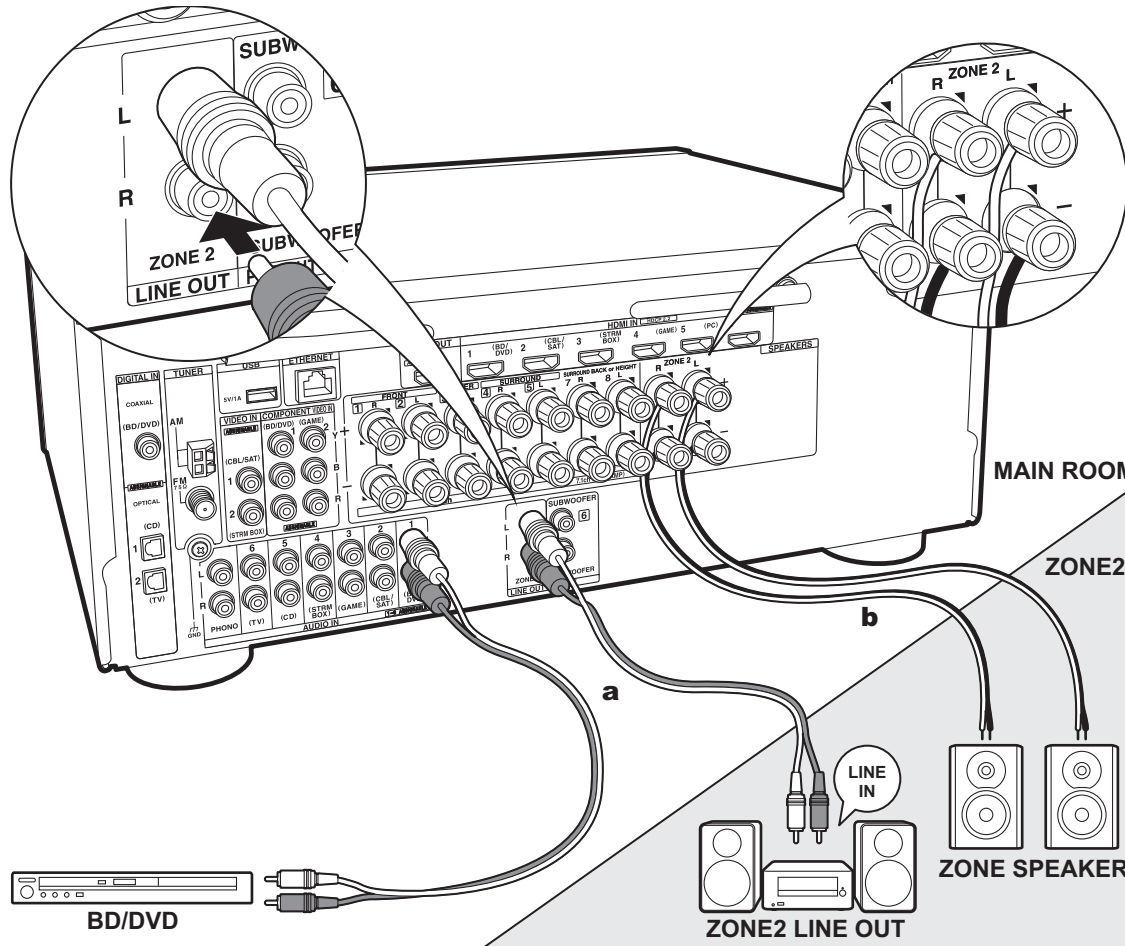

a Analog audio cable, **b** Speaker cable

5. Multi-zone Connection

You can enjoy audio in the separate room by, for example, playing a Blu-ray Disc player in the main room (where this unit is located) and listening to internet radio in the separate room (ZONE 2).

- DSD and Dolby TrueHD audio signals are not output to ZONE 2 when selected with the "NET" input selector.

Connections with an AV component

When outputting the audio of an external AV component to ZONE 2, connect using an analog audio cable.

ZONE 2 LINE OUT

It is possible to play 2 ch source in a separate room while 7.1 ch source is being played in the main room. Connect the ZONE 2 LINE OUT jacks of the unit and the LINE IN jacks of the pre-main amplifier in a separate room with an analog audio cable.

ZONE SPEAKER

It is possible to connect speakers in a separate room and play 2 ch sources.

- You cannot use ZONE SPEAKER if you have connected the front speakers using Bi-Amping connection.
- No sound is played from the surround back speakers or the height speakers when playing audio from ZONE SPEAKER.



Setup

- Settings are required in Initial Setup, "4. Multi Zone Setup" (P23) to enjoy this feature.

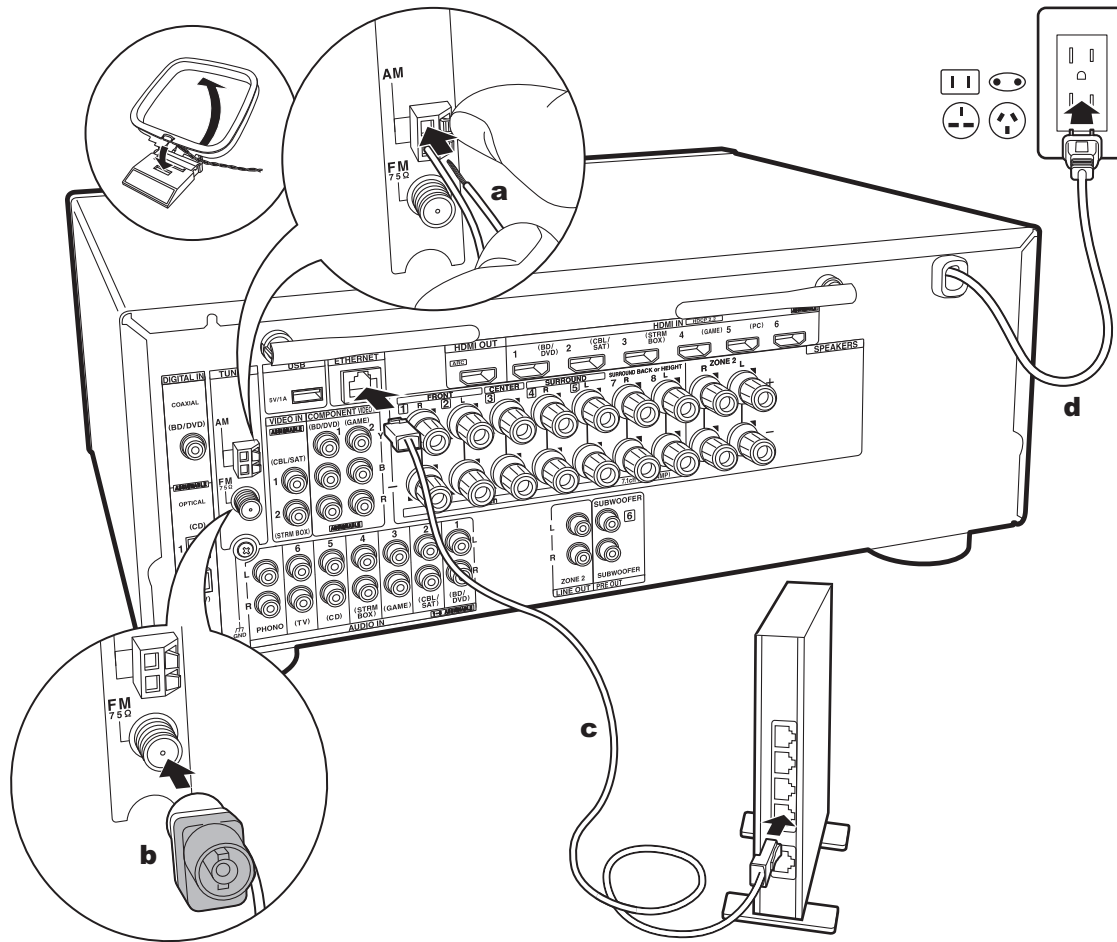

a AM loop antenna, **b** Indoor FM antenna, **c** Ethernet cable, **d** Power cord

6. Connect Other Cables

Antenna Hookup

Move the antenna around while playing the radio to find the position with the best reception. Use a thumb tack or similar to attach the indoor FM antenna to a wall.

Network Hookup

Connect this unit to the network using wired LAN or Wi-Fi (wireless LAN). You can enjoy network features such as internet radio by connecting the unit to the network. If you connect by wired LAN, connect with an Ethernet cable to the ETHERNET port as shown in the illustration. To connect by Wi-Fi, then after selecting "Wireless" in "3. Network Connection" (P23) in Initial Setup, select the desired setting method and follow the onscreen instructions to configure the connection.

Power Cord Hookup

The power cord must be connected only after all other cable connections are completed.



Initial Setup with Auto Start-up Wizard

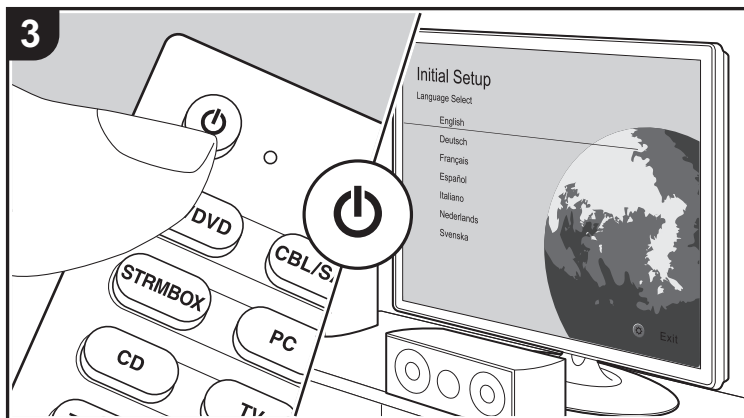
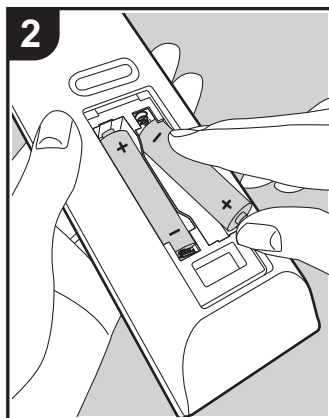
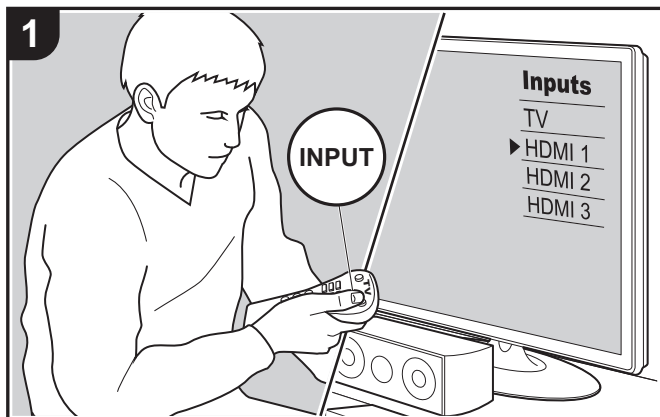

Initial Setup Starts Automatically

When you turn the unit on for the first time after purchasing it, Initial Setup is automatically shown on the TV to enable you to make settings required for startup using simple operations following onscreen guidance.

1. Switch the input on the TV to that assigned to the unit.
2. Put batteries into the remote controller of this unit.
3. Press on the remote controller to turn the unit on.
4. Select the item with the cursors of the remote controller and press ENTER (a) to confirm your selection. To return to the previous screen, press (b).

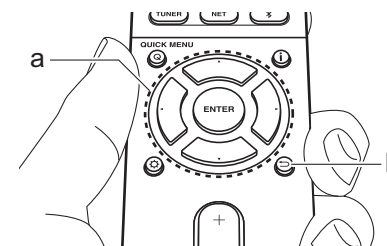

- If you terminate the procedure on the way or want to change a setting made during Initial Setup, press on the remote controller, select "7. Miscellaneous" – "Initial Setup", and press ENTER.

■ 1. AccuEQ Room Calibration

Place the supplied speaker setup microphone in the listening position, measure the test tones emitted by the speakers, then the unit automatically sets the optimum volume level for each speaker, the crossover frequencies, and the distance from the listening position. This also automatically adjusts the equalizers for the speakers and enables correction of distortion caused by the acoustic environment of the room.

- Calibration takes between 3 and 12 minutes to be completed.



The speakers emit the test tone at high volume during measurement, so be careful of your surroundings. Keep the room as quiet as possible during measurement.

- If you have connected a subwoofer, check the power and volume of the subwoofer. Set the subwoofer volume to more than halfway.
- If the power of this unit suddenly turns off, the wires in the speaker cables may have touch the rear panel or other wires and tripped the protection circuit. Twist the wires again properly and make sure they do not stick out of the speaker terminals when connecting.

1. Place the supplied speaker setup microphone in the listening position, and connect to the SETUP MIC jack on the main unit.

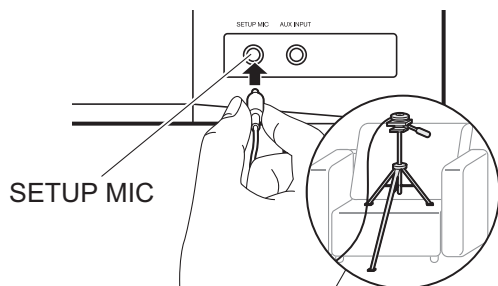

When putting the speaker setup microphone on a tripod, refer to the illustration when putting it in place.

2. Select the connected speaker configuration.

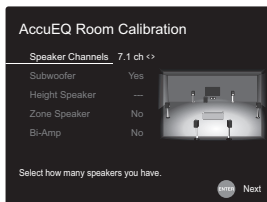

The image on the screen changes as you choose the number of channels in "Speaker Channels", so refer to it when performing the settings.

3. Test tones are emitted by the speakers, and firstly the unit detects the speakers connected and the noise in the environment.
4. After the results of the above measurements are displayed, select "Next", press ENTER on the remote controller, and the test tones are emitted again, and the unit automatically makes settings such as the optimum volume level and the crossover frequency.
5. When the measurement is completed, the measurement result is displayed. Press the cursors ◀ / ▶ on the remote controller to check the settings. Press ENTER when "Save" is selected to save the settings.
6. Select whether to enable or disable the equalizer function that corrects for distortion caused by the acoustic environment of the room. If this is to be enabled, then normally you should select "On (All Channels)", and to disable just the front speakers you should select "On (Except Front Left / Right)".
7. Disconnect the speaker setup microphone.

■ 2. Source Connection

Check that each input source is connected correctly. Follow the guidance, select the input you want to confirm, start play of the selected player, and confirm that the images appear on the TV and that sound is played.

■ 3. Network Connection

Set up Wi-Fi connection with an access point such as a wireless LAN router. There are the following two methods of connecting by Wi-Fi:

- "Scan Networks": Search for an access point from this unit. Find out the SSID of the access point beforehand.
- "Use iOS Device (iOS7 or later)": Share the iOS device's Wi-Fi settings with this unit.

If you select "Scan Networks", there are a further two choices of connection method. Check the following.

"Enter Password": Enter the password (or key) of the access point to connect.

"Push Button": If the access point has an automatic connection button, you can connect without entering a password.

- If the SSID of the access point is not displayed, then in the screen listing the SSIDs, select "Other..." with the ▶ cursor on the remote controller and press ENTER, then follow the onscreen instructions.

Keyboard Input

To switch between upper and lower case, select "A/a" on the screen and press ENTER. To select whether to mask the password with "*" or display it in plain text, press MEMORY on the remote controller. Press CLEAR to delete all the input characters.

- A confirmation screen asking you to agree to the privacy policy is displayed during network setting. Select "Accept" and press ENTER to indicate agreement.

■ 4. Multi Zone Setup

When you want to enjoy audio in a room other than the main room, set the audio output method for the separate room (ZONE 2). If you have connected speakers in a separate room with speaker cable, select "Using AV Receiver". If you have connected a pre-main amplifier in a separate room with an analog audio cable, select "with External Pre-main Amplifier".

■ 5. Audio Return Channel

If you have connected a TV that supports ARC, select "Yes". This unit's ARC setting turns on and you can listen to the TV's audio through this unit.

AV Component Playback

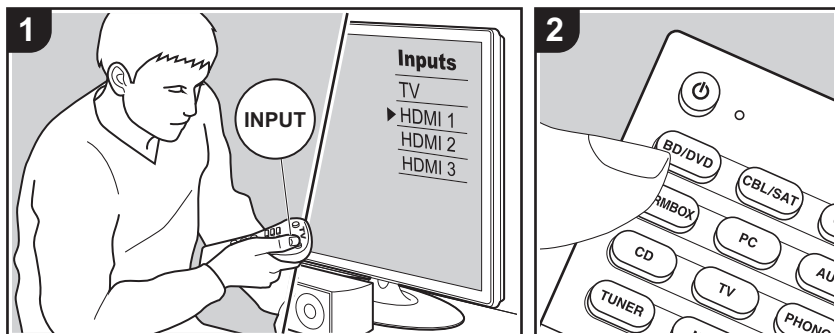

Basic Operations

You can play the audio from AV components such as Blu-ray Disc players through this unit.

Perform the following procedure when the unit is on.

1. Switch the input on the TV to that assigned to the unit.
2. Press the input selector (a) on the remote controller with the same name as the jack to which you connected the player to switch the input.
For example, press BD/DVD to play the player connected to the BD/DVD jack. Press TV to listen the TV's sound.
 - When the CEC link function works, the input switches automatically when you have connected a CEC compliant TV and player to this unit using HDMI connection.
3. Start play on the AV component.

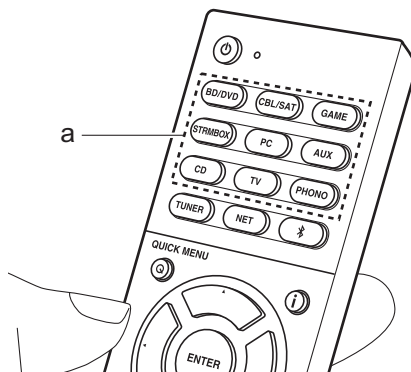

BLUETOOTH® Playback

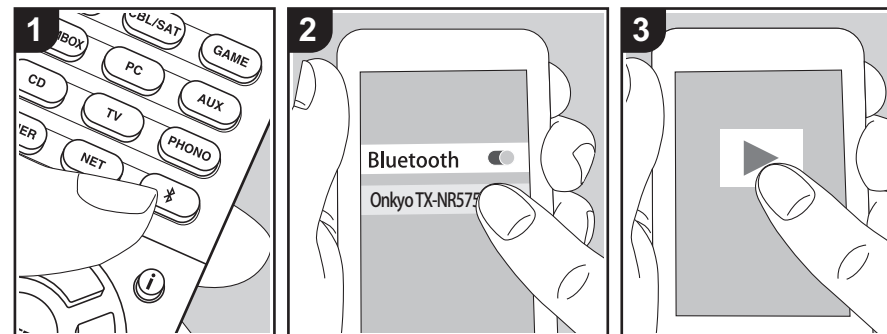

You can wirelessly play music on a smartphone or other BLUETOOTH wireless technology enabled device. Perform the following procedure when the unit is on.

Pairing

1. When you press the Bluetooth symbol button, "Now Pairing..." is displayed on this unit's display, and the pairing mode is enabled.

Now Pairing...

2. Enable (turn on) the BLUETOOTH function of the BLUETOOTH wireless technology enabled device, then select this unit from amongst the devices displayed. If a password is requested, enter "0000".
 - This unit is displayed as "Onkyo TX-NR575 XXXXXX".
 - To connect another BLUETOOTH wireless technology enabled device,

press and hold Bluetooth symbol button until "Now Pairing..." is displayed, then perform step 2. This unit can store the data of up to 8 paired devices.

- The coverage area is 48'/15 m. Note that connection is not always guaranteed with all BLUETOOTH wireless technology enabled devices.

Playing Back

1. Perform the connection procedure on the BLUETOOTH wireless technology enabled device.
The input on this unit automatically switches to "BLUETOOTH".
2. Play music. Increase the volume of the BLUETOOTH enabled device to an appropriate level.
 - Due to the characteristics of BLUETOOTH wireless technology, the sound produced on this unit may slightly be behind the sound played on the BLUETOOTH wireless technology enabled device.



Network Functions

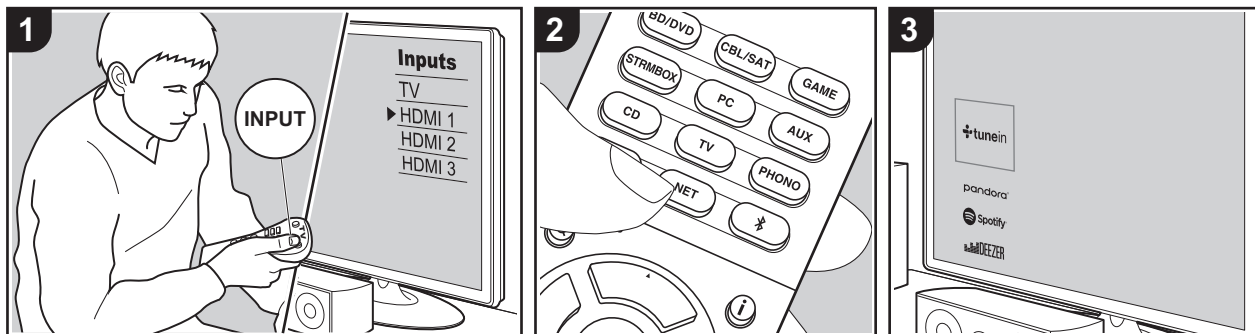

Basic Operations

By connecting this unit to the network you can enjoy internet radio services such as TuneIn, streaming from Spotify Connect, and wireless playback using AirPlay® features. Furthermore, you can use the Music Server feature to stream music files stored on PCs or NAS devices that support the home network feature. The basic operations for Network Functions are introduced in the Basic Manual. For more advanced operations, see the Advanced Manual. There may also be additional network functions provided through firmware updates for this unit. Also see the Advanced Manual for information about new features.

- The network needs to be connected to the internet in order to play internet radio services.
- Depending on the internet radio service, the user may need to register from their computer first.
- To enable Spotify Connect, install the

Spotify application on your smartphone or tablet and create a Spotify premium account.

- Refer to the following for Spotify settings:
www.spotify.com/connect/
- The network servers compatible with the Music Server feature are those PCs with players installed that have the server functionality of Windows Media® Player 11 or 12, or NAS that are compatible with home network functionality. Note that with PCs, only music files registered in the library of Windows Media® Player can be played.
- You may need to make some settings on the PC in advance to use Windows Media® Player 11 or 12 with the Music Server feature.

Perform the following procedure when the unit is on.

1. Switch the input on the TV to that assigned to the unit.
2. Press NET (a) on the remote controller

to display a list of Network Functions on the TV.

3. Select the Network Function with the cursors of the remote controller and press ENTER (b) to confirm your selection.

With internet radio services, follow the on-screen instructions, using the cursors to select radio stations and programs, then press ENTER to play. With Spotify or AirPlay, select this unit with your smartphone to play. With Music Server, select the server with the cursors, then select the desired music file and press ENTER to play.

- To return to the previous screen, press ↵ (c).

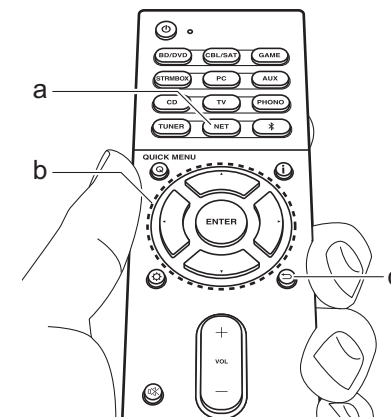



USB Storage Device

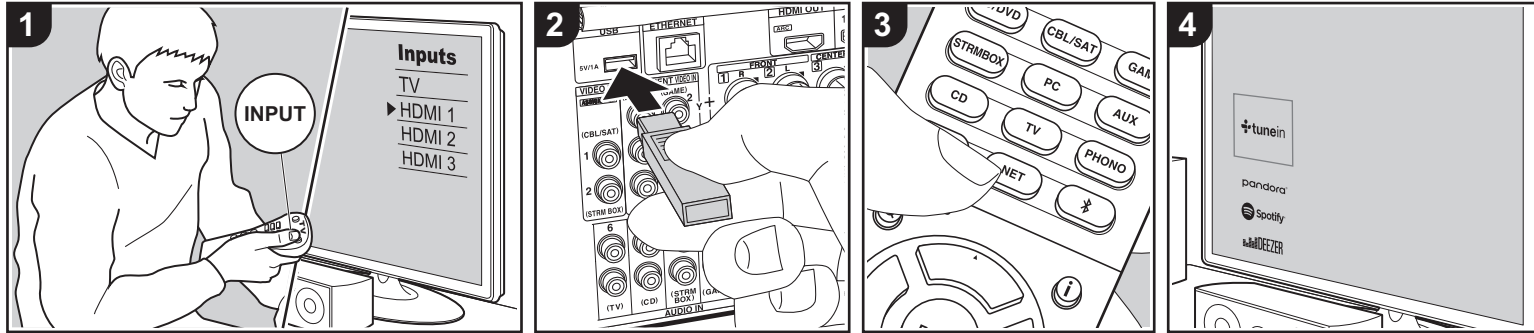

Basic Operations

You can play music files stored on a USB storage device.

Perform the following procedure when the unit is on.

1. Switch the input on the TV to that assigned to the unit.
2. Plug your USB storage device with the music files into the USB port of this unit's rear panel.
3. Press NET (a) on the remote controller to display the network service list screen.
4. With the cursors on the remote controller, select "USB", and then press ENTER (b).
 - If the "USB" indicator flashes on the display, check whether the USB storage device is plugged in properly.
 - Do not unplug the USB storage device while "Connecting..." is appeared on the display. This may cause data corruption or malfunction.

5. Press ENTER on the remote controller again in the next screen. The list of folders and music files on the USB storage device are displayed. Select the folder with the cursors and press ENTER to confirm your selection.
6. With the cursors on the remote controller, select the music file, and then press ENTER to start playback.
 - To return to the previous screen, press (c).
 - The USB port of this unit conforms with the USB 2.0 standard. The transfer speed may be insufficient for some content you play, which may cause some interruption in sound.
 - Operation cannot be guaranteed for all USB storage devices.
 - This unit can use USB storage devices that comply with the USB mass storage class standard. The unit is also compatible with USB storage devices using the FAT16 or FAT32 file system formats.

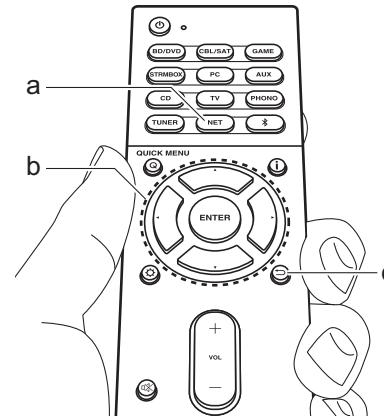



Listening to the AM/FM Radio

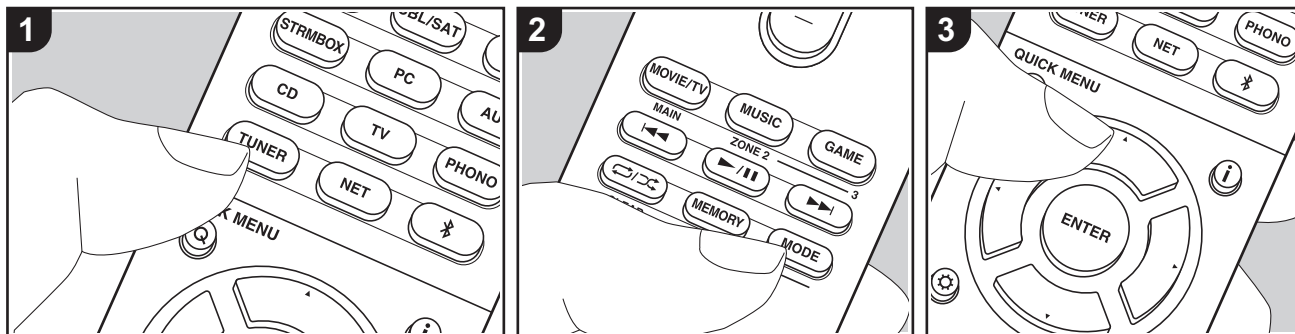

You can receive AM and FM radio stations on this unit with the built-in tuner. Perform the following procedure when the unit is on.

■ Tuning into a Radio Station

Tuning Automatically

1. Press TUNER (a) on the remote controller repeatedly to select either "AM" or "FM" on the display.
2. Press MODE (e) on the remote controller, so that the "TunMode: Auto" is displayed on the display.

TunMode:Auto

3. When you press the cursors ▲ / ▼ buttons (b) on the remote controller, automatic tuning starts, and searching stops when a station is found. When tuned into a radio station, the "TUNED" indicator on the display lights. When tuned into an FM stereo station, the "FM

ST" indicator lights.

When FM broadcasts reception is poor:

Perform the procedure for "Tuning Manually" in the following section. Note that if you tune manually, the reception for FM broadcasts will be monaural rather than stereo, irrespective of the sensitivity of the reception.

Tuning Manually

Note that if you tune manually, the reception for FM broadcasts will be monaural rather than stereo, irrespective of the sensitivity of the reception.

1. Press TUNER (a) on the remote controller repeatedly to select either "AM" or "FM" on the display.
2. Press MODE (e) on the remote controller, so that the "TunMode: Manual" is displayed on the display.

TunMode:Manual

3. While pressing the cursors ▲ / ▼ (b) on the remote controller, select the desired radio station.
 - The frequency changes by 1 step each time you press the cursors ▲ / ▼. The frequency changes continuously if the button is held down and stops when the button is released.

Frequency step setting:

Press the ⚙️ button, the cursor buttons and ENTER on the remote controller to select "7. Miscellaneous" – "Tuner" – "AM/FM Frequency Step" and select the frequency step for your area. Note that when this setting is changed, all radio presets are deleted.

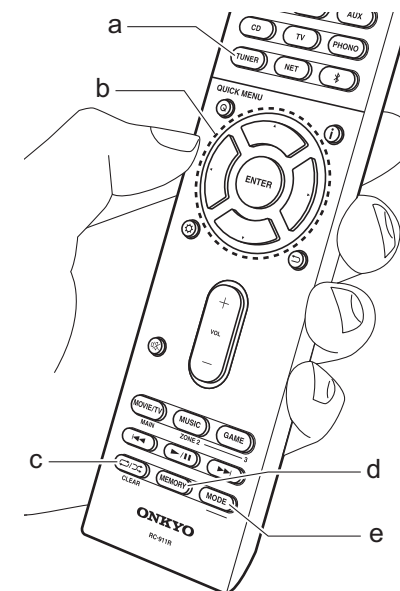

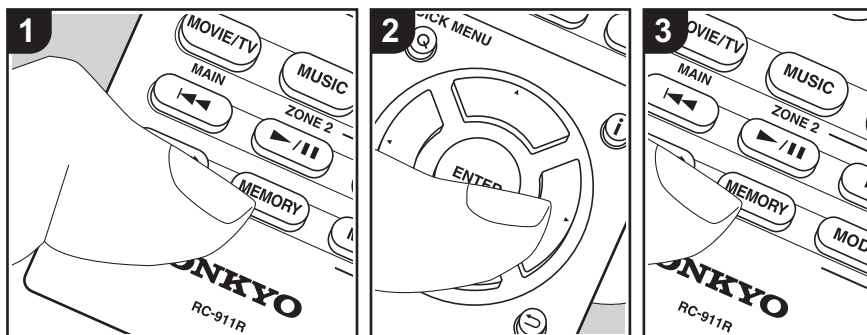

■ Presetting a Radio Station

You can preset up to 40 stations.

Registration Procedure

After tuning into the AM/FM radio station you want to register, perform the following procedure.

1. Press MEMORY (d) on the remote controller so that the preset number on the display flashes.

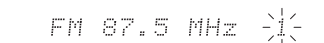

2. While the preset number is flashing (about 8 seconds), repeatedly press the cursors ◀ / ▶ (b) on the remote controller to select a number between 1 and 40.
3. Press MEMORY again on the remote controller to register the station. When registered, the preset number stops flashing. Repeat this procedure for all of your favorite AM/FM radio stations.

Selecting a Preset Radio Station

1. Press TUNER (a) on the remote controller.
2. Press cursors ◀ / ▶ (b) on the remote controller to select a preset number.

Deleting a Preset Radio Station

1. Press TUNER (a) on the remote controller.
2. Press cursors ◀ / ▶ (b) on the remote controller to select the preset number to delete.
3. After pressing MEMORY (d) on the remote controller, press CLEAR (c) while the preset number is flashing to delete the preset number. When deleted, the number on the display goes off.

Multi-zone

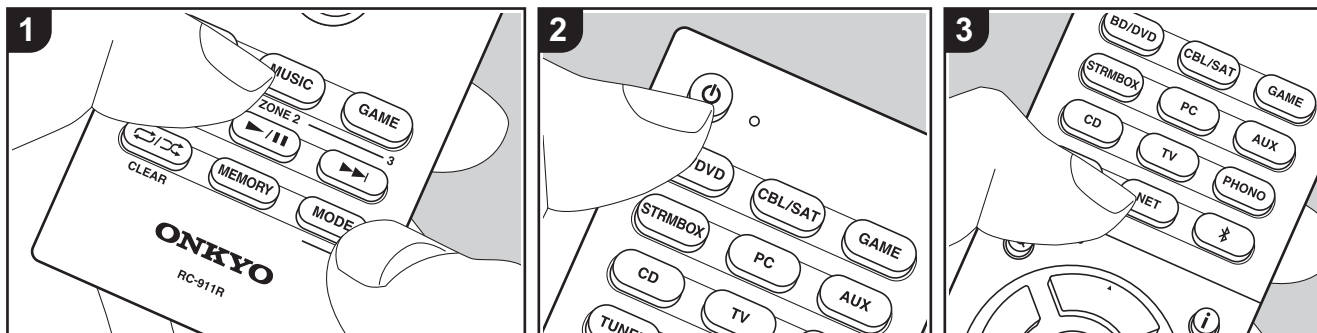

Basic Operations

You can enjoy audio in the separate room by, for example, playing a Blu-ray Disc player in the main room (where this unit is located) and listening to internet radio in the separate room (ZONE 2).

- DSD and Dolby TrueHD audio signals are not output to ZONE 2 when selected with the "NET" input selector.
- You can only select the same inputs for the main room and separate room with the "NET" or "BLUETOOTH" input selector. If you have "NET" selected in the main room and then select "BLUETOOTH" in the separate room, the main room also switches to "BLUETOOTH". You cannot select different stations for the main room and separate room with the AM/FM radio.
- If ZONE 2 is on, power consumption during standby becomes larger than normal.

Perform the following procedure when the

unit is on.

1. While holding down MODE (e) on the remote controller, press ZONE 2 (d) for 3 or more seconds until the remote indicator blinks twice.
 - The remote controller switches to the mode for controlling ZONE 2.
2. Point the remote controller at the main unit and press \downarrow (a). "Z2" lights on the main unit display.

Z2
3. Press the input selector button (b) of the input to be played in the separate room.
 - On the main unit, after pressing ZONE 2, within 8 seconds press the input selector button to select the input to be played in the separate room. To play the same source in the main room and separate room, press ZONE 2 on the main unit twice.
4. Volume adjustment is done on the pre-

main amplifier for the separate room when connected via ZONE 2 LINE OUT. When outputting from ZONE speakers, adjust with volume buttons on the remote controller.

- To control on the main unit, press ZONE 2 and adjust with the MASTER VOLUME control within 8 seconds.

To turn off the function:

Press \downarrow while in the mode for controlling ZONE 2 on the remote controller. Alternatively press OFF on the main unit.

Playing in ZONE 2 only:

If you turn the unit to standby during multi-zone playback, the Z2 indicator is dimmed and the playback mode is switched to playback in a separate room only. Setting ZONE 2 to on while this unit is in standby will also switch the playback mode to the same setting.

i To return the remote controller to main room control mode: While holding down MODE on the remote controller, press MAIN (c) for 3 seconds or more until the remote indicator flashes once.

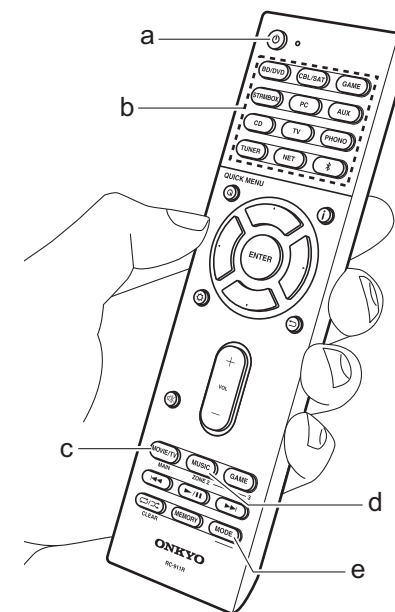



Listening Mode

This unit is equipped with a variety of listening modes, and you can select the optimum listening mode for movies, TV, music, and games using MOVIE/TV, MUSIC, and GAME (b). The basic operations are introduced in the Basic Manual. For more details, see the Advanced Manual.

- The listening mode last selected for the source is remembered for each of the MOVIE/TV, MUSIC, and GAME buttons. If content you play is not supported by the listening mode you selected last, the listening mode that is standard for that content is selected automatically.

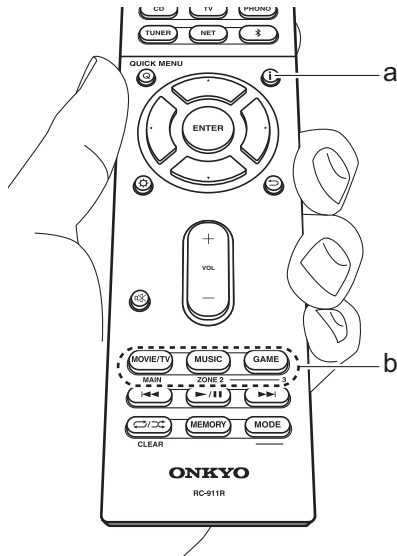

Dolby Digital/DTS Modes

When the input signal is a digital surround format such as Dolby Digital or DTS, you can select the listening mode that suits the input signal. Dolby Digital is displayed for Dolby Digital and DTS-HD Master Audio is displayed for DTS-HD Master Audio. The output is Stereo for 2-channel input signals.

Direct

This listening mode can be selected for all input signals. It shuts down processing that affects sound quality to deliver a playback sound quality closer to sources. Speakers play the sound field according to the number of channels in the input signal, so there would be output from only the front speakers for a 2 ch signal, for example.

Dolby Surround/DTS Neural:X

These listening modes allow you to expand the playback signal to 5.1 channels or 7.1 channels to suit the connected speaker configuration when the input signal is 2 channels or 5.1 channels.

Original Surround Modes

You can select listening modes such as the All Ch Stereo mode where a stereo image is played from both the front and the rear, and Orchestra (only with the MUSIC button) which is best for playback of classical and opera pieces.

Checking the Input Format and Listening Mode

Press **i** (a) on the remote controller several times to switch the display of the main unit as follows.

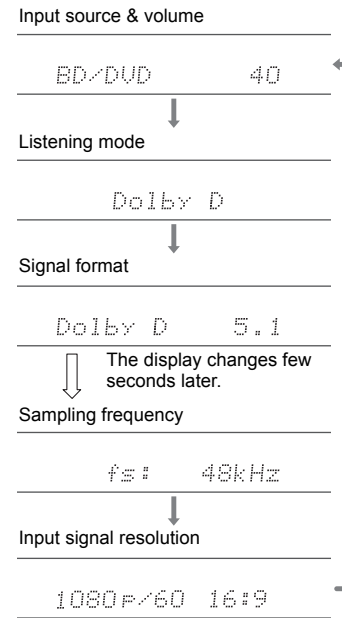

License and Trademark

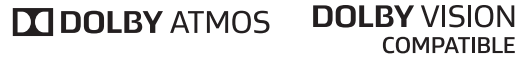

Manufactured under license from Dolby Laboratories. Dolby, Dolby Atmos, Dolby Surround, Dolby Vision and the double-D symbol are trademarks of Dolby Laboratories.



For DTS patents, see <http://patents.dts.com>. Manufactured under license from DTS, Inc. DTS, the Symbol, DTS in combination with the Symbol, DTS:X, and the DTS:X logo are registered trademarks or trademarks of DTS, Inc. in the United States and/or other countries. © DTS, Inc. All Rights Reserved.



The terms HDMI and HDMI High-Definition Multimedia Interface, and the HDMI Logo are trademarks or registered trademarks of HDMI Licensing LLC in the United States and other countries.



The Wi-Fi CERTIFIED Logo is a certification mark of Wi-Fi Alliance®.



AirPlay, iPad, iPhone, iPod, iPod classic, iPod nano and iPod touch are trademarks of Apple Inc., registered in the U.S. and other countries.

iPad Air and iPad mini are trademarks of Apple Inc.

"Made for iPod", "Made for iPhone" and "Made for iPad" mean that an electronic accessory has been designed to connect specifically to iPod, iPhone, or iPad, respectively, and has been certified by the developer to meet Apple performance standards. Apple is not responsible for the operation of this device or its compliance with safety and regulatory standards.

Please note that the use of this accessory with iPod, iPhone or iPad may affect wireless performance.

AirPlay works with iPhone, iPad, and iPod touch with iOS 4.3.3 or later, Mac with OS X Mountain Lion or later, and PC with iTunes 10.2.2 or later.



PANDORA, the PANDORA logo, and the Pandora trade dress are trademarks or registered trademarks of Pandora Media, Inc. Used with permission.



The BLUETOOTH® word mark and logos are registered trademarks owned by Bluetooth SIG, Inc.

The Spotify software is subject to third party licenses found here: <https://developer.spotify.com/esdk-third-party-licenses/>

This product is protected by certain intellectual property rights of Microsoft. Use or distribution of such technology outside of this product is prohibited without a license from Microsoft.

Windows 7, Windows Media, and the Windows logo are trademarks or registered trademarks of Microsoft Corporation in the United States and/or other countries.

DSD and the Direct Stream Digital logo are trademarks of Sony Corporation.



Theater-Dimensional

"Theater-Dimensional" and "Theater-Dimensional (logo)" are trademarks of Onkyo Corporation.

"All other trademarks are the property of their respective owners."

"Toutes les autres marques commerciales sont la propriété de leurs détenteurs respectifs."

"El resto de marcas comerciales son propiedad de sus respectivos propietarios".

"Tutti gli altri marchi di fabbrica sono di proprietà dei rispettivi proprietari."

"Alle anderen Warenzeichen sind das Eigentum ihrer jeweiligen Eigentümer."

"Alle andere handelsmerken zijn eigendom van de desbetreffende rechthebbenden."

"Alla andra varumärken tillhör deras respektive ägare."

"Kaikki muut tuotemerkit ovat omistajien omaisuutta."

ONKYO

1-10-5 Yokoami, Sumida-ku, Tokyo 130-0015 JAPAN
<http://www.onkyo.com/>

<U.S.A.>

18 Park Way, Upper Saddle River, N.J. 07458, U.S.A.
For Dealer, Service, Order and all other Business Inquiries:
Tel: 201-785-2600 Fax: 201-785-2650
<http://www.us.onkyo.com/>

For Product Support Team Only:
1-800-229-1687
<http://www.us.onkyo.com/>

<Germany>

Gutenbergstrasse 3, 82178 Puchheim, Germany
Tel: +49-8142-4401-0 Fax: +49-8142-4208-213
<http://www.eu.onkyo.com/>

<UK>

Anteros Building, Odyssey Business Park, West End Road, South Ruislip, Middlesex,
HA4 6QQ United Kingdom
Tel: +44 (0)871-200-1996 Fax: +44 (0)871-200-1995
For Product Support only: +44 (0)208-836-3510
<http://www.uk.onkyo.com/en/>

<France>

6, Avenue de Marais F - 95816 Argenteuil Cedex FRANCE
For Product Support only: +33 969 368 138
<http://www.fr.onkyo.com/fr/>

<Hong Kong>

Unit 1033, 10/F, Star House, No 3, Salisbury Road, Tsim Sha Tsui Kowloon, Hong Kong.
Tel: +852-2429-3118 Fax: +852-2428-9039
<http://www.hk.onkyo.com/>

<PRC>

302, Building 1, 20 North Chaling Rd., Xuhui District, Shanghai, China 200032,
Tel: +86-21-52131366 Fax: +86-21-52130396
<http://www.cn.onkyo.com/>

<Asia, Oceania, Middle East, Africa>

Please contact an Onkyo distributor referring to Onkyo SUPPORT site.
<http://www.intl.onkyo.com/support/>

The above-mentioned information is subject to change without prior notice.
Visit the Onkyo web site for the latest update.



Advanced Manual

Specifications	
General Specifications.....	2
About HDMI.....	4
Playback from USB storage devices.....	5
Playback from the Music Server.....	6
Advanced Setup	
Setup Menu.....	7
Quick Menu.....	26
Web Setup.....	27
Firmware Update.....	28
Listening Modes	
Selecting Listening Modes.....	31
Listening Mode Effects.....	32
Selectable Listening Modes.....	35
Network Functions	
Internet Radio.....	44
Spotify.....	45
AirPlay®.....	46
Music Server.....	47
Supplementary information for player functions.....	49
Troubleshooting	50
Supplementary Information, etc.	57

AV RECEIVER
TX-NR575
ONKYO

[The Basic Manual](#) includes information needed when starting up and also instructions for frequently used operations. [The Advanced Manual](#) has more detailed information and advanced settings.

General Specifications

■ Amplifier Section

Rated Output Power (FTC) (North American)

With 8 ohm loads, both channels driven, from 20-20,000 Hz; rated 80 watts per channel minimum RMS power, with no more than 0.08% total harmonic distortion from 250 milliwatts to rated output.

Surround Mode Output Power (*)

(6 ohms, 1 kHz THD 0.9%) 140 W per channel

* Reference output for each speakers.

Depending on the source and the listening mode settings, there may be no sound output.

Maximum Effective Output Power (JEITA) (North American)

7 ch × 170 W at 6 ohms, 1 kHz, 1 ch driven of 10% THD

Dynamic Power (*)

* IEC60268-Short-term maximum output power

160 W (3 Ω, Front)

125 W (4 Ω, Front)

85 W (8 Ω, Front)

THD+N (Total Harmonic Distortion+Noise)

0.08% (20 Hz - 20,000 Hz, half power)

Input Sensitivity and Impedance (1 kHz 100 W/8 Ω)

200 mV/47 kΩ (LINE (Unbalance))

3.5 mV/47 kΩ (PHONO MM)

Rated RCA Output Level and Impedance

1 V/470 Ω (SUBWOOFER PRE OUT)

200 mV/2.3 kΩ (ZONE LINE OUT)

Phono Overload

70 mV (MM 1 kHz 0.5%)

Frequency Response

10 Hz - 100 kHz/+1 dB, -3 dB (Direct)

Tone Control Characteristics

±10 dB, 90 Hz (BASS)

±10 dB, 7.5 kHz (TREBLE)

Signal to Noise Ratio

106 dB (IHF-A, LINE IN, SP OUT)

80 dB (IHF-A, PHONO IN, SP OUT)

Speaker Impedance

4 Ω - 16 Ω

Headphone Output Impedance

330 Ω

Headphone Rated Output

80 mW (32 Ω, 1 kHz, 10% THD)

■ Video Section

Signal level

1 Vp-p/75 Ω (Composite Video)

1 Vp-p/75 Ω (Component Video Y)

0.7 Vp-p/75 Ω (Component Video B/R)

Maximum resolution supported by component video

480i/576i

■ Tuner Section

FM Tuning Frequency Range

87.5 MHz - 107.9 MHz

AM Tuning Frequency Range

530 kHz - 1710 kHz

Preset Channel

40

■ Network Section

Ethernet LAN

10BASE-T/100BASE-TX

Wireless LAN

IEEE 802.11 a/b/g/n standard

(Wi-Fi® standard)

5 GHz/2.4 GHz band

■ BLUETOOTH Section

Communication system

BLUETOOTH Specification version 4.1+LE

Frequency band

2.4 GHz band

Modulation method

FHSS (Freq Hopping Spread Spectrum)

Compatible BLUETOOTH profiles

A2DP 1.2

AVRCP 1.3

HOGP-Host (Client)

HOGP-HID Device (Server)

HID Service (HIDS)

Supported Codecs

SBC

AAC

Transmission range (A2DP)

20 Hz - 20 kHz (Sampling frequency 44.1 kHz)

Maximum communication range

Line of sight approx. 15 m (*)

* The actual range will vary depending on factors such as obstacles between devices, magnetic fields around a microwave oven, static electricity, cordless phone, reception sensitivity, antenna's performance, operating system, software application, etc.

■ General

Power Supply

AC 120 V, 60 Hz

Power Consumption

460 W

0.15 W (Stand-by)

55 W (No-sound)

5.5 W (HDMI Standby Through)

2.6 W (Network Standby)

Dimensions (W × H × D)

435 mm × 173.5 mm × 378 mm

17-1/8" × 6-13/16" × 14-7/8"

Weight

9.4 kg (20.7 lbs.)

■ HDMI

Input

IN1 (BD/DVD), IN2 (CBL/SAT), IN3 (STRM BOX), IN4 (GAME), IN5 (PC), IN6

Output

OUT

Supported

Deep Color, x.v.Color™, LipSync, Audio Return Channel, 3D, 4K 60 Hz, CEC, Extended Colorimetry (sYCC601, Adobe RGB, Adobe YCC601), Content Type, HDR

Audio Format

Dolby Atmos, Dolby TrueHD, Dolby Digital, Dolby Digital Plus, DTS, DTS:X, DTS-HD Master Audio, DTS-HD High Resolution Audio, DTS 96/24, DTS-ES, DTS-HD Express, DSD, PCM

Maximum Video Resolution

4k 60 Hz (YCbCr 4:4:4)

■ Video Inputs

Component

IN1 (BD/DVD), IN2 (GAME)

Composite

IN1 (CBL/SAT), IN2 (STRM BOX)

■ Compatible input resolutions

HDMI input

4K, 1080p/24, 1080p, 1080i, 720p, 480p/576p

Component input

480i/576i

Composite input

480i/576i

- The output from the HDMI OUT jack to the TV is the same resolution as the input.

■ Audio Inputs

Digital

OPTICAL 1 (CD), 2 (TV)

COAXIAL (BD/DVD)

Analog

BD/DVD, CBL/SAT, GAME, STRM BOX, CD, TV, PHONO, AUX (front)

■ Audio Outputs

Analog

ZONE2 LINE OUT

2 SUBWOOFER PRE OUT

Speaker Outputs

FRONT L/R, CENTER, SURROUND L/R,

SURROUND BACK or HEIGHT L/R, ZONE2 L/R

(Banana plug ready)

Phones

PHONES (Front, ø 6.3 mm, 1/4")

■ Others

Setup Mic : 1 (Front)

USB : 1 (Ver. 2.0, 5 V/1 A)

Ethernet : 1

■ Power consumption in standby mode

- In the following cases, the power consumption in standby mode may reach up to a maximum of 12 W:
 - When "Network Standby" is set to "On"
 - When "HDMI CEC" is set to "On"
 - When "HDMI Standby Through" is set to other than "Off"
 - When "Bluetooth Wakeup" is set to "On"
 - When "USB Power Out at Standby" is set to "On"

Specifications and features are subject to change without notice.

About HDMI

Compatible functions

HDMI (High Definition Multimedia Interface) is a digital interface standard for connecting TVs, projectors, Blu-ray Disc/DVD players, set-top boxes, and other video components. Until now, several separate video and audio cables have been required to connect AV components. With HDMI, a single cable can carry control signals, digital video and digital audio (2 ch PCM, multichannel digital audio, and multichannel PCM).

HDMI CEC functionality:

By connecting devices and HDMI cables that comply with the CEC (Consumer Electronics Control) specification of the HDMI standard, a variety of linked operation become possible between devices. You can enjoy features such as linking input switching with the input selector and players, control volume using the remote controller of the TV, and automatically switching this unit to standby when the TV is turned off.

The unit is designed to link with products that comply with the CEC standard, and that linked operation is not always guaranteed with all CEC devices. For linked functions to work properly, do not connect more CEC-compliant components than the quantities specified below, to the HDMI jack.

- Blu-ray Disc/DVD players: up to 3 units.
- Blu-ray Disc/DVD recorders: up to 3 units.
- Cable TV tuner, terrestrial digital tuner, and satellite broadcasting tuner: up to 4 units.

Operation has been confirmed on the following devices:
(As of February 2017)

Toshiba brand televisions; Sharp brand televisions; Onkyo and Integra brand RIHD-compatible players; Toshiba brand players and recorders; Sharp brand players and recorders (when used with a Sharp brand television)

ARC (Audio Return Channel):

By connection a TV that supports ARC with a single HDMI cable, you can not only output the audio and video from this unit to the TV, but also input the audio from the TV to this unit.

HDMI Standby Through:

Even if this unit is in standby, the input signals from AV components are transmitted to the TV.

Deep Color:

By connecting devices supporting Deep Color, video signals input from the devices can be reproduced on the TV with even more colors.

x.v.Color™:

This technology realizes even more realistic colors by broadening the color gamut.

3D:

You can transmit 3D video signals from AV components to the TV.

4K:

This unit supports 4K (3840 × 2160p) and 4K SMPTE (4096 × 2160p) video signals.

LipSync:

This setting automatically corrects any desynchronization between the video and audio signals based on data from the HDMI LipSync compatible TV.

Copyright Protection:

The unit supports Revision 1.4 and Revision 2.2 of the HDCP (High-bandwidth Digital Content Protection), a copy-protection system for digital video signals. Other devices connected to the unit must also support HDCP.

Supported Audio Formats

2 ch linear PCM:

32 kHz, 44.1 kHz, 48 kHz, 88.2 kHz, 96 kHz, 176.4 kHz, 192 kHz, 16/20/24 bit

Multi-channel linear PCM:

Maximum 7.1 channels, 32 kHz, 44.1 kHz, 48 kHz, 88.2 kHz, 96 kHz, 176.4 kHz, 192 kHz, 16/20/24 bit

Bitstream:

Dolby Atmos, Dolby Digital, Dolby Digital Plus, Dolby TrueHD, DTS, DTS:X, DTS-HD High Resolution Audio, DTS-HD Master Audio

DSD:

Supported sampling rates: 2.8 MHz

Your Blu-ray Disc/DVD player must also support HDMI output of the above audio formats.

Supported resolutions

- Copyright protection technology: HDCP1.4/HDCP2.2
- Color space (Color Depth):
 - 720 × 480i 60Hz, 720 × 576i 50Hz, 720 × 480p 60Hz, 720 × 576p 50Hz, 1920 × 1080i 50/60Hz, 1280 × 720p 24/25/30/50/60Hz, 1680 × 720p 24/25/30/50/60Hz, 1920 × 1080p 24/25/30/50/60Hz, 2560 × 1080p 24/25/30/50/60Hz, 4K (3840 × 2160p) 24/25/30Hz, 4K SMPTE (4096 × 2160p) 24/25/30Hz : RGB/YCbCr4:4:4 (8/10/12 bit), YCbCr4:2:2 (12 bit)
 - 4K (3840 × 2160p) 50/60Hz, 4K SMPTE (4096 × 2160p) 50/60Hz : RGB/YCbCr4:4:4 (8 bit), YCbCr4:2:2 (12 bit), YCbCr4:2:0 (8/10/12 bit)

Playback from USB storage devices

■ USB Storage Device Requirements

- This unit can use USB storage devices that comply with the USB mass storage device class standard.
- FAT16 or FAT32 file system format.
- If the USB storage device has been partitioned, each section will be treated as an independent device.
- Up to 20,000 tracks per folder can be displayed, and folders may be nested up to 16 levels deep.
- USB hubs and USB storage devices with hub functions are not supported. Do not connect these devices to the unit.
- USB storage devices with security function are not supported on this unit.
- If you connect a USB hard disk drive to the USB port of the unit, we recommend that you use its AC adapter to power it.
- Media inserted to the USB card reader may not be available in this function. Furthermore, depending on the USB storage device, proper reading of the contents may not be possible.
- Our company accepts no responsibility whatsoever for the loss or damage to data stored on a USB storage device when that device is used with this unit. We recommend that you back up your important music files beforehand.

■ Supported Audio Formats

This unit supports the following music file formats. Note that sound files that are protected by copyright cannot be played on this unit.

MP3 (.mp3/.MP3):

- Supported formats: MPEG-1/MPEG-2 Audio Layer 3

- Supported sampling rates: 44.1 kHz, 48 kHz
- Supported bitrates: Between 8 kbps and 320 kbps.

WMA (.wma/.WMA):

- Supported sampling rates: 44.1 kHz, 48 kHz
- Supported bitrates: Between 5 kbps and 320 kbps.
- WMA Pro/Voice/WMA Lossless formats are not supported

WAV (.wav/.WAV):

WAV files include uncompressed PCM digital audio.

- Supported sampling rates: 44.1 kHz, 48 kHz, 88.2 kHz, 96 kHz, 176.4 kHz, 192 kHz
- Quantization bit: 8 bit, 16 bit, 24 bit

AIFF (.aiff/.aif/.AIFF/.AIF):

AIFF files include uncompressed PCM digital audio.

- Supported sampling rates: 44.1 kHz, 48 kHz, 88.2 kHz, 96 kHz, 176.4 kHz, 192 kHz
- Quantization bit: 8 bit, 16 bit, 24 bit

AAC (.aac/.m4a/.mp4/.3gp/.3g2/.AAC/.M4A/.MP4/.3GP/.3G2):

- Supported formats: MPEG-2/MPEG-4 Audio
- Supported sampling rates: 44.1 kHz, 48 kHz, 88.2 kHz, 96 kHz
- Supported bitrates: Between 8 kbps and 320 kbps.

FLAC (.flac/.FLAC):

- Supported sampling rates: 44.1 kHz, 48 kHz, 88.2 kHz, 96 kHz, 176.4 kHz, 192 kHz
- Quantization bit: 8 bit, 16 bit, 24 bit

Apple Lossless (.m4a/.mp4/.M4A/.MP4):

- Supported sampling rates: 44.1 kHz, 48 kHz, 88.2 kHz, 96 kHz, 176.4 kHz, 192 kHz
- Quantization bit: 16 bit, 24 bit

DSD (.dsf/.dff/.DSF/.DFF):

- Supported formats: DSF/DSDIFF
- Supported sampling rates: 2.8 MHz, 5.6 MHz

Dolby TrueHD (.vr/.mlp/.VR/.MLP):

- Supported sampling rates: 44.1 kHz, 48 kHz, 88.2 kHz, 96 kHz, 176.4 kHz, 192 kHz

- Variable bit-rate (VBR) files are supported. However,

- playback times may not be displayed correctly.
- This unit supports the gapless playback of the USB storage device in the following conditions. When playing WAV, FLAC and Apple Lossless, and the same format, sampling frequency, channels and quantization bit rate are played continuously.

Playback from the Music Server

■ Supported Audio Formats

This unit supports the following music file formats. Remote play of FLAC and DSD is not supported.

MP3 (.mp3/.MP3):

- Supported formats: MPEG-1/MPEG-2 Audio Layer 3
- Supported sampling rates: 44.1 kHz, 48 kHz
- Supported bitrates: Between 8 kbps and 320 kbps.

WMA (.wma/.WMA):

- Supported sampling rates: 44.1 kHz, 48 kHz
- Supported bitrates: Between 5 kbps and 320 kbps.
- WMA Pro/Voice/WMA Lossless formats are not supported

WAV (.wav/.WAV):

WAV files include uncompressed PCM digital audio.

- Supported sampling rates: 44.1 kHz, 48 kHz, 88.2 kHz, 96 kHz, 176.4 kHz, 192 kHz
- Quantization bit: 8 bit, 16 bit, 24 bit

AIFF (.aiff/.aif/.AIFF/.AIF):

AIFF files include uncompressed PCM digital audio.

- Supported sampling rates: 44.1 kHz, 48 kHz, 88.2 kHz, 96 kHz, 176.4 kHz, 192 kHz
- Quantization bit: 8 bit, 16 bit, 24 bit

AAC (.aac/.m4a/.mp4/.3gp/.3g2/.AAC/.M4A/.MP4/.3GP/.3G2):

- Supported formats: MPEG-2/MPEG-4 Audio
- Supported sampling rates: 44.1 kHz, 48 kHz, 88.2 kHz, 96 kHz
- Supported bitrates: Between 8 kbps and 320 kbps.

FLAC (.flac/.FLAC):

- Supported sampling rates: 44.1 kHz, 48 kHz, 88.2 kHz, 96 kHz, 176.4 kHz, 192 kHz
- Quantization bit: 8 bit, 16 bit, 24 bit

LPCM (Linear PCM):

- Supported sampling rates: 44.1 kHz, 48 kHz
- Quantization bit: 16 bit

Apple Lossless (.m4a/.mp4/.M4A/.MP4):

- Supported sampling rates: 44.1 kHz, 48 kHz, 88.2 kHz, 96 kHz
- Quantization bit: 16 bit, 24 bit

DSD (.dsf/.dff/.DSF/.DFF):

- Supported formats: DSF/DSDIFF
- Supported sampling rates: 2.8 MHz, 5.6 MHz

- Variable bit-rate (VBR) files are supported. However, playback times may not be displayed correctly.
- Remote playback does not support the gapless playback.



Setup Menu



The unit allows you to configure advanced settings to provide you with an even better experience.



Operation:

Use the on-screen displays (OSD) that appear on the TV to make the settings. Press  on the remote controller to display the Setup menu.



Select the item with the cursor / buttons of the remote controller and press ENTER to confirm your selection.

Use the cursors / to change the default values.

- To return to the previous screen, press .
- To exit the settings, press .

1. Input/Output Assign

Make settings related to output to the TV, change the settings for jack allocations to the various input selectors, and set the feature for displaying operations on the TV (OSD), etc.

■ 1. TV Out / OSD

Setting Item	Default Value	Setting Details
OSD Language	English	Select the on-screen display language from the following. English, German, French, Spanish, Italian, Dutch, Swedish
Impose OSD	On	Set whether or not to display the information on the TV when the volume is adjusted or input is changed, for example. "On": OSD displayed on the TV. "Off": OSD not displayed on the TV. • OSD may not be displayed depending on the input signal even if "On" is selected. If the operation screen is not displayed, change the resolution of the connected device.

Setting Item	Default Value	Setting Details
Mini Player OSD	Always On	<p>You can play on the TV the images from another input selected immediately prior while you are playing the audio from NET or BLUETOOTH input. After switching to NET or BLUETOOTH, play the images and audio, then when you press MODE on the remote controller, the image is displayed in full-screen mode, and the audio information (Mini Player) for NET or BLUETOOTH is displayed in the corner of the screen. You can set whether to display this Mini Player on the screen all the time.</p> <p>"Always On": The Mini Player is displayed all the time.</p> <p>"Auto Off": The Mini Player turns off automatically 30 seconds after being displayed. It is displayed for 30 seconds after operations such as changing the volume.</p> <ul style="list-style-type: none"> • Each press of the MODE button displays or turns off the video. • This cannot be selected if "Impose OSD" is set to "Off".
Screen Saver	3 minutes	<p>Set the time to start the screen saver. Select a value from "3 minutes", "5 minutes", "10 minutes" and "Off".</p>

■ 2. HDMI Input

You can change input assignment between the input selectors and HDMI IN jacks.

Setting Item	Default Value	Setting Details
BD/DVD	HDMI 1 (HDCP 2.2)	"HDMI 1 (HDCP 2.2)" to "HDMI 6 (HDCP 2.2)": Assign a desired HDMI IN jack to the BD/DVD button. If you do not assign a jack, select "---". To select an HDMI IN jack already assigned to another input selector, change its setting to "---" first.
CBL/SAT	HDMI 2 (HDCP 2.2)	"HDMI 1 (HDCP 2.2)" to "HDMI 6 (HDCP 2.2)": Assign a desired HDMI IN jack to the CBL/SAT button. If you do not assign a jack, select "---". To select an HDMI IN jack already assigned to another input selector, change its setting to "---" first.
GAME	HDMI 4 (HDCP 2.2)	"HDMI 1 (HDCP 2.2)" to "HDMI 6 (HDCP 2.2)": Assign a desired HDMI IN jack to the GAME button. If you do not assign a jack, select "---". To select an HDMI IN jack already assigned to another input selector, change its setting to "---" first.
STRM BOX	HDMI 3 (HDCP 2.2)	"HDMI 1 (HDCP 2.2)" to "HDMI 6 (HDCP 2.2)": Assign a desired HDMI IN jack to the STRM BOX button. If you do not assign a jack, select "---". To select an HDMI IN jack already assigned to another input selector, change its setting to "---" first.
PC	HDMI 5 (HDCP 2.2)	"HDMI 1 (HDCP 2.2)" to "HDMI 6 (HDCP 2.2)": Assign a desired HDMI IN jack to the PC button. If you do not assign a jack, select "---". To select an HDMI IN jack already assigned to another input selector, change its setting to "---" first.
CD	---	"HDMI 1 (HDCP 2.2)" to "HDMI 6 (HDCP 2.2)": Assign a desired HDMI IN jack to the CD button. If you do not assign a jack, select "---". To select an HDMI IN jack already assigned to another input selector, change its setting to "---" first.

Setting Item	Default Value	Setting Details
TV	---	"HDMI 1 (HDCP 2.2)" to "HDMI 6 (HDCP 2.2)": Assign a desired HDMI IN jack to the TV button. If you do not assign a jack, select "---". To select an HDMI IN jack already assigned to another input selector, change its setting to "---" first.
PHONO	---	"HDMI 1 (HDCP 2.2)" to "HDMI 6 (HDCP 2.2)": Assign a desired HDMI IN jack to the PHONO button. If you do not assign a jack, select "---". To select an HDMI IN jack already assigned to another input selector, change its setting to "---" first.

■ 3. Video Input

You can change input assignment between the input selectors and COMPONENT VIDEO IN jacks and the VIDEO IN jacks. If you do not assign a jack, select "---".

Setting Item	Default Value	Setting Details
BD/DVD	COMPONENT 1	"COMPONENT 1", "COMPONENT 2": Assign the COMPONENT VIDEO IN jacks to the BD/DVD button. "VIDEO 1", "VIDEO 2": Assign a desired VIDEO IN jack to the BD/DVD button.
CBL/SAT	VIDEO 1	"COMPONENT 1", "COMPONENT 2": Assign the COMPONENT VIDEO IN jacks to the CBL/SAT button. "VIDEO 1", "VIDEO 2": Assign a desired VIDEO IN jack to the CBL/SAT button.
GAME	COMPONENT 2	"COMPONENT 1", "COMPONENT 2": Assign the COMPONENT VIDEO IN jacks to the GAME button. "VIDEO 1", "VIDEO 2": Assign a desired VIDEO IN jack to the GAME button.
STRM BOX	VIDEO 2	"COMPONENT 1", "COMPONENT 2": Assign the COMPONENT VIDEO IN jacks to the STRM BOX button. "VIDEO 1", "VIDEO 2": Assign a desired VIDEO IN jack to the STRM BOX button.

Setting Item	Default Value	Setting Details
PC	---	"COMPONENT 1", "COMPONENT 2": Assign the COMPONENT VIDEO IN jacks to the PC button. "VIDEO 1" to "VIDEO 2": Assign a desired VIDEO IN jack to the PC button.
CD	---	"COMPONENT 1", "COMPONENT 2": Assign the COMPONENT VIDEO IN jacks to the CD button. "VIDEO 1", "VIDEO 2": Assign a desired VIDEO IN jack to the CD button.
TV	---	"COMPONENT 1", "COMPONENT 2": Assign the COMPONENT VIDEO IN jacks to the TV button. "VIDEO 1", "VIDEO 2": Assign a desired VIDEO IN jack to the TV button.
PHONO	---	"COMPONENT 1", "COMPONENT 2": Assign the COMPONENT VIDEO IN jacks to the PHONO button. "VIDEO 1", "VIDEO 2": Assign a desired VIDEO IN jack to the PHONO button.

■ 4. Digital Audio Input

You can change input assignment between the input selectors and DIGITAL IN COAXIAL/OPTICAL jacks. If you do not assign a jack, select "---".

Setting Item	Default Value	Setting Details
BD/DVD	COAXIAL	"COAXIAL", "OPTICAL 1", "OPTICAL 2": Assign a desired DIGITAL IN jack to the BD/DVD button.
CBL/SAT	---	"COAXIAL", "OPTICAL 1", "OPTICAL 2": Assign a desired DIGITAL IN jack to the CBL/SAT button.
GAME	---	"COAXIAL", "OPTICAL 1", "OPTICAL 2": Assign a desired DIGITAL IN jack to the GAME button.
STRM BOX	---	"COAXIAL", "OPTICAL 1", "OPTICAL 2": Assign a desired DIGITAL IN jack to the STRM BOX button.
PC	---	"COAXIAL", "OPTICAL 1", "OPTICAL 2": Assign a desired DIGITAL IN jack to the PC button.
CD	OPTICAL 1	"COAXIAL", "OPTICAL 1", "OPTICAL 2": Assign a desired DIGITAL IN jack to the CD button.

Setting Item	Default Value	Setting Details
TV	OPTICAL 2	"COAXIAL", "OPTICAL 1", "OPTICAL 2": Assign a desired DIGITAL IN jack to the TV button.
PHONO	---	"COAXIAL", "OPTICAL 1", "OPTICAL 2": Assign a desired DIGITAL IN jack to the PHONO button.

- Supported sampling rates for PCM signals (stereo, mono) from a digital input are 32kHz, 44.1kHz, 48kHz, 88.2kHz, 96kHz/16bit, 20bit, and 24bit.

■ 5. Analog Audio Input

You can change input assignment between the input selectors and AUDIO IN jacks. If you do not assign a jack, select "---".

Setting Item	Default Value	Setting Details
BD/DVD	AUDIO 1	"AUDIO 1" to "AUDIO 6": Assign a desired AUDIO IN jack to the BD/DVD button.
CBL/SAT	AUDIO 2	"AUDIO 1" to "AUDIO 6": Assign a desired AUDIO IN jack to the CBL/SAT button.
GAME	AUDIO 3	"AUDIO 1" to "AUDIO 6": Assign a desired AUDIO IN jack to the GAME button.
STRM BOX	AUDIO 4	"AUDIO 1" to "AUDIO 6": Assign a desired AUDIO IN jack to the STRM BOX button.
PC	---	"AUDIO 1" to "AUDIO 6": Assign a desired AUDIO IN jack to the PC button.
CD	AUDIO 5	"AUDIO 1" to "AUDIO 6": Assign a desired AUDIO IN jack to the CD button.
TV	AUDIO 6	"AUDIO 1" to "AUDIO 6": Assign a desired AUDIO IN jack to the TV button.
PHONO	PHONO	The setting cannot be changed.

2. Speaker

You can make changes to the connection environment of the speakers and change the volume level. Settings are automatically configured if you use AccuEQ Room Calibration. This setting cannot be selected if headphones are connected or audio is output from the speakers of the TV.

■ 1. Configuration

Setting Item	Default Value	Setting Details
Speaker Channels	7.1 ch	Select "2.1 ch", "3.1 ch", "4.1 ch", "5.1 ch", "6.1 ch", "7.1 ch", "2.1.2 ch", "3.1.2 ch", "4.1.2 ch", or "5.1.2 ch" to suit the number of speaker channels connected.
Subwoofer	Yes	Set whether a subwoofer is connected or not. "Yes": When subwoofer is connected "No": When subwoofer is not connected
Height Speaker	Top Middle	Set the speaker type if height speakers are connected to the SURROUND BACK or HEIGHT terminals. Select "Front High", "Top Front", "Top Middle", "Top Rear", "Rear High", "Dolby Speaker (Front)", or "Dolby Speaker (Surr)" according to the type and layout of the connected speakers. <ul style="list-style-type: none"> If an item cannot be selected even though connection is correct, check that the settings in "Speaker Channels" matches the number of connected channels.
Zone Speaker	No	Set the connection of speakers to Zone 2 speaker terminals. "Zone 2": When speakers are connected to Zone 2 speaker terminals "No": When speakers are not connected to Zone 2 speaker terminals

Setting Item	Default Value	Setting Details
Bi-Amp	No	Set whether the front speakers are bi-amp connected. "No": When front speakers are not bi-amp connected "Yes": When front speakers are bi-amp connected <ul style="list-style-type: none"> This item will be fixed to "No" when the "Zone Speaker" setting is "Zone 2". This setting cannot be selected when surround back speakers or height speakers are installed.
Speaker Impedance	6ohms	Set the impedance (Ω) of the connected speakers. "4ohms": When any of the connected speakers have 4 Ω or more to less than 6 Ω impedance "6ohms": When the connected speakers all have 6 Ω or more impedance. <ul style="list-style-type: none"> For impedance, check the indications on the back of the speakers or their instruction manual.

■ 2. Crossover

Setting Item	Default Value	Setting Details
Front	100Hz	Select the crossover frequency from "40Hz" to "200Hz" to start outputting frequencies for each channel. "Full Band": Full band will be output. <ul style="list-style-type: none"> If "Configuration" - "Subwoofer" is set to "No", "Front" will be fixed to "Full Band" and the low pitched range of the other channels will be output from the front speakers. Refer to the instruction manual of your speakers to make the setting.
Center	100Hz	Select the crossover frequency from "40Hz" to "200Hz" to start outputting frequencies for each channel. "Full Band": Full band will be output. <ul style="list-style-type: none"> "Full Band" can be selected only when "Front" is set to "Full Band". If an item cannot be selected even though connection is correct, check that the settings in "Configuration" - "Speaker Channels" matches the number of connected channels.
Height	100Hz	Select the crossover frequency from "40Hz" to "200Hz" to start outputting frequencies for each channel. "Full Band": Full band will be output. <ul style="list-style-type: none"> "Full Band" can be selected only when "Front" is set to "Full Band". If an item cannot be selected even though connection is correct, check that the settings in "Configuration" - "Speaker Channels" matches the number of connected channels.

Setting Item	Default Value	Setting Details
Surround	100Hz	Select the crossover frequency from "40Hz" to "200Hz" to start outputting frequencies for each channel. "Full Band": Full band will be output. <ul style="list-style-type: none"> "Full Band" can be selected only when "Front" is set to "Full Band". If an item cannot be selected even though connection is correct, check that the settings in "Configuration" - "Speaker Channels" matches the number of connected channels.
Surround Back	100Hz	Select the crossover frequency from "40Hz" to "200Hz" to start outputting frequencies for each channel. "Full Band": Full band will be output. <ul style="list-style-type: none"> "Full Band" can be selected only when "Surround" is set to "Full Band". If an item cannot be selected even though connection is correct, check that the settings in "Configuration" - "Speaker Channels" matches the number of connected channels.
LPF of LFE	120Hz	Set the low-pass filter for LFE (low-frequency effect) signals in order to pass lower frequency signals than the set value and thus cancel unwanted noises. The low-pass filter will be effective only on sources with LFE channel. The value from "80Hz" to "120Hz" can be set. "Off": When this function is not to be used
Double Bass	On	This can be selected only when "Configuration" - "Subwoofer" is set to "Yes" and "Front" is set to "Full Band". Boost bass output by feeding bass sounds from the front left and right, and center speakers to the subwoofer. "On": Bass output will be boosted "Off": Bass output will not be boosted <ul style="list-style-type: none"> The setting will not automatically be configured even if you performed AccuEQ Room Calibration.

■ **3. Distance**

Set the distance from each speaker to the listening position.

feet, you can set between 0.1 ft and 30.0 ft in increments of 0.1ft. When the unit is set as meters, you can set between 0.03 m and 9.00 m in increments of 0.03 m.

Setting Item	Default Value	Setting Details
Front Left	12.0ft/3.60m	Specify the distance between each speaker and the listening position.
Center	12.0ft/3.60m	Specify the distance between each speaker and the listening position.
Front Right	12.0ft/3.60m	Specify the distance between each speaker and the listening position.
Height Left	9.0ft/2.70m	Specify the distance between each speaker and the listening position. <ul style="list-style-type: none"> The setting cannot be changed if "Zone 2" is set in "Configuration" - "Zone Speaker" and Zone 2 is on.
Height Right	9.0ft/2.70m	Specify the distance between each speaker and the listening position. <ul style="list-style-type: none"> The setting cannot be changed if "Zone 2" is set in "Configuration" - "Zone Speaker" and Zone 2 is on.
Surround Right	7.0ft/2.10m	Specify the distance between each speaker and the listening position.
Surr Back Right	7.0ft/2.10m	Specify the distance between each speaker and the listening position. <ul style="list-style-type: none"> The setting cannot be changed if "Zone 2" is set in "Configuration" - "Zone Speaker" and Zone 2 is on.
Surr Back Left	7.0ft/2.10m	Specify the distance between each speaker and the listening position. <ul style="list-style-type: none"> The setting cannot be changed if "Zone 2" is set in "Configuration" - "Zone Speaker" and Zone 2 is on.
Surround Left	7.0ft/2.10m	Specify the distance between each speaker and the listening position.
Subwoofer	12.0ft/3.60m	Specify the distance between each speaker and the listening position.

- Distance units can be switched by pressing MODE on the remote controller. When the unit is set as

■ 4. Level Calibration

Setting Item	Default Value	Setting Details
Front Left	0 dB	Select a value between "− 12 dB" and "+12 dB" (in 1 dB increments). A test tone will be output each time you change the value. Select the desired level.
Center	0 dB	Select a value between "− 12 dB" and "+12 dB" (in 1 dB increments). A test tone will be output each time you change the value. Select the desired level.
Front Right	0 dB	Select a value between "− 12 dB" and "+12 dB" (in 1 dB increments). A test tone will be output each time you change the value. Select the desired level.
Height Left	0 dB	Select a value between "− 12 dB" and "+12 dB" (in 1 dB increments). A test tone will be output each time you change the value. Select the desired level. <ul style="list-style-type: none"> The setting cannot be changed if "Zone 2" is set in "Configuration" - "Zone Speaker" and Zone 2 is on.
Height Right	0 dB	Select a value between "− 12 dB" and "+12 dB" (in 1 dB increments). A test tone will be output each time you change the value. Select the desired level. <ul style="list-style-type: none"> The setting cannot be changed if "Zone 2" is set in "Configuration" - "Zone Speaker" and Zone 2 is on.
Surround Right	0 dB	Select a value between "− 12 dB" and "+12 dB" (in 1 dB increments). A test tone will be output each time you change the value. Select the desired level.

Setting Item	Default Value	Setting Details
Surr Back Right	0 dB	Select a value between "− 12 dB" and "+12 dB" (in 1 dB increments). A test tone will be output each time you change the value. Select the desired level. <ul style="list-style-type: none"> The setting cannot be changed if "Zone 2" is set in "Configuration" - "Zone Speaker" and Zone 2 is on.
Surr Back Left	0 dB	Select a value between "− 12 dB" and "+12 dB" (in 1 dB increments). A test tone will be output each time you change the value. Select the desired level. <ul style="list-style-type: none"> The setting cannot be changed if "Zone 2" is set in "Configuration" - "Zone Speaker" and Zone 2 is on.
Surround Left	0 dB	Select a value between "− 12 dB" and "+12 dB" (in 1 dB increments). A test tone will be output each time you change the value. Select the desired level.
Subwoofer	0 dB	Select a value between "− 15 dB" and "+12 dB" (in 1 dB increments). A test tone will be output each time you change the value. Select the desired level.

■ 5. Dolby Enabled Speaker

Setting Item	Default Value	Setting Details
Dolby Enabled Speaker to Ceiling	6.0 ft/1.80 m	Set the distance between the Dolby Enabled Speaker and the ceiling. Select between "0.1 ft/0.03 m" to "15.0 ft/4.50 m" (0.1 ft/0.03 m units). <ul style="list-style-type: none"> The unit of distance (ft/m) shown is the unit selected for use in "Distance".
AccuReflex	Off	You can enhance the reflection effect of Dolby Enabled Speakers from the ceiling. "Off": When this function is not to be used "On": When this function is to be used

- This setting can be selected when "Configuration" - "Height Speaker" is set to "Dolby Speaker".

■ 6. Equalizer Settings

You can adjust the output volume of the range of each connected speaker. You can adjust the volume of the different sound ranges for each of the speakers. You can set three different equalizers in Preset 1 to 3. You can select up to five bands for the Subwoofer and nine bands for all other speakers.

- The result may not be as expected depending on the input source and listening mode setting.

Setting Item	Default Value	Setting Details
Front	0 dB	After selecting the speaker frequency from between "25 Hz" and "16 kHz" with the cursors ◀/▶, adjust the volume of that frequency between "-6 dB" and "+6 dB" with ▲/▼.
Center	0 dB	After selecting the speaker frequency from between "25 Hz" and "16 kHz" with the cursors ◀/▶, adjust the volume of that frequency between "-6 dB" and "+6 dB" with ▲/▼.
Height	0 dB	After selecting the speaker frequency from between "25 Hz" and "16 kHz" with the cursors ◀/▶, adjust the volume of that frequency between "-6 dB" and "+6 dB" with ▲/▼. <ul style="list-style-type: none"> • The setting cannot be changed if "Zone 2" is set in "Configuration" - "Zone Speaker" and Zone 2 is on.
Surround	0 dB	After selecting the speaker frequency from between "25 Hz" and "16 kHz" with the cursors ◀/▶, adjust the volume of that frequency between "-6 dB" and "+6 dB" with ▲/▼.
Surround Back	0 dB	After selecting the speaker frequency from between "25 Hz" and "16 kHz" with the cursors ◀/▶, adjust the volume of that frequency between "-6 dB" and "+6 dB" with ▲/▼. <ul style="list-style-type: none"> • The setting cannot be changed if "Zone 2" is set in "Configuration" - "Zone Speaker" and Zone 2 is on.
Subwoofer	0 dB	After selecting the speaker frequency from between "25 Hz" and "160 Hz" with the cursors ◀/▶, adjust the volume of that frequency between "-6 dB" and "+6 dB" with ▲/▼. <ul style="list-style-type: none"> • This cannot be selected if "No" is set in "Configuration" - "Subwoofer".

3. Audio Adjust

Make advanced settings such as those related to multiplex audio, settings for the LFE level, or those related to the volume of this unit.

■ 1. Multiplex/Mono

Setting Item	Default Value	Setting Details
Multiplex Input Channel	Main	Set the audio channel or language to be output when playing multiplex audio or multilingual TV broadcasts etc. "Main": Main channel only "Sub": Sub channel only "Main/Sub": Main and sub channels will be output at the same time. • If multiplex audio is being played, "1+1" will be displayed when  on the remote controller is pressed.
Mono Input Channel	Left + Right	Set the input channel to use for playing any 2 ch digital source such as Dolby Digital, or 2 ch analog/PCM source in the Mono listening mode. "Left": Left channel only "Right": Right channel only "Left + Right" : Left and right channels

■ 2. Dolby

Setting Item	Default Value	Setting Details
Loudness Management	On	When playing Dolby TrueHD, enable the dialog normalization function which keeps the volume of dialog at a certain level. Note that when this setting is Off, the Late Night function that allows you to enjoy surround at low volumes is fixed to off when playing Dolby Digital Plus/Dolby TrueHD. "On": When this function is to be used "Off": When this function is not to be used

■ 3. DTS

Setting Item	Default Value	Setting Details
DTS Auto Surround	On	When inputting DTS signals that include extended channel information, the optimum listening mode is automatically selected according to the extended information contained in the input signal and the speaker configuration of this unit when playing in the straight decoding listening mode. "On": Use this function "Off": Audio is played using the same amount of channels in the input signal according to the speaker configuration of this unit. • The ES Matrix and ES Discrete listening modes cannot be selected if this function is set to "Off".

■ 4. LFE Level

Set the low-frequency effect (LFE) level for Dolby Digital series, DTS series, Multichannel PCM, and DSD signals.

Setting Item	Default Value	Setting Details
LFE Level	0dB	Select the low-frequency effect (LFE) level of each type of signal from "0dB" to " $-\infty$ dB". If the low-frequency effect sound is too strong, select " -20 dB" or " $-\infty$ dB".

■ 5. Volume

Setting Item	Default Value	Setting Details
Mute Level	$-\infty$ dB	Set the volume lowered from the listening volume when muting is on. Select a value from " $-\infty$ dB", " -40 dB", and " -20 dB".
Maximum Volume	Off	Set the maximum value to avoid too high volume. Select a value from "Off", "50" to "99".

Power On Volume	Last	Set the volume level of when the power is turned on. Select a value from "Last" (Volume level before entering standby mode), "Min", "1" to "99" and "Max". <ul style="list-style-type: none"> You cannot set a higher value than that of "Maximum Volume".
Headphone Level	0 dB	Adjust the output level of the headphones. Select a value between "-12 dB" and "+12 dB".

4. Source

Make settings for input sources, such as volume difference adjustments for each input selector for the connected equipment.

■ 1. IntelliVolume

Adjust the volume level difference between the devices connected to the unit. Select the input selector to configure.

Setting Item	Default Value	Setting Details
IntelliVolume	0 dB	Select a value between "-12 dB" and "+12 dB". Set a negative value if the volume of the target device is larger than the others and a positive value if smaller. To check the audio, start playback of the connected device. <ul style="list-style-type: none"> This function is not effective in Zone 2.

■ 2. Name Edit

Set an easy name to each input. The set name will be shown on the main unit display. Select the input selector to configure.

Setting Item	Default Value	Setting Details
Name Edit	Input name	<ol style="list-style-type: none"> Select a character or symbol with the cursors and press ENTER. Repeat it to input 10 or less characters. <ul style="list-style-type: none"> "A/a": Switches between upper and lower cases. (Pressing MODE on the remote controller also toggles between upper and lower cases) "←" "→": Moves the cursor to the arrow direction. "⊞": Removes a character on the left of the cursor. "␣": Enters a space. <ul style="list-style-type: none"> Pressing CLEAR on the remote controller will remove all the input characters. After inputting, select "OK" with the cursors and press ENTER. The input name will be saved.

- To name a preset radio station, press TUNER on the remote controller, select AM/FM and select the preset number.
- This cannot be set if the "NET" or "BLUETOOTH" input is selected.

■ Audio Select

Select the priority for input selection when multiple audio sources are connected to one input selector, such as connections to both the "BD/DVD" HDMI IN jack and the "BD/DVD" AUDIO IN jack. The setting can be separately set to each input selector button. Select the input selector to configure. Note that there are some default values you cannot change.

Setting Item	Default Value	Setting Details
Audio Select	BD/DVD: HDMI CBL/SAT: HDMI GAME: HDMI STRM BOX: HDMI PC: HDMI AUX: Analog CD: OPTICAL PHONO: Analog TV: OPTICAL	"ARC": When giving priority to input signal from ARC compatible TV. <ul style="list-style-type: none"> • The setting can be selected only when "5. Hardware" - "HDMI" - "Audio Return Channel" is set to "Auto" and also the "TV" input is selected. "HDMI": When giving priority to input signal from HDMI IN jacks <ul style="list-style-type: none"> • The setting can be selected only when the input is assigned to the HDMI jack in the "1. Input/Output Assign" - "HDMI Input" setting. "COAXIAL": When giving priority to input signal from DIGITAL IN COAXIAL jacks <ul style="list-style-type: none"> • The setting can be selected only when the input is assigned to the COAXIAL jack in the "1. Input/Output Assign" - "Digital Audio Input" setting. "OPTICAL": When giving priority to input signal from DIGITAL IN OPTICAL jacks <ul style="list-style-type: none"> • The setting can be selected only when the input is assigned to the OPTICAL jack in the "1. Input/Output Assign" - "Digital Audio Input" setting. "Analog": To always output analog audio independently of the input signal <ul style="list-style-type: none"> • The setting can be selected only when the input is assigned to the AUDIO IN jack in the "1. Input/Output Assign" - "Analog Audio Input" setting.

Setting Item	Default Value	Setting Details
PCM Fixed Mode	Off	Select whether to fix input signals to PCM (except multi-channel PCM) when you have selected "HDMI", "COAXIAL", or "OPTICAL" in the "Audio Select" setting. Set this item to "On" if noise is produced or truncation occurs at the beginning of a track when playing PCM sources. Select "Off" normally. <ul style="list-style-type: none"> • Changing "Audio Select" changes the setting to "Off".

- The setting cannot be changed when "TUNER", "NET", or "BLUETOOTH" input is selected.

■ Video Select

When "TUNER", "NET", or "BLUETOOTH" input is selected, you can set the input from which video is displayed on the TV.

Setting Item	Default Value	Setting Details
Video Select	Last	"Last": Select the video input played immediately prior. "BD/DVD", "CBL/SAT", "GAME", "STRM BOX", "PC", "CD", "TV", "PHONO": Play the video from the selected input. <ul style="list-style-type: none"> • This setting is effective for an input selector which is assigned in "1. Input/Output Assign" - "HDMI Input" and "Video Input".

5. Hardware

Make settings related to the HDMI CEC, HDMI Standby Through, ARC features, settings related to network features, and settings related to power management of the unit, such as Auto Standby and Network Standby.

■ 1. HDMI

Setting Item	Default Value	Setting Details
HDMI CEC	Off	<p>Setting to "On" enables the input selection link and other link functions with HDMI connected CEC compliant device.</p> <p>"On": When this function is to be used "Off": When this function is not to be used When changing this setting, turn off and then on again the power of all connected components.</p> <ul style="list-style-type: none"> Depending on the TV set, a link may need to be configured on the TV. Setting to "On" and closing the on-screen menu displays the name of the CEC-compatible components and "CEC On" on the display. Power consumption in standby mode may increase if "On" is set. (Depending on the TV status, the unit will enter the normal standby mode.) If you operate the MASTER VOLUME dial on the main unit when this setting is "On" and audio is output from the TV speakers, audio will be output also from the speakers connected to the unit. If you want to output from only either of them, change the unit or TV settings, or reduce the volume of the unit. If abnormal operation occurs when you set the setting to "On", set it to "Off". When connecting a non-CEC compatible component, or when you are not sure whether it is compatible, set the setting to "Off".

Setting Item	Default Value	Setting Details
HDMI Standby Through	Off	<p>When this is set to anything other than "Off", you can play the video and audio of an HDMI connected player on the TV even if the unit is in standby mode. Only "Auto" and "Auto(Eco)" can be selected if "HDMI CEC" is set to "On". If you select anything else, set "HDMI CEC" to "Off".</p> <ul style="list-style-type: none"> Power consumption in standby mode increases if set to anything other than "Off". <p>"BD/DVD", "CBL/SAT", "GAME", "STRM BOX", "PC", "CD", "TV", "PHONO": For example, if you select "BD/DVD", you can play the equipment connected to the "BD/DVD" jack on the TV even if the unit is in standby mode. Select this setting if you have decided which player to use with this function.</p> <p>"Last": You can play the video and audio of the input selected immediately prior to the unit being switched to standby on the TV. When "Last" is selected, you can switch the input of the unit even in the standby mode with the remote controller or the Onkyo Remote app.</p> <p>"Auto", "Auto (Eco)": Select one of these settings when you have connected equipment that conforms to the CEC standard. You can play the video and audio of the input selected on the TV, irrespective of what input was selected immediately prior to the unit being switched to standby, using the CEC link function.</p> <ul style="list-style-type: none"> To play players on the TV that do not conform to the CEC standard, you will need to turn the unit on and switch to the relevant input. When using TV that complies with the CEC standard, you can reduce the power consumption in standby mode by selecting "Auto (Eco)".

Setting Item	Default Value	Setting Details
Audio TV Out	Off	<p>You can enjoy audio through the speakers of the TV while this unit is on.</p> <p>"On": When this function is to be used "Off": When this function is not to be used</p> <ul style="list-style-type: none"> The setting is fixed to "Auto" if "HDMI CEC" is set to "On". If you change this setting, set "HDMI CEC" to "Off". Listening mode cannot be changed while "Audio TV Out" is set to "On" and audio is being output through the speakers of the TV. Depending on your TV set or input signal of the component, audio may not output through the speakers of the TV even if this setting is set to "On". In such case, audio is output from the speakers of the unit. If you operate the MASTER VOLUME dial on this unit when audio that is being input through this unit for output from the TV speakers, audio is output from this unit. If you do not want to output audio from the unit, change the unit or TV settings, or reduce the volume of the unit.
Audio Return Channel	Auto (*)	<p>You can enjoy sound of the HDMI connected ARC compatible TV through the speakers connected to the unit.</p> <p>* To use this function, set "HDMI CEC" to "On" in advance.</p> <p>"Auto": When enjoying the TV sound through the speakers connected to the unit "Off": When not using the ARC function</p>
Auto LipSync	On	<p>This setting automatically corrects any desynchronization between the video and audio signals based on data from the HDMI LipSync compatible TV.</p> <p>"On": Automatic correction will be enabled "Off": Automatic correction will be disabled</p>

■ 2. Network

- When LAN is configured with a DHCP, set "DHCP" to "Enable" to configure the setting automatically. ("Enable" is set by default) To assign fixed IP addresses to each components, you must set "DHCP" to "Disable" and assign an address to this unit in "IP Address" as well as set information related to your LAN, such as Subnet Mask and Gateway.

Setting Item	Default Value	Setting Details
Wi-Fi	Off(Wired)	<p>Connect the unit to network via wireless LAN router.</p> <p>"On": Wireless LAN connection "Off(Wired)": Wired LAN connection</p>
Wi-Fi Setup	-	You can configure wireless LAN settings by pressing ENTER when "Start" is displayed.
Wi-Fi Status	-	<p>The information of the connected access point will be displayed.</p> <p>"SSID": SSID of the connected access point. "Signal": Signal strength of the connected access point. "Status": Status of the connected access point.</p>
MAC Address	-	<p>This is the MAC address of this unit.</p> <p>This value is specific to the component and cannot be changed.</p>
DHCP	Enable	<p>"Enable": Auto configuration by DHCP "Disable": Manual configuration without DHCP</p> <ul style="list-style-type: none"> If selecting "Disable", you must set "IP Address", "Subnet Mask", "Gateway", and "DNS Server" manually.
IP Address	0.0.0.0	Displays/Sets the IP address.
Subnet Mask	0.0.0.0	Displays/Sets the subnet mask.
Gateway	0.0.0.0	Displays/Sets the gateway.
DNS Server	0.0.0.0	Displays/Sets the primary DNS server.
Proxy URL	-	Displays/Sets the proxy server URL.
Proxy Port	8080	Displays/Sets the proxy server port number when you enter "Proxy URL".

Setting Item	Default Value	Setting Details
Friendly Name	Onkyo TX-NR575 XXXXXX	<p>Change the device name for this unit which is shown on other devices connected to the network to an easily recognized name.</p> <ol style="list-style-type: none"> Press ENTER to display the Edit screen. Select a character or symbol with the cursors and press ENTER. Repeat it to input 31 or less characters. "A/a": Switches between upper and lower cases. (Pressing MODE on the remote controller also toggles between upper and lower cases.) "←" "→": Moves the cursor to the arrow direction. "⌫": Removes a character on the left of the cursor. "␣": Enters a space. <ul style="list-style-type: none"> Pressing CLEAR on the remote controller will remove all the input characters. After inputting, select "OK" with the cursors and press ENTER. The input name will be saved.

Setting Item	Default Value	Setting Details
AirPlay Password		<p>You can set a password of up to 31 characters so that only registered users can use AirPlay®.</p> <ol style="list-style-type: none"> Press ENTER to display the Edit screen. Select a character or symbol with the cursors and press ENTER. Repeat it to input 31 or less characters. "A/a": Switches between upper and lower cases. (Pressing MODE on the remote controller also toggles between upper and lower cases.) "←" "→": Moves the cursor to the arrow direction. "⌫": Removes a character on the left of the cursor. "␣": Enters a space. <ul style="list-style-type: none"> To select whether to mask the password with "*" or display it in plain text, press MEMORY on the remote controller. Pressing CLEAR on the remote controller will remove all the input characters. After inputting, select "OK" with the cursors and press ENTER. The input password will be saved.
Usage Data	No	<p>As a means of improving the quality of our products and services, we may collect information about your usage over the network. Select "Yes" if you agree to our collecting this information. Select "No" if you do not want us to collect this information.</p> <ul style="list-style-type: none"> You can set this after confirming the Privacy Policy. When you select "Usage Data" and press ENTER, the Privacy Policy is displayed. (The same screen is displayed once also when setting up the network connection.) If you agree to the collection of the information, this setting also becomes "Yes". Note that if you agree to the Privacy Policy but select "No" for this setting, the information will not be collected.
Network Check	-	<p>You can check the network connection. Press ENTER when "Start" is displayed.</p>

- Wait for a while if "Network" cannot be selected. It will appear when the network feature is started.

■ 3. Bluetooth

Setting Item	Default Value	Setting Details
Bluetooth	On	Select whether or not to use the BLUETOOTH function. "On": Enables connection with a BLUETOOTH wireless technology enabled device by using the BLUETOOTH function. Select "On" also when making various BLUETOOTH settings. "Off": When not using the BLUETOOTH function
Auto Input Change	On	The input of the unit will automatically be switched to "BLUETOOTH" when connection is made from a BLUETOOTH wireless technology enabled device to the unit. "On": The input will automatically become "BLUETOOTH" when a BLUETOOTH wireless technology enabled device is connected. "Off": The function is disabled. <ul style="list-style-type: none"> • If the input is not switched automatically, set to "Off" and change the input manually.
Auto Reconnect	On	This function automatically reconnects to the BLUETOOTH wireless technology enabled device connected last when you change the input to "BLUETOOTH". "On": When this function is to be used "Off": When this function is not to be used <ul style="list-style-type: none"> • This may not work with some BLUETOOTH wireless technology enabled devices.

Setting Item	Default Value	Setting Details
Pairing Information	-	You can initialize the pairing information saved on this unit. Pressing ENTER when "Clear" is displayed initializes the pairing information stored in this unit. <ul style="list-style-type: none"> • This function does not initialize the pairing information on the BLUETOOTH wireless technology enabled device. When pairing the unit again with the device, be sure to clear the pairing information on the BLUETOOTH wireless technology enabled device in advance. For information on how to clear the pairing information, refer to the BLUETOOTH wireless technology enabled device's instruction manual.
Device	-	Displays the name of the BLUETOOTH wireless technology enabled device connected to the unit. <ul style="list-style-type: none"> • The name is not displayed when "Status" is "Ready" and "Pairing".
Status	-	Displays the status of the BLUETOOTH wireless technology enabled device connected to the unit. "Ready": Not paired "Pairing": Paired "Connected": Successfully connected

- Wait for a while if "Bluetooth" cannot be selected. It will appear when the BLUETOOTH function is started up.

■ 4. Power Management

Setting Item	Default Value	Setting Details
Sleep Timer	Off	Allows the unit to enter standby automatically when the specified time elapses. Select a value from "30 minutes", "60 minutes", and "90 minutes". "Off": Does not turn the unit to standby automatically.
Auto Standby	Off	This setting places the unit on standby automatically after 20 minutes of inactivity without any video or audio input. (When "USB Power Out at Standby" or "Network Standby" is on, this becomes the HYBRID STANDBY mode which reduces the increase in power consumption to a minimum.) "On": The unit will automatically enter standby mode ("AUTO STBY" will light). "Off": The unit will not automatically enter standby mode. <ul style="list-style-type: none"> "Auto Standby" is displayed on the display and TV screen 30 seconds before the Auto Standby comes on. "Auto Standby" does not work when Zone 2 is active.
Auto Standby in HDMI Standby Through	Off	Enable or disable "Auto Standby" while "HDMI Standby Through" is on. "On": The setting will be enabled. "Off": The setting will be disabled. <ul style="list-style-type: none"> This setting cannot be set to "On" if "Auto Standby" and "HDMI Standby Through" are set to "Off".
USB Power Out at Standby	Off	Devices connected to the USB port are supplied with electricity even when this unit is in standby mode when this function is "On". <ul style="list-style-type: none"> When using this feature, power consumption increases even when the unit is on standby, however, the increase in power consumption is kept to a minimum by automatically entering the HYBRID STANDBY mode, where only essential circuits are operating.

Setting Item	Default Value	Setting Details
Network Standby	On	When this feature is turned "On", you can turn on the power of the unit via the network using an application such as Onkyo Remote that can control this unit. <ul style="list-style-type: none"> When "Network Standby" is used, the power consumption increases even when the unit is on standby. However, the increase in power consumption is kept to a minimum by automatically entering the HYBRID STANDBY mode, where only the essential circuit is operating. When the connection to the network is lost, "Network Standby" is disabled to reduce power consumption. Use the power button on the remote controller or main unit to turn the unit on if this happens.
Bluetooth Wakeup	Off	This function wakes up the unit on standby by connecting a BLUETOOTH wireless technology enabled device. "On": When this function is to be used "Off": When this function is not to be used <ul style="list-style-type: none"> Setting to "On" increases the power consumption even when the unit is on standby. However, the increase in power consumption is kept to a minimum by automatically entering the HYBRID STANDBY mode, where only the essential circuit is operating. This setting is fixed to "Off" if "Bluetooth" - "Auto Input Change" is set to "Off".

- Wait for a while if "Network Standby" and "Bluetooth Wakeup" cannot be selected. It will appear when the network feature is started.

6. Multi Zone

Make settings related to Multi-zone Connection, such as the volume for the separate room.

■ 1. Zone 2

Setting Item	Default Value	Setting Details
Maximum Volume	Off	Set the maximum value for Zone 2 to avoid too high volume. Select a value from "Off", "50" to "99".
Power On Volume	Last	Set the Zone 2 volume level of when this unit is turned on. Select a value from "Last" (Volume level when the unit was turned off), "Min", "1" to "99" and "Max". <ul style="list-style-type: none"> You cannot set a higher value than that of "Maximum Volume".

■ 2. Remote Play Zone

Setting Item	Default Value	Setting Details
Remote Play Zone	Auto	When playing using AirPlay or Spotify Connect, or when using the Music Server feature to play remotely from your PC, you can set whether to play in the main room (where this unit is) or in a separate room (ZONE 2). "Auto": When the main room input selector is NET, music is played in the main room. When the separate room input selector is NET and the main room is other than NET, then the music is played in the separate room. "Main", "Zone2": Select when limiting the play zone to a particular room. For example, when playing only in the separate room, select "Zone 2". <ul style="list-style-type: none"> This feature may not work if something is already being played with the same network feature.

7. Miscellaneous

Change the frequency step for the tuner, update the firmware, and perform Initial Setup, etc.

■ 1. Tuner

Setting Item	Default Value	Setting Details
AM / FM Frequency Step	10 kHz / 0.2 MHz	Select a frequency step depending on your area of residence. Select "10 kHz/0.2 MHz" or "9 kHz/0.05 MHz". <ul style="list-style-type: none"> When this setting is changed, all radio presets are deleted.

■ 2. Remote ID

Setting Item	Default Value	Setting Details
Remote ID	1	Select an ID for the unit's remote controller from "1", "2", and "3" to prevent interference between the unit and other ONKYO components that are installed in the same room. After changing the ID on the main unit, change the ID on the remote controller accordingly with the following procedure. While holding down MODE, press the following buttons for about 3 seconds. <ul style="list-style-type: none"> To change the remote controller ID to "1": ◀◀ (The remote indicator flashes once.) To change the remote controller ID to "2": ▶▶ (The remote indicator flashes twice.) To change the remote controller ID to "3": ▶▶▶ (The remote indicator flashes three times.)

■ 3. Firmware Update

Setting Item	Default Value	Setting Details
Update Notice	Enable	Availability of a firmware update will be notified via network. "Enable": Notify updates "Disable": Disable notifications
Version	-	The current firmware version will be displayed.
Update via NET	-	Press ENTER to select when you want to update the firmware via network. <ul style="list-style-type: none"> You will not be able to select this setting if you do not have Internet access or there is nothing to update.
Update via USB	-	Press ENTER to select when you want to update the firmware via USB. <ul style="list-style-type: none"> You will not be able to select this setting if a USB storage device is not connected or there is nothing to update in the USB storage device.

- Wait for a while if "Firmware Update" cannot be selected. It will appear when the network feature is started.

■ 4. Initial Setup

You can make the initial setup from the setup menu.

- Wait for a while if "Initial Setup" cannot be selected. It will appear when the network feature is started.

■ 5. Lock

Setting Item	Default Value	Setting Details
Setup Parameter	Unlocked	Lock the Setup menu to protect the settings. "Locked": The menu is locked. "Unlocked": The menu is unlocked.

Quick Menu

You can quickly adjust settings you frequently use, such as tone adjustments, etc.

Operation:

You can make the settings on the TV screen while playing something. Press Q on the remote controller to display the Quick Menu.

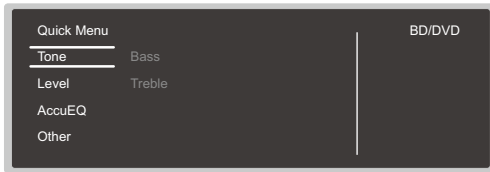

Select the item with the cursor ▲/▼ buttons of the remote controller and press ENTER to confirm your selection. Use the cursors to change the settings.

- To return to the previous screen, press ⏪.
- To exit the settings, press Q.

■ Tone

Bass:

Enhance or moderate the bass range of the front speakers.

Treble:

Enhance or moderate the treble range of the front speakers.

- It cannot be set if the listening mode is Direct.

■ Level

Center:

Adjust the speaker level of the center speaker while listening to some sound.

Subwoofer:

Adjust the speaker level of the subwoofer while listening to some sound.

- The adjustment you made will be reset to the previous status when you turn the unit to standby mode.

■ AccuEQ

AccuEQ Room Calibration:

Enable or disable the equalizer function that corrects for distortion caused by the acoustic environment of the room. If this is to be enabled, then normally you should select "On (All Ch)", and to disable just the front speakers you should select "On (ex. L/R)". The setting can be separately set to each input selector.

Equalizer:

Select "Preset 1" to "Preset 3" configured in "2. Speaker" - "Equalizer Settings" in the Setup menu. The same sound field setting is applied all ranges when set to "Off".

Cinema Filter:

Adjust the soundtrack that was processed to enhance its high pitch range, in order to make it suitable for home theater. This function can be used in the following listening modes: Dolby Digital, Dolby Digital Plus, Dolby Surround, Dolby TrueHD, Multichannel, DTS, DTS-ES, DTS 96/24, DTS-HD High Resolution Audio, DTS-HD Master Audio, DTS Neural:X, DTS Express and DSD.

- It cannot be set if the listening mode is Direct.

■ Other

A/V Sync:

If the video is behind the audio, you can delay the audio to offset the gap. Different settings can be set for each input selector.

- It cannot be set if the listening mode is Direct.

Music Optimizer:

Improve the quality of the compressed audio. Playback sound of lossy compressed files such as MP3 will be improved. The setting can be separately set to each input selector. The setting is effective in the signals of 48 kHz or

less. The setting is not effective in the bitstream signals.

- It cannot be set if the listening mode is Direct.

Late Night:

Make small sounds easily heard. It is useful when you need to reduce the volume while watching a movie late night. You can enjoy the effect only when playing Dolby series and DTS series input signals.

- The setting cannot be used in the following cases.
 - If "Loudness Management" is set to "Off" when playing Dolby Digital Plus or Dolby TrueHD
 - When the input signal is DTS:X and "Dialog Control" is other than 0 dB

Center Spread:

Adjust the width of the sound field of the front channel when playing in the Dolby Surround listening mode. To spread the width of the sound field to the left and right, set to "On". To concentrate sound in the center, set to "Off".

- Depending on the speaker settings, this becomes "Off".

Dialog Control:

You can increase the dialog portion of the audio in 1 dB steps up to 6 dB so that you can make dialog easier to hear over background noise.

- This cannot be set for content other than DTS:X.
- The effect may not be selectable with some content.

Web Setup

You can make the settings for network features for this unit in an internet browser on a PC, smartphone, etc.

1. Press  on the remote controller to display the Setup menu.
2. Select "5. Hardware" - "Network" with the cursors, then take a note of the IP address displayed in "IP Address".
3. Start the internet browser on your PC or smartphone and enter the IP address of the unit in the URL field.
4. Information for the unit (Web Setup screen) is displayed in the internet browser.



5. After changing the settings, select "Save" to save the settings.

Device Information

You can change the Friendly Name, set an AirPlay Password, etc.

Control4: Register this unit if you are using a Control4 system.

Firmware Update: Select the firmware update you have downloaded to your PC so you can update this unit.

Network Setting

Status: You can see information for the network such as

the MAC address and IP address for this unit.

Network Connection: You can select how to connect to the network. If you select "Wireless", select an access point from "Wi-Fi Setup" to connect.

DHCP: You can change DHCP settings. If you select "Off", set "IP Address", "Subnet Mask", "Gateway", and "DNS Server" manually.

Proxy: Display and set the URL for the proxy server.

Firmware Update

The updating function on this unit

This unit has functionality to update the firmware (the system software) over a network or by the USB port. This enables us to make improvements to a variety of operations and to add features.

- For the latest information on updates, visit our company's website. There is no need to update the firmware on this unit if there is no update available.
- Before updating, make sure that the speaker setup microphone is not connected.
- During an update, do not
 - Disconnect and reconnect any cable, USB storage device, speaker setup microphone or headphones, or perform any operation on the component such as turn off its power
 - Accessing this unit from a PC or smartphone using an application
- The update may take about 20 minutes to complete for either method: via network or via USB. Furthermore, existing settings are guaranteed regardless of the method used for update.

Note that when this unit is connected to a network, you may see notifications about firmware updates on the display. To execute updating, select "Update Now" with the cursor buttons of the remote controller and press ENTER. The unit automatically turns itself into standby mode after "Completed!" appears on the display, and updating will be complete.

Disclaimer: The program and accompanying online documentation are furnished to you for use at your own risk.

Our company will not be liable and you will have no remedy for damages for any claim of any kind whatsoever

concerning your use of the program or the accompanying online documentation, regardless of legal theory, and whether arising in tort or contract.

In no event will our company be liable to you or any third party for any special, indirect, incidental, or consequential damages of any kind, including, but not limited to, compensation, reimbursement or damages on account of the loss of present or prospective profits, loss of data, or for any other reason whatsoever.

Updating the Firmware via Network

Preparation:

- Check that the unit is turned on, and the connection to the Internet is secured.
 - Turn off the controller component (PC etc.) connected to the network.
 - Stop any playing Internet radio, USB storage device, or server content.
 - If the multi-zone function is active, turn it off.
 - If "HDMI CEC" is set to "On", set it to "Off".
 - Press  on the remote controller. Then, after selecting "5. Hardware" - "HDMI" and pressing ENTER, select "HDMI CEC" and select "Off".
- * The description may differ from the on-screen display but that will not change the way to operate or the function.

■ Update

1. Press  on the remote controller. The Setup menu is displayed on the TV screen.

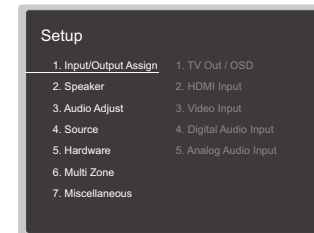

2. Select "7. Miscellaneous" - "Firmware Update" - "Update via NET" with the cursors in order, then press ENTER.

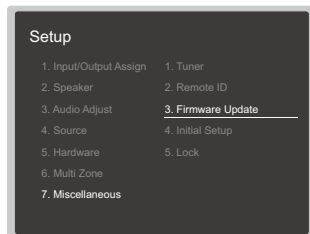

- If "Firmware Update" is grayed out and cannot be selected, wait for a while until it starts up.
 - You will not be able to select "Update via NET" if there is nothing to update.
3. Press ENTER with "Update" selected to start update.
 - During the update, the TV screen may go black depending on the updated program. In that case, check the progress on the display of the unit. The TV screen will remain black until the update is complete and the power is turned on again.
 - "Completed!" is displayed when the update is complete.
 4. Press **ON/STANDBY** on the main unit to turn the unit into standby mode. The process is completed and your firmware is updated to the latest version.
 - Do not use **ON/STANDBY** on the remote controller.

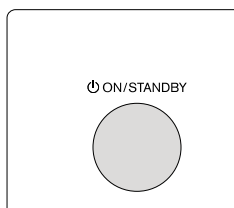

■ If an Error Message is Displayed

When an error occurs, "*-* * Error!" is displayed on the display of the unit. ("*" represents an alphanumeric character.) Check the following:

Error Code

- ***-01, *-10:**
Ethernet cable not found. Connect the Ethernet cable properly.
- ***-02, *-03, *-04, *-05, *-06, *-11, *-13, *-14, *-16, *-17, *-18, *-20, *-21:**
Internet connection error. Check the following:
 - The router is turned on
 - This unit and the router are connected via the network
 Try to disconnect and then connect again the power to the unit and router. This may solve the problem. If you are still unable to connect to the Internet, the DNS server or proxy server may be temporarily down. Check the service status with your ISP provider.
- **Others**
Disconnect then reconnect the AC power cord, then repeat from the beginning.

Updating via USB

Preparation:

- Prepare a 128MB or larger USB storage device. FAT16 or FAT32 file system format.
 - Media inserted in a USB card reader may not be used for this function.
 - USB storage devices with security function are not supported.
 - USB hubs and USB devices with hub function are not supported. Do not connect these devices to the unit.
- Delete any data stored on the USB storage device.
- Turn off the controller component (PC etc.) connected to the network.
- Stop any playing Internet radio, USB storage device, or server content.
- If the multi-zone function is active, turn it off.
- If "HDMI CEC" is set to "On", set it to "Off".
 - Press **Settings** on the remote controller. Then, after selecting "5. Hardware" - "HDMI" and pressing ENTER, select "HDMI CEC" and select "Off".
- * Some USB storage devices may take long to load, may not be loaded correctly, or may not be correctly fed depending on the device or their content.
- * Our company will not be liable whatsoever for any loss or damage of data, or storage failure arising from the use of the USB storage device with this unit. Thank you for your understanding.
- * The description may differ from the on-screen display but that will not change the way to operate or the function.

■ Update

1. Connect the USB storage device to your PC.
2. Download the firmware file from our company's website to your PC and unzip.
Firmware files are named in the following way:
ONKA VR*****_*****.zip
Unzip the file on your PC. The number of unzipped files and folders varies depending on the model.
3. Copy all unzipped files and folders to the root folder of the USB storage device.
 - Make sure to copy the unzipped files.

4. Connect the USB storage device to the USB port of the unit.
 - If you connect a USB hard disk drive to the USB port of the unit, we recommend that you use its AC adapter to power it.
 - If the USB storage device has been partitioned, each section will be treated as an independent device.
5. Press  on the remote controller. The Setup menu is displayed on the TV screen.

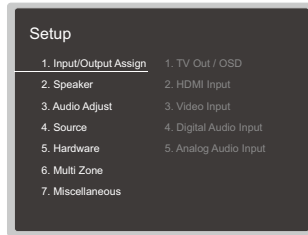

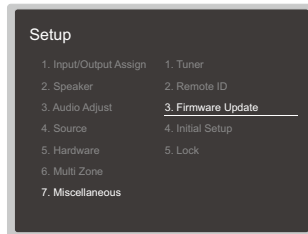

6. Select "7. Miscellaneous" - "Firmware Update" - "Update via USB" with the cursors in order, then press ENTER.



- If "Firmware Update" is grayed out and cannot be selected, wait for a while until it starts up.
 - You will not be able to select "Update via USB" if there is nothing to update.
7. Press ENTER with "Update" selected to start update.
 - During the update, the TV screen may go black depending on the updated program. In that case, check the progress on the display of the unit. The

TV screen will remain black until the update is complete and the power is turned on again.

- During the update, do not turn off, or disconnect then reconnect the USB storage device.
- "Completed!" is displayed when the update is complete.

8. Disconnect the USB storage device from the unit.
9. Press  ON/STANDBY on the main unit to turn the unit into standby mode. The process is completed and your firmware is updated to the latest version.
 - Do not use  on the remote controller.

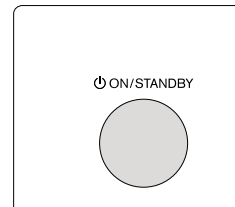

■ If an Error Message is Displayed

When an error occurs, "*-* * Error!" is displayed on the display of the unit. ("*" represents an alphanumeric character.) Check the following:

Error Code

- ***-01, *-10:**
USB storage device not found. Check whether the USB storage device or USB cable is correctly inserted to the USB port of the unit.
Connect the USB storage device to an external power source if it has its own power supply.
- ***-05, *-13, *-20, *-21:**
The firmware file is not present in the root folder of the USB storage device, or the firmware file is for another model. Retry from the download of the firmware file.
- **Others**
Disconnect then reconnect the AC power cord, then repeat from the beginning.

Selecting Listening Modes

Select the optimum listening mode for movies, TV, music, and games by repeatedly pressing the MOVIE/TV, MUSIC, and GAME buttons.

1. During play, press one of the following three buttons on the remote controller.

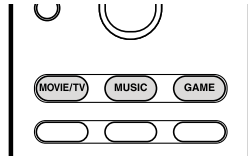

2. Press the selected button repeatedly to switch the modes displayed on the display of the unit.

Dolby D

For details on the effects of each of the listening modes see "Listening Mode Effects". For listening modes selectable for each of the audio formats in the input signals, refer to "Selectable Listening Modes".

Listening Mode Effects

In alphabetical order

■ AllCh Stereo

This mode is ideal for background music. Stereo sound is played through the surround speakers as well as the front speakers, creating a stereo image.

■ Direct

This listening mode can be selected for all input signals. Processing that affects sound quality is shut down so sound closer to the original is reproduced. Speakers play the sound field according to the number of channels in the input signal, so there would be output from only the front speakers for a two-channel signal, for example.

■ Dolby Atmos

This mode faithfully reproduces the sound design recorded in the Dolby Atmos audio format.

The Dolby Atmos audio format has been implemented in movie theaters equipped with the latest facilities and enables a revolutionary sound experience in home theaters. Unlike existing surround systems, Dolby Atmos doesn't rely on channels, but rather enables the accurate placement of sound objects that have independent motion in a three-dimensional space with even greater clarity. Dolby Atmos is an optional audio format on Blu-ray Discs and achieves a three-dimensional sound field by introducing a sound field above the listener.

- To enable transfer of this audio format, connect via HDMI cable and set audio output on the player to bitstream output.

■ Dolby D (Dolby Digital)

This mode faithfully reproduces the sound design recorded in the Dolby Digital audio format.

Dolby Digital is a multi-channel digital format developed by Dolby Laboratories, Inc. widely adopted for use in movie production. It is also a standard audio format on DVD-Video and Blu-ray Discs. It is possible to record a maximum of 5.1 channels on a DVD-Video or Blu-ray Disc; two front channels, a center channel, two surround channels, and the LFE channel dedicated to the bass region (sound elements for the subwoofer).

- To enable transfer of this audio format, connect via digital cable and set audio output on the player to bitstream output.

■ Dolby D+ (Dolby Digital Plus)

This mode faithfully reproduces the sound design recorded in the Dolby Digital Plus audio format.

The Dolby Digital Plus format is a revision based on Dolby Digital, increasing the number of channels and endeavoring to improve sound quality by giving more flexibility in data bit rates. Dolby Digital Plus is used as an optional audio format on Blu-ray Discs, based on 5.1ch, but with additional channels such as the surround back channel added for a maximum of 7.1ch.

- To enable transfer of this audio format, connect via HDMI cable and set audio output on the player to bitstream output.

■ Dolby Surround

This listening mode allows you to expand the playback signal to 5.1 channels or 7.1 channels to suit the connected speaker configuration when the input signal is 2 channels or 5.1 channels. Along with past speaker setups, this is also compatible with playback systems for Dolby Atmos that include Dolby speaker technology.

■ Dolby TrueHD

This mode faithfully reproduces the sound design recorded in the Dolby TrueHD audio format.

The Dolby TrueHD audio format is a reversible format expanded based on the lossless compression technology referred to as MLP, and it makes it possible to faithfully reproduce the master audio recorded in the studio. Dolby TrueHD is used as an optional audio format on Blu-ray

Discs, based on 5.1ch, but with additional channels such as the surround back channel added for a maximum of 7.1ch. 7.1ch is recorded at 96 kHz/24bit, and 5.1ch is recorded at 192 kHz/24bit.

- To enable transfer of this audio format, connect via HDMI cable and set audio output on the player to bitstream output.

■ DSD

Mode suitable for playing sources recorded in DSD.

- This unit supports DSD signals input through HDMI IN. However, depending on the connected player, better sound is possible when output from the PCM output of the player.
- This listening mode cannot be selected if the output setting on your Blu-ray Disc/DVD player is not set to DSD.

■ DTS

This mode faithfully reproduces the sound design recorded in the DTS audio format.

The DTS audio format is a multi-channel digital format developed by DTS, Inc. This format is an optional audio format on DVD-Video and a standard on Blu-ray Discs. It enables recording of 5.1 channels; two front channels, a center channel, two surround channels, and the LFE channel dedicated to the bass region (sound elements for the subwoofer). The content is recorded with a rich volume of data, with maximum sampling rate of 48 kHz at a resolution of 24 bits and a bit rate of 1.5 Mbps.

- To enable transfer of this audio format, connect via digital cable and set audio output on the player to bitstream output.

■ DTS 96/24

This mode faithfully reproduces the sound design recorded in the DTS 96/24 audio format.

The DTS 96/24 format is an optional audio format on DVD-Video and Blu-ray Discs. It enables recording of 5.1 channels; two front channels, a center channel, two surround channels, and the LFE channel dedicated to the bass region (sound elements for the subwoofer). Detailed

reproduction is achieved by recording the content at a sampling rate of 96 kHz at a resolution of 24 bits.

- To enable transfer of this audio format, connect via digital cable and set audio output on the player to bitstream output.

■ DTS Express

This mode faithfully reproduces the sound design recorded in the DTS Express audio format.

DTS Express is used as an optional audio format on Blu-ray Discs, based on 5.1ch, but with channels such as the surround back channel added for a maximum of 7.1ch. It also supports low bit rates.

- To enable transfer of this audio format, connect via HDMI cable and set audio output on the player to bitstream output.

■ DTS-HD HR (DTS-HD High Resolution Audio)

This mode faithfully reproduces the sound design recorded in the DTS-HD High Resolution Audio audio format.

DTS-HD High Resolution Audio is used as an optional audio format on Blu-ray Discs, based on 5.1ch, but with additional channels such as the surround back channel added for a maximum of 7.1ch. It can be recorded at a sampling rate of 96 kHz with a resolution of 24 bits.

- To enable transfer of this audio format, connect via HDMI cable and set audio output on the player to bitstream output.

■ DTS-HD MSTR (DTS-HD Master Audio)

This mode faithfully reproduces the sound design recorded in the DTS-HD Master Audio audio format.

DTS-HD Master Audio is used as an optional audio format on Blu-ray Discs, based on 5.1ch, but with additional channels such as the surround back channel added for a maximum of 7.1ch, recorded using lossless audio reproduction technology. 96 kHz/24bit is supported with 7.1ch, and 192 kHz/24bit is supported with 5.1ch.

- To enable transfer of this audio format, connect via HDMI cable and set audio output on the player to bitstream output.

■ DTS Neural:X

This listening mode allows you to expand the playback signal to 5.1 channels or 7.1 channels to suit the connected speaker configuration when the input signal is 2 channels or 5.1 channels.

■ DTS:X

This mode faithfully reproduces the sound design recorded in the DTS:X audio format.

The DTS:X audio format is a combination of the mixing methodology based on past channel based formats (5.1ch and 7.1ch) and object based dynamic audio mixing, and it is characterized by the precise positioning of sounds and the ability to express movement.

- To enable transfer of this audio format, connect via HDMI cable and set audio output on the player to bitstream output.

■ ES Discrete (DTS-ES Discrete)

This mode faithfully reproduces the sound design recorded in the DTS-ES Discrete audio format.

DTS-ES Discrete is used as an optional audio format on DVD-Video and Blu-ray Discs, based on 5.1ch, but with an additional monaural surround back channel added for a maximum of 6.1ch.

- To enable transfer of this audio format, connect via digital cable and set audio output on the player to bitstream output.

■ ES Matrix (DTS-ES Matrix)

This mode faithfully reproduces the sound design recorded in the DTS-ES Matrix audio format.

DTS-ES Matrix is used as an optional audio format on DVD-Video and Blu-ray Discs, based on 5.1ch, but with a monaural surround back channel included by matrix encoding. The matrix decoder on this unit decodes this during playback to produce 6.1 channels.

- To enable transfer of this audio format, connect via digital cable and set audio output on the player to bitstream output.

■ Full Mono

In this mode, all speakers output the same sound in mono, so the sound you hear is the same regardless of where you are within the listening room.

■ Game-Action

This mode is suitable for games with a lot of action.

■ Game-Rock

This mode is designed to help you enjoy games with rock content.

■ Game-RPG

This mode is best for role-playing games.

■ Game-Sports

This mode is great for sports games.

■ Mono

In this mode, when the input signal is analog or PCM, the left and right front speakers output the sound in monaural.

■ Multich (Multichannel)

Mode suitable for playing sources recorded in multichannel PCM.

■ Orchestra

Suitable for classical or operatic music. This mode emphasizes the surround channels in order to widen the sound image, and simulates the natural reverberation of a large hall.

■ Stereo

In this mode, sound is output from the front left and right speakers and subwoofer.

■ Studio-Mix

Suitable for rock or pop music. Listening to music in this mode creates a lively sound field with a powerful acoustic image, like being at a club or rock concert.

■ T-D (Theater-Dimensional)

In this mode, you can enjoy a virtual playback of multichannel surround sound even with only two or three speakers. This works by controlling how sounds reach the listener's left and right ears.

■ TV Logic

Suitable for TV shows produced in a TV studio. This mode enhances the surround effects to the entire sound to give clarity to voices and create a realistic acoustic image.

■ Unplugged

Suitable for acoustic instruments, vocals and jazz. This mode emphasizes the front stereo image, giving the impression of being right in front of the stage.

Selectable Listening Modes

You can select a variety of listening modes to suit the audio format of the signal being input. Refer to the following for the listening mode choices.

- Listening modes available when headphones are connected are: Mono, Direct, and Stereo.

■ MOVIE/TV button

This is a list of listening modes you can select according to the audio format of the input signal.

Input Format	Listening Mode
Analog	Direct
	Mono
	Dolby Surround
	DTS Neural:X
	TV Logic ^{*1}
	AllCh Stereo ^{*2}
	Full Mono ^{*2}
	T-D

^{*1} Surround speakers or height speakers need to be installed.

^{*2} A center speaker, surround speakers, or height speakers need to be installed.

Input Format	Listening Mode
PCM Music files (except DSD/ Dolby TrueHD)	Direct
	Mono
	Dolby Surround
	DTS Neural:X
	TV Logic ^{*1}
	AllCh Stereo ^{*2}
	Full Mono ^{*2}
	T-D

^{*1} Surround speakers or height speakers need to be installed.

^{*2} A center speaker, surround speakers, or height speakers need to be installed.

Input Format	Listening Mode
Multich PCM	Direct
	Multich ^{*1}
	Dolby Surround
	DTS Neural:X
	TV Logic ^{*2}
	AllCh Stereo ^{*3}
	Full Mono ^{*3}
	T-D

^{*1} A center speaker or surround speakers need to be installed.

^{*2} Surround speakers or height speakers need to be installed.

^{*3} A center speaker, surround speakers, or height speakers need to be installed.

Input Format	Listening Mode
DSD	Direct
	DSD ^{*1 *2}
	Dolby Surround
	DTS Neural:X
	TV Logic ^{*3}
	AllCh Stereo ^{*4}
	Full Mono ^{*4}
	T-D

^{*1} Cannot be selected when the input format is monaural or 2 ch.

^{*2} A center speaker or surround speakers need to be installed.

^{*3} Surround speakers or height speakers need to be installed.

^{*4} A center speaker, surround speakers, or height speakers need to be installed.

Input Format	Listening Mode
Dolby Atmos • You can select the Dolby Digital Plus or Dolby TrueHD listening modes if surround back speakers or height speakers are not connected.	Direct
	Dolby Atmos
	TV Logic
	AllCh Stereo
	Full Mono
	T-D

Input Format	Listening Mode
Dolby D	Direct
	Dolby D ^{*1 *2}
	Dolby Surround
	TV Logic ^{*3}
	AllCh Stereo ^{*4}
	Full Mono ^{*4}
	T-D

^{*1} Cannot be selected when the input format is 2 ch.
^{*2} A center speaker or surround speakers need to be installed.
^{*3} Surround speakers or height speakers need to be installed.
^{*4} A center speaker, surround speakers, or height speakers need to be installed.

Input Format	Listening Mode
Dolby D+	Direct
	Dolby D+ ^{*1 *2}
	Dolby Surround
	TV Logic ^{*3}
	AllCh Stereo ^{*4}
	Full Mono ^{*4}
	T-D

^{*1} Cannot be selected when the input format is 2 ch.
^{*2} A center speaker or surround speakers need to be installed.
^{*3} Surround speakers or height speakers need to be installed.
^{*4} A center speaker, surround speakers, or height speakers need to be installed.

Input Format	Listening Mode
Dolby TrueHD	Direct
	Dolby TrueHD ^{*1 *2}
	Dolby Surround
	TV Logic ^{*3}
	AllCh Stereo ^{*4}
	Full Mono ^{*4}
	T-D

^{*1} Cannot be selected when the input format is 2 ch.
^{*2} A center speaker or surround speakers need to be installed.
^{*3} Surround speakers or height speakers need to be installed.
^{*4} A center speaker, surround speakers, or height speakers need to be installed.

Input Format	Listening Mode
DTS	Direct
	DTS ^{*1 *2}
	DTS Neural:X
	TV Logic ^{*3}
	AllCh Stereo ^{*4}
	Full Mono ^{*4}
	T-D

^{*1} Cannot be selected when the input format is 2 ch.
^{*2} A center speaker or surround speakers need to be installed.
^{*3} Surround speakers or height speakers need to be installed.
^{*4} A center speaker, surround speakers, or height speakers need to be installed.

Input Format	Listening Mode
DTS 96/24	Direct
	DTS 96/24 ^{*1 *2}
	DTS Neural:X
	TV Logic ^{*3}
	AllCh Stereo ^{*4}
	Full Mono ^{*4}
	T-D

^{*1} Cannot be selected when the input format is 2 ch.
^{*2} A center speaker or surround speakers need to be installed.
^{*3} Surround speakers or height speakers need to be installed.
^{*4} A center speaker, surround speakers, or height speakers need to be installed.

Input Format	Listening Mode
DTS Express	Direct
	DTS Express ^{*1 *2}
	DTS Neural:X
	TV Logic ^{*3}
	AllCh Stereo ^{*4}
	Full Mono ^{*4}
	T-D

*1 Cannot be selected when the input format is 2 ch.

*2 A center speaker or surround speakers need to be installed.

*3 Surround speakers or height speakers need to be installed.

*4 A center speaker, surround speakers, or height speakers need to be installed.

Input Format	Listening Mode
DTS-HD HR	Direct
	DTS-HD HR ^{*1 *2}
	DTS Neural:X
	TV Logic ^{*3}
	AllCh Stereo ^{*4}
	Full Mono ^{*4}
	T-D

*1 Cannot be selected when the input format is 2 ch.

*2 A center speaker or surround speakers need to be installed.

*3 Surround speakers or height speakers need to be installed.

*4 A center speaker, surround speakers, or height speakers need to be installed.

Input Format	Listening Mode
DTS-HD MSTR	Direct
	DTS-HD MSTR ^{*1 *2}
	DTS Neural:X
	TV Logic ^{*3}
	AllCh Stereo ^{*4}
	Full Mono ^{*4}
	T-D

*1 Cannot be selected when the input format is 2 ch.

*2 A center speaker or surround speakers need to be installed.

*3 Surround speakers or height speakers need to be installed.

*4 A center speaker, surround speakers, or height speakers need to be installed.

Input Format	Listening Mode
DTS-ES	Direct
	DTS ^{*1}
	ES Matrix ^{*2}
	ES Discrete ^{*2}
	DTS Neural:X
	TV Logic ^{*3}
	AllCh Stereo ^{*4}
	Full Mono ^{*4}
	T-D

*1 This can only be selected when no surround back speaker is connected.

*2 Surround back speakers need to be installed.

*3 Surround speakers or height speakers need to be installed.

*4 A center speaker, surround speakers, or height speakers need to be installed.

Input Format	Listening Mode
DTS:X	Direct
	DTS:X
	TV Logic ^{*1}
	AllCh Stereo ^{*2}
	Full Mono ^{*2}
	T-D

*1 Surround speakers or height speakers need to be installed.

*2 A center speaker, surround speakers, or height speakers need to be installed.

■ **MUSIC button**

This is a list of listening modes you can select according to the audio format of the input signal.

Input Format	Listening Mode
Analog	Direct
	Stereo
	Dolby Surround
	DTS Neural:X
	Orchestra ^{*1}
	Unplugged ^{*1}
	Studio-Mix ^{*1}
	AllCh Stereo ^{*2}
	Full Mono ^{*2}

^{*1} Surround speakers or height speakers need to be installed.

^{*2} A center speaker, surround speakers, or height speakers need to be installed.

Input Format	Listening Mode
PCM Music files (except DSD/ Dolby TrueHD)	Direct
	Stereo
	Dolby Surround
	DTS Neural:X
	Orchestra ^{*1}
	Unplugged ^{*1}
	Studio-Mix ^{*1}
	AllCh Stereo ^{*2}
	Full Mono ^{*2}

^{*1} Surround speakers or height speakers need to be installed.

^{*2} A center speaker, surround speakers, or height speakers need to be installed.

Input Format	Listening Mode
Multich PCM	Direct
	Stereo
	Multich ^{*1}
	Dolby Surround
	DTS Neural:X
	Orchestra ^{*2}
	Unplugged ^{*2}
	Studio-Mix ^{*2}
	AllCh Stereo ^{*3}
	Full Mono ^{*3}

^{*1} A center speaker or surround speakers need to be installed.

^{*2} Surround speakers or height speakers need to be installed.

^{*3} A center speaker, surround speakers, or height speakers need to be installed.

Input Format	Listening Mode
DSD	Direct
	Stereo
	DSD ^{*1 *2}
	Dolby Surround
	DTS Neural:X
	Orchestra ^{*3}
	Unplugged ^{*3}
	Studio-Mix ^{*3}
	AllCh Stereo ^{*4}
Full Mono ^{*4}	

^{*1} Cannot be selected when the input format is monaural or 2 ch.

^{*2} A center speaker or surround speakers need to be installed.

^{*3} Surround speakers or height speakers need to be installed.

^{*4} A center speaker, surround speakers, or height speakers need to be installed.

Input Format	Listening Mode
Dolby Atmos • You can select the Dolby Digital Plus or Dolby TrueHD listening modes if surround back speakers or height speakers are not connected.	Direct
	Stereo
	Dolby Atmos
	Orchestra
	Unplugged
	Studio-Mix
	AllCh Stereo
	Full Mono

Input Format	Listening Mode
Dolby D	Direct
	Stereo
	Dolby D ^{*1 *2}
	Dolby Surround
	Orchestra ^{*3}
	Unplugged ^{*3}
	Studio-Mix ^{*3}
	AllCh Stereo ^{*4}
Full Mono ^{*4}	

- *1 Cannot be selected when the input format is 2 ch.
- *2 A center speaker or surround speakers need to be installed.
- *3 Surround speakers or height speakers need to be installed.
- *4 A center speaker, surround speakers, or height speakers need to be installed.

Input Format	Listening Mode
Dolby D+	Direct
	Stereo
	Dolby D+ ^{*1 *2}
	Dolby Surround
	Orchestra ^{*3}
	Unplugged ^{*3}
	Studio-Mix ^{*3}
	AllCh Stereo ^{*4}
Full Mono ^{*4}	

- *1 Cannot be selected when the input format is 2 ch.
- *2 A center speaker or surround speakers need to be installed.
- *3 Surround speakers or height speakers need to be installed.
- *4 A center speaker, surround speakers, or height speakers need to be installed.

Input Format	Listening Mode
Dolby TrueHD	Direct
	Stereo
	Dolby TrueHD ^{*1 *2}
	Dolby Surround
	Orchestra ^{*3}
	Unplugged ^{*3}
	Studio-Mix ^{*3}
	AllCh Stereo ^{*4}
Full Mono ^{*4}	

- *1 Cannot be selected when the input format is 2 ch.
- *2 A center speaker or surround speakers need to be installed.
- *3 Surround speakers or height speakers need to be installed.
- *4 A center speaker, surround speakers, or height speakers need to be installed.

Input Format	Listening Mode
DTS	Direct
	Stereo
	DTS ^{*1 *2}
	DTS Neural:X
	Orchestra ^{*3}
	Unplugged ^{*3}
	Studio-Mix ^{*3}
	AllCh Stereo ^{*4}
Full Mono ^{*4}	

- *1 Cannot be selected when the input format is 2 ch.
- *2 A center speaker or surround speakers need to be installed.
- *3 Surround speakers or height speakers need to be installed.
- *4 A center speaker, surround speakers, or height speakers need to be installed.

Input Format	Listening Mode
DTS 96/24	Direct
	Stereo
	DTS 96/24 ^{*1 *2}
	DTS Neural:X
	Orchestra ^{*3}
	Unplugged ^{*3}
	Studio-Mix ^{*3}
	AllCh Stereo ^{*4}
Full Mono ^{*4}	

- *1 Cannot be selected when the input format is 2 ch.
- *2 A center speaker or surround speakers need to be installed.
- *3 Surround speakers or height speakers need to be installed.
- *4 A center speaker, surround speakers, or height speakers need to be installed.

Input Format	Listening Mode
DTS Express	Direct
	Stereo
	DTS Express ^{*1 *2}
	DTS Neural:X
	Orchestra ^{*3}
	Unplugged ^{*3}
	Studio-Mix ^{*3}
	AllCh Stereo ^{*4}
Full Mono ^{*4}	

- *1 Cannot be selected when the input format is 2 ch.
- *2 A center speaker or surround speakers need to be installed.
- *3 Surround speakers or height speakers need to be installed.
- *4 A center speaker, surround speakers, or height speakers need to be installed.

Input Format	Listening Mode
DTS-HD HR	Direct
	Stereo
	DTS-HD HR ^{*1 *2}
	DTS Neural:X
	Orchestra ^{*3}
	Unplugged ^{*3}
	Studio-Mix ^{*3}
	AllCh Stereo ^{*4}
Full Mono ^{*4}	

^{*1} Cannot be selected when the input format is 2 ch.

^{*2} A center speaker or surround speakers need to be installed.

^{*3} Surround speakers or height speakers need to be installed.

^{*4} A center speaker, surround speakers, or height speakers need to be installed.

Input Format	Listening Mode
DTS-HD MSTR	Direct
	Stereo
	DTS-HD MSTR ^{*1 *2}
	DTS Neural:X
	Orchestra ^{*3}
	Unplugged ^{*3}
	Studio-Mix ^{*3}
	AllCh Stereo ^{*4}
Full Mono ^{*4}	

^{*1} Cannot be selected when the input format is 2 ch.

^{*2} A center speaker or surround speakers need to be installed.

^{*3} Surround speakers or height speakers need to be installed.

^{*4} A center speaker, surround speakers, or height speakers need to be installed.

Input Format	Listening Mode
DTS-ES	Direct
	Stereo
	DTS ^{*1}
	ES Matrix ^{*2}
	ES Discrete ^{*2}
	DTS Neural:X
	Orchestra ^{*3}
	Unplugged ^{*3}
	Studio-Mix ^{*3}
	AllCh Stereo ^{*4}
Full Mono ^{*4}	

^{*1} This can only be selected when no surround back speaker is connected.

^{*2} Surround back speakers need to be installed.

^{*3} Surround speakers or height speakers need to be installed.

^{*4} A center speaker, surround speakers, or height speakers need to be installed.

Input Format	Listening Mode
DTS:X	Direct
	Stereo
	DTS:X
	Orchestra ^{*1}
	Unplugged ^{*1}
	Studio-Mix ^{*1}
	AllCh Stereo ^{*2}
	Full Mono ^{*2}

^{*1} Surround speakers or height speakers need to be installed.

^{*2} A center speaker, surround speakers, or height speakers need to be installed.

■ GAME button

This is a list of listening modes you can select according to the audio format of the input signal.

Input Format	Listening Mode
Analog	Direct
	Dolby Surround
	DTS Neural:X
	Game-RPG ^{*1}
	Game-Action ^{*1}
	Game-Rock ^{*1}
	Game-Sports ^{*1}
	AllCh Stereo ^{*2}
	Full Mono ^{*2}
	T-D

^{*1} Surround speakers or height speakers need to be installed.

^{*2} A center speaker, surround speakers, or height speakers need to be installed.

Input Format	Listening Mode
PCM Music files (except DSD/ Dolby TrueHD)	Direct
	Dolby Surround
	DTS Neural:X
	Game-RPG ^{*1}
	Game-Action ^{*1}
	Game-Rock ^{*1}
	Game-Sports ^{*1}
	AllCh Stereo ^{*2}
	Full Mono ^{*2}
	T-D

^{*1} Surround speakers or height speakers need to be installed.

^{*2} A center speaker, surround speakers, or height speakers need to be installed.

Input Format	Listening Mode
Multich PCM	Direct
	Multich ^{*1}
	Dolby Surround
	DTS Neural:X
	Game-RPG ^{*2}
	Game-Action ^{*2}
	Game-Rock ^{*2}
	Game-Sports ^{*2}
	AllCh Stereo ^{*3}
	Full Mono ^{*3}
T-D	

^{*1} A center speaker or surround speakers need to be installed.

^{*2} Surround speakers or height speakers need to be installed.

^{*3} A center speaker, surround speakers, or height speakers need to be installed.

Input Format	Listening Mode
DSD	Direct
	DSD ^{*1 *2}
	Dolby Surround
	DTS Neural:X
	Game-RPG ^{*3}
	Game-Action ^{*3}
	Game-Rock ^{*3}
	Game-Sports ^{*3}
	AllCh Stereo ^{*4}
	Full Mono ^{*4}
T-D	

^{*1} Cannot be selected when the input format is monaural or 2 ch.

^{*2} A center speaker or surround speakers need to be installed.

^{*3} Surround speakers or height speakers need to be installed.

^{*4} A center speaker, surround speakers, or height speakers need to be installed.

Input Format	Listening Mode
Dolby Atmos • You can select the Dolby Digital Plus or Dolby TrueHD listening modes if surround back speakers or height speakers are not connected.	Direct
	Dolby Atmos
	Game-RPG
	Game-Action
	Game-Rock
	Game-Sports
	AllCh Stereo
	Full Mono
	T-D

Input Format	Listening Mode
Dolby D	Direct
	Dolby D ^{*1 *2}
	Dolby Surround
	Game-RPG ^{*3}
	Game-Action ^{*3}
	Game-Rock ^{*3}
	Game-Sports ^{*3}
	AllCh Stereo ^{*4}
	Full Mono ^{*4}
	T-D

^{*1} Cannot be selected when the input format is 2 ch.

^{*2} A center speaker or surround speakers need to be installed.

^{*3} Surround speakers or height speakers need to be installed.

^{*4} A center speaker, surround speakers, or height speakers need to be installed.

Input Format	Listening Mode
Dolby D+	Direct
	Dolby D+ ^{*1 *2}
	Dolby Surround
	Game-RPG ^{*3}
	Game-Action ^{*3}
	Game-Rock ^{*3}
	Game-Sports ^{*3}
	AllCh Stereo ^{*4}
	Full Mono ^{*4}
	T-D

- *1 Cannot be selected when the input format is 2 ch.
- *2 A center speaker or surround speakers need to be installed.
- *3 Surround speakers or height speakers need to be installed.
- *4 A center speaker, surround speakers, or height speakers need to be installed.

Input Format	Listening Mode
Dolby TrueHD	Direct
	Dolby TrueHD ^{*1 *2}
	Dolby Surround
	Game-RPG ^{*3}
	Game-Action ^{*3}
	Game-Rock ^{*3}
	Game-Sports ^{*3}
	AllCh Stereo ^{*4}
	Full Mono ^{*4}
	T-D

- *1 Cannot be selected when the input format is 2 ch.
- *2 A center speaker or surround speakers need to be installed.
- *3 Surround speakers or height speakers need to be installed.
- *4 A center speaker, surround speakers, or height speakers need to be installed.

Input Format	Listening Mode
DTS	Direct
	DTS ^{*1 *2}
	DTS Neural:X
	Game-RPG ^{*3}
	Game-Action ^{*3}
	Game-Rock ^{*3}
	Game-Sports ^{*3}
	AllCh Stereo ^{*4}
	Full Mono ^{*4}
	T-D

- *1 Cannot be selected when the input format is 2 ch.
- *2 A center speaker or surround speakers need to be installed.
- *3 Surround speakers or height speakers need to be installed.
- *4 A center speaker, surround speakers, or height speakers need to be installed.

Input Format	Listening Mode
DTS 96/24	Direct
	DTS 96/24 ^{*1 *2}
	DTS Neural:X
	Game-RPG ^{*3}
	Game-Action ^{*3}
	Game-Rock ^{*3}
	Game-Sports ^{*3}
	AllCh Stereo ^{*4}
	Full Mono ^{*4}
	T-D

- *1 Cannot be selected when the input format is 2 ch.
- *2 A center speaker or surround speakers need to be installed.
- *3 Surround speakers or height speakers need to be installed.
- *4 A center speaker, surround speakers, or height speakers need to be installed.

Input Format	Listening Mode
DTS Express	Direct
	DTS Express ^{*1 *2}
	DTS Neural:X
	Game-RPG ^{*3}
	Game-Action ^{*3}
	Game-Rock ^{*3}
	Game-Sports ^{*3}
	AllCh Stereo ^{*4}
	Full Mono ^{*4}
	T-D

- *1 Cannot be selected when the input format is 2 ch.
- *2 A center speaker or surround speakers need to be installed.
- *3 Surround speakers or height speakers need to be installed.
- *4 A center speaker, surround speakers, or height speakers need to be installed.

Input Format	Listening Mode
DTS-HD HR	Direct
	DTS-HD HR ^{*1 *2}
	DTS Neural:X
	Game-RPG ^{*3}
	Game-Action ^{*3}
	Game-Rock ^{*3}
	Game-Sports ^{*3}
	AllCh Stereo ^{*4}
	Full Mono ^{*4}
	T-D

- *1 Cannot be selected when the input format is 2 ch.
- *2 A center speaker or surround speakers need to be installed.
- *3 Surround speakers or height speakers need to be installed.
- *4 A center speaker, surround speakers, or height speakers need to be installed.

Input Format	Listening Mode
DTS-HD MSTR	Direct
	DTS-HD MSTR ^{*1 *2}
	DTS Neural:X
	Game-RPG ^{*3}
	Game-Action ^{*3}
	Game-Rock ^{*3}
	Game-Sports ^{*3}
	AllCh Stereo ^{*4}
	Full Mono ^{*4}
T-D	

^{*1} Cannot be selected when the input format is 2 ch.

^{*2} A center speaker or surround speakers need to be installed.

^{*3} Surround speakers or height speakers need to be installed.

^{*4} A center speaker, surround speakers, or height speakers need to be installed.

Input Format	Listening Mode
DTS-ES	Direct
	DTS ^{*1}
	ES Matrix ^{*2}
	ES Discrete ^{*2}
	DTS Neural:X
	Game-RPG ^{*3}
	Game-Action ^{*3}
	Game-Rock ^{*3}
	Game-Sports ^{*3}
	AllCh Stereo ^{*4}
	Full Mono ^{*4}
T-D	

^{*1} This can only be selected when no surround back speaker is connected.

^{*2} Surround back speakers need to be installed.

^{*3} Surround speakers or height speakers need to be installed.

^{*4} A center speaker, surround speakers, or height speakers need to be installed.

Input Format	Listening Mode
DTS:X	Direct
	DTS:X
	Game-RPG ^{*1}
	Game-Action ^{*1}
	Game-Rock ^{*1}
	Game-Sports ^{*1}
	AllCh Stereo ^{*2}
	Full Mono ^{*2}
T-D	

^{*1} Surround speakers or height speakers need to be installed.

^{*2} A center speaker, surround speakers, or height speakers need to be installed.

Internet Radio

You can use internet radio services such as TuneIn Radio, Pandora, Deezer, and TIDAL by connecting this unit to a network that has an internet connection.

- Depending on the internet radio service, the user may need to register from their computer first. Refer to the websites for each of the services for details about them.
- Functionality may be introduced by firmware updates and service providers may cease services, meaning that some network services and content may become unavailable in the future.

■ Playing Back

1. Switch the input on the TV to that assigned to the unit.
2. Press NET on the remote controller to display a list of Network Functions on the TV.

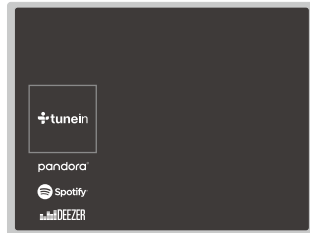

3. Select the internet radio service you want with the cursors of the remote controller and press ENTER to confirm your selection.
4. Follow the on-screen instructions, using the cursors on the remote controller to select radio stations and programs, then press ENTER to play.
 - To return to the previous screen, press ↶.

■ Internet radio service menus

You can register certain stations as your favorites or delete stations you have registered from your favorites. The menu displayed depends on the service currently selected.

Menu icons (⊕) are displayed at the bottom right of the screen while playing a station. When just this icon is displayed, you can display the menu on the screen just by pressing ENTER on the remote controller. When multiple icons are displayed, select an (⊕) icon with the cursors of the remote controller and press ENTER.

■ Regarding the TuneIn Radio Account

Creating an account on the TuneIn Radio website (tunein.com) and logging in it from the unit allows you to automatically add your favorite radio stations and programs to your "My Presets" on the unit as you follow them on the website. "My Presets" are displayed in the level under TuneIn Radio.

To display a radio station registered in "My Presets", you must log into TuneIn Radio from the unit. To log in, select "Login" - "I have a TuneIn account" in the "TuneIn Radio" top list on the unit, and then enter your user name and password.

- If you select "Login" on this unit, you can use the displayed registration code to associate this device on the My Page section of the TuneIn Radio website so that you can login to "Login" - "Login with a registration code" without having to enter your user name and password.

Spotify

Spotify Connect play is possible by connecting this unit to the same network as a smart phone or tablet.

- To play Spotify Connect, you need to install the Spotify application on your smartphone or tablet. You also need to create a Spotify premium account.
- Refer to the following for Spotify settings:
www.spotify.com/connect/

■ Playing Back

1. Connect the smartphone to the access point that this unit is connected to.
2. Start the Spotify app.
3. Play the track in the Spotify app, then after switching to the screen for controlling play, tap "Devices Available" at the bottom of the screen.

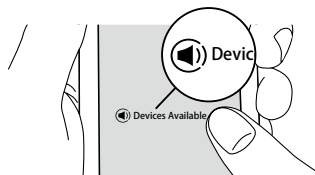

4. Select this unit.
5. This unit turns on automatically and the input selector changes to NET and streaming of Spotify starts.
 - If "5. Hardware" - "Power Management" - "Network Standby" is set to "Off" in the Setup menu, manually turn the unit on and then press NET on the remote controller.

■ Notes for using multi-zone (for compatible models only)

- To enjoy Spotify music in a separate room, manually select "NET" as the input of the separate room. After doing that, select this unit with the Spotify app.
- Volume adjustment with the Spotify app is possible only for speakers connected to the ZONE speaker terminals or when the volume of the audio device in the other room is configured so that its volume can be adjusted on this unit. Adjust the volume on the audio equipment in the other room in any other case.
- To enjoy Spotify music in the main room after playing it in a separate room, select "NET" as the input of the main room.

AirPlay®

You can also play the music files on a computer with iTunes (Ver. 10.2 or later). Before operation, make sure this unit and the PC are connected to the same network, then press NET on this unit. Next, click the AirPlay icon  in iTunes, select this unit from the list of devices displayed, and start play of a music file.

You can wirelessly enjoy the music files on an iPhone®, iPod touch®, or iPad® connected to the same access point as this unit.

- Update the OS version on your iOS device to the latest version.
 - There may be some differences in the operations screens and how operations are performed on the iOS device depending on the iOS version. For details, see the operating instructions for the iOS device.
1. Connect the iOS device to the access point.
 2. Press NET.
 3. Tap the AirPlay icon  in the play screen of the music app on the iOS device and select this unit from the list of devices displayed.

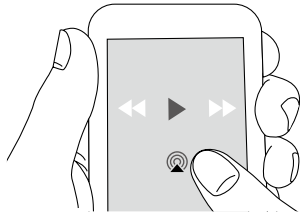

4. Play the music files on the iOS device.
- The default status is for the Network Standby feature to be on, so when you do steps 3 and 4 above, this unit automatically comes on and input switches to "NET". To reduce the amount of power consumed in standby mode, press the  button on the remote controller, then in the Setup menu displayed set "5. Hardware" - "Power Management" - "Network Standby" to "Off".
 - Due to the characteristics of AirPlay wireless technology, the sound produced on this unit may slightly be behind the sound played on the AirPlay-enabled device.

Music Server

Overview

Streaming play of music files stored on PCs or NAS devices connected to the same network as this unit is supported.

- The network servers this unit is compatible with are those PCs with players installed that have the server functionality of Windows Media® Player 11 or 12, or NAS that are compatible with home network functionality. You may need to make some settings in advance to use Windows Media® Player 11 or 12. Note that with PCs, only music files registered in the library of Windows Media® Player can be played.

Configuring the Windows Media® Player

■ Windows Media® Player 11

- Turn on your PC and start Windows Media® Player 11.
- In the "Library" menu, select "Media Sharing" to display a dialog box.
- Select the "Share my media" check box, and then click "OK" to display the compatible devices.
- Select this unit, and then click "Allow".
 - When it is clicked, the corresponding icon is checked.
- Click "OK" to close the dialog.
 - Depending of the version of Windows Media® Player, there may be differences in the names of items you can select.

■ Windows Media® Player 12

- Turn on your PC and start Windows Media® Player 12.
- In the "Stream" menu, select "Turn on media streaming" to display a dialog box.
 - If media streaming is already turned on, select "More streaming options..." in the "Stream" menu to list players in the network, and then go to step 4.
- Click "Turn on media streaming" to list players in the network.
- Select this unit in "Media streaming options" and check that it is set to "Allow".
- Click "OK" to close the dialog.
 - Depending of the version of Windows Media® Player, there may be differences in the names of items you can select.

Play

- Start the server (Windows Media® Player 11, Windows Media® Player 12, or NAS device) containing the music files to play.
- Make sure that the PCs and/or NASs are properly connected to the same network as this unit.
- Press NET on the remote controller to display the network service list screen.
 - If the "NET" indicator flashes in the display, the unit is not properly connected to the network. Check the connection.

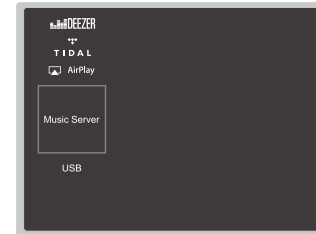

- With the cursors on the remote controller, select "Music Server", and then press ENTER.
- Select the target server with the cursors on the remote controller and press ENTER to display the items list screen.
 - The unit cannot access pictures and videos stored on servers.
 - Contents stored on the server may not be displayed depending on the server sharing settings.
- With the cursors on the remote controller, select the music file to play, and then press ENTER to start playback.
 - If "No Item." is displayed, check whether the network is properly connected.
- To return to the previous screen, press ↶.
- For music files on a server, there can be up to 20,000 tracks per folder, and folders may be nested up to 16

levels deep.

- Depending on the media server, the unit may not recognize it, or may not be able to play its music files.

Controlling Remote Playback from a PC

You can use this unit to play music files stored on your PC by operating the PC inside your home network. The unit supports remote playback with Windows Media® Player 12. To use the remote playback function with Windows Media® Player 12, it must be configured in advance.

■ Setting PC

1. Turn on your PC and start Windows Media® Player 12.
2. In the "Stream" menu, select "Turn on media streaming" to display a dialog box.
 - If media streaming is already turned on, select "More streaming options..." in the "Stream" menu to list players in the network, and then go to step 4.
3. Click "Turn on media streaming" to list players in the network.
4. Select this unit in "Media streaming options" and check that it is set to "Allow".
5. Click "OK" to close the dialog box.
6. Open the "Stream" menu and check that "Allow remote control of my Player..." is checked.
 - Depending of the version of Windows Media® Player, there may be differences in the names of items you can select.

■ Remote playback

1. Turn on the power of the unit.
2. Turn on your PC and start Windows Media® Player 12.
3. Select and right-click the music file to play with Windows Media® Player 12.
 - To remotely play a music file on another server, open the target server from "Other Libraries" and select the music file to play.
4. Select this unit in "Play to" to open the "Play to" window of Windows Media® Player 12 and start playback on the unit.
 - If your PC is running on Windows® 8.1, click "Play

to", and then select this unit. If your PC is running on Windows® 10, click "Cast to Device", and select this unit. Operations during remote playback are possible from the "Play to" window on the PC. The playback screen is displayed on the TV connected to the HDMI output of the unit.

5. Adjust the volume using the volume bar on the "Play to" window.
 - Sometimes, the volume displayed on the remote playback window may differ from that appeared on the display of the unit.
 - When the volume is adjusted from the unit, the value is not reflected in the "Play to" window.
 - This unit cannot play music files remotely in the following conditions.
 - It is using a network service.
 - It is playing a music file on a USB storage device.
- Depending of the version of Windows Media® Player, there may be differences in the names of items you can select.

Supplementary information for player functions

Due to firmware (the software for the system) updates after you make your purchase or firmware changes during production of the product, there may be additions or changes to the features available compared to what is in the instruction manual.

For information about player functions that have been added or changed, see the following references. Refer to "Supplementary Information, etc." - "Supplementary Information" for information about changes to settings, etc., other than player functions.

[Supplementary information for player functions](#)

>>> [Click here](#) <<<



Troubleshooting

Before starting the procedure

Problems may be solved by simply turning the power on/off or disconnecting/connecting the power cord, which is easier than working on the connection, setting and operating procedure. Try the simple measures on both the unit and the connected device. If the problem is that the video or audio is not output or the HDMI linked operation does not work, disconnecting/connecting the HDMI cable may solve it. When reconnecting, be careful not to wind the HDMI cable since if wound the HDMI cable may not fit well. After reconnecting, turn off and on the unit and the connected device.

- This unit contains a microPC for signal processing and control functions. In very rare situations, severe interference, noise from an external source, or static electricity may cause it to lockup. In the unlikely event that this happens, unplug the power cord from the wall outlet, wait at least 5 seconds, and then plug it back in.
- Our company is not responsible for reparations for damages (such as CD rental fees) due to unsuccessful recordings caused by the unit's malfunction. Before you record important data, make sure that the material will be recorded correctly.

When the unit is operating erratically

■ Try restarting the unit

Restarting the unit may help it operate more smoothly. To restart the unit, turn it to standby, and then press **⏻** ON/STANDBY on the main unit for at least 5 seconds. (The unit's settings will be maintained.) If there is no improvement even after the unit is restarted, try disconnecting and reconnecting the power cords of the unit and connected equipment.

■ Resetting the unit (this resets the unit settings to the default)

If restarting the unit doesn't fix the problem, resetting the unit to the status at the time of shipment may solve the problem. If you reset the unit status, your preferences will be reset to the defaults. Note them down before the operation below.

1. While pressing the CBL/SAT input selector button on the main unit, press **⏻** ON/STANDBY.
2. "Clear" appears on the display and the unit returns to standby. Do not unplug the power cord until "Clear" disappears from the display.

To reset the remote controller, while holding down MODE, press **↔/↔** until the remote indicator flashes twice (3 seconds or more).

Power

■ Cannot turn on the unit

- Make sure that the power cord is properly plugged into the wall outlet.
- Unplug the power cord from the wall outlet, wait 5 seconds or more, then plug it in again.

■ The unit turns off unexpectedly

- The unit automatically switches to standby when the "Hardware" - "Power Management" - "Auto Standby" setting in the Setup menu functions.
- The protective circuit function may have been activated. If this has occurred, "AMP Diag Mode" appears on the display when the unit is turned on again, and the unit enters diagnostic mode. If the results of the diagnosis is that there is no problem, the "AMP Diag Mode" display disappears and you can use the unit normally again. If "CHECK SP WIRE" appears on the display, the speaker cables may be short-circuited. Make sure bare speaker wires are not touching each other or the back panel of the unit, then turn the unit on again. If "NG" is displayed, immediately unplug the power cord from the wall outlet and contact your dealer.
- The protective circuit function may have been activated because the temperature of the unit rose abnormally. If this happens, then the power will continue to turn off after you have turned the unit on again. Make sure the unit has plenty of space for ventilation around it, wait for the unit to cool down sufficiently, and then try turning it on again.

WARNING: If smoke, smell or abnormal noise is produced by the unit, unplug the power cord from the wall outlet immediately and contact the dealer or our company's support.

Audio

- Make sure that the speaker setup microphone is not still connected.
- Confirm that the connection between the output jack on the device and the input jack on this unit is correct.
- Make sure that none of the connecting cables are bent, twisted, or damaged.
- If the MUTE indicator on the display flashes, press  on the remote controller to cancel muting.
- While headphones are connected to the PHONES jack, no sound is output from the speakers.
- When "Source" - "Audio Select" - "PCM Fixed Mode" in the Setup menu is set to "On", no sound is played when signals other than PCM are input. Change the setting to Off.

Check the following if the above does not fix the problem:

■ There is no sound from the TV

- Change the input selector on this unit to the position of the terminal to which the TV is connected.
- If the TV doesn't support the ARC function, along with connection by HDMI, connect the TV and this unit using a digital optical cable, digital coaxial cable, or analog audio cable.

■ No sound from a connected player

- Change the input selector on this unit to the position of the terminal to which the player is connected.
- Check the digital audio output setting on the connected component. On some game consoles, such as those that support DVD, the default setting is off.
- With some DVD-Video discs, you need to select an audio output format from a menu.

■ A speaker produces no sound

- Make sure that the polarity of the speaker cables (+/-) is correct, and that no bare wires are in contact with the metal part of speaker terminals.
- Make sure that the speaker cables are not shorting.
- Check in "Connect the Speakers" in the Basic Manual that the speaker connections have been made correctly. Settings for the speaker connection environment need

to be made in "AccuEQ Room Calibration" in Initial Setup. Check in "Initial Setup" in the Basic Manual.

- Depending on the source and current listening mode, not much sound may be produced. Select another listening mode to see if sound is output.
- If you are installing surround back speakers (for compatible models only), surround speakers are required.
- A maximum of 5.1 ch playback is possible when Bi-Amping connection is used (for compatible models only). Further, make sure you remove the jumper bar on the speakers when using Bi-Amping connection.

■ The subwoofer produces no sound

If the setting of the front speakers is "Full Band" and during 2ch input such as from the TV or music, the low range elements will be output from the front speakers rather than from the subwoofer. If you would rather output from the subwoofer, make one of the following settings.

1. Change the front speakers settings to a setting other than "Full Band" for the crossover frequency value. The range below the frequency you specify will be output from the subwoofer rather than the front speakers. We do not recommend changing this if your front speakers have good low range reproduction capabilities.
 2. Change "Double Bass" to "On". The low range elements will be output from both the front speakers and the subwoofer. This may mean that there is too much bass. Do not change if this happens, or choose option 1.
- Refer to "Setup Menu" - "2. Speaker" - "Crossover" in the Advanced Manual for details.
 - When you play source material that contains no information in the LFE channel, the subwoofer produces no sound.

■ Noise can be heard

- Using cable ties to bundle analog audio cables, power cords, speaker cables, etc. may degrade the audio performance. Do not bundle cords.
- An audio cable may be picking up interference. Try repositioning your cables.

■ The beginning of audio received by an HDMI IN cannot be heard

- Since it takes longer to identify the format of an HDMI signal than it does for other digital audio signals, audio output may not start immediately.

■ Sound suddenly reduces

- When the temperature inside the unit exceeds a certain temperature for extended periods, the volume may be reduced automatically to protect the circuits.

Listening Modes

- To enjoy digital surround playback, such as Dolby Digital, the audio signals need to pass through a connection via HDMI cable, digital coaxial cable, or digital optical cable. Audio output should be set to bitstream output on the connected Blu-ray Disc player or other device.
- Press **i** on the remote controller several times to switch the display of the main unit to check the input format.

Check the following if the above does not fix the problem:

■ Cannot select a desired listening mode

- Depending on the connecting status of the speaker, some listening modes may not be selected. Check in "Selectable Listening Modes" in "Listening Modes" in the Advanced Manual.

■ There is no sound with Dolby TrueHD, Dolby Atmos, and DTS-HD Master Audio (for compatible models only)

- You need to connect surround back speakers or height speakers to enjoy Dolby Atmos. Furthermore, Dolby Atmos can only be enjoyed when the input signals are Dolby Atmos.
- If you cannot output formats such as Dolby TrueHD, Dolby Atmos, or DTS-HD Master Audio according to the format of the source, in the Blu-ray Disc player settings try setting "BD video supplementary sound" (or re-encode, secondary sound, video additional audio, etc.) to "Off". Change the listening mode for each source after changing the setting to confirm.

■ Cannot select Pure Audio mode (for compatible models only)

- The Pure Audio mode cannot be selected while the Multi-zone feature (for compatible models only) is on.

■ About DTS signals

- With media that switches suddenly from DTS to PCM, PCM playback may not start immediately. In such cases, you should stop your player for about 3 seconds and then resume playback.

- With some CD and LD players, you will not be able to playback DTS material properly even though your player is connected to a digital input on the unit. This is usually because the DTS bitstream has been processed (e.g., output level, sampling rate, or frequency response changed) and the unit does not recognize it as a genuine DTS signal. In such cases, you may hear noise.
- Playing DTS program material, using the pause or skip function on your player may produce a short audible noise. This is not a malfunction.

Video

- Confirm that the connection between the output jack on the device and the input jack on this unit is correct.
- Make sure that none of the connecting cables are bent, twisted, or damaged.
- When the TV image is blurry or unclear, power code or connection cables of the unit may have interfered. In that case, keep distance between TV antenna cable and cables of the unit.
- Make sure the switching of input screens is proper at the monitor side such as a TV.

Check the following if the above does not fix the problem:

■ There is no video

- Change the input selector on this unit to the position of the terminal to which the player is connected.
- While the listening mode is Pure Audio (for compatible models only), the video signals input through jacks other than the HDMI IN jack cannot be shown.

■ There is no picture from a source connected to an HDMI IN terminal.

- To display video from the connected player on the TV while the unit is in standby, you need to enable "Hardware" - "HDMI" - "HDMI Standby Through" in the Setup menu. Refer to "Setup Menu" - "5. Hardware" - "■ 1. HDMI" in "Advanced Setup" in the Advanced Manual for information about HDMI Standby Through.
- To output video to a TV connected to the HDMI OUT SUB jack (for compatible models only), in the "Quick Menu" displayed when Q is pressed on the remote controller, select the HDMI OUT jack for output in "Other" - "HDMI Out".
- Check if "Resolution Error" is displayed on the main unit display when video input via HDMI IN jack is not displayed. In this case, the TV does not support the resolution of the video input from the player. Change the setting on the player.
- Reliable operation with an HDMI-DVI adapter is not guaranteed. In addition, video signals from a PC are not supported.

■ Images flicker

- It is possible that the resolution of the player is not compatible with the TV's resolution. If you have connected the player to this unit with an HDMI cable, try changing the output resolution on the player. There also may be an improvement if you change the screen mode on the TV.

■ Video and audio are out of synch

- Video may be delayed relative to audio depending on the settings and connections with your television. To adjust, press Q on the remote controller, and adjust in "Other" - "A/V Sync" in the "Quick Menu".

Linked operation

■ There is no linked operation with CEC compliant devices, such as a TV.

- In the Setup menu of the unit, set "Hardware" - "HDMI" - "HDMI CEC" to "On".
- It is also necessary to set HDMI linking on the CEC compliant device. Check the instruction manual.

Tuner

■ Radio reception is poor or there is a lot of noise.

- Re-check the antenna connection.
- Relocate your antenna.
- Move the unit away from your TV or PC.
- Passing cars and airplanes can cause interference.
- Concrete walls weaken radio signals.
- Listen to the station in mono.
- When listening to an AM station, operating the remote controller may cause noise.
- FM reception may become clearer if you use the antenna jack on the wall used for the TV.

BLUETOOTH function

- Try plugging/unplugging the power of the unit and try turning on/off the BLUETOOTH wireless technology enabled device. Re-startup of the BLUETOOTH wireless technology enabled device may be effective.
- The BLUETOOTH wireless technology enabled devices must support the A2DP profile.
- Near components such as microwave oven or cordless phone, which use the radio wave in the 2.4 GHz range, a radio wave interference may occur, which disables the use of this unit.
- If there is a metallic object near the unit, BLUETOOTH connection may not be possible as the metal can effect on the radio waves.

Check the following if the above does not fix the problem:

■ Cannot connect with this unit

- Check that the BLUETOOTH function of the BLUETOOTH wireless technology enabled device is enabled.

■ Music playback is unavailable on the unit even after successful BLUETOOTH connection

- When the audio volume of your BLUETOOTH wireless technology enabled device is set low, the playback of audio may be unavailable. Volume up the BLUETOOTH wireless technology enabled device.
- Depending on the BLUETOOTH wireless technology enabled device, Send/Receive selector switch may be provided. Select Send mode.
- Depending on the characteristics or specifications of your BLUETOOTH wireless technology enabled device, playback on the unit is not guaranteed.

■ Sound is interrupted

- Problem may be occurring at the BLUETOOTH wireless technology enabled device. Check the information on the internet.

■ The audio quality is poor after connection with a BLUETOOTH wireless technology enabled device

- The BLUETOOTH reception is poor. Move the BLUETOOTH wireless technology enabled device

closer to the unit or remove any obstacle between the BLUETOOTH wireless technology enabled device and this unit.

Network function

- If you cannot select a network service, it will become selectable when the network function is started. It may take about a minute to start up.
- When NET is blinking, this unit is not properly connected to the home network.
- Try plugging/unplugging the power supply of this unit and the router, and try rebooting the router.
- If the desired wireless LAN router is not in the access point list, it may be set to hide SSID or the ANY connection may be off. Change the setting and try again.

Check the following if the above does not fix the problem:

■ Cannot access the Internet radio

- Certain network service or contents available through the unit may not be accessible in case the service provider terminates its service.
- Make sure that your modem and router are properly connected, and make sure they are both turned on.
- Make sure that the LAN side port on the router is properly connected to this unit.
- Make sure that connecting to Internet from other components is possible. If connecting is not possible, turn off all components connected to the network, wait for a while, and then turn on the components again.
- If a specific radio station is unavailable for listening, make sure the registered URL is correct, or whether the format distributed from the radio station is supported by this unit.
- Depending on ISP, setting the proxy server is necessary.
- Make sure that the used router and/or modem is supported by your ISP.

■ Cannot access the network server

- This unit needs to be connected to the same router as the network server.
- This unit is compatible with Windows Media® Player 11 or 12 network servers or NAS that are compatible with home network functionality.
- You may need to make some settings on Windows Media® Player. Check in "Music Server" in "Network Functions" in the Advanced Manual.

- When using a PC, only music files registered in the Windows Media® Player library can be played.

■ Playback stops while listening to music files on the network server

- Make sure the network server is compatible with this unit.
- When the PC is serving as the network server, try quitting any application software other than the server software (Windows Media® Player 12, etc.).
- If the PC is downloading or copying large files, the playback may be interrupted.

USB storage device

■ USB storage device is not displayed

- Check whether the USB storage device or USB cable is correctly inserted to the USB port of the unit.
- Disconnect the USB storage device from the unit, and then try reconnecting.
- Performance of the hard disk that receive power from the USB port of the unit is not guaranteed.
- Depending on the type of format, the playback may not be performed normally. Check the type of the file formats that is supported.
- USB storage devices with security functions may not be played.

Wireless LAN Network

- Try plugging/unplugging the power supply of wireless LAN router and the unit, check the wireless LAN router power-on status, and try reboot of the wireless LAN router.

Check the following if the above does not fix the problem:

■ Cannot access wireless LAN network

- The wireless LAN router setting may be switched to Manual. Return the setting to Auto.
- Try the manual set-up. The connection may succeed.
- When the wireless LAN router setting is at stealth mode (mode to hide the SSID key) or when ANY connection is off, the SSID is not displayed. Change the setting and try again.
- Check that the setting of SSID and encryption (WEP, etc.) is correct. Make sure the network settings of the unit is properly set.
- Connection to an SSID that includes multi-byte characters is not supported. Name the SSID of the wireless LAN router using single-byte alphanumeric characters only and try again.

■ Connected to an SSID different to the SSID selected

- Some wireless LAN routers allow you to set multiple SSIDs for one unit. If you use the automatic setting button on such a router, you may end up connecting with a different SSID from the SSID you wanted to connect to. Use the connection method requiring you to enter a password if this happens.

■ Playback is interrupted and communication does not work

- You may not receive radio waves due to bad radio wave conditions. Shorten the distance from the wireless LAN access point or remove obstacles to improve visibility, and try again. Place the unit away from microwave ovens or other access points. It is recommended to place the wireless LAN router (access point) and the unit in the same room.
- If there is a metallic object near the unit, wireless LAN connection may not be possible as the metal can effect

on the radio wave.

- When other wireless LAN devices are used near the unit, several issues such as interrupted playback and communication may occur. You can avoid these issues by changing the channel of your wireless LAN router. For instructions on changing channels, see the instruction manual provided with your wireless LAN router.
- There may not be enough bandwidth available in wireless LAN. Connect using an Ethernet cable.

Multi-zone function (for compatible models only)

■ Cannot ZONE output audio of external AV component

- Depending on the model, input by HDMI cable may not be supported. Check in "Multi-zone Connection" in the Basic Manual, and if input by HDMI cable is not supported, connect using a cable that is supported.
- The audio from externally connected AV components can only be output when the audio is analog or 2ch PCM audio signals. If you have connected the AV component to this unit with a digital optical/coaxial cable, the audio output of the AV component needs to be set to PCM.

■ Others

- Settings are required in Initial Setup, "Multi Zone Setup" to use the multi-zone feature. Check in "Initial Setup" in the Basic Manual.
- If the audio signal is from the NET input selector, zone output is not possible for DSD and Dolby TrueHD audio signals.

Remote Controller

- Make sure that the batteries are installed with the correct polarity.
- Install new batteries. Do not mix different types of batteries, or old and new batteries.
- Make sure that the unit is not subjected to direct sunshine or inverter-type fluorescent lights. Relocate if

necessary.

- If the unit is installed in a rack or cabinet with colored-glass doors or if the doors are closed, the remote controller may not work reliably.
- After operating the Multi-zone function (for compatible models only), the remote controller may have switched to the mode for operating ZONE output audio. Check "Multi-zone" in "Playback" in the Basic Manual to switch the remote controller back to the mode for operating in the main room.

Display

■ The display doesn't light

- The display may go dim while the Dimmer is working, and may also turn off (for compatible models only). Press DIMMER button and change the brightness level of the display.
- The display is turned off when the Pure Audio (for compatible models only) listening mode is selected.

Others

■ Strange noises can be heard from the unit

- If you have connected another unit to the same wall outlet as this unit, this noise may be an effect from the other unit. If the symptoms improve by unplugging the power cord of the other unit, use different wall outlets for this unit and the other unit.

■ When performing AccuEQ Room Calibration, the message "Noise Error" appears

- This can be caused by a malfunction in your speaker unit. Check if the speakers produce normal sounds.

■ The results of AccuEQ Room Calibration give a different distance to the speakers than the actual distance

- There may be some discrepancies in the results depending on the speakers you are using. If this is the case, make the settings in "2. Speaker" - "Distance" in the Setup menu.

Information about products with Wi-Fi/ BLUETOOTH features

■ Radio Wave Caution

Products with Wi-Fi/BLUETOOTH use radio waves in the 2.4 GHz and 5 GHz frequency bands. There are nations and regions where the use of particular 5 GHz bands are prohibited outdoors, so do not use these products outside.

2.4 GHz radio waves are used by a variety of devices, as shown in lists 1 and 2 below.

1. Devices which use a 2.4 GHz radio wave frequency
 - Cordless phones
 - Cordless facsimiles
 - Microwave ovens
 - Wireless LAN devices (IEEE802.11b/g/n)
 - Wireless AV equipment
 - Wireless controllers for game systems
 - Microwave oven-based health aids
 - Video transmitter
 - Specific type of external monitor and LCD display
2. Less common devices which use a 2.4 GHz radio wave frequency
 - Anti-theft systems
 - Amateur radio stations (HAM)
 - Warehouse logistic management systems
 - Discrimination systems for train or emergency vehicles

If these devices and the AV receiver are used at the same time, the audio may be undesirably stopped or disturbed due to a radio wave interference.

Suggestions for improvement

- Switch off the devices which emit the radio wave.
- Place the interfering devices away from the AV receiver.
- The AV receiver uses radio wave, and a third person can receive the wave on purpose or accidentally. Do not use the communication for important or fatal matters.
- We assume no responsibility whatsoever for any error or damage of network environment or access device resulting from the use of this apparatus.

Confirm with the provider or access device maker for more information.

■ Scope of Operation

Use of the AV receiver is limited to home use. (Transmission distances may be reduced depending on communication environment.)

In the following locations, poor condition or inability to receive radio waves may cause the audio to be interrupted or stopped:

- In reinforced concrete buildings or steel framed or iron framed buildings.
- Near large metallic furniture.
- In a crowd of people or near a building or obstacle.
- In a location exposed to the magnetic field, static electricity or radio wave interference from radio communication equipment using the same frequency band (2.4 GHz) as the AV receiver, such as a 2.4 GHz wireless LAN device (IEEE802.11b/g/n) or microwave oven.
- If you live in a heavily populated residential area (apartment, townhouse, etc.) and if your neighbor's microwave oven is placed near your AV receiver, you may experience radio wave interference. If this occurs, move your AV receiver to a different place. When the microwave oven is not in use, there will be no radio wave interference.

■ Radio Wave Reflections

The radio waves received by the AV receiver include the radio wave coming directly from the devices and waves coming from various directions due to reflections by walls, furniture and building (reflected waves). The reflected waves (due to obstacles and reflecting objects) further produce a variety of reflected waves as well as variation in reception condition depending on locations. If the audio cannot be received properly due to this phenomenon, try moving the location of the wireless LAN device a little. Also note that audio may be interrupted due to the reflected waves when a person crosses or approaches

the space between the AV receiver and the wireless LAN device.

- We assume no responsibility whatsoever for any damages resulting from the use of this apparatus except in the cases deemed acceptable under the applicable laws and regulations.
- Operation in all environment is not guaranteed for wireless LAN. The communication may not be possible or have desirable communication speed.

■ Precautions

- Do not use this apparatus near an electronic device handling high-accuracy controls or weak signals. Doing so may cause an accident due to a malfunction of the device.
- Do not use this apparatus in use prohibited location such as an aircraft equipment or a hospital. Doing so may cause an accident due to a malfunction of an electronic device or an electro-medical apparatus. Follow the instructions of the medical facilities.

Electronic device which requires cautions

Hearing aid, pace maker, other medical electronic devices, fire alarm, automatic door, and other automatic control device.

When using a pace maker or other medical electronic devices, confirm with the medical electronic device maker or dealer for the effect of the radio wave.

Supplementary Information

Due to firmware (the software for the system) updates after you make your purchase or firmware changes during production of the product, there may be additions or changes to the settings and operation available compared to what is in the instruction manual.

For information about the settings and operations that have been added or changed, see the following references. Refer to "Network Functions" - "Supplementary information for player functions" for information about changes to player functions.

[Supplementary Information](#)

>>> [Click here](#) <<<



License and Trademark

DOLBY ATMOS

Manufactured under license from Dolby Laboratories. Dolby, Dolby Atmos, Dolby Surround, Dolby Vision and the double-D symbol are trademarks of Dolby Laboratories.



For DTS patents, see <http://patents.dts.com>. Manufactured under license from DTS, Inc. DTS, the Symbol, DTS in combination with the Symbol, DTS:X, and the DTS:X logo are registered trademarks or trademarks of DTS, Inc. in the United States and/or other countries. © DTS, Inc. All Rights Reserved.



The terms HDMI and HDMI High-Definition Multimedia Interface, and the HDMI Logo are trademarks or registered trademarks of HDMI Licensing LLC in the United States and other countries.



The Wi-Fi CERTIFIED Logo is a certification mark of Wi-Fi Alliance®.



AirPlay, iPad, iPhone, iPod, iPod classic, iPod nano and iPod touch are trademarks of Apple Inc., registered in the U.S. and other countries.

iPad Air and iPad mini are trademarks of Apple Inc.

"Made for iPod", "Made for iPhone" and "Made for iPad"

mean that an electronic accessory has been designed to connect specifically to iPod, iPhone, or iPad, respectively, and has been certified by the developer to meet Apple performance standards. Apple is not responsible for the operation of this device or its compliance with safety and regulatory standards.

Please note that the use of this accessory with iPod, iPhone or iPad may affect wireless performance.

AirPlay works with iPhone, iPad, and iPod touch with iOS 4.3.3 or later, Mac with OS X Mountain Lion or later, and PC with iTunes 10.2.2 or later.



The BLUETOOTH® word mark and logos are registered trademarks owned by Bluetooth SIG, Inc.

pandora®

PANDORA, the PANDORA logo, and the Pandora trade dress are trademarks or registered trademarks of Pandora Media, Inc. Used with permission.

The Spotify software is subject to third party licenses found here: <https://developer.spotify.com/esdk-third-party-licenses/>

This product is protected by certain intellectual property rights of Microsoft. Use or distribution of such technology outside of this product is prohibited without a license from Microsoft.

Windows 7, Windows Media, and the Windows logo are trademarks or registered trademarks of Microsoft Corporation in the United States and/or other countries.

"x.v.Color" and "x.v.Color" logo are trademarks of Sony Corporation.

DSD and the Direct Stream Digital logo are trademarks of Sony Corporation.



Theater-Dimensional

"Theater-Dimensional" and "Theater-Dimensional (logo)" are trademarks of Onkyo Corporation.

All other trademarks are the property of their respective owners. / Toutes les autres marques commerciales sont la propriété de leurs détenteurs respectifs. / El resto de marcas comerciales son propiedad de sus respectivos propietarios. / Tutti gli altri marchi di fabbrica sono di proprietà dei rispettivi proprietari. / Alle anderen Warenzeichen sind das Eigentum ihrer jeweiligen Eigentümer. / Alle andere handelsmerken zijn eigendom van de desbetreffende rechthebbenden. / Alla andra varumärken tillhör deras respektive ägare. / Kaikki muut tuotemerkit ovat omistajiensa omaisuutta. / 所有其他商標為各自所有者所有。

ONKYO

1-10-5 Yokoami, Sumida-ku, Tokyo 130-0015 JAPAN
<http://www.onkyo.com/>

<U.S.A.>

18 Park Way, Upper Saddle River, N.J. 07458, U.S.A.
For Dealer, Service, Order and all other Business Inquiries:
Tel: 201-785-2600 Fax: 201-785-2650
<http://www.us.onkyo.com/>

For Product Support Team Only:
1-800-229-1687
<http://www.us.onkyo.com/>

<Germany>

Gutenbergstrasse 3, 82178 Puchheim, Germany
Tel: +49-8142-4401-0 Fax: +49-8142-4208-213
<http://www.eu.onkyo.com/>

<UK>

Anteros Building, Odyssey Business Park, West End Road, South Ruislip, Middlesex,
HA4 6QQ United Kingdom
Tel: +44 (0)871-200-1996 Fax: +44 (0)871-200-1995
For Product Support only: +44 (0)208-836-3510
<http://www.uk.onkyo.com/en/>

<France>

6, Avenue de Marais F - 95816 Argenteuil Cedex FRANCE
For Product Support only: +33 969 368 138
<http://www.fr.onkyo.com/fr/>

<Hong Kong>

Unit 1033, 10/F, Star House, No 3, Salisbury Road, Tsim Sha Tsui Kowloon, Hong Kong.
Tel: +852-2429-3118 Fax: +852-2428-9039
<http://www.hk.onkyo.com/>

<PRC>

302, Building 1, 20 North Chaling Rd., Xuhui District, Shanghai, China 200032,
Tel: +86-21-52131366 Fax: +86-21-52130396
<http://www.cn.onkyo.com/>

<Asia, Oceania, Middle East, Africa>

Please contact an Onkyo distributor referring to Onkyo SUPPORT site.
<http://www.intl.onkyo.com/support/>

The above-mentioned information is subject to change without prior notice.
Visit the Onkyo web site for the latest update.

SN 29402933 PDF_EN

(C) Copyright 2017 Onkyo & Pioneer Corporation Japan. All rights reserved.
Onkyo group has established its Privacy Policy, available at [<http://www.onkyo.com/privacy/>].

F1711-1



* 2 9 4 0 2 9 3 3 *