

# CG 6200

- Ⓓ Kaffee-Espresso-Vollautomat
- Ⓖᵇ Fully Automatic Espresso Maker
- Ⓕ Machine à café/espresso entièrement automatique
- Ⓓᵛ Volautomatische koffie- en espressomachine
- Ⓘ Macchina espresso automatica
- Ⓔ Máquina automática para Café Espresso
- ⒫ Máquina de café Espresso- totalmente automática
- Ⓐ Kaffe-espresso helautomat
- Ⓕᵛ Täysin automaattinen espressokahviasema
- Ⓒᶻ Zcela automatický automat na espresso
- ⒫ᵛ Automat do kawy espresso
- Ⓕ Kávéautomata
- Ⓕᵛᵀ Κοφεβάρκα-αυτοματ
- Ⓖᵛ Πλήρως αυτόματη μηχανή εσπρέσσο

Gebrauchsanweisung  
Operating instructions

Mode d'emploi

Gebruiksaanwijzing

Istruzione per l'uso

Instrucciones de uso

Instruções de serviço

Bruksanvisning

Käyttöohje

Návod k použití

Instrukcja obsługi

Használati útmutató

Руководство по эксплуатации

Εγχειρίδιο οδηγιών χρήσης

PERFEKT IN FORM UND FUNKTION

**AEG**

 Electrolux

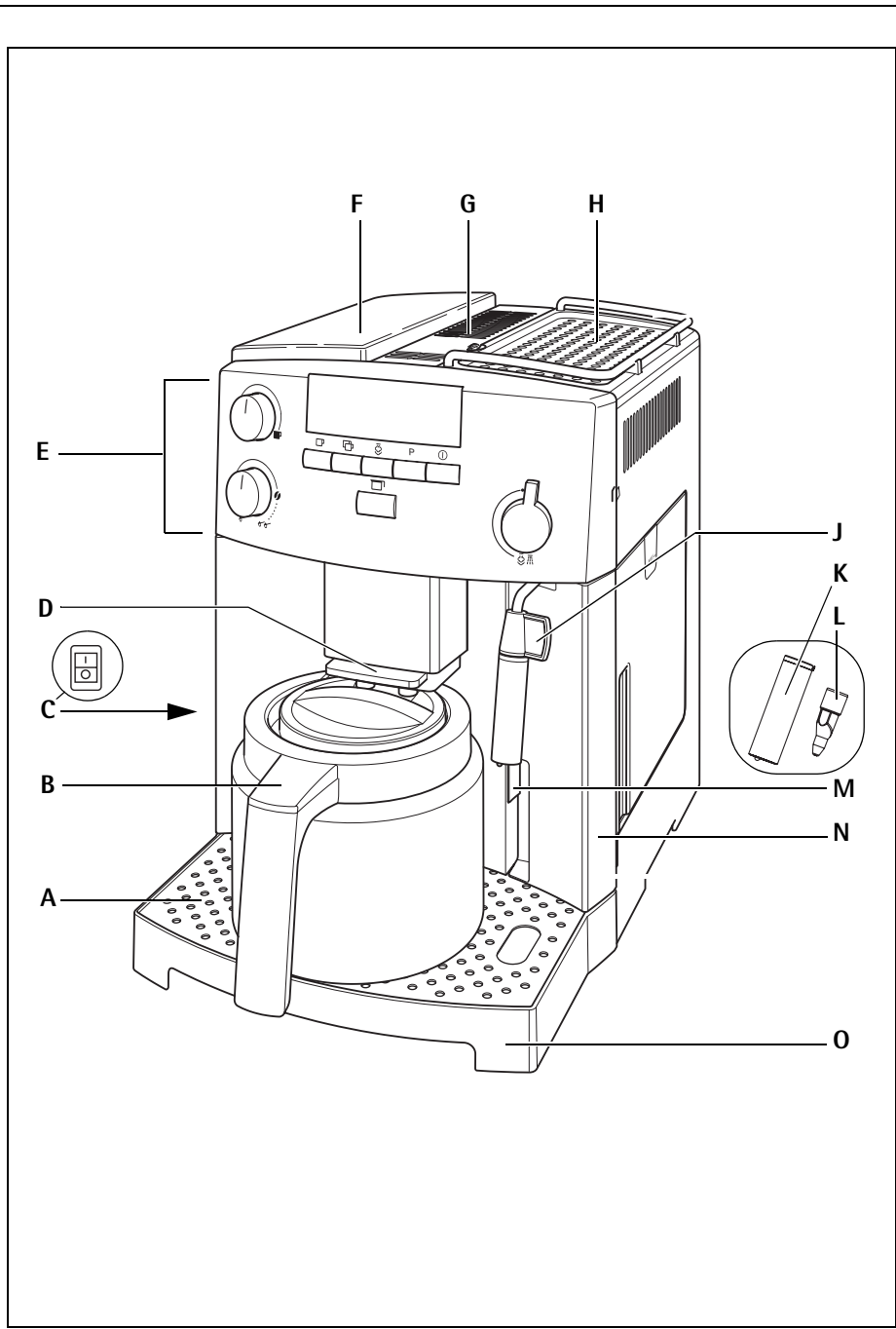

1

2

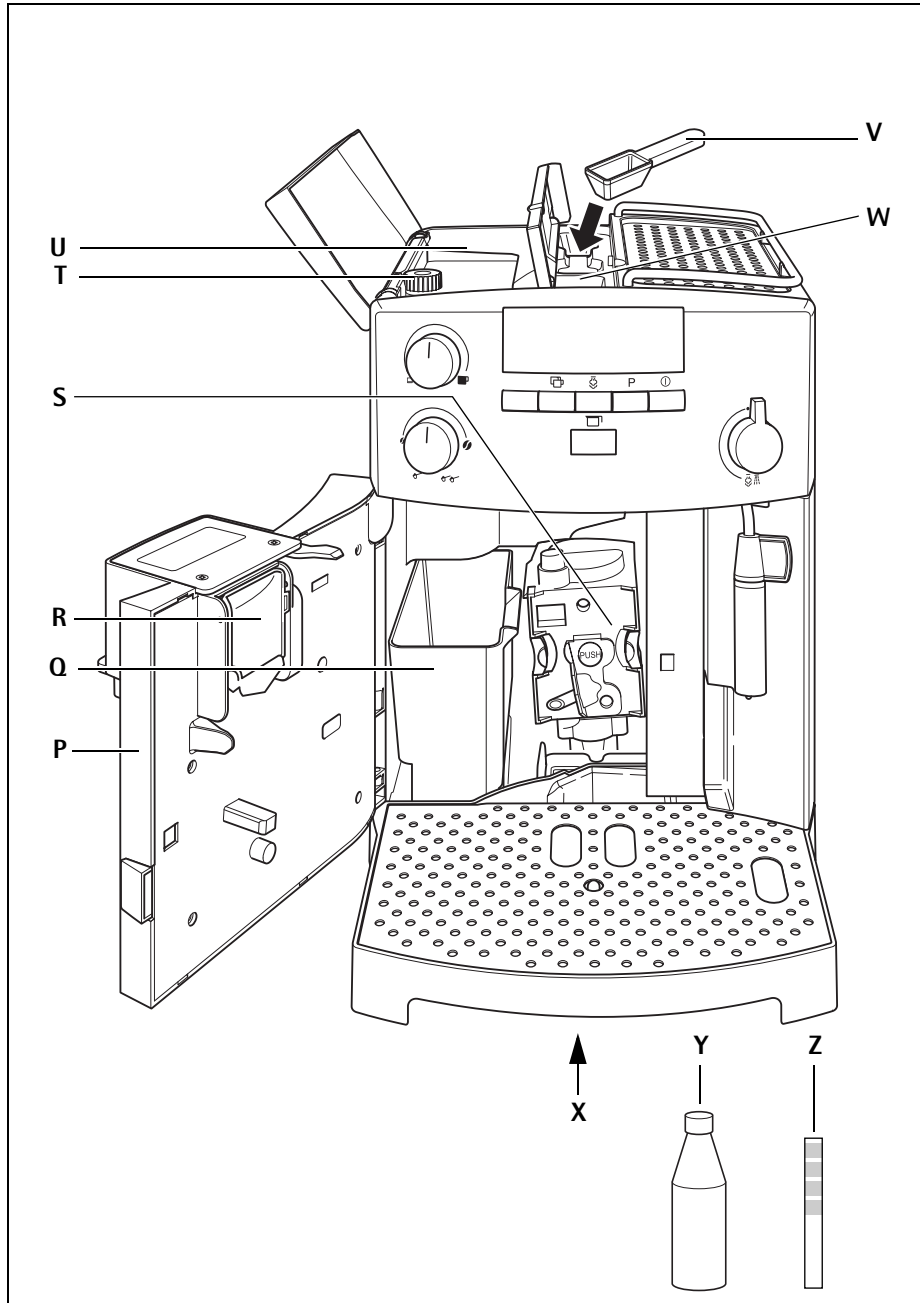

2

3



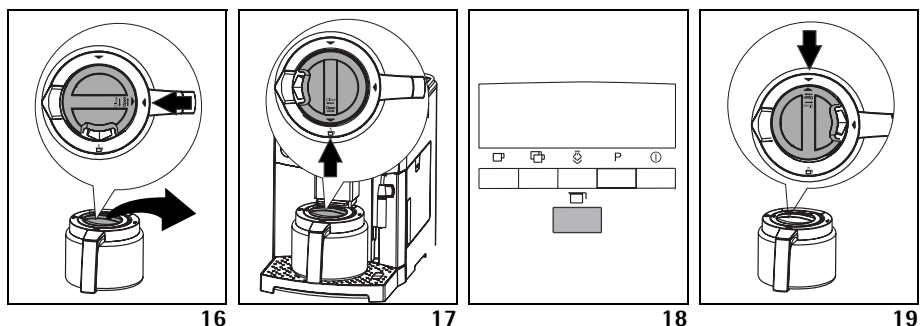
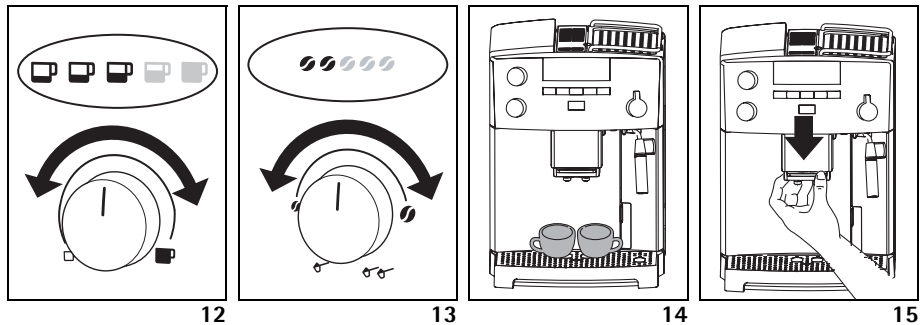
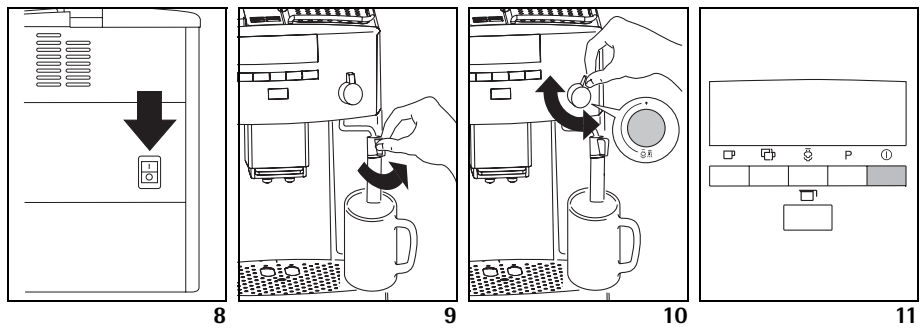
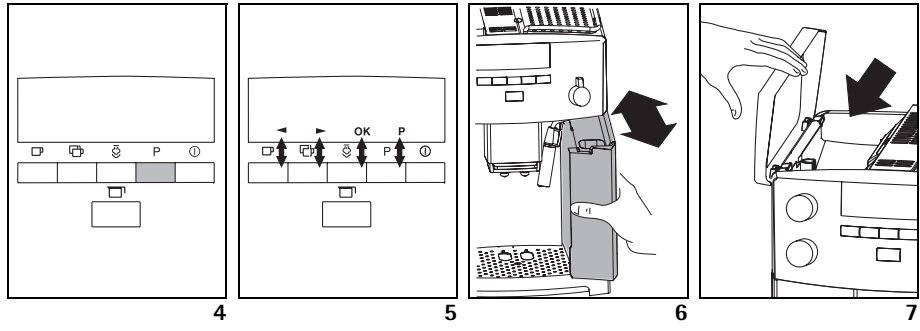

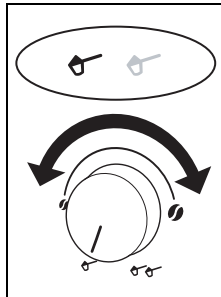

20

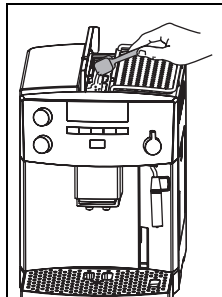

21

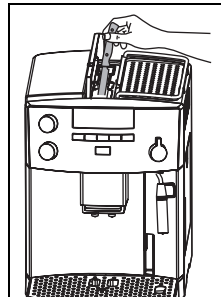

22

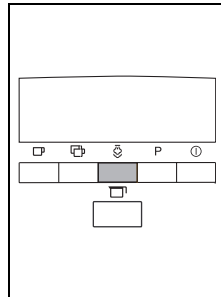

23

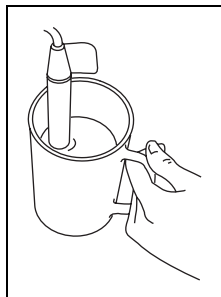

24

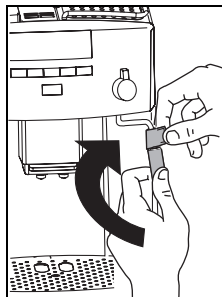

25

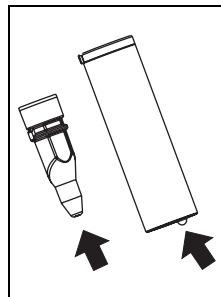

26

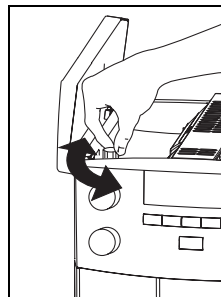

27

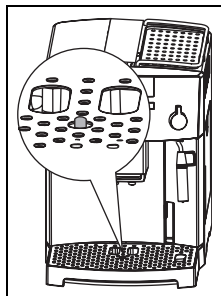

28

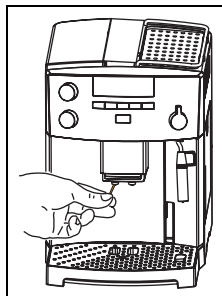

29

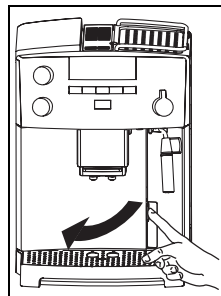

30

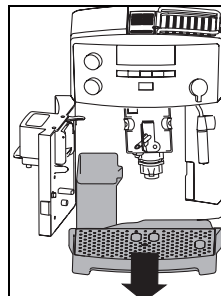

31

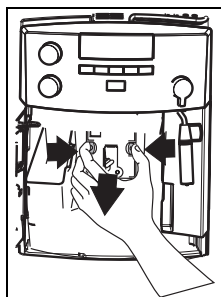

32

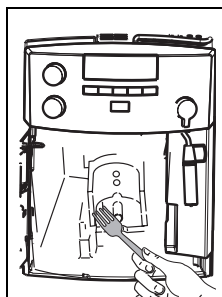

33

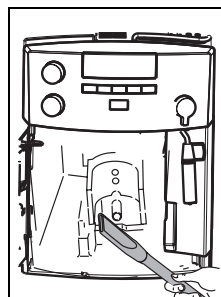

34

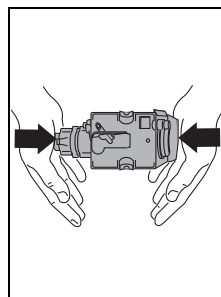

35

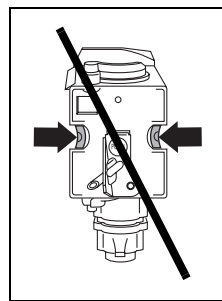
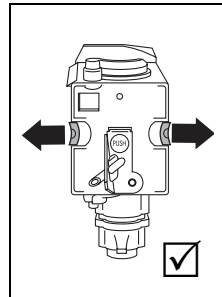
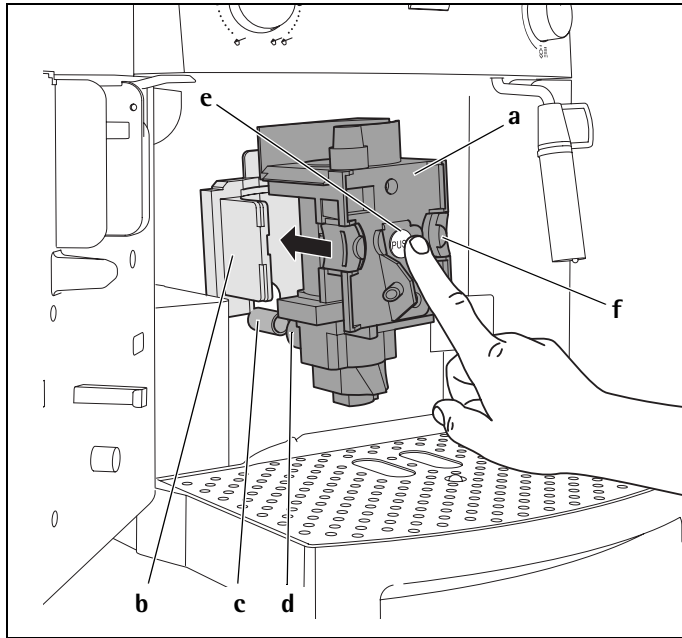

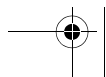
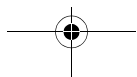
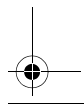
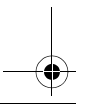
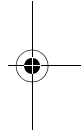
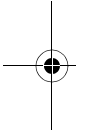
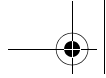



## D Sehr geehrte Kundin, sehr geehrter Kunde,

lesen Sie bitte diese Gebrauchsanweisung sorgfältig durch. Beachten Sie vor allem die Sicherheitshinweise! Bewahren Sie die Gebrauchsanleitung zum späteren Nachschlagen auf und geben Sie sie an eventuelle Nachbesitzer des Gerätes weiter.

### Inhaltsverzeichnis

<b>1 Bildlegende</b>	<b>10</b>	<b>10 Heisswasserzubereitung</b>	<b>21</b>
1.1 Vorderansicht (Bild 1)	10	<b>11 Mahlgrad einstellen</b>	<b>21</b>
1.2 Vorderansicht mit offener Servicetür (Bild 2)	10	<b>12 Kaffeetemperatur einstellen</b>	<b>22</b>
1.3 Bedienfeld (Bild 3)	10	<b>13 Reinigung und Pflege</b>	<b>22</b>
<b>2 Kaffee und Espresso</b>	<b>11</b>	13.1 Regelmäßige Reinigung	22
<b>3 Sicherheitshinweise</b>	<b>11</b>	13.2 Tresterbehälter leeren	23
<b>4 Spezial-Modus</b>	<b>13</b>	13.3 Mahlwerk reinigen	23
<b>5 Erste Inbetriebnahme</b>	<b>13</b>	13.4 Brüheinheit reinigen	23
5.1 Gerät aufstellen und anschließen	13	13.5 Entkalkungsprogramm durchführen	24
5.2 Wasser einfüllen	13	<b>14 Bestellung von Zubehör</b>	<b>26</b>
5.3 Kaffeebohnenbehälter befüllen	13	<b>15 Was ist zu tun, wenn auf dem Display folgende Symbole angezeigt werden...</b>	<b>26</b>
5.4 Erstes Einschalten	14	<b>16 Lösbare Probleme, bevor Sie den Kundendienst rufen</b>	<b>27</b>
5.5 Gerät einschalten	14	<b>17 Statistik-Modus</b>	<b>29</b>
5.6 Gerät ausschalten	14	<b>18 Technische Daten</b>	<b>30</b>
5.7 Wasserhärte einstellen	15	<b>19 Entsorgung</b>	<b>30</b>
<b>6 Kaffee mit Bohnen zubereiten</b>	<b>16</b>	<b>20 Im Service-Fall</b>	<b>30</b>
6.1 Tipps für die Ausgabe eines heißeren Kaffees	17		
<b>7 Mehrere Tassen Kaffee mit der Kannen-Funktion zubereiten</b>	<b>17</b>		
<b>8 Kaffee mit Pulver zubereiten</b>	<b>18</b>		
<b>9 Milch aufschäumen</b>	<b>19</b>		
9.1 Dampfdüse reinigen	20		

D

## 1 Bildlegende

### 1.1 Vorderansicht (Bild 1)

- A Tropfgitter
- B Warmhaltekanne
- C Hauptschalter (Geräterückseite)
- D Höhenverstellbarer Kaffeeauslauf
- E Bedienfeld (siehe Bild 3)
- F Deckel für Kaffeebohnenbehälter
- G Deckel für Kaffeepulverschacht
- H Beheizte Tassenablage
- J Schwenkrohr für Dampf und Heißwasser
- K Dampfdüse (abnehmbar)
- L Dampfdüsen-Innenteil (abnehmbar)
- M Öffnungsknopf für Servicetür
- N Wassertank mit Max-Marke (entnehmbar)
- O Abtropfschale mit Schwimmer (entnehmbar)

### 1.2 Vorderansicht mit offener Servicetür (Bild 2)

- P Servicetür (offen)
- Q Tresterbehälter (herausnehmbar)
- R Schwenkfach
- S Brüheinheit
- T Knopf für die Mahlgradeinstellung
- U Kaffeebohnenbehälter
- V Messlöffel
- W Einfüllschacht für vorgemahlenes Kaffeepulver
- X Typschild (Geräteunterseite)
- Y Flüssigentkalker
- Z Teststreifen













### 1.3 Bedienfeld (Bild 3)

- a Drehknopf "Kaffeestärke / vorgemahlener Kaffee"
- b Drehknopf "Tassengröße"
- c Display
- d Taste "1 Tasse Kaffee" 

Im Spezial-Modus dient diese Taste für das „Blättern“ (" $<$ ")
- e Taste "2 Tassen Kaffee" 

In Spezial-Modus dient diese Taste für das „Blättern“ (" $>$ ")
- f Taste "Dampf" 

Im Spezial-Modus bestätigt diese Taste den Menüpunkt ("OK")
- g Taste „P“
 

Im Spezial-Modus kehrt diese Taste in die letzte Ebene zurück, ohne Änderungen vorzunehmen ("P")
- h Taste "Ein/Aus" 
- j Drehknopf für Dampf und Heißwasser
- k Taste "Kanne" 
- l Symbole "Vorgemahlener Kaffee"
- m Symbole "Kanne"
- n Symbole "Kaffeestärke"
- o Symbole "Tassengröße"
- p Symbol "Wassertank leer" 
- q Symbol "Entkalken" 
- r Symbol "Gerätetemperatur" 
- s Symbol "Servicetür offen" 
- t Symbol "Tresterbehälter" 
- u Symbol "Achtung" 
- v Symbol "Heisswasser" 
- w Symbol "Dampf" 
- x Symbol "Zubereitung 2 Tassen" 
- y Symbol "Zubereitung 1 Tasse" 
- z Symbole für den Spezial-Modus

## 2 Kaffee und Espresso

Die Funktion Ihres Vollautomaten garantiert Ihnen einfachste **Bedienung**, bei der Kaffeezubereitung ebenso wie bei der Wartung und Pflege.

Der vorzügliche, individuelle **Geschmack** wird erreicht durch

- das Vorbrühsystem: vor dem eigentlichen Brühvorgang wird das Kaffeemehl angefeuchtet, um das gesamte Aroma auszuschöpfen,
- die individuell einstellbare Wassermenge pro Tasse zwischen kurzem Espresso und „langem“ Kaffee mit Crema,
- die individuell einstellbare Kaffeetemperatur, mit der der Kaffee gebrüht wird,
- die Wahlmöglichkeit zwischen einer normalen oder starken Tasse Kaffee,
- den auf die Röstung der Bohnen einstellbaren Mahlgrad,
- und nicht zuletzt durch die garantierte Crema, jenes Schaumkrönchen, das den Espresso-Kaffee für Kenner so unvergleichbar macht.

**Übrigens:** Die Kontaktzeit des Wassers mit dem Kaffeemehl ist bei Espresso-Kaffee wesentlich kürzer als bei herkömmlichem Filterkaffee. Damit werden weniger Bitterstoffe aus dem Kaffeemehl herausgelöst, was den Espresso-Kaffee viel bekömmlicher macht!

## 3 Sicherheitshinweise



Die Sicherheit dieses Geräts entspricht den anerkannten Regeln der Technik und dem Gerätesicherheitsgesetz. Dennoch sehen wir uns als Hersteller veranlasst, Sie mit den nachfolgenden Sicherheitshinweisen vertraut zu machen.

### Allgemeine Sicherheit

- Das Gerät darf nur an ein Stromnetz angeschlossen werden, dessen Spannung, Stromart und Frequenz mit den Angaben auf dem Typschild (siehe Unterseite des Gerätes) übereinstimmen!
- Die Zuleitung nie mit heißen Geräteteilen in Berührung bringen.
- Den Netzstecker nie an der Zuleitung aus der Steckdose ziehen!
- Das Gerät nicht in Betrieb nehmen, wenn:
  - die Zuleitung beschädigt ist oder
  - das Gehäuse sichtbare Beschädigungen aufweist.
- Netzstecker nur bei ausgeschaltetem Gerät in die Steckdose einstecken.
- Dieses Gerät ist nicht dazu bestimmt, von Personen (einschließlich Kinder), die aufgrund Ihrer Unerfahrenheit oder Unkenntnis nicht in der Lage sind es sicher zu bedienen oder von Personen (einschließlich Kinder) mit eingeschränkten physischen, sensorischen oder geistigen Fähigkeiten, benutzt oder betrieben zu werden, es sei denn sie wurden durch eine für sie verantwortliche Person angewiesen wie das Gerät sicher zu benutzen ist und anfänglich von ihr beaufsichtigt.

### Sicherheit von Kindern

- Lassen Sie das Gerät nicht unbeaufsichtigt laufen und wahren Sie gegenüber Kindern eine besondere Aufsichtspflicht!
- Verpackungsmaterial, wie z.B. Folienbeutel, gehören nicht in Kinderhände.

D

### Sicherheit beim Betrieb

- **Achtung! Kaffeeauslauf, Dampfdüse und Tassenablage werden funktionsbedingt während des Betriebes heiß. Kinder fernhalten!**
- **Achtung! Verbrühungsgefahr bei aktivierter Dampfdüse! Austretendes Heißwasser bzw. heißer Wasserdampf kann zu Verbrühungen führen. Aktivieren Sie die Dampfdüse nur, wenn Sie ein Behältnis unter die Dampfdüse halten.**
- Keine entzündbaren Flüssigkeiten mit Dampf erhitzen!
- Das Gerät nur betreiben, wenn sich Wasser im System befindet! Nur kaltes Wasser in den Wassertank einfüllen, kein heißes Wasser, Milch oder andere Flüssigkeiten. Beachten Sie die max. Füllmenge von ca. 1,8 Litern.
- Keine gefrorenen oder karamellisierten Kaffeebohnen in den Bohnenbehälter geben, nur geröstete Kaffeebohnen! Entfernen Sie Fremdkörper, wie z.B. Steinchen, aus den Kaffeebohnen. Blockierung oder Beschädigung verursacht durch Fremdkörper im Mahlwerk können von der Garantie ausgeschlossen sein.
- Nur Kaffeepulver in den Pulvereinwurf geben.
- Gerät nicht unnötig eingeschaltet lassen.
- Gerät nicht Witterungseinflüssen aussetzen.
- Bei Verwendung eines Verlängerungskabels nur ein handelsübliches Kabel mit einem Leiterquerschnitt von mindestens 1,5 mm<sup>2</sup> benutzen.
- Personen mit motorischen Störungen sollten das Gerät nie ohne Begleitperson benutzen, um eine Gefährdung zu vermeiden.
- **Das Gerät nur betreiben, wenn die Tropfschale, der Tresterbehälter und das Tropfgitter eingesetzt sind!**

### Sicherheit bei Reinigung und Pflege

- Reinigungs- und Entkalkungshinweise beachten.
- Vor Wartung oder Reinigung Gerät ausschalten und Netzstecker ziehen!
- Gerät nicht in Wasser tauchen.
- Die Dampfdüse nur in ausgeschaltetem, kaltem und drucklosen Zustand reinigen!
- Geräteteile nicht im Geschirrspüler reinigen.
- **Niemals Wasser in das Mahlwerk geben, dadurch wird das Mahlwerk beschädigt.**

Das Gerät weder öffnen noch reparieren. Durch unsachgemäße Reparaturen können erhebliche Gefahren für den Benutzer entstehen.



Reparaturen an Elektrogeräten dürfen nur von Fachkräften durchgeführt werden.



Bei einer evtl. erforderlichen Reparatur, einschließlich Ersatz der Netzzuleitung, wenden Sie sich bitte

- an den Fachhändler, bei dem Sie das Gerät erworben haben, oder
- an die AEG/Electrolux Serviceline.

**Wird das Gerät zweckentfremdet oder falsch bedient, kann keine Haftung für eventuelle Schäden oder Garantie übernommen werden – ebenso, wenn das Entkalkungsprogramm nicht umgehend nach Erscheinen des Symbols  und nach den Angaben in dieser Gebrauchsanweisung durchgeführt werden. Blockierung oder Beschädigung verursacht durch Fremdkörper im Mahlwerk können von der Garantie ausgeschlossen sein.**

## 4 Spezial-Modus

Für das Einstellen der Wasserhärte („Wasserhärte einstellen“ Seite 15) und der Kaffeetemperatur („Kaffeetemperatur einstellen“ Seite 22), zum Starten des Entkalkungsprogramms („Entkalkungsprogramm durchführen“ Seite 24) und um die Statistik einzusehen („Statistik-Modus“ Seite 29), wird durch Drücken der Taste „P“ (Bild 4) in den Spezial-Modus umgeschaltet. Im Spezial-Modus dienen die Tasten "1 Tasse Kaffee" , "2 Tassen Kaffee" , "Dampf"  und „P“ zum Navigieren. Die jeweilige Funktion ist im Display über der Taste angegeben (Bild 5):

- «<» ("1 Tasse Kaffee" ) und «>» ("2 Tassen Kaffee" ) erlauben das „Blättern“
- «OK» ("Dampf" ) bestätigt einen Punkt
- «P» („P“) kehrt in die letzte Ebene zurück, ohne eine Änderung vorzunehmen

## 5 Erste Inbetriebnahme

### 5.1 Gerät aufstellen und anschließen

Wählen Sie einen geeigneten, waagerechten, stabilen, unbeheizten, trockenen und wasserfesten Untergrund.

- ⚠ Achten Sie auf gute Luftzirkulation. An den Seiten und der Rückseite des Gerätes muss ein Freiraum von mindestens 5 cm, und über dem Gerät von mindestens 20 cm vorhanden sein.

Das Gerät darf nicht in Räumen aufgestellt werden, in denen Temperaturen von 0°C oder darunter vorkommen können (Gerätebeschädigung durch gefrierendes Wasser).

- ⚠ Achtung! Wenn das Gerät aus der Kälte kommend in einem warmen Raum aufgestellt wird, ca. 2 Stunden mit dem Einschalten warten!

Wir empfehlen eine geeignete Unterlage unter das Gerät zu legen, um

Beschädigungen durch Spritzer zu vermeiden.

- ✋ Schließen Sie das Gerät ausschließlich an eine geerdete Steckdose an. Benutzen Sie keine nicht geerdete Steckdose.

### 5.2 Wasser einfüllen

Vergewissern Sie sich vor jedem Einschalten, ob sich Wasser im Wassertank befindet und füllen Sie gegebenenfalls auf. Das Gerät benötigt bei jedem Einschalt- bzw. Ausschaltvorgang Wasser für die automatischen Spülvorgänge.

- ✋ Entnehmen Sie den Wassertank aus dem Gerät (Bild 6). Drehen Sie die Dampfdüse stets zur Gerätemitte, bevor Sie den Wassertank entnehmen, sonst kann der Tank nicht entnommen werden.

- ✋ Füllen Sie den Wassertank mit frischem kaltem Wasser. Füllen Sie den Tank nie über die MAX-Marke.

- i Füllen Sie nur kaltes Wasser in den Wassertank. Niemals andere Flüssigkeiten wie z.B. Mineralwasser oder Milch einfüllen.

- ✋ Setzen Sie den Wassertank wieder ein (Bild 6). Drücken Sie dabei den Tank fest an, damit sich das Ventil des Wassertanks öffnet.

- i Um immer einen aromatischen Kaffee zu erhalten, sollten Sie:

- das Wasser im Wassertank täglich wechseln,
- den Wassertank mindestens einmal pro Woche in normalem Spülwasser (nicht im Geschirrspüler) reinigen. Anschließend mit Frischwasser nachspülen.

### 5.3 Kaffeebohnenbehälter befüllen

- ✋ Klappen Sie den Deckel des Kaffeebohnenbehälters auf und füllen Sie diesen mit frischen Kaffeebohnen auf (Bild 7). Schließen Sie anschließend den Deckel wieder.

- ⚠ Achtung! Beachten Sie, dass Sie nur reine Bohnen ohne Zusatz von karamellisierten oder aromatisierten Bestandteilen sowie keine gefrorenen

D

Bohnen verwenden Vergewissern Sie sich, dass keine Fremdkörper, wie z.B. Steinchen, in den Bohnenbehälter geraten. **Blockierung oder Beschädigung verursacht durch Fremdkörper im Mahlwerk können von der Garantie ausgeschlossen sein.**

-  Das Mahlwerk ist werkseitig auf einen mittleren Mahlgrad eingestellt. Falls notwendig, können Sie diese Einstellung verändern. Hinweise zum Ändern des Mahlgrads finden Sie unter „Mahlgrad einstellen“ Seite 21.

-  **Der Mahlgrad darf nur während des Mahlvorgangs verändert werden. Einstellungen am stehenden Mahlwerk können die Kaffeemaschine beschädigen.**

-  Die Kaffeemaschine wurde werkseitig geprüft. Hierzu wurde Kaffee benutzt, sodass es vollkommen normal ist, wenn Sie etwas Kaffee im Mahlwerk finden. Es wird auf jeden Fall garantiert, dass diese Kaffeemaschine neu ist.

#### 5.4 Erstes Einschalten

Wenn Sie das Gerät zum ersten Mal in Betrieb nehmen, muss die Kaffeemaschine entlüftet werden.

-  Schalten Sie das Gerät am Hauptschalter an der Geräterückseite ein (Bild 8). Wird der Hauptschalter das allererste mal eingeschaltet, leuchten alle Symbole im Display für ein paar Sekunden für einen Selbsttest, danach blinken die Symbole ☰ und △.
-  Wassertank auffüllen, siehe „Wasser einfüllen“ Seite 13.
-  Setzen Sie den Wassertank wieder ein (Bild 6). Drücken Sie dabei den Tank fest an, damit sich das Ventil des Wassertanks öffnet.
-  Drehen Sie die Dampfdüse nach aussen und stellen Sie eine Tasse darunter (Bild 9).
-  Drehknopf für Dampf und Heisswasser so weit wie möglich gegen den Uhrzeigersinn auf die Stellung ☉☰ drehen (Bild 10).

Etwas Wasser läuft aus der Dampfdüse. Die Symbole ☰ und △ leuchten dauernd.

Wenn die Tasse mit etwa 30 ml Wasser gefüllt ist, fangen die Symbole ☰ und △ an zu blinken.

-  Drehknopf für Dampf und Heisswasser so weit wie möglich im Uhrzeigersinn auf die Stellung ● drehen (Bild 10) um den Wasserausfluss abzustellen.

Das Symbol ☷ blinkt für einige Sekunden und das Gerät schaltet sich aus.

-  Den Kaffeebohnenbehälter mit Kaffeebohnen füllen, siehe „Kaffeebohnenbehälter befüllen“ Seite 13.

#### 5.5 Gerät einschalten

Vergewissern Sie sich vor jedem Einschalten, ob sich Wasser im Wassertank befindet und füllen Sie gegebenenfalls auf. Das Gerät benötigt bei jedem Einschalt- bzw. Ausschaltvorgang Wasser für die automatischen Spülvorgänge.

-  Schalten Sie das Gerät mit der Taste „Ein/Aus“ Ⓛ ein (Bild 11).

-  Unmittelbar nach dem Einschalten stellt sich das Gerät ein. Die dadurch entstehenden Geräusche sind völlig normal.

-  Während des Aufheizvorgangs (ca. 120 Sekunden) blinkt das Symbol ☷. Während des Aufheizens führt das Gerät ein automatisches Spülen durch (ein wenig heisses Wasser fließt aus dem Kaffeeauslauf und wird in der Tropfschale aufgefangen).



Nach Beendigung des Aufheizens leuchtet das Symbol ☷ dauernd.

Das Gerät ist nun betriebsbereit. Es leuchten die Symbole gemäß des zuletzt gewählten Kaffeemodus.

#### 5.6 Gerät ausschalten

-  Schalten Sie das Gerät mit der Taste „Ein/Aus“ Ⓛ aus (Bild 11).

Das Symbol ☷ blinkt. Das Gerät führt einen Spülvorgang durch und schaltet sich aus.

-  Wird das Gerät längere Zeit nicht benutzt, schaltet es sich aus Energie-spargründen nach 3 Stunden automa-tisch aus.
-  Wenn Sie das Gerät längere Zeit nicht benutzen, sollten Sie nach dem Aus-schalten mit der Taste „Ein/Aus“ zusätzlich den Hauptschalter an der Geräterückseite ausschalten (Bild 8).

### 5.7 Wasserhärte einstellen

Nach der ersten Inbetriebnahme oder bei Verwendung einer anderen Wasser-qualität sollten Sie das Gerät auf die Wasser-Härtestufe einstellen, die der örtlichen Wasserhärte entspricht. Ver-wenden Sie das beigelegte Teststäb-chen zur Bestimmung der Härtestufe, oder fragen Sie Ihr Wasserwerk nach dem Härtegrad.

#### Ermitteln der Wasser-Härtestufe

-  Tauchen Sie dazu den Teststreifen für ca. 1 Sekunde in kaltes Wasser. Schüt-teln Sie das überschüssige Wasser ab und ermitteln Sie die Härtestufe anhand der rosa gefärbten Felder.

 **Kein oder ein Feld rosa:**  
**Härtestufe 1, weich**  
bis 1,24 mmol/l, bzw.  
bis 7° deutscher Härte, bzw.  
bis 12,6° französischer Härte

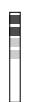

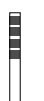

 **Zwei Felder rosa:**  
**Härtestufe 2, mittelhart**  
bis 2,5 mmol/l, bzw.  
bis 14° deutscher Härte, bzw.  
bis 25,2° französischer Härte

 **Drei Felder rosa:**  
**Härtestufe 3, hart**  
bis 3,7 mmol/l, bzw.  
bis 21° deutscher Härte, bzw.  
bis 37,8° französischer Härte

 **Vier Felder rosa:**  
**Härtestufe 4, sehr hart**  
über 3,7 mmol/l, bzw.  
über 21° deutscher Härte, bzw.  
über 37,8° französischer Härte

#### Einstellen und Speichern der ermit-telten Wasser-Härtestufe

Sie können 4 Härtestufen einstellen. Das Gerät ist werkseitig auf Härtestufe 4 eingestellt.

Drücken Sie bei eingeschaltetem Gerät die Taste "P" (Bild 4). Die Symbole "P" und  leuchten. Ausserdem leuchten die 3 kleinen Symbole über den Tasten ,  und , um die momentane Funktion dieser Tasten anzuzeigen, siehe „Spezial-Modus“ Seite 13.

-  Bestätigen Sie die Auswahl mit der Taste "OK" (Bild 5).

Das Display zeigt die augenblickliche Einstellung an. Die Härtestufen werden wie folgt angezeigt:

 Härtestufe 1  
 Härtestufe 2  
 Härtestufe 3  
 Härtestufe 4

-  Drücken sie anschließend die Tasten Blättern "<" oder ">" (Bild 5) so oft, bis die ermittelte Härtestufe angezeigt wird.

-  Bestätigen Sie die Auswahl mit der Taste "OK" (Bild 5). Diese Härtestufe ist nun gespeichert.

-  Um abzubrechen ohne zu speichern, "P" anstatt "OK" drücken.  
Wird „OK“ nicht gedrückt, kehrt das Gerät nach ca. 120 Sekunden automa-tisch in den Kaffeemodus zurück, ohne die Eingaben zu speichern.

-  Um in den Kaffeemodus zurückzukeh-ren, drücken Sie abschließend die Taste "P" (Bild 4) oder warten Sie ca. 120 Sek., bis das Gerät automatisch in den Kaffeemodus zurückspringt.

D

## 6 Kaffee mit Bohnen zubereiten

Der folgende Prozess läuft bei der Kaffeezubereitung mit Bohnen **vollautomatisch** ab: Mahlen, Portionieren, Pressen, Vorbrühen, Brühen und Auswerfen des aufgebrihten Kaffeemehls. Durch die Möglichkeit der Mahlgrad- und Mahlmengeneinstellung können Sie das Gerät individuell auf Ihren persönlichen Geschmack einstellen



Beachten Sie, dass Sie nur reine Bohnen ohne Zusatz von karamellisierten oder aromatisierten Bestandteilen sowie keine gefrorenen Bohnen verwenden. Vergewissern Sie sich, dass keine Fremdkörper, wie z.B. Steinchen, in den Bohnenbehälter geraten. **Blockierung oder Beschädigung verursacht durch Fremdkörper im Mahlwerk können von der Garantie ausgeschlossen sein.**





Wählen Sie je nach Geschmack einen „kurzen“ Espresso oder einen „langen“ Kaffee mit Crema.



Wählen Sie die gewünschte Tassengröße mit dem Drehknopf „Tassengröße“ (Bild 12). Die gewählte Tassengröße wird angezeigt.



Die Tassengrößen werden wie folgt angezeigt:

-  Espressotasse
-  kleine Tasse
-  mittlere Tasse
-  grosse Tasse
-  Becher



Sie können ihren Kaffee mit extramildem, mildem, normalem, starkem oder extrastarkem Aroma wählen.



Wählen Sie die gewünschte Kaffeestärke mit dem Drehknopf „Kaffeestärke“ (Bild 13). Die gewählte Kaffeestärke wird angezeigt.



Die Kaffeestärke wird wie folgt angezeigt:

-  extramild
-  mild

 normal





 stark



 extrastark





Stellen Sie eine oder zwei Tassen unter den Kaffeeauslauf (Bild 14). Durch Hoch- oder Runterschieben des Auslaufes können Sie die Auslaufhöhe optimal Ihrer Tassenhöhe anpassen, um Wärmeverlust und Kaffeespritzer zu reduzieren (Bild 15).





Drücken Sie die Taste "1 Tasse Kaffee"  um eine Tasse zuzubereiten, oder die Taste „2 Tassen“  für 2 Tassen. Das Symbol "1 Tasse"  oder "2 Tassen"  leuchtet. Das Gerät mahlt nun die Bohnen. Bei der Kaffeezubereitung wird das Kaffeepulver zum Vorbrühen zunächst mit einer kleinen Menge Wasser benetzt. Nach einer kurzen Unterbrechung erfolgt der eigentliche Brühvorgang. Der Kaffee wird in die Tasse ausgegeben.

Wenn die gewünschte Menge Kaffee ausgegeben ist, beendet das Gerät automatisch die Ausgabe und wirft das verbrauchte Kaffeepulver in den Tresterbehälter aus. Während dieser Zeit blinkt das Symbol "1 Tasse"  bzw. "2 Tassen" .









Sie können jederzeit die Kaffeeausgabe vorzeitig beenden, indem Sie die Taste "1 Tasse"  oder "2 Tassen"  kurz drücken, oder indem Sie den Drehknopf „Tassengröße“ (Bild 12) gegen den Uhrzeigersinn in Richtung „Espressotasse“ drehen.



Sobald die Kaffeeausgabe beendet ist, können Sie die Kaffeemenge vergrößern indem Sie die Taste „1 Tasse“  oder "2 Tassen"  drücken und halten, bis die gewünschte Kaffeemenge erreicht ist, oder indem Sie den Drehknopf „Tassengröße“ (Bild 12) im Uhrzeigersinn in Richtung „Becher“ drehen (dies muss geschehen, unmittelbar nachdem der Kaffee ausgegeben ist und vor das verbrauchte Kaffeepulver in den Tresterbehälter ausgeworfen wird).



Nach ein paar Sekunden, wenn das Symbol "1 Tasse" ☐ oder "2 Tassen" ☐ erlischt, ist das Gerät wieder betriebsbereit und Sie können den nächsten Kaffee zubereiten.



-  Wenn der Kaffee tröpfchenweise oder nicht ganz austritt, oder der Kaffee zu schnell austritt und die Crema nicht nach Ihrem Geschmack ausgefallen ist, sollten Sie die Mahlgradeinstellung verändern, siehe „Mahlgrad einstellen“ Seite 21
-  Wenn die Symbole ☐ und ☐ blinken, ist das Kaffeepulver zu fein gemahlen. Sie sollten die Mahlgradeinstellung verändern, siehe „Mahlgrad einstellen“ Seite 21.
-  Wenn das Symbol ☐ leuchtet, müssen Sie den Wassertank auffüllen, da das Gerät sonst keinen Kaffee zubereiten kann. (Es ist normal, dass noch etwas Wasser in dem Wassertank ist, wenn das Symbol angezeigt wird.)
-  Wenn das Symbol ☐ leuchtet, ist der Tresterbehälter voll und muss geleert sowie gereinigt werden, siehe „Tresterbehälter leeren“ Seite 23. Solange der Tresterbehälter nicht gereinigt wird, leuchtet das Symbol, und die Kaffeemaschine kann keinen Kaffee zubereiten.
-  Während der Kaffeeausgabe niemals den Wassertank herausnehmen. Falls dieser herausgenommen wurde, kann die Kaffeemaschine keinen Kaffee mehr zubereiten. Zum Entlüften der Kaffeemaschine drehen Sie bitte den Drehknopf für Dampf und Heisswasser so weit wie möglich gegen den Uhrzeigersinn auf die Stellung ☐, ☐, und lassen Sie einige Sekunden lang Wasser aus der Dampfduße laufen.
-  Bei der ersten Inbetriebnahme der Kaffeemaschine sollten Sie mindestens 4-5 Kaffees zubereiten, bevor die Maschine ein zufrieden stellendes Resultat erbringt.

## 6.1 Tipps für die Ausgabe eines heißeren Kaffees:

- Wenn Sie sofort nach Einschalten der Kaffeemaschine die Kaffeemenge für eine kleine Tasse zubereiten möchten (unter 60 ml), verwenden Sie das heiße Wasser des Spülvorgangs zum Vorwärmen der Tassen.
- Stellen Sie eine höhere Kaffeetemperatur ein, siehe „Kaffeetemperatur einstellen“ Seite 22.
- Verwenden Sie keine zu dicke Tassen, außer wenn diese vorgewärmt werden, da sie die Wärme zu sehr absorbieren.
- Verwenden Sie vorgewärmte Tassen, indem Sie diese mit warmem Wasser ausspülen oder sie mindestens 20 Minuten auf die beheizte Tassenablage (H) der eingeschalteten Kaffeemaschine stellen.

## 7 Mehrere Tassen Kaffee mit der Kannen-Funktion zubereiten

Mit dieser Funktion können Sie vollautomatisch mehrere Tassen Kaffee direkt in die mitgelieferte Edelstahl-Warmhaltekanne zubereiten: Mahlen, Portionieren, Pressen, Vorbrühen, Brühen und Auswerfen des aufgebrihten Kaffeemehls wie im vorhergehenden Abschnitt beschrieben.

-  Drehen Sie den Deckel der mitgelieferten Edelstahl-Warmhaltekanne in die Position zum Abnehmen (Bild 16) und nehmen Sie den Deckel ab. Spülen Sie die Kanne und den Deckel.
-  Setzen Sie den Deckel in der Stellung zum Ausschütten (Bild 17) auf die Warmhaltekanne und stellen Sie diese unter den Kaffeeauslauf (D). Der Kaffeeauslauf muss ganz nach oben geschoben sein, damit die Warmhaltekanne eingeschoben werden kann. Eines der Symbole für die Kannen-Funktion leuchtet, je nachdem, wie-

D

viele Tassen bei der letzten Benutzung der Kannen-Funktion gewählt waren. Ausserdem leuchten die Symbole Blättern "<" und ">".

Die Anzahl der Tassen, die in die Kanne ausgegeben werden, wird wie folgt angezeigt:

 4 Tassen



 6 Tassen



 8 Tassen

 10 Tassen

-  Überzeugen Sie sich davon, dass der Wassertank voll ist, dass genügend Kaffeebohnen im Bohnenbehälter sind und der Tresterbehälter leer ist, um einen Reihe von Kaffees in die Kanne zubereiten zu können.

-  Wenn Sie die Kaffeestärke und die Füllmenge für die Kannen-Funktion ändern wollen, benutzen Sie den Drehknopf „Tassengrösse“ (Bild 12) bzw. den Drehknopf „Kaffeestärke“ (Bild 13) wie im Abschnitt „Kaffee mit Bohnen zubereiten“ Seite 16, beschrieben.

-  Wählen Sie gegebenenfalls mit den Tasten Blättern "<" oder ">" das Symbol entsprechend der Anzahl Tassen, die in die Kanne zubereitet werden sollen, z.B.  für 8 Tassen.

-  Drücken Sie die Taste „Kanne“  (Bild 18).



Während der Kaffeezubereitung blinkt das Kannen-Symbol für die gewählte Anzahl Tassen.

Wenn der Brühvorgang beendet ist, blinken alle Kannen-Symbole abwechselnd, wobei das Symbol für die gewählte Anzahl Tassen doppelt so lange leuchtet wie die anderen Symbole.

-  Entnehmen Sie nun die Warmhaltekanne und schliessen Sie den Deckel (Bild 19), um den Kaffee für lange Zeit warm zu halten.

Das Gerät kehrt automatisch in den Kaffee-Modus zurück.





-  Sind entweder zu wenig Kaffeebohnen eingefüllt oder ist zu wenig Wasser im Wassertank, um die gewünschte Funktion zu Ende zu führen, oder ist der Tresterbehälter voll, unterbricht das Gerät den Vorgang und das laufende Programm wird abgebrochen. Nachdem der Fehler behoben ist, muss das Programm neu gestartet werden. Dabei muss die Menge Kaffee, die sich bereits in der Kanne befindet, berücksichtigt werden, damit die Kanne nicht überfüllt wird.

-  Wenn die Symbole  und  blinken, ist das Kaffeepulver zu fein gemahlen. Sie sollten die Mahlgradeinstellung verändern, siehe „Mahlgrad einstellen“ Seite 21.

## 8 Kaffee mit Pulver zubereiten

Mit dieser Funktion können Sie bereits gemahlene Kaffee, z.B. **entkoffeinierten Kaffee**, aufbrühen.

-  Achtung! Vergewissern Sie sich, dass kein Pulver im Schacht hängengeblieben ist, ebenso dürfen keine Fremdkörper in den Schacht gelangen. Der Einfüllschacht ist kein Vorratsbehälter, das Pulver muss direkt zur Brüheinheit gelangen.

-  Drehen Sie den Drehknopf "Kaffeestärke / vorgemahlener Kaffee" (Bild 20) in die gewünschte Position  (für 1 Tasse) oder  (für 2 Tassen), um die Funktion für vorgemahlene Kaffeepulver zu wählen. Dadurch wird die Kaffeemühle außer Betrieb gesetzt. Ein Symbol  (für 1 Tasse) oder beide Symbole  (für 2 Tassen) leuchten.

-  Öffnen Sie den Deckel des Kaffeepulverschachtes und füllen Sie das frische Kaffeepulver ein (Bild 21).

Benutzen Sie nur den mitgelieferten Messlöffel. Füllen Sie nie mehr als 2 gestrichene Messlöffel ein, sonst bereitet entweder das Gerät keinen Kaffee

zu, das Kaffeepulver wird im Gerät verteilt und verschmutzt dieses, oder der Kaffee wird tröpfchenweise ausgegeben und die Symbole ☞ und ▲ blinken.

Füllen Sie während des Brühvorgangs kein Kaffeepulver ein. Erst nach Beenden des kompletten Brühvorgangs, wenn das Gerät wieder bereit ist, das Kaffeepulver für die nächste Tasse einfüllen. Füllen Sie nie Pulver bei ausgeschalteter Maschine ein, da dieses sonst im Innern des Gerätes verteilt wird.

 Benutzen Sie nur Kaffeepulver für vollautomatische Espressomaschinen. Keine Kaffeebohnen, keine wasserlöslichen, gefriergetrockneten Instantprodukte sowie keine anderen Getränkepulver in den Schacht einfüllen. Zu feine Kaffeepulver können zu Verstopfungen führen.

 Ist der Einfüllschacht verstopft (auf Grund von Feuchtigkeit im Gerät, oder weil mehr als 2 Messlöffel Kaffeepulver eingefüllt wurden) benutzen Sie ein Messer oder einen Löffelstiel um das Pulver nach unten zu schieben (Bild 22). Dann die Brüheinheit entnehmen und zusammen mit der Kaffeemaschine wie unter „Brüheinheit reinigen“ Seite 23 beschrieben reinigen.

 Schließen Sie den Deckel.

 Wählen Sie die gewünschte Tassen-grösse mit dem Drehknopf „Tassen-grösse“ (Bild 12) wie im Abschnitt „Kaffee mit Bohnen zubereiten“ Seite 16 beschrieben.

 Drücken Sie die Taste "1 Tasse Kaffee" ☐ um eine Tasse zuzubereiten, oder die Taste „2 Tassen“ ☐ für 2 Tassen. Der Kaffee wird zubereitet.

 Wurde die Funktion für vorgemahlene Kaffeepulver für 1 Tasse gewählt und kein Kaffeepulver in den Kaffeepulverschacht eingefüllt, blinken nach Drücken der ☐ Taste die Symbole ☞ und ▲. Wurde die Funktion für vorge-

mahlene Kaffeepulver für 2 Tassen gewählt und kein Kaffeepulver in den Kaffeepulverschacht eingefüllt, blinken nach Drücken der ☐ Taste die Symbole ☞ ☞ und ▲.

 Um nach der Zubereitung des Kaffees wieder in den Modus für Kaffeebohnen zurückzukehren, drehen Sie den Drehknopf "Kaffeestärke / vorgemahlener Kaffee" (Bild 20) auf eine beliebige Kaffeestärkeneinstellung (der Betrieb der Kaffeemühle wird wieder ermöglicht).

## 9 Milch aufschäumen

Der Dampf kann zum Aufschäumen von Milch und zum Erhitzen von Flüssigkeiten benutzt werden. Da zur Dampferzeugung eine höhere Temperatur benötigt wird als zur Kaffe Zubereitung, verfügt das Gerät über einen zusätzlichen Dampfmodus.

 Für eine Portion Cappuccino füllen Sie eine große Tasse zu 1/2 bis 2/3 mit Espresso und geben anschließend die aufgeschäumte Milch dazu.

 Achtung! Verbrühungsgefahr bei aktivierter Dampfdüse! Austretendes Heißwasser bzw. heißer Wasserdampf kann zu Verbrühungen führen. Aktivieren Sie die Dampfdüse deshalb erst, wenn diese in die Milch eingetaucht ist.

 Zur Dampfvorbereitung drücken Sie die Taste "Dampf" ☐ (Bild 23).

Das Symbol ☐ leuchtet und das Gerät heizt auf. Während dem Aufheizen blinkt das Symbol ☐.

Nach Beendigung des Aufheizvorganges leuchtet das Symbol ☐ permanent. Das Gerät ist für das Milchaufschäumen vorbereitet.

 Wird die Dampffunktion länger als 2 Minuten nicht benutzt, schaltet das Gerät automatisch in den Kaffeemodus zurück.





D

- i** Um zu vermeiden, dass sich beim Aufschäumen Restwasser mit in die Milch mischt, sollten Sie das Wasser vorher ablassen. Halten sie hierzu ein Gefäß unter die Dampfdüse und drehen Sie den Drehknopf für Dampf und Heisswasser (Bild 10) so lange in die Position ☺ ☺ bis sich Dampf einstellt. Drehen Sie den Drehwähler dann auf die Position ● zurück.
- ☞** Gießen Sie fettarme, kalte Milch in einen Becher, der unter die Dampfdüse des Gerätes passen muss.
- i** Die Milch sollte gut gekühlt sein. Ebenfalls sollten Sie ein kaltes Gefäß, am Besten einen Edelstahlbecher, benutzen und dieses nicht vorher mit warmem Wasser ausspülen.
- ☞** Schwenken Sie die Dampfdüse nach aussen und halten Sie den Becher so unter die Dampfdüse, dass die Düsenöffnung so eben in die Milch eintaucht (Bild 24).
- !** **Achtung!** Gefahr von Verunreinigungen durch angetrocknete Milch in der Dampfdüse. Achten Sie darauf, dass Sie die Dampfdüse nicht so weit in die Milch eintauchen, dass die Luftansaugöffnung am oberen Ende der Dampfdüse mit Milch bedeckt ist. Hierdurch kann Milch in die Düse gesaugt werden und evtl. Verunreinigungen der Dampfdüse verursachen.
- ☞** Drehen Sie den Drehknopf für Dampf und Heisswasser (Bild 10) in die Pos. ☺ ☺. Die Milch wird aufgeschäumt.
- i** Um einen cremigeren Milchschaum zu erhalten, das Gefäß langsam von unten nach oben bewegen. Schäumen Sie die Milch mindestens bis zum doppelten Volumen auf.
- i** Es wird empfohlen, nicht länger als 2 Minuten ohne Unterbrechung Dampf zu beziehen.
- ☞** Um das Aufschäumen zu beenden, drehen Sie den Drehknopf für Dampf und Heißwasser (Bild 10) auf die Pos. ● und entfernen anschließend das Gefäß.
- !** **Achtung!** Verbrühungsgefahr durch herausstritzende, heiße Milch! Schalten Sie den Dampf ab, bevor Sie das Gefäß mit der aufgeschäumten Milch herausziehen.
- ☞** Verlassen Sie den Dampfmodus, indem Sie die Taste "Dampf" ☺ ☺ (Bild 23) drücken oder warten Sie ca. 120 Sek., bis das Gerät automatisch in den Kaffeemodus zurückkehrt.
- Das Gerät ist nun wieder für die Kaffeezubereitung bereit.
- ☞** Lassen Sie in jedem Fall nach dem Aufschäumen von Milch noch einmal kurz heißes Wasser durch die Düse austreten, indem Sie den Drehknopf für Dampf und Heißwasser (Bild 10) in die Position ☺ ☺ drehen.
- Dies ist notwendig, damit die Milchreste innerhalb der Düse nicht antrocknen können und somit die Düse verstopfen. Verwenden Sie hierfür ein geeignetes Auffanggefäß. Während dieses Vorgangs leuchtet das Symbol ☺ ☺.
- ☞** Stellen Sie anschließend den Drehknopf für Dampf und Heißwasser wieder auf die Pos. ●, im Display erscheint die zuletzt gewählte Kaffeeinstellung.

### 9.1 Dampfdüse reinigen









**Wichtig:** Aus hygienischen Gründen wird empfohlen, den im Folgenden beschriebenen Vorgang jedes Mal durchzuführen, nachdem Sie Milch aufgeschäumt haben. Sie vermeiden damit, dass sich Milch im Innern der Dampfdüse absetzt.

- ☞** Drehen Sie den Drehknopf für Dampf und Heißwasser im Uhrzeigersinn bis zum Anschlag auf die Pos. ●. Warten Sie ein paar Minuten, bis sich die Dampfdüse abgekühlt hat.
- ☞** Fassen Sie dann das Schwenkrohr am schwarzen Griff und öffnen Sie den Bajonettverschluss der Dampfdüse durch eine kleine Drehung im Uhrzeigersinn. Ziehen Sie die Dampfdüse nach unten ab (Bild 25).

-  Ziehen Sie den inneren Teil der Dampfdüse nach unten vom Schwenkrohr ab.
-  Reinigen Sie die Dampfdüse und den inneren Teil mit warmem Wasser.
-  Kontrollieren Sie, dass die beiden in Abb. 26 markierten Löcher nicht verstopft sind. Gegebenenfalls mit einer Nadel durchstechen und säubern.
-  Montieren Sie den inneren Teil wieder, indem Sie ihn vorsichtig auf das Schwenkrohr schieben.
-  Montieren Sie die Dampfdüse wieder, indem Sie wieder aufschieben und gegen den Uhrzeigersinn drehen.

## 10 Heisswasserzubereitung

Das Heißwasser kann zum Vorwärmen von Tassen und zum Zubereiten von Heißgetränken, wie z. B. Tee oder Fertigsuppen benutzt werden.

-  **Achtung!** Verbrühungsgefahr bei aktivierter Heißwasserdüse! Austretendes Heißwasser kann zu Verbrühungen führen. Aktivieren Sie die Heißwasserdüse nur, wenn sich ein Behältnis unter die Heißwasserdüse befindet.
-  Stellen Sie ein Gefäß unter die Heißwasserdüse.
-  Drehen Sie den Drehknopf für Dampf und Heißwasser in die Position  (Bild 10). Heißes Wasser wird ausgegeben; das Symbol  leuchtet.
-  Es wird empfohlen, nicht länger als 2 Minuten ohne Unterbrechung Heißes Wasser zu beziehen.
-  Nach der Heißwasserentnahme drehen Sie den Drehknopf für Dampf und Heißwasser in die Position  zurück (Bild 10) und entfernen Sie das Gefäß.

## 11 Mahlgrad einstellen



Das Mahlwerk ist werkseitig auf einen mittleren Mahlgrad eingestellt. Sollte die Kaffeeausgabe entweder zu schnell oder zu langsam (tröpfchenweise) sein, können Sie den Mahlgrad während des Mahlvorgangs verändern.



**Der Mahlgrad darf nur während des Mahlvorgangs verändert werden, d.h. der Knopf für die Mahlgradeinstellung (Bild 2, T und Bild 27) darf nur gedreht werden, solange das Mahlwerk während einer Kaffeezubereitung Kaffeebohnen mahlt. Einstellungen am stehenden Mahlwerk können die Kaffeemaschine beschädigen.**



Stellen Sie den Mahlgrad mit dem Knopf für die Mahlgradeinstellung (Bild 2, T) ein (Bild 27).

- Wenn der Kaffee tröpfchenweise oder nicht ganz austritt (möglicherweise blinken die Symbole  und , muss der Knopf um eine Position im Uhrzeigersinn gedreht werden. Drehen Sie jeweils um eine Position, bis eine zufrieden stellende Kaffeeausgabe erreicht wird.
- Falls der Kaffee zu schnell heraustritt und die Crema nicht nach Ihrem Geschmack ausgefallen ist, drehen Sie den Knopf um eine Position gegen den Uhrzeigersinn.



Achten Sie darauf, den Knopf für die Mahlgradeinstellung nicht zu weit zu drehen, da sonst bei dem Bezug von 2 Tassen der Kaffee eventuell tröpfchenweise austritt.



Die Wirkung dieser Korrekturen merken Sie jedoch erst nach mindestens 2 darauf folgenden Kaffeezubereitungen.

### **Fremdkörper im Mahlwerk entfernen**

Fremdkörper im Mahlwerk wie z.B. Steinchen können das Mahlwerk beschädigen. Ein Fremdkörper im Kaffee verursacht ein gleichmäßiges lautes Rattern. Sollten Sie während des Mahl-

D

vorgangs dieses Geräusch hören, schalten Sie das Gerät unverzüglich aus und wenden Sie sich an den Kundendienst. **Blockierung oder Beschädigung verursacht durch Fremdkörper im Mahlwerk können von der Garantie ausgeschlossen sein.**

## 12 Kaffeetemperatur einstellen

Sie können zwischen drei Temperaturstufen wählen. Die Werkseinstellung ist «Temperatur hoch». Sie können diese wie folgt ändern:

- ☞ Drücken Sie die Taste "P" (Bild 4).

Die Symbole "P" und ☞ leuchten. Ausserdem leuchten die 3 kleinen Symbole über den Tasten ☞, ☞ und ☞, um die momentane Funktion dieser Tasten anzuzeigen, siehe „Spezial-Modus“ Seite 13.

- ☞ Drücken Sie die Tasten Blättern "<" oder ">" (Bild 5) so oft, bis das Symbol ☞ leuchtet.

- ☞ Bestätigen Sie mit der Taste "OK" (Bild 5).

Das Display zeigt die augenblickliche Einstellung an. Die Temperaturen werden wie folgt angezeigt:

- ☞ Temperatur niedrig
- ☞☞ Temperatur mittel
- ☞☞☞ Temperatur hoch

- ☞ Wählen Sie gegebenenfalls mit den Tasten Blättern "<" oder ">" (Bild 5) eine andere Temperatur.

- ☞ Wenn die gewünschte Temperatur angezeigt wird, bestätigen Sie diese mit der Taste "OK" (Bild 5). Diese Temperatur ist hiermit programmiert.

- i** Um abzubrechen ohne zu speichern, "P" anstatt "OK" drücken.

- i** Wird „OK“ nicht gedrückt, kehrt das Gerät nach ca. 120 Sekunden automatisch in den Kaffeemodus zurück, ohne die Eingaben zu speichern.

- ☞ Um in den Kaffeemodus zurückzukehren, drücken Sie abschließend die Taste "P" (Bild 4) oder warten Sie ca. 120 Sek., bis das Gerät automatisch in den Kaffeemodus zurückspringt.

## 13 Reinigung und Pflege

Halten Sie Ihr Gerät stets sauber für konstante Kaffequalität und störungsfreie Funktion.

### 13.1 Regelmäßige Reinigung

- !** **Achtung!** Schalten Sie vor der Reinigung das Gerät aus. Lassen Sie das Gerät abkühlen.

- !** **Achtung!** Geben Sie das Gerät oder einzelne Teile des Gerätes niemals in die Geschirrspülmaschine. Tauchen Sie die Kaffeemaschine niemals ins Wasser.

- !** **Achtung!** Niemals Wasser in den Bohnenbehälter geben, dadurch wird das Mahlwerk beschädigt.

- !** Verwenden Sie keine kratzenden, scheuernden oder ätzenden Mittel. Wischen Sie das Gehäuse innen und aussen nur mit einem feuchten Tuch ab.

- ☞ Entnehmen Sie täglich den Wassertank (Bild 6) und schütten Sie das Restwasser weg. Spülen Sie den Wassertank mit frischem Wasser aus. Verwenden Sie täglich frisches Wasser.

- ☞ Leeren Sie den Tresterbehälter täglich oder spätestens, wenn Sie durch das Display dazu aufgefordert werden, siehe „Tresterbehälter leeren“ Seite 23.

- ☞ Entleeren Sie die Tropfschale regelmäßig. Spätestens jedoch dann, wenn der rote Schwimmer der Tropfschale (Bild 28) durch die Öffnung im Tropfgitter erscheint.

- ☞ Reinigen Sie regelmässig, mindestens einmal pro Woche, Wassertank (N), Tropfschale (O), Tropfgitter (A) und Tresterbehälter(Q) mit warmem Wasser, mildem Spülmittel und evtl. einem Pinsel.

- ☞ Nehmen Sie nach jedem Aufschäumen die Dampfdüse ab und reinigen Sie diese gründlich von Milchrückständen, siehe „Dampfdüse reinigen“ Seite 20.
- ☞ Überprüfen Sie, dass die Öffnungen des Kaffeeauslaufs nicht verstopft sind. Zum Säubern können Sie mit einer Nadel den angetrockneten Kaffee entfernen (Bild 29).

### 13.2 Tresterbehälter leeren

Das Gerät zählt die Anzahl der zubereiteten Kaffees. Nach 14 einzeln (oder 7 paarweise) zubereiteten Kaffees leuchtet das Symbol ☒, um darauf hinzuweisen, dass der Tresterbehälter voll ist und entleert sowie gereinigt werden muss. Solange der Tresterbehälter nicht gereinigt wird, kann die Kaffeemaschine keinen Kaffee zubereiten.

- ☞ Zur Reinigung die Servicetür durch Drücken auf den entsprechenden Öffnungsknopf entriegeln und öffnen (Bild 30), das Symbol ☐ leuchtet.
- ☞ Dann die Abtropfschale entnehmen (Bild 31), entleeren und reinigen.
- ☞ Entleeren und reinigen Sie sorgfältig den Tresterbehälter. Achten Sie bitte darauf, dass alle auf dem Boden abgelagerten Rückstände beseitigt werden.  
**Wichtig:** Jedes Mal, wenn Sie die Abtropfschale herausziehen, muss auch der Tresterbehälter geleert werden, selbst wenn dieser nicht ganz voll ist. Wird dieser Vorgang nicht ausgeführt, kann es bei den darauf folgenden Kaffeezubereitungen passieren, dass sich der Tresterbehälter zu sehr füllt und der übermäßige Kaffeesatz die Kaffeemaschine verstopft.

- i** Wenn Sie die Abtropfschale entnommen haben, blinkt das Symbol ☒.
- i** Leeren Sie grundsätzlich bei täglichem Gebrauch des Gerätes auch den Behälter täglich.  
Entleeren Sie den Tresterbehälter immer bei eingeschaltetem Gerät. Nur dann erkennt das Gerät die Entleerung.

### 13.3 Mahlwerk reinigen

Kaffeemehlrückstände können mit einem weichen Pinsel oder einem Staubsauger aus dem Bohnenbehälter entfernt werden.

- ⚠ Achtung! Niemals Wasser in das Mahlwerk geben, dadurch wird das Mahlwerk beschädigt.

- ☞ Schalten Sie das Gerät mit der Taste Ein/Aus (Bild 11) und dem Hauptschalter (Bild 8) aus. Ziehen Sie den Netzstecker.
- ☞ Entfernen Sie die restlichen Kaffeebohnen (z.B. Staubsauger mit Schlauch oder Fugendüse verwenden).

- i** Lässt sich ein Fremdkörper nicht entfernen, wenden Sie sich an den Kundendienst. **Blockierung oder Beschädigung verursacht durch Fremdkörper im Mahlwerk können von der Garantie ausgeschlossen sein.**

- ⚠ Achtung! Verletzungsgefahr durch drehendes Mahlwerk. Schalten Sie niemals das Gerät ein, wenn Sie am Mahlwerk arbeiten. Dies kann schwerste Verletzungen verursachen. Ziehen Sie unbedingt den Netzstecker.

- ☞ Testen Sie nun mit einer geringen Menge Bohnen die Funktion des Mahlwerks, indem Sie einen Kaffee zubereiten. Bei der ersten Mahlung oder nach der Reinigung wird weniger Kaffeemehl in die Brüheinheit gelangen, da der Kanal gefüllt werden muss. Dies kann den ersten Kaffee beeinflussen.

### 13.4 Brüheinheit reinigen

Wir empfehlen, die Brüheinheit (je nach Nutzungsintensität) regelmäßig zu reinigen. Bevor Sie Ihr Gerät längere Zeit nicht benutzen (z.B. Urlaub), ist es notwendig den Tresterbehälter und den Wassertank zu entleeren und das Gerät inkl. Brüheinheit gründlich zu reinigen. Gehen Sie wie folgt vor:

- ☞ Durch Drücken der Taste Ein/Aus aus (Bild 11) die Kaffeemaschine ausschalten (nicht den Netzstecker ziehen) und abwarten, bis alle Symbole erlöschen!

D















-  Die Servicetür durch Drücken auf den entsprechenden Öffnungsknopf entriegeln und öffnen (Bild 30).
-  Die Abtropfschale und den Tresterbehälter entnehmen (Bild 31) und reinigen.
-  Die beiden roten Entriegelungstasten der Brüheinheit seitlich und gegen die Mitte andrücken (Bild 32) und die Brüheinheit herausziehen.
-  **Achtung:** Die Brüheinheit kann nur herausgenommen werden, wenn das Gerät mit der Taste Ein/Aus  an der Gerätevorderseite ausgeschaltet ist. Das Gerät soll nicht vom Stromnetz getrennt werden. Falls Sie versuchen sollten, die Brüheinheit bei eingeschalteter Kaffeemaschine herauszunehmen, könnte diese ernsthaft beschädigt werden.
-  Die Brüheinheit ohne Benutzung von Spülmitteln unter fließendem Leitungswasser reinigen. Die Brüheinheit niemals im Geschirrspüler reinigen.
-  Das Maschineninnere sorgfältig reinigen. Die Kaffeeverkrustungen in der Kaffeemaschine mit einer Holz- oder Plastikgabel oder etwas Ähnlichem, was die Oberfläche nicht zerkratzt, abkratzen (Bild 33) und dann mit einem Staubsauger alle Rückstände absaugen (Bild 34).
-  Zum Wiedereinsetzen die Brüheinheit (Bild 36, a) in den Halter (Bild 36, b) und den Stift (Bild 36, c) einschieben. Der Stift muss in das Rohr (Bild 36, d) unten an der Brüheinheit eingeführt werden.
-  Nun fest auf die Schrift PUSH (Bild 36, e) drücken, bis die Brüheinheit hörbar einrastet.
-  Versichern Sie sich, nachdem Sie das Klicken des Einrastens gehört haben, dass die roten Tasten (Bild 36, f) herausgeschnappt sind, andernfalls kann die Servicetür nicht geschlossen werden.

Bild 37: Die beiden roten Tasten sind korrekt herausgeschnappt.

Bild 38: Die beiden roten Tasten sind nicht herausgeschnappt.

-  Setzen Sie die Abtropfschale zusammen mit dem Tresterbehälter wieder ein.
-  Schliessen Sie die Servicetür.
-  Wenn die Brüheinheit nicht korrekt eingesetzt ist, d.h. bis ein Klicken durch das Einrasten hörbar ist, und die roten Tasten nicht richtig herausgeschnappt sind, kann die Serviceklappe nicht geschlossen werden.

-  Wenn die Brüheinheit sich nur schwer einsetzen lässt, muss diese (vor dem Einsetzen) auf die richtige Höhe gebracht werden, und zwar indem die Brüheinheit gleichzeitig von unten und von oben, wie in Abbildung 35 dargestellt, fest zusammengedrückt wird.

-  Wenn sich die Brüheinheit noch immer schwer einsetzen lässt, schließen Sie die Servicetür, ziehen Sie den Stecker des Versorgungskabels aus der Steckdose und stecken Sie ihn wieder ein. Warten Sie ab, bis alle Symbole erlöschen, öffnen Sie dann die Servicetür und setzen Sie die Brüheinheit wieder ein.

### 13.5 Entkalkungsprogramm durchführen

Das Entkalkungsprogramm ermöglicht eine einfache und wirksame Entkalkung Ihres Gerätes. Wenn Sie durch das leuchtende Symbol  darauf hingewiesen werden, muss das Gerät entkalkt werden.

-  **Achtung:** Auf keinen Fall irgendwelche Entkalkungsmittel verwenden, die nicht von AEG/Electrolux empfohlen sind. Bei Verwendung anderer Entkalkungsmittel übernimmt AEG/Electrolux keine Haftung für evtl. Schäden. Entkalkungsflüssigkeit erhalten Sie im Fachhandel oder unter der AEG/Electrolux Serviceline.



- i** Der Entkalkungsprozess dauert ca. 45 Minuten und sollte nicht unterbrochen werden. Bei Stromausfall muss das Programm neu gestartet werden.
- ☞** Bevor Sie das Entkalkungsprogramm starten, reinigen Sie die Brühinheit (siehe „Brühinheit reinigen“ Seite 23).
- ☞** Drücken Sie die Taste "P" (Bild 4). Die Symbole "P" und ☕ leuchten. Ausserdem leuchten die 3 kleinen Symbole über den Tasten ☐, ☐ und ☐, um die momentane Funktion dieser Tasten anzuzeigen, siehe „Spezial-Modus“ Seite 13.
- ☞** Drücken Sie die Tasten Blättern "<" oder ">" (Bild 5) so oft, bis das Symbol ☐ leuchtet.
- ☞** Bestätigen Sie mit der Taste "OK" (Bild 5). Die Symbole ☐ und ☐ blinken und "P" leuchtet dauernd.
- i** Um das Entkalkungsprogramm an dieser Stelle abzubrechen, das Gerät mit der Taste „Ein/Aus“ ⓪ ausschalten (Bild 11).
- ☞** Den Wassertank leeren, mit mindestens 1 Liter Wasser füllen und das Entkalkungsmittel zugeben.
- ⚠** Achtung: Stellen Sie sicher, dass eventuelle Spritzer des Entkalkungsmittels nicht auf säureempfindliche Oberflächen wie Marmor, Kalkstein und Keramik geraten.
- ☞** Ein Gefäß mit mindestens 1,5 Liter Fassungsvermögen unter die Dampfdüse stellen (Bild 9)
- ☞** Den Drehknopf für Dampf und Heisswasser auf die Position ☕ stellen. Das Entkalkungsprogramm startet und die Entkalkungsflüssigkeit läuft aus der Dampfdüse. Die Symbole ☐, ☐ und "P" leuchten dauernd. Das Entkalkungsprogramm führt automatisch eine Reihe von Spülungen und Pausen durch, um Kalkablagerungen aus dem Innern der Kaffeemaschine zu entfernen.
- Nach ungefähr 30 Minuten ist der Wassertank leer und die Symbole ☕ und ☐ blinken und "P" leuchtet dauernd.
- ☞** Den Drehknopf für Dampf und Heisswasser zurück auf die Position ● stellen. Das Gerät ist nun bereit für einen Spülvorgang mit frischem Wasser. .
- ☞** Den Wassertank herausnehmen, mit frischem Wasser füllen und wieder einsetzen.
- ☞** Das Gefäß unter der Dampfdüse leeren und wieder unter die Dampfdüse stellen.
- ☞** Den Drehknopf für Dampf und Heisswasser auf die Position ☕ stellen. Ein Spülvorgang mit frischem Wasser wird durchgeführt und das Spülwasser läuft aus der Dampfdüse. Die Symbole ☕, ☐ und "P" leuchten dauernd. Nach einigen Minuten ist der Wassertank leer und die Symbole ☕ und ☐ blinken und "P" leuchtet dauernd.
- ☞** Den Drehknopf für Dampf und Heisswasser zurück auf die Position ● stellen. Die Symbole gemäß des zuletzt gewählten Kaffeemodus werden angezeigt, und das Symbol ☕ leuchtet dauernd.
- ☞** Das Gefäß mit dem Spülwasser leeren.
- ☞** Den Wassertank herausnehmen, mit frischem Wasser füllen und wieder einsetzen. Das Gerät ist nun wieder betriebsbereit und im Zustand des zuletzt ausgewählten Kaffeemodus.
- i** Wir empfehlen, nach dem Durchlauf des Entkalkungsprogrammes die erste bezogene Tasse Kaffee wegzugießen.

D

## 14 Bestellung von Zubehör

Damit Sie lange Freude an Ihrem Gerät haben und um vorzeitige Defekte zu vermeiden, ist es sehr wichtig, das Gerät regelmäßig zu reinigen und zu entkalken. Das Original-Entkalkungsmittel können Sie auch direkt bei uns beziehen.



Bitte wenden Sie sich in Deutschland an unsere Bestell-Hotline:

1801 - 20 30 60\*



(\*Ortstarif aus dem Festnetz der Deutschen Telekom)  
montags bis freitags von 8.00 - 18.00 Uhr

## 15 Was ist zu tun, wenn auf dem Display folgende Symbole angezeigt werden...

**Das Symbol  leuchtet dauernd**

- Der Wassertank ist leer oder nicht richtig eingesetzt.
-  Den Wassertank auffüllen und vorschriftsmässig einsetzen, siehe „Wasser einfüllen“ Seite 13.
- Der Wassertank ist schmutzig, oder es haben sich Kalkverkrustungen darin gebildet.
-  Den Wassertank ausspülen oder entkalken.

**Die Symbole  und  blinken**



- Die Kaffeemaschine kann keinen Kaffee zubereiten.
-  Ein Gefäss unter die Dampfdüse stellen und den Drehknopf für Dampf und Heisswasser gegen den Uhrzeigersinn in die Position  drehen (Bild 9).
- Der Kaffee tritt zu langsam heraus.
-  Den Knopf für die Mahlgradeinstellung (Bild 12) um eine Position im Uhrzeigersinn drehen, solange das Mahlwerk während einer Kaffeezubereitung Kaffeebohnen mahlt (siehe „Mahlgrad einstellen“ Seite 21).

**Das Symbol  leuchtet dauernd**







- Der Tresterbehälter ist voll.
-  Den Tresterbehälter wie in „Tresterbehälter leeren“ Seite 23 beschrieben leeren, reinigen und richtig wieder einsetzen.



**Das Symbol  blinkt**

- Der Tresterbehälter wurde nach dem Reinigen nicht wieder eingesetzt.
-  Servicetür öffnen und Tresterbehälter einsetzen.

**Die Symbole  oder  und  blinken**

- Nach Anwahl der Funktion für vorge-mahlten Kaffee wurde kein Kaffeepulver in den Einfüllschacht gegeben.
-  Kaffeepulver einfüllen wie unter „Kaffee mit Pulver zubereiten“ Seite 18 beschrieben.

**Alle Symbole für die Kaffeestärke      und  blinken**

- Es sind keine Kaffeebohnen mehr im Kaffeebohnenbehälter.
-  Kaffeebohnenbehälter auffüllen, siehe „Kaffeebohnenbehälter befüllen“ Seite 13
- Wenn das Mahlwerk sehr laut wird, kann dies bedeuten, dass ein kleines, in den Kaffeebohnen enthaltenes Steinchen das Mahlwerk blockiert hat.
-  Wenden Sie sich an den Kundendienst. **Blockierung oder Beschädigung verursacht durch Fremdkörper im Mahlwerk können von der Garantie ausgeschlossen sein.**



**Das Symbol  leuchtet dauernd**

- Zeigt an, dass die Kaffeemaschine mit Kalk verkrustet ist.
-  Das in Kapitel „Entkalkungsprogramm durchführen“ Seite 24 beschriebene Entkalkungsprogramm muss so schnell wie möglich durchgeführt werden.

**Das Symbol  leuchtet dauernd**

- Die Servicetür ist offen.
-  Die Servicetür nicht schließen lassen, so vergewissern Sie sich, dass die Brüheinheit korrekt eingesetzt ist (siehe „Brüheinheit reinigen“ Seite 23)



**Das Symbol  blinkt**

- Wahrscheinlich wurde vergessen, die Brüheinheit nach erfolgter Reinigung wieder in der Kaffeemaschine einzusetzen.
-  Die Brüheinheit einsetzen, siehe „Brüheinheit reinigen“ Seite 23
- Das Maschineninnere ist sehr verschmutzt.
-  Das Maschineninnere sorgfältig reinigen, siehe „Brüheinheit reinigen“ Seite 23. Wenn nach erfolgter Reinigung die Kaffeemaschine noch immer die Meldung anzeigt, wenden Sie sich bitte an den Kundendienst.

**Das Symbol  leuchtet dauernd**

- Dies zeigt einen generellen Alarm an.
-  Wenden Sie sich bitte an den Kundendienst.

**Die Symbole  und  blinken**

- Das Gerät wurde eingeschaltet mit dem Drehknopf für Dampf und Heisswasser in Stellung „offen“ .
-  Den Drehknopf für Dampf und Heisswasser im Uhrzeigersinn (Bild 10) bis zum Anschlag auf die Position  drehen.

**Die Symbole  und  blinken**

- Die Umgebungstemperatur ist zu niedrig, um das Gerät betreiben zu können.
-  Betreiben Sie das Gerät in einem wärmeren Raum.



**16 Lösbare Probleme, bevor Sie den Kundendienst rufen**

Wenn die Kaffeemaschine nicht funktioniert, können Sie leicht die Ursache der Betriebsstörung ausfindig machen und diese beheben, indem Sie das Kapitel „Was ist zu tun, wenn auf dem Display folgende Symbole angezeigt werden...“ Seite 26 zu Rate ziehen. Sollte die Kaffeemaschine hingegen kein Symbol anzeigen, bitte die folgenden Überprüfungen vornehmen, bevor Sie sich an den Kundendienst wenden.

**Der Kaffee ist nicht heiß**

- Die Tassen wurden nicht vorgewärmt.
-  Die Tassen vorwärmen, indem Sie sie mit warmem Wasser ausspülen oder mindestens 20 Minuten auf die beheizten Tassenablage (H) stellen (siehe „Tipps für die Ausgabe eines heißeren Kaffees:“ Seite 17).

**Der Kaffee hat wenig Crema**

- Der Kaffee ist zu grob gemahlen.
-  Den Knopf für die Mahlgradeinstellung eine Position gegen den Uhrzeigersinn drehen, solange das Mahlwerk während einer Kaffeezubereitung Kaffeebohnen mahlt (siehe „Mahlgrad einstellen“ Seite 21).
- Die Kaffeemischung ist nicht geeignet.
-  Eine für Kaffeevollautomaten geeignete Kaffeemischung verwenden.

**Der Kaffee tritt zu langsam aus**

- Der Kaffee ist zu fein gemahlen.
-  Den Knopf für die Mahlgradeinstellung eine Position im Uhrzeigersinn drehen, solange das Mahlwerk während einer Kaffeezubereitung Kaffeebohnen mahlt (siehe „Mahlgrad einstellen“ Seite 21).

**Der Kaffee tritt zu schnell aus**

- Der Kaffee ist zu grob gemahlen.
-  Den Knopf für die Mahlgradeinstellung eine Position gegen den Uhrzeigersinn drehen, solange das Mahlwerk während einer Kaffeezubereitung Kaf-

D

feebohnen mahlt (siehe „Mahlgrad einstellen“ Seite 21).

#### Der Kaffee fließt nur aus einem der Ausgüsse des Kaffeeauslaufs

- Die Löcher der Ausgüsse sind verstopft.
- ☞ Den angetrockneten Kaffee mit einer Nadel entfernen (Bild 29).

#### Trotz Drehen des Drehknopfs für Dampf und Heisswasser tritt kein Dampf aus der Dampfdüse

- Die kleinen Löcher der Dampfdüse und des inneren Teils der Dampfdüse sind verstopft.
- ☞ Die Löcher der Dampfdüse und des inneren Teils der Dampfdüse reinigen (siehe „Dampfdüse reinigen“ Seite 20).

#### Wenn die Funktion ☞ oder ☞ gewählt ist, tritt kein Kaffee, sondern Wasser aus der Maschine heraus

- Das Kaffeepulver könnte in dem Einfüllschacht stecken geblieben sein.
- ☞ Das den Einfüllschacht verstopfende Kaffeepulver mit Hilfe eines Messers beseitigen (siehe „Kaffee mit Pulver zubereiten“ Seite 18) (Bild 22). Dann die Brüheinheit und das Maschineninnere reinigen (siehe „Brüheinheit reinigen“ Seite 23)

#### Bei Drücken der Taste ① schaltet sich die Maschine nicht ein

- Der Hauptschalter an der Geräterückseite ist nicht eingeschaltet (Bild 8) oder der Netzstecker ist nicht eingesteckt.
- ☞ Kontrollieren, dass der Hauptschalter in der „I“-Position ist, und dass das Netzkabel richtig in der Steckdose steckt.

#### Die Brüheinheit lässt sich zur Reinigung nicht herausnehmen

- Die Kaffeemaschine ist eingeschaltet. Die Brüheinheit kann nur bei ausgeschalteter Maschine entnommen werden.
- ☞ Gerät ausschalten und die Brüheinheit entnehmen (siehe „Brüheinheit reinigen“ Seite 23).

- ☹ **Achtung:** Die Brüheinheit kann nur herausgenommen werden, wenn das Gerät mit der Taste Ein/Aus ① an der Gerätevorderseite ausgeschaltet ist. Das Gerät soll nicht vom Stromnetz getrennt werden. Falls Sie versuchen sollten, die Brüheinheit bei eingeschalteter Kaffeemaschine herauszunehmen, könnte diese ernsthaft beschädigt werden.

#### Der Kaffee tritt nicht aus den Ausgüssen des Kaffeeauslaufs, sondern seitlich aus der Servicetür heraus

- Die Öffnungen des Kaffeeauslaufs sind mit angetrocknetem Kaffee verstopft.
- ☞ Den angetrockneten Kaffee mit einer Nadel entfernen (Bild 29).
- Das innen an der Serviceklappe befindliche Schwenkfach (R) ist blockiert und schwingt nicht.
- ☞ Das Schwenkfach sorgfältig reinigen, insbesondere in der Nähe der Scharniere, sodass diese beweglich bleiben.

#### Es wurde Kaffeepulver verwendet (anstatt der Kaffeebohnen), und die Maschine gibt keinen Kaffee ab.

- Es wurde zuviel vorgemahlener Kaffee eingefüllt.
- ☞ Die Brüheinheit entnehmen und das Innere der Maschine wie unter „Brüheinheit reinigen“ Seite 23 beschrieben sorgfältig reinigen. Den Vorgang wiederholen und dabei maximal 2 gestrichenen Messlöffel Kaffeepulver verwenden.
- Der Drehknopf "Kaffeestärke / vorgemahlener Kaffee" wurde nicht in die Position ☞ oder ☞ gestellt und das Gerät hat sowohl den vorgemahlenden Kaffee als auch das vom Mahlwerk gemahlene Kaffeepulver benutzt.
- ☞ Das Innere der Maschine sorgfältig reinigen, wie unter „Brüheinheit reinigen“ Seite 23 beschrieben. Den Vorgang wiederholen, dabei zuerst den Drehknopf "Kaffeestärke / vorgemahlener Kaffee" in die richtige Position stellen wie unter „Kaffee mit Pulver zubereiten“ Seite 18 beschrieben.

- Der vorgemahlene Kaffee wurde bei ausgeschalteter Maschine eingefüllt.
- ☞ Die Brüh Einheit entnehmen und das Innere der Maschine wie unter „Brüh Einheit reinigen“ Seite 23 beschrieben sorgfältig reinigen. Den Vorgang bei eingeschalteter Maschine wiederholen.

#### Was tun, wenn das Gerät transportiert werden soll?

- Originalverpackung als Transportschutz aufbewahren. Zum Schutz gegen Kratzer unbedingt den Original-Plastikbeutel verwenden.
- Gerät und Warmhaltekanne gegen Stöße sichern. Es kann keine Haftung für Schäden während des Transports übernommen werden.
- Wassertank und Tresterbehälter leeren.
- Bitte achten Sie auch auf den Standort des Gerätes, vor allem während der kalten Jahreszeit. Es können Frostschäden entstehen.



## 17 Statistik-Modus



Das Gerät bietet die Möglichkeit, folgende Werte abzufragen:

- die Anzahl aller bisher mit dem Gerät zubereiteten Kaffees,
- die Anzahl der zubereiteten Kannen mit 4 Tassen, mit 6 Tassen, 8 Tassen und 10 Tassen,
- die Anzahl der durchgeführten Entkalkungen, und ausserdem
- die Anzahl Liter Wasser, die mit der Maschine ausgegeben wurden.







- ☐ Werden gleichzeitig 2 Tassen Kaffee bezogen, so werden diese auch als 2 Tassen gezählt.

Um den Statistik-Modus einzuschalten, muss das Gerät ausgeschaltet sein.

- ☞ Falls nötig, das Gerät mit der Taste „Ein/Aus“  ausschalten (Bild 11).
- ☞ Die Taste "P" (Bild 4) mindestens 6 Sekunden lang drücken. Die Symbole "P" und  leuchten. Ausserdem leuchten die 3 kleinen Sym-





bole über den Tasten ,  und , um die momentane Funktion dieser Tasten anzuzeigen, siehe „Spezial-Modus“ Seite 13.

- ☞ Drücken Sie die Tasten Blättern "<" oder ">" (Bild 5) so oft bis das Symbol leuchtet, für das die zugehörige Statistik angezeigt werden soll:

-  Anzahl zubereiteter Kaffees
-  Anzahl durchgeführte Entkalkungen
-  Anzahl zubereiteter Kannen mit 4 Tassen
-  Anzahl zubereiteter Kannen mit 6 Tassen
-  Anzahl zubereiteter Kannen mit 8 Tassen
-  Anzahl zubereiteter Kannen mit 10 Tassen
-  Anzahl ausgegebener Liter Wasser

Wenn ein Symbol leuchtet, können Sie die zugehörige Anzahl wie folgt anzeigen:

- ☞ Taste "OK" drücken und halten (Bild 5). Jetzt fangen einzelne Anzeigen nacheinander an zu blinken, womit die abgefragte Anzahl angezeigt wird:





-  1 x blinken entspricht 1
-  1 x blinken entspricht 10
-  1 x blinken entspricht 100
-  1 x blinken entspricht 1,000
-  1 x blinken entspricht 10,000

Die Blinkzeichen werden laufend wiederholt, solange die Taste "OK" gedrückt wird. Vor jeder Wiederholung wird eine Pause von 3 Sekunden eingelegt.

- ☞ Zählen Sie die Anzahl der einzelnen Blinkzeichen.

D

Beispiel: Die folgende Blinkfolge entspricht der Zahl 1.529.

-  9 x blinken
-  2 x blinken
-  5 x blinken
-  1 x blinken
-  0 x blinken

-  Um den Statistik-Modus zu verlassen, die Taste "P" (Bild 4) mindestens 6 Sekunden lang drücken.

## 18 Technische Daten

Netzspannung: 220-240 V  
Leistungsaufnahme: 1350 W

 Dieses Gerät entspricht den folgenden EG-Richtlinien:

- 73/23/EWG vom 19.2.1973 „Niederspannungsrichtlinie“, einschließlich Änderungsrichtlinie 93/68/EWG.
- 89/336/EWG vom 3.5.1989 „EMV-Richtlinie“, einschließlich Änderungsrichtlinie 92/31/EWG.

## 19 Entsorgung



### Verpackungsmaterial

Die Verpackungsmaterialien sind umweltverträglich und wiederverwertbar. Die Kunststoffteile sind gekennzeichnet, z.B. >PE<, >PS< etc. Entsorgen Sie die Verpackungsmaterialien entsprechend ihrer Kennzeichnung bei den kommunalen Entsorgungsstellen in den dafür vorgesehenen Sammelbehältern.



### Altgerät

Das Symbol  auf dem Produkt oder seiner Verpackung weist darauf hin, dass dieses Produkt nicht als normaler Haushaltsabfall zu behandeln ist, sondern an einem Sammelpunkt für das Recycling von elektrischen und

elektronischen Geräten abgegeben werden muss. Durch Ihren Beitrag zum korrekten Entsorgen dieses Produkts schützen Sie die Umwelt und die Gesundheit Ihrer Mitmenschen. Umwelt und Gesundheit werden durch falsches Entsorgen gefährdet. Weitere Informationen über das Recycling dieses Produkts erhalten Sie von Ihrem Rathaus, Ihrer Müllabfuhr oder dem Geschäft, in dem Sie das Produkt gekauft haben.

## 20 Im Service-Fall

Bei einer evtl. erforderlichen Reparatur, einschließlich Ersatz der Netzzuleitung, wenden Sie sich bitte **zunächst telefonisch an unsere Serviceline AEG-Electrolux**.

# AEG

 Electrolux

**Für Deutschland** : 01801 - 20 30 60\*

(\*Ortsstarif aus dem Festnetz der Deutschen Telekom)  
montags bis freitags von 8.00 - 18.00 Uhr

**Für Österreich:**

Für Reparaturservice: 0810-955 400 \*

Für Produktservice: 0810-955 200\*

\*aus dem Festnetz der TELEKOM AUSTRIA Euro 0,10/Min.

Die Originalverpackung inklusive Aufschäumteile unbedingt aufbewahren. Um Transportschäden zu vermeiden, muss das Gerät sicher verpackt sein.

Bei Einsendung des Gerätes immer die Warmhaltekanne beifügen. Diese wird zum Gerätetest benötigt.

Die Garantiezeit beträgt 2 Jahre nach Kaufdatum. Die Garantiezeit ist auf 6 Monate beschränkt, wenn das Gerät gewerblich genutzt wird. Unter gewerblicher Nutzung werden mehr als 3000 Brühzyklen pro Jahr verstanden.

**GB Dear Customer**

Please read this user manual carefully, paying special attention to the safety notes! Keep the manual in a safe place for later reference, and pass it on to any new owner.

**Contents**

<b>1</b>	<b>Figure captions</b>	<b>32</b>	<b>10</b>	<b>Preparing hot water</b>	<b>42</b>
1.1	Front view (Fig. 1)	32	<b>11</b>	<b>Setting the grinding texture</b>	<b>42</b>
1.2	Front view with open service door (Fig. 2)	32	<b>12</b>	<b>Setting the coffee temperature</b>	<b>43</b>
1.3	Control panel (Fig. 3)	32	<b>13</b>	<b>Cleaning and Care</b>	<b>43</b>
<b>2</b>	<b>Coffee and espresso</b>	<b>33</b>	13.1	Regular cleaning	43
<b>3</b>	<b>Safety Information</b>	<b>33</b>	13.2	Emptying the waste coffee container	44
<b>4</b>	<b>Special mode</b>	<b>35</b>	13.3	Cleaning the grinder	44
<b>5</b>	<b>Before using for the first time</b>	<b>35</b>	13.4	Cleaning the brewing unit	44
5.1	Setting up and connecting the coffee machine	35	13.5	Running the descaling program	45
5.2	Filling with water	35	<b>14</b>	<b>Ordering Accessories</b>	<b>46</b>
5.3	Filling the coffee bean container	35	<b>15</b>	<b>What to do if you see the following symbols on the display ...</b>	<b>46</b>
5.4	Switching on for the first time	36	<b>16</b>	<b>Problems that can be resolved before calling the Customer Service Centre</b>	<b>47</b>
5.5	Switching on the machine	36	<b>17</b>	<b>Statistic mode</b>	<b>49</b>
5.6	Switching off the machine	36	<b>18</b>	<b>Technical Data</b>	<b>50</b>
5.7	Setting the water hardness	37	<b>19</b>	<b>Disposal</b>	<b>50</b>
<b>6</b>	<b>Making coffee with beans</b>	<b>37</b>	<b>20</b>	<b>If service is needed</b>	<b>51</b>
6.1	Tips for making hotter coffee	39			
<b>7</b>	<b>Making several cups of coffee with the jug function</b>	<b>39</b>			
<b>8</b>	<b>Using pre-ground coffee</b>	<b>40</b>			
<b>9</b>	<b>Frothing milk</b>	<b>41</b>			
9.1	Cleaning the steam nozzle	41			

(GB)















**1 Figure captions****1.1 Front view (Fig. 1)**

- A Drip grid
- B Thermos jug
- C Main switch (rear side of appliance)
- D Height-adjustable coffee dispenser
- E Control panel (see Fig. 3)
- F Bean container lid
- G Pre-ground coffee lid
- H Heated cup rack
- J Swivel pipe for steam and hot water
- K Steam nozzle (removable)
- L Inner part of steam nozzle (removable)
- M Service door opening button
- N Water tank with max. fill level indication (removable)
- O Drip tray with float (removable)

**1.2 Front view with open service door (Fig. 2)**

- P Service door (open)
- Q Waste coffee container (removable)
- R Tilt compartment
- S Brewing unit
- T Knob for setting grinding texture
- U Bean container
- V Measuring spoon
- W Funnel for pre-ground coffee
- X Type plate (under appliance)
- Y Liquid descaler
- Z Test strip for water hardness

**1.3 Control panel (Fig. 3)**

- a "Coffee strength / Pre-ground coffee" knob
- b "Cup size" knob
- c Display
- d "1 cup of coffee" key   
In special mode, use this key for "scrolling" (" $<$ ")
- e "2 cups of coffee" key   
In special mode, use this key for "scrolling" (" $>$ ")
- f "Steam" key   
In special mode, use this key to confirm ("OK")
- g "P" key  
In special mode, this key returns to the last level without changing settings ("P")
- h "ON/OFF" key 
- j Knob for "Steam / Hot water"
- k "Jug coffee function" key 
- l "Pre-ground coffee" symbols
- m "Jug coffee function" symbols
- n "Coffee strength" symbols
- o "Cup size" symbols
- p "Fill water tank" symbol 
- q "Descale" symbol 
- r "Machine temperature" symbol 
- s "Servicedoor open" symbol 
- t "Waste coffee container" symbol 
- u "Attention" symbol 
- v "Hot water" symbol 
- w "Steam" symbol 
- x "Preparing 2 cups" symbol 
- y "Preparing 1 cup symbol" 
- z Symbols for the special mode



## 2 Coffee and espresso

Your fully automated coffee machine guarantees you absolute **ease of operation**, both in making coffee and in maintenance and care.

The excellent, individual **taste** is achieved by

- the pre-brewing system: before the coffee is brewed, it is first moistened to extract its full aroma
- the individually controllable amount of water per cup, from a short espresso to a "long" milky coffee
- the individually controllable temperature at which the coffee is made
- The choice between a normal or a strong cup of coffee
- the grinding texture, which can be adjusted according to type of coffee bean, and
- last, but not least, the guaranteed crema, that small crown of froth that makes espresso coffee so unique for connoisseurs

**Did you know?** The time the water is in contact with the ground coffee is considerably less for espresso coffee than conventional filter coffee. As a result, less bitterness is released from the ground coffee – making espresso coffee that much milder!

## 3 Safety Information



This appliance conforms to accepted technological standards with regard to safety, and to the Appliance Safety Law. As the manufacturer, we nevertheless wish to familiarise you with the following safety information.

### General safety

- The coffee machine must be connected only to a mains power current of which the voltage, type of supply and frequency conform to the details shown on the type plate (this can be found on the underside of the appliance)!
- Never allow the mains lead to come into contact with hot parts of the appliance.
- Never use the mains lead to pull the plug out of the mains socket!
- Do not use the coffee machine if:
  - the mains lead is damaged, or
  - the housing shows visible signs of damage.
- Ensure that the coffee machine is switched off before plugging into the mains socket.
- This appliance is not intended for use by people (including children) who, due to lack of experience or knowledge, are unable to operate it safely, or for use by people (including children) whose physical, sensory or mental capabilities are reduced, unless a person responsible for them has shown them how to use it safely, and has supervised them initially.

### Child safety

- **Do not leave the coffee machine running unattended, and take special care when children are about!**
- Packaging material, e.g. plastic bags, should not be accessible to children.

### Safety in operation

- **Caution!** The coffee dispenser, steam nozzle and cup rack become hot in operation. Keep children at a safe distance!

GB

- **Caution! Danger of scalding when the steam nozzle is activated! Hot water or steam output can cause scalding. Activate the steam nozzle only when you are holding a container under the nozzle.**
- Do not use steam to heat inflammable liquids!
- Only use the coffee machine with water in the system! Fill the water tank only with cold water. **Do not use hot water, milk or other liquids.** Do not exceed the maximum fill level of approx. 1.8 litres.
- **Do not put frozen or caramelised coffee beans in the bean container. Use only roasted coffee beans! Remove any foreign objects, such as small stones, from the coffee beans. Blocking or damage caused by foreign objects in the grinder might be excluded from the guarantee.**
- Spoon only ground coffee into the ground coffee filler.
- Do not leave the coffee machine switched on unnecessarily.
- Do not expose the coffee machine to the effects of weather.
- When using an extension lead, use only a commercially available cable with a conductor cross-section of at least 1.5 mm<sup>2</sup>.
- To avoid injury, people with motor system disorders should never use the machine without an accompanying person.
- **Operate the machine only when the drip tray, waste coffee container and the drip grid are installed!**

#### Safety in cleaning and care

- Follow the cleaning and descaling instructions.
- Switch off the coffee machine and unplug it from the mains socket before carrying out any maintenance or cleaning!
- Do not immerse the coffee machine in water.

- Only clean the steam nozzle when the machine is switched off, cold and not under pressure!
- Do not clean coffee machine parts in the dishwasher.
- **Never put water in the grinder.** This would damage the grinder.

Never open or repair the coffee machine. Faulty repairs can result in considerable hazard to the user.



Repairs to electrical appliances must be carried out only by qualified service engineers.



If a repair becomes necessary, including replacement of the mains lead, please contact

- the dealer where you bought the coffee machine, or
- the AEG/Electrolux Service Line.

**If the machine is misused or incorrectly operated the manufacturer accepts no liability for damage and the guarantee is invalidated - likewise if the descaling program is not carried out in accordance with these operating instructions immediately after the symbol  comes on. Blocking or damage caused by foreign objects in the grinder might be excluded from the guarantee.**



## 4 Special mode

For setting the water hardness („Setting the water hardness", page 37) and the coffee temperature („Setting the coffee temperature", page 43), for starting the descaling program („Running the descaling program", page 45) and for viewing the statistics („Statistic mode", page 49), you can switch to a special mode by pressing the "P" key (Fig.4). In this mode, you can navigate by means of the "1 cup of coffee" , "2 cups of coffee" , "Steam"  and "P" keys. The respective function in each case is shown in the display above the key (Fig. 5):

- «<» ("1 cup of coffee" ) and «>» ("2 cups of coffee" ) are for "scrolling"
- «OK» ("Steam" ) confirms an item
- «P» ("P") returns to the last level without changing settings.

## 5 Before using for the first time

### 5.1 Setting up and connecting the coffee machine





-  Place the machine on a suitable horizontal, stable, unheated and water-resistant surface.
-  Ensure that there is good air circulation. After positioning the appliance on the work top, leave a space of at least 5 cm between the surfaces of the appliance and the side and rear walls and at least 20 cm above the coffee maker.  
Never install the appliance in environments where the temperature may reach 0°C or lower (the appliance may be damaged if the water freezes).
-  Important! If the coffee machine is brought into a warm room from a cold environment, wait about two hours before switching on!

We advise you to place the coffee machine on a suitable mat to prevent damage being caused by spray and splashes.

-  Plug the coffee machine into an earthed mains socket. Do not use a socket that is not earthed.

### 5.2 Filling with water

Each time before switching on the coffee machine, check that there is water in the water tank, and refill if necessary. The coffee machine requires water for the automatic rinsing processes each time the machine is switched on or off.

-  Remove the water tank from the coffee machine (Fig. 6). Before the tank is removed, the steam nozzle must always be positioned towards the centre of the appliance, otherwise the tank cannot be removed.
-  Fill the water tank with fresh cold water. Never exceed the MAX line.
-  Pour only fresh cold water into the water tank. Never put in other liquids, e.g. mineral water or milk.
-  Replace the water tank (Fig. 6). Press the tank firmly in, to ensure that the water tank valve opens.
-  To always be sure of obtaining a rich coffee with a full aroma, you should:
  - change the water in the water tank daily,
  - wash the water tank at least once a week in normal washing-up water (not in the dishwasher). Then rinse with fresh water.

### 5.3 Filling the coffee bean container

-  Raise the lid of the coffee bean container, and fill the container with fresh coffee beans (Fig. 7). Then reclose the lid.

(GB)

 **Note!** Do not put frozen or caramelised coffee beans in the bean container. Use only roasted coffee beans! Make sure that no foreign objects, such as small stones, enter the coffee bean container. **Blocking or damage caused by foreign objects in the grinder might be excluded from the guarantee.**

 The grinder is factory-set to a medium grinding texture. If necessary, you can change this setting. Notes on changing the grinder setting can be found in „Setting the grinding texture“, page 42.

 **The grinder setting may be changed only while coffee is being ground. Making adjustments to the stationary grinder can damage the coffee machine.**

 Coffee has been used to factory-test the appliance, and it is therefore completely normal for there to be traces of coffee in the mill. This appliance is however guaranteed to be new.

#### 5.4 Switching on for the first time

When you operate the machine for the first time, the coffee machine has to be vented.

 Switch on the machine with the main switch on the rear of the machine (Fig. 8).

If the main switch is switched on for the very first time, all symbols in the display come on for a few seconds for a check, then the symbols ☰ and ▲ are flashing.

 Fill the water tank; see „Filling with water“, page 35.

 Replace the water tank (Fig. 6). Press the tank firmly in, to ensure that the water tank valve opens.

 Move the steam nozzle outwards and place a cup underneath it (Fig. 9).

 Turn the knob for steam and hot water anticlockwise as far as it will go to the position ☰ (Fig. 10).

Water runs out of the steam nozzle. The symbols ☰ and ▲ are on steady.

When the cup contains about 30 ml of water, the symbols ☰ and ▲ start flashing.

 Turn the steam knob clockwise (Fig. 10) as far as it will go, to the position ●, to stop the water running out.

The symbol ↓ flashes for a few seconds and the appliance switches itself off.

 Fill the coffee bean container with coffee beans; see „Filling the coffee bean container“, page 35.

#### 5.5 Switching on the machine

Each time before switching on, make sure there is water in the water tank and replenish if necessary. The machine requires water for the automatic rinsing cycles that are carried out each time the appliance is switched on or off.

 Switch the machine on with the "On/Off" key ⓪ (Fig. 11).

 Immediately after being switched on the machine runs through a set-up cycle. The noises occurring are perfectly normal.

 During the heating-up phase (approx. 120 seconds) the symbol ↓ flashes.

During pre-heating, the appliance performs an automatic rinse cycle (a little hot water runs out of the spouts and is collected in the drip tray beneath).

When pre-heating is complete, the symbol ↓ remains constantly on.

The coffee machine is now ready to use. The symbols shown on the display depend on the last coffee mode that was selected.

#### 5.6 Switching off the machine

 Switch the machine off with the "On/Off" key ⓪ (Fig. 11).

The symbol ↓ flashes. The machine carries out a rinsing cycle and turns off.

 If the coffee machine is not used for a longer period of time, it automatically switches off for economy reasons after 3 hours.

**i** If you will not be using the machine for a longer period of time, after switching off the "On/Off" key , you should also switch off the main switch at the back (Fig. 8).

## 5.7 Setting the water hardness

After putting the machine into operation for the first time, or when using a different water quality, you should set the machine to the water hardness level corresponding to the local water hardness. You can use the enclosed test strip to determine the water hardness, or contact your local water supply company.

### Determining water hardness

 Dip the test strip in cold water for around 1 second. Shake off the excess water, and gauge the hardness by means of the pink bands.

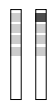

**No pink bands or one pink band:**  
**Hardness level 1, soft**  
up to 1.24 mmol/l, or  
up to 7° German hardness, or  
up to 12.6° French hardness



**Two pink bands:**  
**Hardness level 2, medium hard**  
up to 2.5 mmol/l, or  
up to 14° German hardness, or  
up to 25.2° French hardness

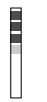

**Three pink bands:**  
**Hardness level 3, hard**  
up to 3.7 mmol/l, or  
up to 21° German hardness, or  
up to 37.8° French hardness

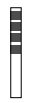





**Four pink bands:**  
**Hardness level 4, very hard**  
over 3.7 mmol/l or  
over 21° German hardness, or  
over 37.8° French hardness

### Setting and saving the water hardness level

You can set 4 hardness levels. The coffee machine is factory-set to hardness level 4.



 With the machine switched on, press the "P" key (Fig. 4).



The symbols "P" and  come on. Furthermore 3 small symbols above the ,  and  buttons come on to show the present function of these buttons, see „Special mode“, page 35.

 Confirm the selection with the "OK" key (Fig. 5).

The display indicates the current setting. The hardness levels are indicated as follows:

 Hardness level 1

  Hardness level 2

   Hardness level 3

    Hardness level 4

 Then press the scrolling keys "<" or ">" (Fig. 5) until the determined hardness level is displayed.

 Confirm the selection with the "OK" key (Fig. 5). This hardness level is now programmed.

**i** To cancel without storing the setting, press "P" instead of "OK".

If "OK" is not pressed, after about 120 sec., the appliance returns automatically to the coffee mode without storing the settings.

 To return to the coffee mode, then press the "P" key (Fig. 4) or wait about 120 sec. for the machine to automatically return to the coffee mode.

## 6 Making coffee with beans

The following process for making coffee with beans runs **completely automatically**: Grinding, portioning, pressing, pre-brewing, brewing and ejection of the coffee grounds.

The facility to select the grinding texture and the quantity of coffee to be ground allows you to individually set up the coffee machine to suit your own personal taste.





 Ensure that you use only pure coffee beans with no caramelised or aromatised additives. Do not use frozen beans.

GB

Depending on your taste, select a "short" espresso or a "long" milky coffee.

-  To choose the required cup size, turn the knob for "Cup size" (Fig. 12). The selected cup size will be indicated.





-  The cup sizes are indicated as follows:

	espresso cup
	small cup
	medium cup
	large cup
	mug



You can also choose coffee with an extra-mild, mild, normal, strong or extra-strong strength.



-  To choose the required strength, turn the knob for "Coffee strength selection" (Fig. 13). The selected coffee strength will be indicated.

-  The coffee strength is indicated as follows:



	extra-mild
	mild
	normal
	strong
	extra-strong







-  Place one or two cups under the coffee dispensing spouts (Fig. 14). The dispenser can be slid up or down, to match the height of your cup/mug to reduce heat loss and coffee splashes (Fig. 15).



-  Press the key for "1 cup"  to make one cup, or the key for "2 cups"  to make 2 cups.

The symbol "1 cup"  or "2 cups"  comes on. The appliance now grinds the beans. In the coffee-making process, the ground coffee is first of all wetted with a small quantity of water for pre-brewing. Following a short pause, the actual brewing process commences. The coffee is dispensed into the cup.



When the desired quantity of coffee has been dispensed, the appliance automatically stops delivering the coffee and ejects the grounds into the



waste coffee container. During this time, the symbol "1 cup"  or "2 cups"  flashes.



-  You can stop the delivery of coffee prematurely at any time, by briefly pressing the key for "1 cup"  or "2 cups" , or by turning the knob for "Cup size" (Fig. 12) anti-clockwise towards the "Espresso cup" position.
-  As soon as delivery is complete, to increase the quantity of coffee, simply press and hold the key for "1 cup"  or "2 cups"  until the desired quantity is reached, or turn the knob for "Cup size" (Fig. 12) clockwise towards the "Mug" position (this operation must be performed immediately after the coffee is dispensed and before the coffee grounds are ejected into the waste coffee container).

After a few seconds, when the flashing symbol "1 cup"  or "2 cups"  goes off, the appliance is ready for use again and you can make another coffee.

-  If the coffee is delivered a drop at a time or not at all, or the coffee is delivered too fast and is not creamy enough, you should change the grinding setting; see „Setting the grinding texture“, page 42.

-  If the symbols  and  are flashing, the coffee is ground too fine. You should change the grinding setting; see „Setting the grinding texture“, page 42.

-  If the symbol  comes on the water tank must be refilled or the appliance will not make coffee. (It is normal for there still to be some water left in the tank when the symbol is displayed).

-  If the symbol  comes on the waste coffee container is full and must be emptied and cleaned; see „Emptying the waste coffee container“, page 44. Until the waste coffee container has been cleaned, the appliance continues to display the symbol and cannot make coffee.



- i** Never remove the water tank whilst the machine is delivering coffee. If it is removed, the appliance will not be able to make any more coffee. To vent the appliance, turn the knob for steam and hot water anticlockwise as far as it will go, to the  setting, and run off water from the steam nozzle for a few seconds.
- i** When using the appliance for the first time, at least 4-5 cups of coffee need to be made before the appliance starts to yield satisfactory results.

### 6.1 Tips for making hotter coffee

- When you turn the appliance on, if you want to make a short coffee (less than 60 ml), use the hot rinse-through water to preheat the cups.
- Set a higher coffee temperature; see „Setting the coffee temperature“, page 43.
- Unless they have been pre-heated, do not use cups that are too thick, as they will absorb too much heat.
- Use cups that have been pre-heated by rinsing them with hot water or by leaving them for at least 20 minutes on the heated cup rack (H) with the coffee machine on.

## 7 Making several cups of coffee with the jug function

This function allows you to make several cups of coffee completely automatically, which are poured into the stainless steel thermos jug that is supplied: Grinding, portioning, pressing, pre-brewing, brewing and ejection of the coffee grounds are as described in the previous section.

-  Turn the lid of the stainless steel thermos jug to the position for removal (Fig. 16), and take the lid off the jug. Rinse both the lid and the thermos jug.
-  Place the thermos jug under the coffee dispenser (D), with the lid in position

for pouring (Fig. 17). The dispenser must be slid up fully to allow the jug to be pushed in.

One of the symbols for the jug function comes on, depending on the number of cups selected the last time the jug function was used. Also the scrolling keys "<" and ">" are illuminated.

The numbers of cups to be dispensed into the thermos jug are indicated as follows:

 4 cups



 6 cups



 8 cups

 10 cups

-  Check that the water tank is full, the bean container has enough coffee beans, and the waste coffee container is empty in order to allow the preparation of a series of coffees for the jug.

- i** If you wish to change the strength and size of the cups for the jug function, use the knob for "Cup size" (Fig. 12) resp. the knob for "Coffee strength selection" (Fig. 13) as described in the section „Making coffee with beans“, page 37.

-  If necessary, press the scrolling keys "<" or ">" to choose the symbol according to the number of cups you wish to pour into the jug, e.g.  for 8 cups.

-  Press the "JUG" key  (Fig. 18).

During preparation, the symbol for the selected number of cups is flashing.

Once the brewing is finished, all symbols of the jug function are flashing alternately, whereby the symbol for the selected number of cups is lighted twice as long than the other symbols.

-  Now you can remove the thermos jug and close the lid (Fig. 19) to keep the coffee warm for a longer period of time.

The appliance returns automatically to the coffee mode.

GB

**i** If there are either not enough coffee beans or there is too little water to complete the requested operation, or the waste coffee container is full, the machine will stop the operation and the current program is cancelled. After the error has been rectified, the program must be restarted. The amount of coffee already in the jug must be taken into consideration, so that the jug is not over-filled.

**i** If the symbols ☕ and ⚠ are flashing, the coffee is ground too fine. You should change the grinding setting; see „Setting the grinding texture“, page 42.

## 8 Using pre-ground coffee

This function allows you to brew pre-ground coffee, e.g. decaffeinated coffee.

**!** Make sure that no ground coffee has remained in the filler, and that no foreign objects enter the filler. The ground coffee filler is not a storage container. The ground coffee must be fed directly into the brewing unit.

**☞** Turn the "Coffee strength / Pre-ground coffee" knob (Fig. 20) to the desired position ☞ (for 1 cup) or ☞☞ (for 2 cups) to select the pre-ground coffee function. This disables the coffee mill function. One symbol ☞ (for 1 cup) or both symbols ☞ ☞ (for 2 cups) are illuminated.

**☞** Open the lid of the ground coffee filler, and scoop in the fresh ground coffee (Fig. 21).

Use only the supplied measuring spoon. Never add more than 2 level measured scoops, otherwise either the appliance will not make the coffee, the ground coffee will be dispersed inside the appliance, dirtying it, or the coffee will be delivered drop by drop and the symbols ☕ and ⚠ are flashing.

Do not add ground coffee during the brewing process. Only put in ground coffee for the next cup when the

brewing process has completely finished and the coffee machine is ready. Never add the ground coffee when the appliance is off, as otherwise it will be dispersed inside the appliance.

**!** Use only ground coffee for fully automated espresso coffee makers. Do not put coffee beans, any water-soluble or freeze-dried instant products or any other drink powder into the ground coffee filler. Coffee powder which is too fine can lead to blockages.

**i** If the filler shaft is blocked (due to moisture inside the appliance, or because more than 2 measuring scoops of pre-ground coffee have been used), use a knife or a spoon handle to push the coffee down (Fig. 22). Then remove the brewing unit and clean it and the appliance as described in the section „Cleaning the brewing unit“, page 44“.

**☞** Close the lid.

**☞** To choose the required cup size, turn the knob for "Cup size" (Fig. 12) as described in the section „Making coffee with beans“, page 37.

**☞** Press the key for "1 cup" ☐ to make one cup, or the key for "2 cups" ☐☐ to make 2 coffees.

The coffee is prepared.















**i** If the pre-ground coffee function for 1 cup has been selected and the ground coffee has not been filled into the ground coffee filler, after pressing the ☐ button the symbols ☞ and ⚠ are flashing. If the pre-ground coffee function for 2 cups has been selected and the ground coffee has not been filled into the ground coffee filler, after pressing the ☐☐ button the symbols ☞ ☞ and ⚠ are flashing.

**i** Once the coffee has been prepared, to go back to making coffee using beans, turn the "Coffee strength / Pre-ground coffee" knob (Fig. 20) to any coffee strength setting (the coffee mill is enabled for operation again).





## 9 Frothing milk



The steam can be used to froth milk and to heat liquids. Since a higher temperature is needed to produce steam than to make coffee, the coffee machine has an additional steam mode.

-  To make a cappuccino, fill a large cup 1/2 to 2/3 full with espresso, and then add the frothed milk.
-  **Caution!** Danger of scalding when the steam nozzle is activated! Hot water or steam output can cause scalding. Do not activate the steam nozzle until it is immersed in the milk.
-  To produce steam, press the "Steam" key  (Fig. 23).  
The symbol  comes on and the appliance heats up. During the heating process, the symbol  flashes.  
When the heating process is finished, the symbol  remains constantly on. The machine is ready for the milk frothing.
-  If the steam function is not used for longer than 2 minutes, the machine switches back automatically to the coffee mode.
-  To avoid any residual water mixing in with the milk when frothing, the water should be drained off beforehand. To do this, place a container under the steam nozzle and turn the knob for steam and hot water (Fig. 10) to position  until steam emission starts. Then turn the knob back to position .
-  Pour low-fat, cold milk into a mug which must be small enough to fit under the steam nozzle.
-  The milk should be cold. You should also use a cold mug, preferably a stainless steel one, which should not be rinsed beforehand in hot water.
-  Swing out the steam nozzle and hold the mug under the steam nozzle so that the nozzle opening is just immersed in the milk (Fig. 24).



 **Attention!** Risk of impurities from dried on milk residues in the steam nozzle. Take care not to immerse the steam nozzle in the milk far enough to cover the air intake opening at the top of the steam nozzle. Otherwise milk can be sucked into the nozzle and cause impurities in the steam nozzle.



 Turn the knob for steam and hot water (Fig. 10) to the position . The milk is frothed.

 To obtain a creamier froth, slowly move the container upwards. Froth the milk to at least twice its volume.



 You should not discharge steam for more than two minutes at a time. To end the frothing, turn the knob for steam and hot water (Fig. 10) to the position  and then remove the mug.

 **Caution!** Danger of scalding from hot milk spray! Switch the steam off before removing the mug with the frothed milk.

 Exit the steam mode by pressing the "Steam" key  (Fig. 23) or wait approx. 120 sec. for the machine to automatically return to the coffee mode. Now the machine is once again ready for making coffee.

 Each time you have frothed milk, let off some hot water through the nozzle for a short time by turning the knob for steam and hot water (Fig. 10) to the  position.

This is necessary to prevent milk residues drying inside the nozzle, and thereby blocking it. Use a suitable container to catch the water. During this process the symbol  comes on.

 Then return the knob to the position ; the last selected coffee setting is shown in the display.

### 9.1 Cleaning the steam nozzle

**Important:** To guarantee hygiene, you are recommended to follow this procedure each time you make frothed milk, to avoid milk stagnating in the nozzle.

GB

- ☞ Turn the knob for steam and hot water clockwise as far as it will go to the position ●. Wait a couple of minutes for the steam nozzle to cool down.
- ☞ Then with one hand hold the swivel pipe handle firm and with the other disengage the bayonet connection of the steam nozzle by turning it slightly clockwise. Remove the steam nozzle by pulling it downwards (Fig. 25).
- ☞ Remove the inner part of the steam nozzle from the swivel pipe by pulling it downwards.
- ☞ Carefully wash the steam nozzle and the inner part in warm water.
- ☞ Make sure the two holes shown in fig. 26 are not blocked. If necessary, pierce them with a pin and clean them.
- ☞ Replace the inner part by pushing it slightly upwards onto the swivel pipe.
- ☞ Replace the steam nozzle by pushing it upwards and turning it anticlockwise.

## 10 Preparing hot water

The hot water can be used to pre-heat cups and for making hot drinks, e.g. tea or instant soups.

- ⚠ Caution! Danger of scalding when the hot water nozzle is activated! Hot water or steam output can cause scalding. Activate the hot water nozzle only when a container is under the hot water nozzle.
- ☞ Place a container under the hot water nozzle.
- ☞ Turn the knob for steam and hot water to the ☞☞☞ position (Fig. 10). Hot water is dispensed; the symbol ☞☞☞ comes on.
- ℹ You should not run off hot water for more than two minutes at a time.
- ☞ After you have dispensed the hot water turn the knob for steam and hot water back to the ● position (Fig. 10) and remove the container.

## 11 Setting the grinding texture

The appliance is preset to grind to a medium texture. If you find that coffee delivery is either too fast or too slow (in drips), the grinding texture can be adjusted during the grinding process.

- ⚠ The grinder setting may be changed only while coffee is being ground, i.e. the knob for setting the grinding texture (Fig. 2, T and Fig. 27) must be rotated only when the grinder is grinding beans during the preparation of coffee. Making adjustments to the stationary grinder can damage the coffee machine.

- ☞ Set the grinding texture (Fig. 27) using the knob for setting the grinding texture (Fig. 2, T).
  - If the coffee is delivered a drop at a time or not at all (probably the symbols ☞☞☞ and ☞☞☞ are flashing), turn the knob one click clockwise. Turn one click at a time until the coffee is delivered satisfactorily.
  - If the coffee is delivered too fast and the crema is not to your taste, turn the knob one click anticlockwise.

- ℹ Avoid turning the knob for setting the grinding texture too far, otherwise when you select 2 cups, the coffee may emerge drop by drop.















- ℹ The effect of these adjustments will only be evident after at least 2 cups of coffee have been prepared.

### Remove foreign objects from the grinder

Foreign objects such as small stones in the grinder can damage the grinder. A foreign objects in the coffee causes a loud, regular rattle. If you hear this noise while coffee is being ground, immediately switch off the coffee machine and call the Customer Service Centre. **Blocking or damage caused by foreign objects in the grinder might be excluded from the guarantee.**

## 12 Setting the coffee temperature











There are three temperature levels to choose from. The factory setting is «Temperature high». You can change this setting as follows:

-  Press the "P" key (Fig. 4).  
The symbols "P" and  come on. Furthermore 3 small symbols above the ,  and  buttons come on to show the present function of these buttons, see „Special mode“, page 35.
-  Press the scrolling keys "<" or ">" (Fig. 5) until the symbol  is illuminated.
-  Confirm with the "OK" key (Fig. 5).  
The display indicates the current setting. The temperature levels are indicated as follows:
  -  Temperature low
  -  Temperature medium
  -  Temperature high
-  Where necessary, select a different temperature, using the scrolling keys "<" or ">" (Fig. 5).
-  When the required temperature is indicated, confirm this with the "OK" key (Fig. 5). This temperature is now programmed.
-  To cancel without storing the setting, press "P" instead of "OK".  
If "OK" is not pressed, after about 120 sec. the appliance returns automatically to the coffee mode without storing the setting.
-  To return to the coffee mode, press the "P" key (Fig. 4) or wait about 120 sec. for the machine to return automatically to the coffee mode.

## 13 Cleaning and Care

To ensure consistent coffee quality and faultless operation, always keep your coffee machine clean.





### 13.1 Regular cleaning

-  **Caution!** Before cleaning, switch off the coffee machine and allow it to cool down.
-  **Note!** Never put the coffee machine or separate parts of the coffee machine in the dishwasher. Never immerse the coffee maker in water.
-  **Note!** Never put water in the coffee bean container, as this would damage the grinder.
-  Do not use any abrasive, scouring or corrosive cleaning materials. Wipe the inside and outside of the case only with a damp cloth.
-  Remove the water tank daily (Fig. 6) and discard any remaining water. Rinse out the water tank with fresh water. Use fresh water every day.
-  Empty the waste coffee container daily or at the latest when the display prompts you to do so; see „Emptying the waste coffee container“, page 44.
-  Regularly drain the drip tray. This can be done at any time, but must be done when the red drip tray float (Fig. 28) appears through the opening in the drip grid.
-  Regularly (at least once per week) clean the water tank (N), drip tray (O), drip grid (A) and waste coffee container (Q) with warm water, a mild washing up liquid and possibly a brush.
-  Each time the machine is used for frothing, remove the steam nozzle and clean off any milk residues, see „Cleaning the steam nozzle“, page 41.
-  Check that the holes in the coffee dispenser are not blocked. To unblock them, scrape any dry coffee residues away with a needle (Fig. 29).



(GB)

### 13.2 Emptying the waste coffee container

The appliance counts the number of coffees made. Every 14 single coffees (or 7 doubles) the symbol  comes on to indicate that the waste coffee container is full and must be emptied and cleaned. Until the waste coffee container has been cleaned, the appliance cannot make coffee.



-  To clean it, unlock and open the service door by pushing the respective button (Fig. 30), the symbol  comes on.
-  Then remove the drip tray (Fig. 31), and empty and clean it.
-  Empty the waste coffee container and clean it thoroughly, making sure that all residues deposited on the bottom are removed.

**Important:** Each time you pull out the drip tray, the waste coffee container **must** also be emptied, even if it is not completely full. If this is not done, when coffee is next made, the grounds in the container may exceed the maximum level and block the appliance.

-  When you have removed the drip tray, the symbol  flashes.
-  When the coffee machine is in daily use, empty the container daily. Always empty the container with the coffee machine switched on, otherwise the coffee machine does not register that the container has been emptied.

### 13.3 Cleaning the grinder

Use a soft brush or a vacuum cleaner to remove ground coffee residues from the coffee beans container.

-  **Note!** Never put water in the grinder. This would damage the grinder.
-  Press the "On/Off" key (Fig. 11) and the main switch (Fig. 8) to switch off the coffee machine. Unplug it from the mains socket.

-  Remove any remaining coffee beans (you could use the vacuum cleaner with the hose or crevice tool attachment for this).





-  If a foreign object is impossible to remove, contact the Customer Service Centre. **Blocking or damage caused by foreign objects in the grinder might be excluded from the guarantee.**

-  **Caution!** Risk of injury from the moving grinder. Never switch the coffee machine on when you are working on the grinder. This can lead to severe injuries. Before starting work, ensure that the machine is unplugged from the mains socket.

-  Use a small quantity of coffee beans to test the proper operation of the grinder by making a cup of coffee. The first time the grinder is used, or after cleaning, less ground coffee will enter the brewing unit, because the channel first has to be filled. This can influence the first cup of coffee.

### 13.4 Cleaning the brewing unit

We advise you to clean the brewing unit regularly (depending on how frequently it is used). If your coffee machine is to be left unused for some time (e.g. holidays), empty the waste coffee container and the water tank, and thoroughly clean the coffee machine, including the brewing unit. Proceed as follows:

-  Turn the appliance off by pressing the "On/Off" key (Fig. 11) (do not unplug) and wait for all symbols to go off.
-  Unlock and open the service door at the front by pushing the corresponding opening button (Fig. 30).
-  Remove the drip tray and the waste coffee container (Fig. 31) and clean them.
-  Press the two red release buttons on the brewing unit from the sides, pressing towards the centre (Fig. 32), and pull it out.

**i** **Important:** The brewing unit can only be removed if the appliance is turned off with the ON/OFF key  at the front of the machine. It should not be disconnected from the mains.

**Attempting to remove the brewing unit when the appliance is on may cause serious damage.**

 Wash the brewing unit under running water, without using detergents. **Never wash the brewing unit in the dishwasher.**

 Clean the inside of the appliance thoroughly. To remove coffee encrustations from the inside of the appliance, scrape with a plastic or wooden fork or similar tool that does not scratch the surface (Fig. 33), then vacuum up the residues with a vacuum cleaner (Fig. 34).

 Replace the brewing unit (Fig. 36, a) by pushing it onto the holder (Fig. 36, b) and pushing in the pin (Fig. 36, c). The pin must be inserted into the pipe at the bottom of the brewing unit (Fig. 36, d).

 Push the PUSH symbol (Fig. 36, e) firmly in until the brewing unit clicks into place.

 After having heard the click, check that the red buttons (Fig. 36, f) have snapped out, otherwise the service door cannot be closed.

- Fig. 37: The two red buttons have snapped out correctly.
- Fig. 38: The two red buttons have not snapped out.

 Replace the drip tray, complete with the waste coffee container.

 Close the service door.

**i** If the brewing unit is not inserted correctly, i.e. when you can hear that it has clicked into place, and the two red buttons have not snapped out correctly, the service door cannot be closed.

**i** If it is hard to insert the brewing unit, before inserting it squeeze it to the right height by pressing it firmly from

the top and bottom simultaneously, as shown in figure 35.

**i** If it is still hard to insert the brewing unit, leave it out of the appliance, close the service door, unplug the appliance from the mains, then plug in again.

Wait until all symbols has switched off, then open the service door and replace the brewing unit.

### 13.5 Running the descaling program





The descaling program allows you to descale your coffee machine simply and effectively. The coffee machine must be descaled when you are instructed to do so by the symbol  coming on.



**!** **Important:** Do not under any circumstances use any descalers which are not recommended by AEG/Electrolux. If other descaling agents are used, AEG/Electrolux accepts no liability for any damage. You can obtain descaling liquid from specialist retailers or from the AEG/Electrolux Service Line.



**i** The descaling process takes about 45 minutes and should not be interrupted. In the event of a power failure or interruption, the program must be restarted!

 Before starting the descaling program, clean the brewing unit (refer to „Cleaning the brewing unit“, page 44).

 Press the "P" key (Fig. 4).

The symbols "P" and  come on. Furthermore 3 small symbols above the ,  and  buttons come on to show the present function of these buttons, see „Special mode“, page 35

 Press the scrolling keys "<" or ">" (Fig. 5) until the symbol  is illuminated.

 Confirm with the "OK" key (Fig. 5). The symbols  and  are flashing and "P" is steady on.

**i** To cancel the descaling program at this point, switch the machine off with the "On/ Off" key  (Fig. 11).



(GB)

- ☞ Empty the water tank, fill the tank with at least 1 liter of water and add the descaling agent.



 Note: Make sure descaling agent is splashed onto surfaces sensitive to acid such as marble, limestone and ceramics.

- ☞ Place a container with a minimum capacity of 1.5 litres under the steam nozzle (Fig. 9).

- ☞ Turn the knob for steam and hot water to the position .

The descaling program starts and the descaling solution runs out of the steam nozzle. The symbols ,  and "P" are steady on.

The descaling programme automatically performs a series of flushes and pauses to remove limescale deposits from inside the coffee maker.

After approx. 30 minutes, the water tank will be empty and the symbols  and  are flashing and "P" is steady on.



- ☞ Turn the knob for steam and hot water back to the position .



The machine is now ready to be rinsed with fresh water.

- ☞ Remove the water tank and fill it with fresh water and then replace it in the appliance.

- ☞ Empty the container under the steam nozzle and replace it there.

- ☞ Turn the knob for steam and hot water to the position .

A rinsing procedure with fresh water is carried out and the rinse water runs out of the steam nozzle. The symbols ,  and "P" are steady on.

After a few minutes, the water tank will be empty and the symbols  and  are flashing and "P" is steady on.

- ☞ Turn the knob for steam and hot water back to the position .

The symbols as for the last coffee mode selected are shown, and the symbol  is steady on.

- ☞ Empty the container with rinsing water.

- ☞ Remove water tank, fill it with fresh water and replace it.

The machine is now ready for use and its status is as for the last coffee mode selected.

-  After running the descaling program, you are advised to throw away the first cup of coffee from the machine.

## 14 Ordering Accessories

To ensure years of satisfaction with your coffee machine and prevent faults arising, it is very important to descale the coffee machine regularly. The original descaling agent is obtainable direct from us.

If you live in Germany, please call our Order Hotline:

1801 - 20 30 60\*

(\*Local tariff on Deutsche Telekom's landline network)  
Monday to Friday 8.00 am - 6.00 pm

## 15 What to do if you see the following symbols on the display ...

### The symbol is on steady

- The water tank is empty or is positioned incorrectly.

- ☞ Fill the water tank, as described in section „Filling with water“, page 35, and insert it fully.

- The tank is dirty or encrusted with limescale.

- ☞ Rinse or descale the water tank.

### The symbols and are flashing

- The appliance cannot make coffee.

- ☞ Place a container under the steam nozzle and turn the knob for steam and hot water anticlockwise to the position  (Fig. 9).

- The coffee runs off too slowly.
- ☞ Turn the knob for setting grinding texture (Fig. 12) one click clockwise whilst the grinder is grinding beans for the preparation of next coffee (see „Setting the grinding texture“, page 42).

#### The symbol is on steady

- The waste coffee container is full.
- ☞ Empty the waste coffee container and clean it as described in the section „Emptying the waste coffee container“, page 44, then replace it.

#### The symbol is flashing

- The waste coffee container has probably not been replaced after cleaning.
- ☞ Open the service door and insert the waste coffee container.

#### The symbols or and are flashing

- With the ground coffee function selected, ground coffee has not been poured into the ground coffee filler.
- ☞ Add the ground coffee as described in chapter „Using pre-ground coffee“, page 40.

#### All coffee strength symbols and are flashing

- The coffee beans have run out.
- ☞ Fill the coffee bean container, see „Filling the coffee bean container“, page 35
- If the coffee grinder is very noisy, this could mean a small stone in the coffee beans has blocked the grinder.
- ☞ Contact the Customer Service Centre. **Blocking or damage caused by foreign objects in the grinder might be excluded from the guarantee.**

#### The symbol is on steady

- This indicates the presence of limescale in the appliance.
- ☞ The descaling procedure, described in the section „Running the descaling program“, page 45, needs to be performed as soon as possible.

#### The symbol is on steady

- The service door is open.
- ☞ Close the service door. If the service door cannot be closed, check that the brewing unit is inserted correctly (see „Cleaning the brewing unit“, page 44).



#### The symbol is flashing

- The brewing unit has probably not been replaced after cleaning.
- ☞ Insert the brewing unit; see „Cleaning the brewing unit“, page 44
- The inside of the appliance is very dirty.
- ☞ Thoroughly clean the inside of the appliance; see „Cleaning the brewing unit“, page 44. If the message is still displayed after cleaning, contact the Customer Service Centre.

#### The symbol is on steady

- This indicates a general alarm.
- ☞ Contact the Customer Service Centre.

#### The symbols and are flashing

- The machine has been switched on with the steam knob in open position .
- ☞ Turn the steam knob clockwise (Fig. 10) as far as it will go, to the position .

#### The symbols and are flashing

- The ambient temperature is too low to operate the appliance.
- ☞ Use the appliance in a warmer room.

## 16 Problems that can be resolved before calling the Customer Service Centre

If the appliance is not working, the causes of the malfunction can be identified and resolved by referring to chapter „What to do if you see the following symbols on the display ...“, page 46. If, on the other hand, no symbol is displayed, run the following checks before calling the Customer Service Centre.

(GB)

**The coffee is not hot**

- The cups have not been preheated.
- ☞ Pre-heat the cups by rinsing them in hot water or leaving them for at least 20 minutes on the heated cup rack (H) (see „Tips for making hotter coffee“, page 39).

**The coffee is not creamy enough**

- The coffee is ground too coarsely.
- ☞ Turn the knob for setting the grinding texture one click anticlockwise whilst the grinder is grinding beans for the preparation of next coffee (see „Setting the grinding texture“, page 42).
- Wrong type of coffee.
- ☞ Use a type of coffee for fully automated espresso makers.

**The coffee runs out too slowly**

- The coffee is ground too finely.
- ☞ Turn the knob for setting grinding texture one click clockwise whilst the grinder is grinding beans for the preparation of next coffee (see „Setting the grinding texture“, page 42).

**The coffee runs out too quickly**

- The coffee is ground too coarsely.
- ☞ Turn the knob for setting grinding texture one click anticlockwise whilst the grinder is grinding beans for the preparation of next coffee (see „Setting the grinding texture“, page 42).

**The coffee flows out of only one of the dispensers**

- The dispenser holes are blocked.
- ☞ Scrape off the dry coffee residues with a needle (Fig. 29).

**When the knob for steam and hot water is turned, no steam comes out of the steam nozzle**

- The holes in the steam nozzle and the inner part of the steam nozzle are clogged.
- ☞ Clean the holes in the steam nozzle and the inner part of the steam nozzle (see „Cleaning the steam nozzle“, page 41).

**When the ☞ or ☞☞ function is selected, the appliance does not deliver coffee, but only water**

- The ground coffee may be blocked in the ground coffee filler.
- ☞ Remove the ground coffee inside the filler using a knife (see „Using pre-ground coffee“, page 40) (Fig. 22). Then clean the brewing unit and the inside of the appliance (see „Cleaning the brewing unit“, page 44)

**When the button ① is pressed, the appliance does not switch on**

- The main switch at the back is not switched on (fig. 8) or the appliance is not plugged in.
- ☞ Check that the main switch is in the "I" position and that the power cable is plugged into the mains socket.

**The brewing unit cannot be removed for cleaning**

- The appliance is on. The brewing unit can only be removed if the appliance is off.
- ☞ Turn the appliance off and remove the brewing unit (see „Cleaning the brewing unit“, page 44).





- i** Important: The brewing unit can only be removed if the appliance is turned off with the ON/OFF key ① at the front. It should not be disconnected from the mains. Attempting to remove the brewing unit when the appliance is on may cause serious damage.

**The coffee does not run out from the dispenser outlets, but from around the sides of the service door**

- The holes in the dispenser outlets are clogged with dry coffee.
- ☞ Remove the dried coffee with a needle (Fig. 29).
- The tilt compartment (R) inside the service door is blocked and cannot swing.
- ☞ Thoroughly clean the tilt compartment, particularly near the hinges, to ensure they are free to swing smoothly.



### Ground coffee was used (not beans) and the appliance does not deliver any coffee

- Too much ground coffee has been added.
-  Remove the brewing unit and thoroughly clean the inside of the appliance, as described in „Cleaning the brewing unit“, page 44. Repeat the operation using a maximum of 2 scoops of ground coffee.
- The "Coffee strength / Pre-ground coffee" knob has not been turned to the  or  position and the appliance has used both the ground coffee that has been added and the coffee that has been ground by the grinder.
-  Thoroughly clean the inside of the appliance, as described in „Cleaning the brewing unit“, page 44. Repeat the operation, first turning the "Coffee strength / Pre-ground coffee" knob as described in „Using pre-ground coffee“, page 40.
- Ground coffee has been added when the appliance was switched off.
-  Remove the brewing unit and thoroughly clean the inside of the appliance, as described in the section „Cleaning the brewing unit“, page 44. Repeat the operation, but switch the appliance on first.

### What to do if the coffee machine has to be transported

- Keep the original packaging as transport protection. It is important to use the original plastic bag as a protection against scratches.
- Secure the coffee machine and the thermos jug against jarring. The manufacturer accepts no liability for damage during transportation.
- Empty the water tank and waste coffee container.
- Care should also be taken with the location of the coffee machine - especially in cold weather, when damage can be caused by frost.



## 17 Statistic mode

The coffee machine has the facility to indicate





- the total number of cups of coffee made,
- the number of jugs prepared, containing 4 cups, 6 cups, 8 cups and 10 cups,
- the number of descalings carried out, as well as
- the number of liters of water dispensed.

 Where 2 cups of coffee are dispensed simultaneously, there are also counted as 2 cups of coffee.







To activate the statistic mode, the coffee machine must be switched off.

 If necessary, switch the machine off with the "On/ Off" key  (Fig. 11).

 Press the "P" key (Fig. 4) for at least 6 seconds.

The symbols "P" and  come on. Furthermore 3 small symbols above the ,  and  buttons come on to show the present function of these buttons, see „Special mode“, page 35.





 Repeatedly press the scrolling keys "<" or ">" (Fig. 5) to illuminate the symbol, for which the relevant statistic should be indicated:

-  number of cups dispensed
-  number of descalings carried out
-  number of jugs with 4 cups dispensed
-  number of jugs with 6 cups dispensed
-  number of jugs with 8 cups dispensed
-  number of jugs with 10 cups dispensed
-  number of liters of water dispensed

When a symbol is illuminated, you can indicate the related number as follows:

(GB)





-  Press and hold the "OK" key (Fig. 5). Now individual indicator lights start to flash in sequence, showing the requested number:

	1 x flash corresponds to 1
	1 x flash corresponds to 10
	1 x flash corresponds to 100
	1 x flash corresponds to 1,000
	1 x flash corresponds to 10,000

The flashing sequence is continuously repeated, as long as the "OK" key is pressed. A pause of 3 seconds is made before each repetition.

-  Count the number of individual flashes by each indicator.

Example: The following flashing sequence corresponds to the number 1,529.

	9 x flashes
	2 x flashes
	5 x flashes
	1 x flash
	0 x flash

-  To exit this mode, press the "P" key (Fig. 4) for at least 6 seconds.

## 18 Technical Data

Mains voltage:	220–240 V
Power consumption:	1350 W

-  This coffee machine complies with the following EU Directives:
- 73/23/EEC of 19.2.1973 "Low Voltage Directive", including Amendment Directive 93/68/EEC.
  - 89/336/EEC of 3.5.1989 "EMC Directive", including Amendment Directive 92/31/EEC.

## 19 Disposal

### Packaging material

The packaging materials are environmentally friendly and can be recycled. The plastic components are identified by markings, e.g. >PE<, >PS<, etc. Please dispose of the packaging materials in the appropriate container at the community waste disposal facilities.

### Old appliance

The symbol  on the product or on its packaging indicates that this product may not be treated as household waste. Instead it shall be handed over to the applicable collection point for the recycling of electrical and electronic equipment. By ensuring this product is disposed of correctly, you will help prevent potential negative consequences for the environment and human health, which could otherwise be caused by inappropriate waste handling of this product. For more detailed information about recycling of this product, please contact your local city office, your household waste disposal service or the shop where you purchased the product.

## 20 If service is needed

If repairs should become necessary, including replacement of the mains cable, please telephone **in the first instance our AEG-Electrolux Service Line.**

# AEG

 Electrolux

**For Germany :** 01801 - 20 30 60\*

(\*Local tariff on Deutsche Telekom's landline network)  
Monday to Friday 8.00 am - 6.00 pm

**For Austria:**

For Repairs service: 0810-955 400 \*

For Product service: 0810-955 200\*

\*From TELEKOM AUSTRIA's landline network 0.10 Euro/min.

Original packaging, including expanded foam parts, must be retained.

To avoid damage in transport, the appliance must be packed securely.

When sending the appliance in, always add the jug. This is needed to test the appliance.

The warranty period runs for 2 years from the date of purchase. The warranty period is limited to 6 months if the appliance is used commercially. More than 3,000 brewing cycles per year is understood as commercial use.



GB

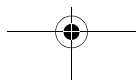
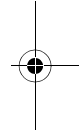
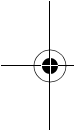
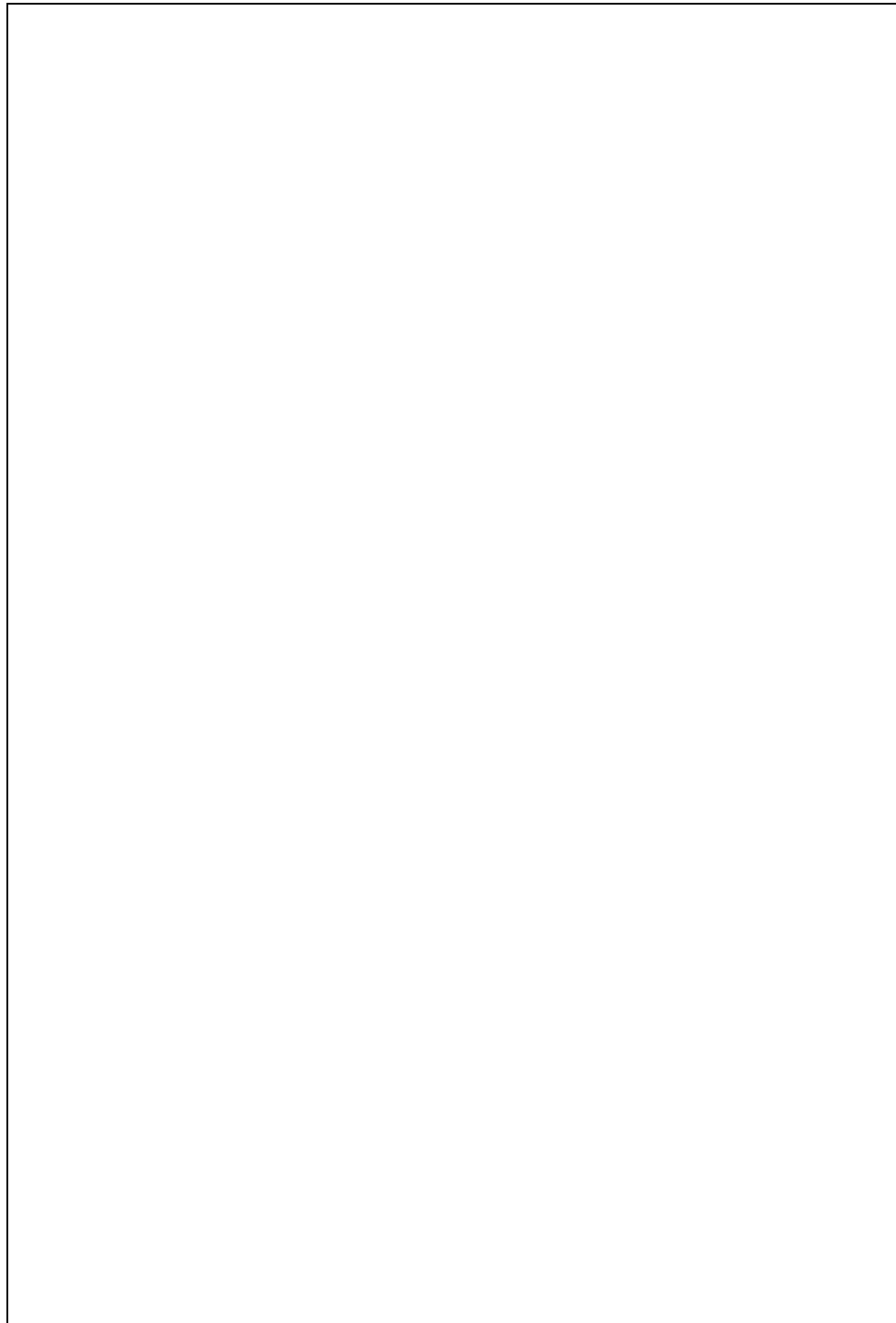

**F** **Très chère cliente,  
très cher client,**

veuillez lire attentivement le présent mode d'emploi. Respectez avant tout les consignes de sécurité. Conservez ces informations aux utilisateurs pour un usage ultérieur et transmettez-les à un éventuel possesseur ultérieur de la machine.

### Table des matières

<b>1</b>	<b>Légende des photos</b>	<b>54</b>	<b>10</b>	<b>Préparation d'eau chaude</b>	<b>65</b>
1.1	Vue de face (Figure 1)	54	<b>11</b>	<b>Régler le degré de mouture</b>	<b>65</b>
1.2	Vue de face avec panneau de service ouvert (Figure 2)		<b>12</b>	<b>Régler la température du café</b>	<b>66</b>
1.3	Panneau de commande (Figure 3)	54	<b>13</b>	<b>Nettoyage et entretien</b>	<b>66</b>
<b>2</b>	<b>Café et espresso</b>	<b>55</b>	13.1	Nettoyage régulier	66
<b>3</b>	<b>Consignes de sécurité</b>	<b>55</b>	13.2	Vider le bac à résidus	67
<b>4</b>	<b>Mode Spécial</b>	<b>57</b>	13.3	Nettoyer le broyeur	67
<b>5</b>	<b>Première mise en service</b>	<b>57</b>	13.4	Nettoyer l'unité d'infusion	68
5.1	Mettre l'appareil en place et le raccorder au secteur	57	13.5	Lancer le programme de détartrage	69
5.2	Remplir d'eau	57	<b>14</b>	<b>Commande d'accessoires</b>	<b>70</b>
5.3	Remplir le conteneur de grains de café	57	<b>15</b>	<b>Que faire lorsque le message suivant apparaît à l'écran ...</b>	<b>70</b>
5.4	Première mise en service	58	<b>16</b>	<b>Problèmes auxquels vous pouvez remédier avant d'appeler le Service Après-Vente</b>	<b>72</b>
5.5	Mise en marche de l'appareil	58	<b>17</b>	<b>Mode Statistique</b>	<b>73</b>
5.6	Arrêter l'appareil	59	<b>18</b>	<b>Caractéristiques techniques</b>	<b>75</b>
5.7	Régler la dureté de l'eau	59	<b>19</b>	<b>Mise au rebut</b>	<b>75</b>
<b>6</b>	<b>Préparer le café avec des grains</b>	<b>60</b>	<b>20</b>	<b>S'il vous faut faire appel au Service Après-Vente</b>	<b>75</b>
6.1	Conseils pour obtenir un café plus chaud	61			
<b>7</b>	<b>Préparer plusieurs tasses de café avec la fonction Verseuse</b>	<b>62</b>			
<b>8</b>	<b>Préparer le café avec du café moulu</b>	<b>63</b>			
<b>9</b>	<b>Faire mousser le lait</b>	<b>64</b>			
9.1	Nettoyer la buse à vapeur	65			

(F)

## 1 Légende des photos















### 1.1 Vue de face (Figure 1)

- A Grille-égouttoir
- B Verseuse isotherme
- C Interrupteur principal (dos de l'appareil)
- D Bloc distributeur de café réglable en hauteur
- E Panneau de commande (voir Figure 3)
- F Couvercle du conteneur de grains
- G Couvercle de l'entonnoir pour café moulu
- H Repose-tassechauffé
- J Tube pivotant pour vapeur et eau chaude
- K Buse à vapeur (amovible)
- L Élément intérieur de buse à vapeur (amovible)
- M Bouton d'ouverture du panneau de service
- N Réservoir d'eau avec repère Max (amovible)
- O Bac de récupération d'eau avec flotteur (amovible)

### 1.2 Vue de face avec panneau de service ouvert (Figure 2)

- P Panneau de service (ouvert)
- Q Bac à résidus (amovible)
- R Compartiment pivotant
- S Unité d'infusion
- T Bouton de réglage du degré de mouture
- U Conteneur de grains
- V Cuillère de dosage
- W Entonnoir de remplissage pour café prémoulu
- X Panneau signalétique (Dessous de l'appareil)
- Y Détartrant liquide
- Z Bâtonnet de test

## 1.3 Panneau de commande (Figure 3)

- a Bouton rotatif "Intensité d'arôme/ café prémoulu"
- b Bouton rotatif "Grandeur de tasse"
- c Ecran d'affichage
- d Touche "1 tasse de café"  Dans le mode Spécial, cette touche sert à "Feuilleter" ("<")
- e Touche "2 tasses de café"  Dans le mode Spécial, cette touche sert à "Feuilleter" (">")
- f Touche "vapeur"  Dans le mode Spécial, cette touche confirme le point de menu ("OK")
- g Touche „P” Dans le mode Spécial, cette touche fait revenir au niveau précédent sans entraîner la moindre modification ("P")
- h Touche "marche/arrêt" 
- j Sélecteur pour vapeur et eau chaude
- k Touche "Fonction carafe de café" 
- l Symboles "Café prémoulu"
- m Symboles "Carafe"
- n Symboles "Intensité d'arôme"
- o Symboles "Grandeur de tasse"
- p Symbole "Réservoir d'eau vide" 
- q Symbole "Détartrer" 
- r Symbole "Température de l'appareil" 
- s Symbole "Panneau de service ouvert" 
- t Symbole "Bac à résidus" 
- u Symbole "Attention" 
- v Symbole "Eau chaude" 
- w Symbole "Vapeur" 
- x Symbole "Préparation 2 tasses" 
- y Symbole "Préparation 1 tasse" 
- z Symboles pour le mode Spécial

## 2 Café et expresso

Cette fonction de votre machine à café automatique vous garantit un **manie-ment** très simple, pour la préparation du café, tout comme pour l'entretien. L'excellent **goût** individuel est obtenu par

- le système de pré-infusion: avant le processus d'infusion proprement dit, la mouture de café est humidifiée afin de dégager tout l'arôme possible,
- la quantité d'eau est réglable individuellement pour chaque tasse entre un expresso "court" et un café "long" avec de la crème,
- la température réglable individuellement à laquelle on porte le café à ébullition,
- la possibilité de choisir entre une tasse de café normal ou une tasse de café fort,
- le degré de mouture qui peut être adapté à la torréfaction des grains,
- et surtout la crème garantie, cette petite couronne de mousse qui rend le café expresso si incomparable pour les connaisseurs.

**Au fait:** Le temps de contact de l'eau avec la mouture de café est beaucoup plus court pour le café expresso que pour le café-filtre traditionnel. De ce fait, beaucoup moins de substances amères sont dégagées par la mouture de café, ce qui rend le café expresso nettement plus digest!

## 3 Consignes de sécurité



La sécurité de cet appareil est conforme aux règles reconnues de la technique et à la législation en vigueur en matière de sécurité des appareils. Néanmoins en qualité de fabricant, nous tenons à attirer votre attention sur les consignes de sécurité suivantes.

### Sécurité générale

- L'appareil ne doit être raccordé qu'à un réseau électrique dont la tension, le type de courant et la fréquence correspondent aux indications de la plaque signalétique figurant sous l'appareil!
- Toujours veiller à ce que le câble d'alimentation n'entre pas en contact avec des pièces chaudes de l'appareil.
- Ne jamais retirer la fiche de la prise de courant en tirant sur le cordon d'alimentation!
- Ne pas mettre l'appareil en service si:
  - le cordon d'alimentation est endommagé ou
  - le boîtier présente des dégâts visibles.
- N'insérer la fiche dans la prise de courant que lorsque l'appareil est éteint.
- Cet appareil n'est pas conçu pour être utilisé par des personnes (y compris des enfants) à capacités physiques, sensorielles ou mentales réduites ou qui manquent d'expérience et de connaissances, à moins qu'elles n'aient été initiées à son utilisation de la part d'une personne responsable de leur sécurité qui s'est assurée qu'elles en maîtrisent le maniement.

### Sécurité des enfants

- Ne laissez pas fonctionner l'appareil sans surveillance et soyez particulièrement vigilants avec les enfants!
- Le matériel d'emballage tels les sachets en plastique sont à tenir hors de portée des enfants.

F

### Sécurité pendant le fonctionnement

- Attention! Le bloc distributeur de café, la buse rotative et le repose-tasses deviennent bien entendu chauds pendant le fonctionnement. Tenir les enfants à distance!
- Attention! Risque de brûlures lorsque la buse de vapeur est en marche! Des éclaboussures d'eau chaude ou de la vapeur d'eau chaude peuvent provoquer des brûlures. Activez la buse à vapeur uniquement lorsque vous tenez un récipient sous la buse à vapeur.
- Ne réchauffez pas de liquides inflammables avec de la vapeur!
- L'appareil ne doit fonctionner que lorsqu'il y a de l'eau dans le système! Ne remplir le réservoir d'eau qu'avec de l'eau froide, pas avec de l'eau chaude, du lait ou d'autres liquides. Respecter la quantité maxi de remplissage de 1,8 litre.
- Ne mettez pas de grains de café congelés ou caramélisés dans le conteneur de grains, mais uniquement des grains de café torréfiés! Enlever les corps étrangers tels que, par ex., les petits cailloux du café en grains. Si le broyeur se bloque ou est endommagé à cause d'un corps étranger, ceci ne sera éventuellement pas couvert par la garantie.
- Mettre uniquement du café moulu dans l'entonnoir de remplissage de la poudre.
- Ne pas laisser l'appareil allumé inutilement.
- N'exposez pas l'appareil aux intempéries.
- En cas d'utilisation d'une rallonge, utilisez uniquement un cordon d'usage courant ayant une section de conducteur d'au moins 1,5 mm<sup>2</sup>.
- Les personnes atteintes de troubles moteurs ne doivent jamais mettre l'appareil en marche sans l'aide d'un accompagnateur pour éviter tout danger.

- L'appareil ne doit fonctionner que si le bac de récupération d'eau, le bac à résidus et la grille-égouttoir sont en place!

### Sécurité lors du nettoyage et de l'entretien

- Respecter les consignes de nettoyage et de détartrage.
- Avant l'entretien ou le nettoyage, éteindre l'appareil et retirer la fiche de la prise de courant!
- Ne plongez pas l'appareil dans l'eau.
- La buse à vapeur ne peut être nettoyée que lorsque l'appareil est éteint, froid et hors pression!
- Ne nettoyez pas les pièces de l'appareil dans le lave-vaisselle.
- Ne jamais verser d'eau dans le broyeur, car vous risquez de l'endommager.

N'ouvrez pas et ne tentez pas de réparer l'appareil. Des réparations non appropriées peuvent faire courir de graves dangers à l'utilisateur.

Les réparations sur les appareils électriques doivent être confiées exclusivement à un personnel qualifié.



Si une réparation s'avère nécessaire, ou s'il faut remplacer un cordon de raccordement, veuillez vous adresser



- au magasin dans lequel vous avez acheté l'appareil, ou
- appelez la Serviceline d'AEG/Electrolux.

Si l'appareil est détourné de son usage normal ou utilisé incorrectement, nous déclinons toute responsabilité en cas de dégâts éventuels et nous ne prenons pas en charge la garantie – ceci vaut également si le programme de détartrage n'a pas été effectué immédiatement après l'apparition du symbole  et selon les indications du présent mode d'emploi. Si le broyeur est bloqué ou endommagé à cause d'un corps étranger, ceci ne sera, éventuellement, pas couvert par la garantie.



## 4 Mode Spécial

Pour le réglage de la dureté de l'eau („Régler la dureté de l'eau" page 59) et la température du café („Régler la température du café" page 66), pour le démarrage du programme de détartrage („Lancer le programme de détartrage" page 69) et pour consulter les statistiques („Mode Statistique" page 73), commuter dans le mode Spécial en appuyant sur la touche "P" (Figure 4) dans le mode Spécial, les touches "1 tasse de café" , "2 tasses de café" , "Vapeur"  et „P" servent à la navigation. La fonction correspondante apparaît sur l'écran d'affichage, au-dessus de la touche (Figure 5):

- «<» ("1 tasse de café" ) et «>» ("2 tasses de café" ) permettent de faire défiler
- «OK» ("Vapeur" ) confirme un point
- «P» („P") fait revenir au niveau précédent sans entraîner la moindre modification

## 5 Première mise en service

### 5.1 Mettre l'appareil en place et le raccorder au secteur

Choisir une surface appropriée, horizontale, stable, non chauffée, sèche et hydrofuge.

-  Veillez à assurer une bonne circulation d'air. Sur les côtés et au dos de l'appareil, il faut réserver un espace libre d'au moins 5 cm, et au-dessus de l'appareil d'au moins 20 cm.

L'appareil ne doit pas être installé dans des pièces où la température peut atteindre 0°C ou moins (détérioration de l'appareil du fait de l'eau qui gèle).

-  Attention! Lorsque l'appareil est installé dans une pièce chaude après avoir été entreposé au froid, attendez environ 2 heures avant de le mettre en marche!

Nous recommandons de placer un support approprié sous l'appareil pour éviter les dégâts dus aux éclaboussures.

-  Brancher l'appareil uniquement sur une prise de courant reliée à la terre. Ne pas utiliser de prises de courant sans prise de terre.

### 5.2 Remplir d'eau

Avant chaque mise en marche, vérifiez la présence d'eau dans le réservoir d'eau; au besoin, faites l'appoint d'eau. Avant chaque mise en marche et chaque arrêt, l'appareil a besoin d'eau pour les processus de rinçage automatique.

-  Sortir le réservoir d'eau de l'appareil (Figure 6). Toujours faire pivoter la buse d'eau pour la ramener au centre de l'appareil avant de retirer le réservoir, sinon il vous sera impossible de l'enlever.

-  Remplissez le réservoir d'eau fraîche et froide. Ne versez jamais d'eau au-delà du repère MAX.

-  Remplir le réservoir d'eau uniquement avec de l'eau froide. Ne jamais y verser d'autres liquides tels que de l'eau minérale ou du lait.

-  Remettez le réservoir d'eau en place (Figure 6). Appuyer en même temps fermement sur le réservoir afin que le clapet du réservoir d'eau s'ouvre.

-  Pour toujours obtenir un café aromatique, vous devriez:

- changer tous les jours l'eau du réservoir d'eau,
- nettoyer le réservoir d'eau au moins une fois par semaine dans de l'eau de rinçage normale (pas dans le lave-vaisselle). Rincer ensuite à l'eau claire.

### 5.3 Remplir le conteneur de grains de café

-  Ouvrez le couvercle du conteneur de grains de café et remplissez-le de grains de café frais (Figure 7) Puis refermez le conteneur.

F



Attention! Ne pas mettre de grains de café congelés ou caramélisés dans le conteneur de grains, mais uniquement des grains de café torréfiés! Vérifiez qu'aucun corps étranger, comme par exemple des cailloux, n'a été introduit dans le conteneur de grains. Si le broyeur est bloqué ou endommagé à cause d'un corps étranger, ceci ne sera, éventuellement, pas couvert par la garantie.



Le broyeur est réglé d'usine sur un degré de mouture moyen. Si nécessaire, vous pouvez modifier ce réglage. Vous trouverez les instructions pour la modification de ce réglage sous „Régler le degré de mouture“ page 65.



Le degré de mouture ne doit être modifié que pendant le processus de broyage. Les réglages effectués sur le broyeur immobile peuvent endommager la machine à café.



La machine à café a été testée en usine. Pour ce faire, on a utilisé du café. Il est donc parfaitement normal que vous trouviez du café dans le broyeur. De toutes façons, cette machine à café est garantie livrée à l'état neuf.

#### 5.4 Première mise en service

Lors de la première mise en service de l'appareil, la machine à café doit être ventilée



Mettez l'appareil sous tension au moyen de l'interrupteur principal situé au dos de celui-ci (Figure 8).

Lors de la toute première utilisation du commutateur principal, tous les symboles s'allument pendant quelques secondes sur l'écran pour un autocontrôle, les symboles ☰ et △ clignotent ensuite.



Pour le remplissage du réservoir, voir „Remplir d'eau“ page 57.



Remettre le réservoir d'eau en place (Figure 6). Appuyer en même temps fermement sur le réservoir afin que le clapet du réservoir d'eau s'ouvre.



Faites pivoter la buse à vapeur vers l'extérieur et placez une tasse sous celle-ci (Figure 9).



Tourner le sélecteur de vapeur et d'eau chaude jusqu'en butée dans le sens inverse des aiguilles d'une montre pour l'amener dans la position ☰ (Figure 10).

Un peu d'eau s'écoule de la buse à vapeur. Les symboles ☰ et △ restent allumés en permanence.

Quand la tasse est remplie d'environ 30 ml d'eau, les symboles ☰ et △ se mettent à clignoter.



Tourner le sélecteur de vapeur et d'eau chaude jusqu'en butée dans le sens des aiguilles d'une montre pour l'amener dans la position ● (Figure 10) afin d'arrêter l'écoulement d'eau.

Le symbole ☰ clignote pendant quelques secondes et l'appareil s'éteint.



Pour remplir le conteneur de grains de café, voir „Remplir le conteneur de grains de café“ page 57.

#### 5.5 Mise en marche de l'appareil

Avant chaque mise en marche, vérifiez la présence d'eau dans le réservoir d'eau; au besoin, faites l'appoint d'eau. Avant chaque mise en marche et chaque arrêt, l'appareil a besoin d'eau pour les processus de rinçage automatique.



Mettez l'appareil sous tension à l'aide de la touche "marche/arrêt" ① (Figure 11).



Aussitôt après la mise en marche, le réglage de l'appareil est effectué. Les bruits que l'on entend alors sont parfaitement normaux.







Pendant le processus de chauffage (env. 120 secondes), le symbole ☰ clignote.

Pendant le chauffage, l'appareil procède à un rinçage automatique (un peu d'eau chaude s'écoule de l'écoulement de café et est capté dans le bac de récupération de l'eau).

Après l'achèvement du chauffage, le symbole  reste allumé en permanence. L'appareil est maintenant prêt à fonctionner. Le symbole allumé correspond au dernier réglage de café sélectionné.

### 5.6 Arrêter l'appareil

 Arrêtez l'appareil au moyen de la touche „marche/arrêt”  (Figure 11). Le symbole  clignote. L'appareil effectue une opération de rinçage puis s'arrête.

 Si l'appareil n'est pas utilisé pendant un certain laps de temps, il s'éteint automatiquement au bout de trois heures pour des raisons d'économie d'énergie.

 Si vous n'utilisez pas l'appareil pendant une période prolongée, vous devriez après l'avoir arrêté au moyen de la touche „marche/arrêt” également le mettre hors tension en actionnant l'interrupteur principal placé au dos de l'appareil (Figure 8).

### 5.7 Régler la dureté de l'eau

Après la première mise en service, ou en cas d'utilisation d'une autre qualité d'eau, vous devriez régler l'appareil en fonction du degré de dureté correspondant à la dureté de l'eau de l'endroit où vous trouvez. Utilisez le bâtonnet de test joint à l'appareil pour déterminer le degré de dureté, ou bien demandez le degré de dureté à votre service des eaux.

#### Détermination du degré de dureté de l'eau

 Plongez le bâtonnet de test pendant environ 1 seconde dans l'eau froide. Secouez-le pour le débarrasser de l'eau en excédent et déterminez le degré de dureté à l'aide des zones colorées en rose.

 **aucune ou une zone rose:**  
**degré de dureté 1, douce**  
jusqu'à 1,24 mmol/l, ou  
jusqu'à 7° de dureté (échelle allemande), ou  
jusqu'à 12,6° de dureté (échelle française)





 **deux zones roses:**  
**degré de dureté 2, dureté moyenne**  
jusqu'à 2,5 mmol/l, ou  
jusqu'à 14° de dureté (échelle allemande), ou  
jusqu'à 25,2° de dureté (échelle française)

 **trois zones roses:**  
**degré de dureté 3, dure (calcaire)**  
jusqu'à 3,7 mmol/l, ou  
jusqu'à 21° de dureté (échelle allemande), ou  
jusqu'à 37,8° de dureté (échelle française)

 **quatre zones roses:**  
**degré de dureté 4, très dure (calcaire)**  
plus de 3,7 mmol/l, ou  
plus de 21° de dureté (échelle allemande), ou plus de 37,8° de dureté (échelle française)

#### Réglage et sauvegarde du degré de dureté de l'eau mesuré





Vous pouvez régler quatre duretés d'eau. L'appareil est réglé en usine sur le degré de dureté 4.

 Pendant que l'appareil est allumé, appuyez sur la touche "P" (Figure 4). Les symboles "P" et  s'allument. En outre, les trois petits symboles au-dessus des touches ,  et , s'allument afin d'indiquer la fonction momentanée de ces touches, cf. „Mode Spécial” page 57.

 Confirmer la sélection avec la touche "OK" (Figure 5).

F

L'écran indique le réglage respectif. Les degrés de dureté sont indiqués comme ci-après:

-  Degré de dureté 1
-  Degré de dureté 2
-  Degré de dureté 3
-  Degré de dureté 4

 Appuyez ensuite sur la touche de défilement "<" ou ">" (Figure 5) autant de fois qu'il le faut jusqu'à faire apparaître le degré de dureté mesuré auparavant.

 Validez votre sélection au moyen de la touche "OK" (Figure 5). Ce degré de dureté est maintenant mis en mémoire.

 Pour interrompre sans mettre en mémoire, appuyer sur "P" à la place de "OK".

Si la touche „OK" n'est pas actionnée au bout d'environ 120 secondes, l'appareil repasse automatiquement au mode Café, sans que les données sélectionnées soient mémorisées.

 Pour revenir au mode Café, appuyez alors sur la touche "P" (Figure 4) ou attendez environ 120 secondes jusqu'à ce que l'appareil revienne automatiquement au mode Café.

## 6 Préparer le café avec des grains

Le processus ci-après de préparation du café en grains fonctionne entièrement automatiquement: Moudre, fractionner, comprimer, pré-infuser, infuser et éjecter le marc de café.

Ayant la possibilité de choisir le degré et la quantité de mouture, vous pouvez régler l'appareil en fonction de vos goûts personnels.





 Ne pas mettre de grains de café congelés ou caramélisés dans le conteneur de grains, mais uniquement des grains de café torréfiés! Vérifiez qu'aucun corps étranger, comme par exemple des cailloux, n'a été introduit dans le conteneur de grains. Si le broyeur est bloqué ou endommagé à cause d'un

**corps étranger, ceci ne sera, éventuellement, pas couvert par la garantie.**

Choisissez suivant votre goût un espresso "court" ou bien un café "long" avec crème.

 Choisissez la grandeur de tasse souhaitée à l'aide du bouton rotatif „Grandeur de tasse" (Figure 12). La grandeur de tasse sélectionnée est affichée.





 Les tailles de tasse sont indiquées comme ci-après:

-  Tasse à espresso
-  Petite tasse
-  Tasse moyenne
-  Grande tasse
-  Gobelet



Vous pouvez choisir un café extra-léger, léger, normal, fort ou extra-fort.



 Sélectionnez l'intensité d'arôme souhaitée au moyen du bouton rotatif „Intensité d'arôme" (Fig 13). L'intensité sélectionnée est affichée.

 L'intensité est indiquée comme ci-après:

-  Extra doux
-  Doux
-  Normal
-  Fort
-  Extra fort

 Mettez une ou deux tasses sous le bloc distributeur de café (Figure 14). En remontant ou en abaissant le bloc distributeur, vous pouvez adapter de manière optimale la hauteur d'écoulement à la hauteur de votre tasse, afin de réduire les pertes de chaleur et les éclaboussures de café (Figure 15).

 Appuyez sur la touche "1 tasse de café"  pour obtenir une tasse, ou bien sur la touche „2 tasses"  pour obtenir 2 tasses.

Le symbole "1 tasse"  ou "2 tasses"  s'allume. L'appareil mout alors les grains. Lors de la préparation du café, la poudre de café est d'abord humectée avec une faible quantité d'eau pour la porter à ébullition une première fois.

Après une brève interruption, le processus d'infusion proprement dit est lancé. Le café se déverse dans la tasse.

Une fois que la quantité de café souhaitée est versée, l'appareil arrête automatiquement le versement et déverse la poudre de café utilisée dans le bac à résidus. Pendant ce temps, le symbole "1 tasse" ☐ ou "2 tasses" ☐ clignote.

☞ Vous pouvez à tout moment interrompre prématurément l'écoulement du café en appuyant brièvement sur la touche "1 tasse" ☐ ou "2 tasses" ☐, ou en tournant le bouton rotatif „Grandeur de tasse" (Figure 12) dans le sens inverse des aiguilles d'une montre en direction „Tasse expresso".

☞ Dès que le café a cessé de s'écouler, vous pouvez augmenter la quantité de café en appuyant sur la touche „1 Tasse" ☐ ou "2 tasses" ☐ et en la maintenant enfoncée jusqu'à ce que la quantité de café souhaitée soit atteinte ou en faisant tourner le bouton tournant "Grandeur de tasse" (Figure 12) dans le sens des aiguilles d'une montre en direction de "Gobelet" (ceci doit se faire immédiatement après que le café a été versé et avant que la poudre de café consommée ne soit déversée dans le bac à résidus).

Quelques secondes plus tard, quand le symbole "1 tasse" ☐ ou "2 tasses" ☐ s'éteint, l'appareil est de nouveau prêt à être utilisé et vous pouvez préparer la tasse de café suivante.

**i** Si le café ne s'écoule que goutte à goutte ou ne s'écoule pas entièrement, ou encore s'il sort trop vite et que la crème n'est pas à votre goût, vous devriez modifier le degré de mouture, voir „Régler le degré de mouture" page 65

**i** Si les symboles ☐ et ☐ clignotent, le café est moulu trop finement. Modifier le réglage du degré de mouture, voir „Régler le degré de mouture" page 65.

**i** Si le symbole ☐ s'allume, vous devrez alors remplir le réservoir d'eau, car sinon l'appareil ne peut pas préparer de café. (Il est normal qu'un peu d'eau reste dans le réservoir d'eau lorsque le symbole est affiché.)

**i** Si le symbole ☐ s'allume, cela veut dire que le bac à résidus est plein et qu'il doit être vidé et nettoyé, voir „Vider le bac à résidus" page 67. Aussi longtemps que le bac à résidus n'est pas nettoyé, le symbole reste allumé et la machine à café ne peut pas préparer le café.

**i** Ne jamais sortir le réservoir d'eau pendant que du café s'écoule de la machine. Si celui-ci a été retiré, la machine à café ne peut plus préparer de café. Pour purger l'air de la machine à café, veuillez tourner le bouton rotatif de commande de la vapeur et de l'eau chaude le plus possible dans le sens des aiguilles d'une montre pour l'amener dans la position ☐ et laisser de l'eau s'écouler de la buse à vapeur pendant quelques secondes.

**i** Lors de la première mise en service de la machine à café, vous devrez préparer au moins 4-5 cafés avant que la machine fournisse un résultat satisfaisant.



## 6.1 Conseils pour obtenir un café plus chaud

- Lorsque vous venez de démarrer la machine à café et que vous souhaitez préparer une petite tasse (moins de 60 ml), utilisez l'eau chaude provenant du rinçage pour réchauffer les tasses.
- Sélectionnez une température de café plus élevée, voir „Régler la température du café" page 66.
- N'utilisez pas de tasses trop épaisses lorsque vous les réchauffez, car elles absorbent trop la chaleur.
- Pour réchauffer les tasses, rincez-les à l'eau chaude ou placez-les pendant au moins 20 minutes sur le repose-tasse chauffé (H) de la machine à café en marche.

F





## 7 Préparer plusieurs tasses de café avec la fonction Verseuse

Avec cette fonction, vous pouvez préparer automatiquement **plusieurs tasses de café dans la verseuse isotherme en acier inox** fournie avec la machine à café: Moudre, fractionner, comprimer, pré-infuser, infuser et éjecter le marc de café comme indiqué à la section précédente.

-  Tournez le couvercle de la verseuse en acier inox fournie avec la machine et placez-le en position de dépose (Figure 16). Déposez le couvercle. Rincez la verseuse et le couvercle.
-  Placez le couvercle en position «verser» (Figure 17) sur la verseuse isotherme et placez celle-ci sous le bloc distributeur de café (D). Le bloc distributeur de café doit être remonté tout en haut afin que la verseuse isotherme puisse être mise en place.

L'un des symboles pour les fonctions Carafe s'allume en fonction du nombre de tasses qui a été sélectionné lors de la dernière utilisation de la fonction Carafe. En outre, les symboles Feuilletter "<" et ">" s'allument.





Le nombre de tasses que l'on peut verser dans la carafe est indiqué comme ci-après:

-  4 tasses
-  6 tasses
-  8 tasses
-  10 tasses

-  Assurez-vous que le réservoir d'eau est plein, qu'il y a suffisamment de grains dans le conteneur de grains et que le bac à résidus est vide afin de pouvoir préparer toute une série de cafés dans la verseuse.

-  Si vous voulez modifier l'intensité d'arôme et le volume de remplissage pour la fonction «Verseuse», utiliser le bouton tournant "Grandeur de tasse" (Figure 12) ou le bouton tournant

"Intensité d'arôme" (Figure 13) comme décrit à la section „Préparer le café avec des grains" page 60.

-  Choisir le cas échéant, avec les touches Feuilletter "<" ou ">", le symbole correspondant au nombre de tasses à préparer dans la verseuse, par ex.  pour 8 tasses.
-  Appuyer sur la touche „Carafe"  (Figure 18).



Pendant la préparation du café, le symbole de carafe clignote pour le nombre de tasses choisi.

Quand le processus d'ébullition est achevé, tous les symboles de carafe clignotent par alternance, le symbole pour le nombre de tasses choisi restant allumé deux fois plus longtemps que les autres symboles.

-  Retirez maintenant la verseuse isotherme et fermez le couvercle (Figure 19) pour garder le café chaud pendant longtemps.

L'appareil revient automatiquement en mode Café.





-  Si, selon les cas, trop peu de café en grains a été rempli ou trop peu d'eau se trouve dans le réservoir d'eau pour permettre de mener à bonne fin la fonction souhaitée ou si le bac à marc est plein, l'appareil interrompt le processus et le programme en cours est arrêté. Une fois le défaut éliminé, le programme doit être redémarré. La quantité de café qui se trouve déjà dans la verseuse doit alors être prise en compte afin que la verseuse ne déborde pas.

-  Si le symbole  et  clignote, cela signifie que la poudre de café est moulue trop finement. Modifier le réglage du degré de mouture, voir „Régler le degré de mouture" page 65.



## 8 Préparer le café avec du café moulu

Avec cette fonction, vous pouvez faire infuser du café déjà moulu, par ex. **du café décaféiné**.

 Attention! Vérifiez qu'aucune poudre n'est restée coincée dans l'entonnoir, et qu'aucun corps étranger ne pénètre dans l'entonnoir. L'entonnoir de remplissage n'est pas un réservoir: la poudre doit parvenir directement dans l'unité d'infusion.

 Tournez le bouton rotatif "Intensité d'arôme / café prémoulu" (Figure 20) dans la position voulue  (pour 1 tasse) ou  (pour 2 tasses) afin de sélectionner la fonction Café moulu. Un symbole  (pour 1 tasse) ou deux symboles  (pour 2 tasses) s'allument.

 Ouvrez le couvercle de l'entonnoir de café moulu, remplissez avec du café moulu frais (Figure 21).

Utilisez seulement la cuillère de dosage fournie avec la machine. Ne versez jamais plus que 2 cuillères de dosage remplies à ras car sinon, soit la machine ne préparera aucun café, soit la poudre de café sera éparpillée dans la machine et l'encrassera, soit le café sortira au goutte à goutte et les symboles  et  clignotent.

Ne versez pas de café moulu dans la machine pendant le processus d'infusion. Ne versez le café moulu pour la tasse suivante que lorsque le processus d'infusion est entièrement achevé et que l'appareil est prêt. Ne versez jamais de café moulu dans la machine lorsque celle-ci est éteinte, car sinon ce café moulu sera éparpillé à l'intérieur de la machine.



 N'utilisez que du café moulu pour machines à espresso entièrement automatiques. Ne versez pas dans l'entonnoir des grains de café, des produits instantanés solubles dans l'eau ou lyophilisés, ni aucune autre poudre pour

boisson. Les cafés moulus trop fin risquent d'obstruer la machine.







 Si l'entonnoir de remplissage est obstrué (suite à de l'humidité dans la machine ou parce que l'on a introduit plus de 2 cuillères de dosage de café moulu), utilisez un couteau ou un manche de cuillère pour repousser le café moulu vers le bas (Figure 22). Retirer ensuite l'unité d'infusion et la nettoyer ainsi que la machine à café comme indiqué sous „Nettoyer l'unité d'infusion" page 68".

 Refermez le couvercle.

 Sélectionnez la grandeur de tasse souhaitée à l'aide du bouton rotatif „Grandeur de tasse" (Figure 12) comme décrit à la section „Préparer le café avec des grains" page 60.

 Appuyez sur la touche "1 tasse de café"  pour préparer une tasse de café ou la touche „2 tasses"  pour préparer 2 tasses.

Le café est préparé.

 Si l'on a choisi la fonction pour poudre de café prémoulu pour une 1 tasse et qu'aucune poudre de café n'a été remplie dans l'entonnoir de café moulu, les symboles  et  se mettent à clignoter après que l'on a appuyé sur la touche . Si la fonction pour poudre de café prémoulu pour deux tasses a été choisie et qu'aucune poudre de café n'a été remplie dans l'entonnoir de café moulu, les symboles  et  se mettent à clignoter après que l'on a appuyé sur la touche .

 Pour revenir au mode Grains de café après la préparation du café, tournez le bouton rotatif "Intensité d'arôme/ café prémoulu" (Figure 20) sur une intensité d'arôme quelconque (le broyeur va alors pouvoir fonctionner de nouveau).

F



## 9 Faire mousser le lait

La vapeur peut être utilisée pour faire mousser le lait et pour réchauffer des liquides. Étant donné que la production de vapeur nécessite une température plus élevée que la préparation du café, l'appareil dispose d'un mode vapeur supplémentaire.

-  Pour un cappuccino, remplissez la moitié ou les 2/3 d'une grande tasse avec de l'expresso, puis rajoutez le lait mousseux.



-  **Attention!** Risque de brûlures lorsque la buse de vapeur est en marche! Des éclaboussures d'eau chaude ou de la vapeur d'eau chaude peuvent provoquer des brûlures. C'est pourquoi vous ne devez actionner la buse de vapeur qu'une fois qu'elle est plongée dans le lait.

-  Pour préparer la vapeur, appuyez sur la touche "Vapeur" (Figure 23).

Le symbole  s'allume et l'appareil se met à chauffer. Pendant l'échauffement, le symbole  clignote.

Après l'achèvement du processus de chauffage, le symbole  reste allumé en permanence. L'appareil est prêt à faire mousser le lait.

-  Si la fonction vapeur n'est pas utilisée pendant plus de 2 minutes, l'appareil repasse automatiquement en mode de préparation du café.



-  Afin d'éviter qu'un reste d'eau se mélange avec le lait lors du processus de moussage, vous devriez d'abord évacuer l'eau. Pour ce faire, placez un récipient sous la buse de vapeur et maintenez le sélecteur rotatif de commande de la vapeur et de l'eau chaude (Figure 10) dans la position  jusqu'à ce que de la vapeur apparaisse. Remplacez alors le bouton rotatif dans la position .

-  Mettez du lait froid écrémé dans un gobelet qui doit passer sous la buse à vapeur de l'appareil.

-  Le lait doit être bien refroidi. Par ailleurs, vous devriez utiliser un récipient froid, de préférence un gobelet en acier inoxydable, et ne pas l'avoir rincé à l'eau chaude auparavant.



-  Faites pivoter la buse vapeur vers l'extérieur et tenez le gobelet sous la buse à vapeur, de manière à ce que l'orifice de la buse soit tout juste immergé dans le lait (Figure 24).

-  **Attention!** Risque de salissures dues au lait séché dans la buse à vapeur. Veillez à ce que la buse à vapeur ne soit pas plongée trop profondément dans le lait afin que l'orifice d'aspiration d'air à l'extrémité supérieure de la buse à vapeur ne soit pas recouvert par le lait. Sinon le lait peut être aspiré dans la buse et provoquer éventuellement des salissures de la buse à vapeur.

-  Amenez le sélecteur de vapeur et d'eau chaude (Figure 10) sur la position . Le lait est rendu mousseux.

-  Pour obtenir un lait mousseux plus crémeux, déplacez lentement le récipient de bas en haut. Faites mousser le lait au moins jusqu'à ce qu'il double de volume.

-  Il est recommandé de ne pas prélever de la vapeur pendant plus de 2 minutes sans interruption.

-  Pour arrêter le processus de moussage, placez le sélecteur de vapeur et d'eau chaude (Figure 10) sur la pos.  et retirez ensuite le récipient.



-  **Attention!** Risque de brûlures causées par les éclaboussures de lait chaud! Arrêtez la vapeur avant de retirer le pichet contenant le lait mousseux.

-  Quittez le mode Vapeur en appuyant sur la touche „Vapeur" (Figure 23) ou attendez environ 120 secondes jusqu'à ce que l'appareil revienne automatiquement en mode Café.

L'appareil est de nouveau prêt pour la préparation de café.

-  Laissez dans tous les cas encore un peu d'eau chaude s'échapper de la buse









après avoir fait mousser le lait en amenant le sélecteur de vapeur et d'eau chaude (Figure 10) sur la position . Cela est nécessaire pour que les restes de lait à l'intérieur de la buse ne sèchent pas, ce qui risquerait d'obstruer la buse. Utilisez à cette fin un récipient collecteur approprié. Pendant le processus, le symbole  s'allume.

-  Remplacez ensuite le bouton rotatif de vapeur et eau chaude sur la pos. ●. A l'écran, le réglage de café effectué en dernier est affiché.







### 9.1 Nettoyer la buse à vapeur

**Important:** Pour des raisons d'hygiène, il est recommandé d'effectuer l'opération décrite ci-après à chaque fois que vous avez fait mousser du lait. Vous évitez ainsi que du lait se dépose à l'intérieur de la buse à vapeur.

-  Tournez le bouton de commande de la vapeur et de l'eau chaude dans le sens des aiguilles d'une montre jusqu'en butée le plaçant ainsi dans la pos. ●. Attendez quelques minutes jusqu'à ce que la buse à vapeur se soit refroidie.
-  Saisissez alors le tube pivotant par la poignée noire et ouvrez la fermeture à baïonnette de la buse à vapeur en tournant légèrement dans le sens des aiguilles d'une montre. Retirez la buse à vapeur par le bas (Figure 25).
-  Retirez l'élément intérieur de la buse à vapeur du tube pivotant en tirant vers le bas.
-  Nettoyez la buse à vapeur et l'élément intérieur avec de l'eau chaude.
-  Assurez-vous que les deux trous indiqués sur la figure 26 ne sont pas colmatés. Le cas échéant, y faire passer une aiguille et les nettoyer ainsi.
-  Remontez l'élément intérieur en le faisant glisser avec précaution sur le tube pivotant.
-  Remontez la buse à vapeur en la glissant et tournez dans le sens inverse des aiguilles d'une montre.



## 10 Préparation d'eau chaude

L'eau chaude peut être utilisée pour préchauffer les tasses et pour préparer des boissons chaudes, comme par exemple du thé, une tisane ou des potages instantanés.

-  Attention! Risque de brûlures lorsque la buse d'eau chaude est en marche! Les éclaboussures d'eau chaude peuvent provoquer des brûlures. Activez la buse à eau chaude uniquement lorsqu'un récipient est placé sous celle-ci.
-  Posez un récipient sous la buse à eau chaude.
-  Placez le sélecteur rotatif de vapeur et d'eau chaude sur la position  (Figure 10). De l'eau chaude s'écoule alors de la buse; le symbole  s'allume.
-  Il est recommandé de ne pas prélever d'eau chaude pendant plus de 2 minutes sans interruption.
-  Après avoir prélevé de l'eau chaude, remplacez le bouton rotatif de vapeur et d'eau chaude sur la position ● (Figure 10) et enlevez le récipient.

## 11 Régler le degré de mouture

Le broyeur est réglé d'usine sur un degré de mouture moyen. Si le café passe trop rapidement ou trop lentement (au goutte à goutte), vous pouvez modifier le degré de mouture pendant l'opération de broyage.

-  Il n'est permis de modifier le degré de mouture que pendant le processus de mouture, c.-à-d. que le bouton pour le réglage du degré de mouture (Figure 2, T et Figure 27) ne peut être tourné que tant que le broyeur mout du café en grains pendant une préparation de café. Les réglages effectués sur le broyeur immobile peuvent endommager la machine à café.
-  Réglez le degré de mouture à l'aide du bouton de réglage du degré de mouture (Figure 2, T) (Figure 27).

F

- Si le café ne s'écoule que goutte à goutte ou pas du tout (il est possible que les symboles ☰ et △ clignotent), le bouton doit être tourné d'un cran dans le sens des aiguilles d'une montre.

Tournez d'un cran à la fois jusqu'à ce que le café s'écoule de façon satisfaisante.

- Si le café s'écoule trop rapidement ou si la crème n'est pas à votre goût, tournez le bouton d'un cran dans le sens inverse des aiguilles d'une montre.

**i** Veillez bien à ne pas trop tourner le bouton de réglage du degré de mouture car sinon le café risque de ne sortir qu'au goutte à goutte lorsque vous demanderez la préparation de 2 cafés.

**i** Notez bien que vous ne remarquerez l'effet de ces corrections qu'après au moins les 2 préparations de café suivantes.

#### Retirer un corps étranger du broyeur

Les corps étrangers, tels que les petits cailloux peuvent endommager le broyeur. Lorsqu'il y a un corps étranger dans le café, cela produit un cognement caractéristique. Si vous entendez un tel bruit pendant le fonctionnement du broyeur, vous devriez arrêter l'appareil immédiatement et vous adresser au SAV. **Si le broyeur se bloque ou est endommagé à cause d'un corps étranger, ceci ne sera éventuellement pas couvert par la garantie.**

## 12 Régler la température du café

Vous avez le choix entre trois niveaux de température. Le réglage d'usine est «Température élevée». Vous pouvez le modifier comme suit:

- ☞ Appuyez sur la touche "P" (Figure 4). Les symboles "P" et ☰ s'allument. En outre, les trois petits symboles au-dessus des touches ☐, ☐ et ☐, s'allument afin d'indiquer la fonction

momentanée de ces touches, cf. „Mode Spécial" page 57.

- ☞ Appuyez autant de fois que nécessaire sur les touches Feuilletter "<" ou ">" (Figure 5) jusqu'à ce que le symbole ☐ s'allume.

- ☞ Confirmez l'option au moyen de la touche "OK" (Figure 5).

L'écran affiche le réglage respectif. Les températures sont affichées comme ci-après:

- ☐ Température basse
- ☐ ☐ Température moyenne
- ☐ ☐ ☐ Température élevée

- ☞ Choisissez le cas échéant une autre température au moyen de la touche "<" ou ">" (Figure 5).

- ☞ Lorsque la température souhaitée est affichée, validez celle-ci en actionnant la touche "OK" (Figure 5). Cette température est alors programmée.

**i** Pour interrompre sans mettre en mémoire, appuyez sur "P" au lieu de "OK".

**i** Si la touche „OK" n'est pas actionnée, l'appareil repasse automatiquement au mode Café après environ 120 secondes, sans que les nouveaux réglages soient mémorisés.









- ☞ Pour revenir au mode Café, appuyez ensuite sur la touche "P" (Figure 4) ou attendez environ 120 secondes jusqu'à ce que l'appareil repasse automatiquement au mode Café.

## 13 Nettoyage et entretien

Maintenez toujours l'appareil en parfait état de propreté afin d'obtenir une qualité de café constante et un fonctionnement impeccable.

### 13.1 Nettoyage régulier





- ⚠ **Attention!** Éteignez l'appareil avant le nettoyage. Laissez l'appareil se refroidir.

-  **Attention!** Ne mettez jamais l'appareil ou certaines de ses pièces dans un lave-vaisselle. Ne plongez jamais la machine à café dans l'eau.
-  **Attention!** Ne versez jamais d'eau dans le conteneur de grains de café, car cela endommagerait le broyeur.
-  N'utilisez aucun produit à récuser, corrosif ou décapant. Utilisez exclusivement un chiffon humide pour nettoyer l'intérieur et l'extérieur du boîtier.
-  Retirez tous les jours le réservoir d'eau (Figure 6) et jetez le reste de l'eau. Nettoyez le réservoir d'eau avec de l'eau fraîche. Utilisez tous les jours de l'eau fraîche.
-  Videz le bac à résidus chaque jour ou au plus tard lorsqu'un message s'affichant à l'écran vous y invite, voir „Vider le bac à résidus“ page 67.
-  Videz régulièrement le bac de récupération d'eau. Mais faites-le au plus tard quand le flotteur rouge du bac de récupération d'eau (Figure 28) apparaît dans l'ouverture de la grille-égouttoir.
-  Nettoyez régulièrement, au moins une fois par semaine, réservoir d'eau (N), bac de récupération d'eau (O), grille-égouttoir (A) et bac à résidus (Q) avec de l'eau chaude, un produit pour vaisselle non agressif et éventuellement un pinceau.
-  Après chaque moussage du lait, retirez la buse à vapeur et débarrassez-la de tous résidus de lait, voir „Nettoyer la buse à vapeur“ page 65.
-  Assurez-vous que les orifices du bloc distributeur de café ne sont pas colmatés. Pour les nettoyer, vous pouvez retirer le café séché à l'aide d'une aiguille (Figure 29).



### 13.2 Vider le bac à résidus

L'appareil compte le nombre de cafés préparés. Après la préparation de 14 tasses individuelles (ou de 7 en paire), le symbole  s'allume pour signaler que le bac à résidus est plein et doit être vidé ainsi que nettoyé. Aussi long-

temps que le bac à résidus n'est pas nettoyé, la machine ne peut pas préparer de café.



-  Pour effectuer le nettoyage, déverrouiller le panneau de service en appuyant sur le bouton d'ouverture correspondant et l'ouvrir (Figure 30), le symbole  s'allume.
-  Puis retirer le bac de récupération d'eau (Figure 31), le vider et le nettoyer.
-  Videz et nettoyez soigneusement le bac à résidus. Veillez à ce que tous les résidus s'étant déposés au fond soient bien éliminés.

**Important:** A chaque fois que vous retirez le bac de récupération d'eau, il faut également vider le bac à résidus, même si celui-ci n'est pas tout à fait plein. Si l'on omet de le faire, il peut arriver que, lors des préparations de café suivantes, le bac à résidus déborde et que le marc de café en excédent colmate la machine à café.

-  Une fois le bac de récupération enlevé, le symbole  se met à clignoter.
-  D'une façon générale, videz le bac à résidus tous les jours en cas d'usage quotidien de l'appareil. Videz toujours le bac à résidus pendant que l'appareil est allumé. Ce n'est qu'ainsi que l'appareil peut reconnaître que le bac a été vidé.

### 13.3 Nettoyer le broyeur

Vous pouvez retirer les résidus de café moulu se trouvant encore dans le conteneur de grains à l'aide d'un pinceau doux ou d'un aspirateur.

-  **Attention!** Ne mettez jamais d'eau dans le broyeur en raison des risques de détérioration de l'appareil.
-  Allumer l'appareil à l'aide de la touche "marche/arrêt" (Figure 11) et enclencher l'interrupteur principal (Figure 8). Débranchez la fiche de la prise de courant.

F

➡ Enlevez les restes de café en grains (utilisez par ex. un aspirateur avec un tuyau ou une buse plate).

**i** Si vous ne parvenez pas à retirer un corps étranger, veuillez vous adresser au Service Après-Vente. **Si le broyeur se bloque ou est endommagé à cause d'un corps étranger, ceci ne sera éventuellement pas couvert par la garantie.**

**!** **Attention!** Risque de blessure pendant que le broyeur tourne. Ne mettez jamais l'appareil en marche lorsque vous travaillez sur le broyeur. Cela pourrait occasionner de très graves blessures. Retirez obligatoirement la fiche de la prise de courant.

➡ Testez maintenant le fonctionnement du broyeur avec un petite quantité de grains en préparant un café. Lors de la première mouture ou après le nettoyage, seule une petite quantité de café moulu va pénétrer dans l'unité d'infusion, car le canal doit être rempli. Cela peut exercer une influence sur le premier café.

### 13.4 Nettoyer l'unité d'infusion

Nous vous conseillons de nettoyer l'unité d'infusion régulièrement (selon l'intensité d'usage). Si vous n'utilisez pas l'appareil pendant un certain temps (vacances, par exemple), il conviendra de vider le bac à résidus et le réservoir d'eau, et de nettoyer l'appareil à fond, y compris l'unité d'infusion. Procédez comme suit:

➡ Arrêter la machine à café en appuyant sur la touche marche/arrêt (Figure 11) (ne pas débrancher la fiche de la prise) et attendre que tous les symboles se soient éteints!

➡ Déverrouiller le panneau de service en appuyant sur le bouton d'ouverture correspondant et ouvrir celui-ci (Figure 30).

➡ Retirer le bac de récupération d'eau et le bac à résidus (Figure 31) et les nettoyer.

➡ Presser vers le centre les deux touches rouges de déverrouillage de l'unité d'infusion placées sur le côté (Figure 32) et retirer l'unité d'infusion.

**i** **Attention: L'unité d'infusion ne peut être retirée que lorsque l'appareil a été arrêté au moyen de la touche marche/arrêt ① se trouvant sur la face avant de l'appareil. L'appareil ne doit pas être débranché de la prise secteur. Si vous essayez de retirer l'unité d'infusion alors que la machine est en marche, celle-ci pourrait être sérieusement endommagée.**

➡ Nettoyer l'unité d'infusion sans utiliser de produit lave vaisselle, uniquement en la tenant sous le jet d'eau du robinet. **Ne jamais nettoyer l'unité d'infusion dans le lave-vaisselle.**

➡ Nettoyer soigneusement l'intérieur de la machine. Éliminer les incrustations de café à l'aide d'une fourchette en bois ou en plastique ou de tout objet semblable ne grattant pas et n'abîmant pas la surface (Figure 33) puis éliminer tous les résidus à l'aide d'un aspirateur (Figure 34).

➡ Pour remettre l'unité d'infusion en place (figure 36, a), l'introduire dans son support (Figure 36, b) et faire rentrer le goujon (Figure 36, c). Le goujon doit être introduit dans le tube (Figure 36, d) se trouvant à la partie inférieure de l'unité d'infusion.

➡ Appuyez maintenant fermement sur l'inscription PUSH (Figure 36, e) jusqu'à ce que l'unité d'infusion s'enclipsse avec un bruit caractéristique.

➡ Après avoir perçu le dé clic indiquant que l'unité est bien en place, assurez-vous que les touches rouges (Figure 36, f) sont bien ressorties, car sinon le panneau de service ne pourra pas être refermé.

Figure 37: Les deux touches rouges sont bien ressorties.

Figure 38: Les deux touches rouges ne sont pas ressorties.

☞ Remettez le bac de récupération d'eau ainsi que le bac à résidus en place.

☞ Refermez le panneau de service.

**i** Vous ne pourrez pas refermer le panneau de service si l'unité d'infusion n'a pas été remise en place correctement, c.-à-d. que l'on n'a pas entendu le déclic indiquant qu'elle est bien enclipsée et que les touches rouges ne sont pas sorties comme il se doit.

**i** S'il s'avère difficile de remettre l'unité d'infusion en place, c'est que celle-ci doit être ramenée à la hauteur qu'il faut (avant sa mise en place). Pour ce faire, la comprimer fermement à partir du haut et du bas comme indiqué sur la figure 35.

**i** S'il est toujours difficile de remettre l'unité d'infusion en place, refermez le panneau de service, débranchez la fiche du cordon de branchement de la prise et rebranchez-la.

Attendez que tous les symboles se soient éteints et ouvrez alors le panneau de service, puis remettez l'unité d'infusion en place.

### 13.5 Lancer le programme de détartrage





Le programme de détartrage permet un détartrage simple et efficace de votre appareil. Lorsque le symbole  allumé vous le signale, il faut détartrer l'appareil.

**!** **Attention:** N'employez en aucun cas des produits détartrants autres que ceux préconisés par AEG/Electrolux. Si vous employez d'autres détartrants, AEG/Electrolux décline toute responsabilité en cas de détériorations de votre appareil. Vous trouverez du détartrant liquide dans les magasins spécialisés ou en vous adressant à la Serviceline AEG/Electrolux.



**i** Le processus de détartrage dure environ 45 minutes et ne doit pas être interrompu. En cas de panne de

courant, le programme doit être redémarré à zéro.

☞ Avant de lancer le programme de détartrage, nettoyez l'unité d'infusion (voir „Nettoyer l'unité d'infusion" page 68).

☞ Appuyez sur la touche "P" (Figure 4). Les symboles "P" et  s'allument. En outre, les trois petits symboles au-dessus des touches ,  et , s'allument afin d'indiquer la fonction momentanée de ces touches, cf. „Mode Spécial" page 57.

☞ Appuyer autant de fois que nécessaire sur les touches Feuilletter "<" ou ">" (Figure 5) jusqu'à ce que le symbole  s'allume.

☞ Validez l'option en actionnant la touche "OK" (Figure 5). Les symboles ,  clignotent et "P" reste allumé en permanence.



**i** Pour interrompre à ce moment-là le programme de détartrage, arrêter l'appareil avec la touche "Marche/Arrêt"  (Figure 11).

☞ Vider le réservoir d'eau, y verser au moins 1 litre d'eau et ajouter le détartrant.

**!** **Attention:** Evitez les éclaboussures de détartrant sur toutes les surfaces sensibles à l'acide telles le marbre, les pierres calcaires et la céramique.

☞ Placer un récipient pouvant contenir au moins 1,5 litre sous la buse à vapeur (Figure 9)

☞ Placer le sélecteur de vapeur et d'eau chaude sur la position .

Le programme de détartrage commence et le liquide détartrant sort de la buse à vapeur. Les symboles ,  et "P" restent allumés en permanence.

Le programme de détartrage effectue automatiquement une série de rinçages entrecoupés de pauses visant à éliminer les dépôts de calcaire à l'intérieur de la machine à café.

F

Au bout d'une trentaine de minutes, le réservoir d'eau est vide et les symboles ☰ et △ clignotent et "P" reste allumé en permanence.

- ☞ Replacer le sélecteur de vapeur et d'eau chaude sur la position ●.

L'appareil est maintenant prêt pour le rinçage à l'eau fraîche.

- ☞ Retirer le réservoir d'eau, le remplir d'eau fraîche et le remettre en place.
- ☞ Vider le récipient se trouvant sous la buse de vapeur et le replacer sous la buse de vapeur.
- ☞ Placer le sélecteur de vapeur et d'eau chaude sur la position ☰.

Un rinçage à l'eau fraîche est exécuté et l'eau de rinçage s'écoule de la buse à vapeur. Les symboles ☰, △ et "P" restent allumés en permanence.

Au bout de quelques minutes, le réservoir d'eau est vide et les symboles ☰ et △ clignotent et "P" reste allumé en permanence.

- ☞ Replacer le sélecteur de vapeur et d'eau chaude sur la position ●.
- Les symboles correspondants au mode Café choisi en dernier lieu sont affichés et le symbole ☰ reste allumé en permanence.
- ☞ Vider le réservoir avec l'eau de rinçage.
- ☞ Retirer le réservoir d'eau, le remplir d'eau fraîche et le remettre en place. L'appareil est maintenant prêt à fonctionner à nouveau et se trouve dans le dernier mode de préparation de café sélectionné.

- i** Après l'exécution du programme de détartrage, nous vous conseillons de jeter la première tasse de café préparée.

## 14 Commande d'accessoires

Pour profiter le plus longtemps possible de votre appareil et éviter des pannes prématurées, il est très important de nettoyer et de détartrer régulièrement l'appareil. Vous pourrez également vous procurer le détartrant original directement auprès de nos services.

Veillez-vous adresser à notre hot-line de commande en Allemagne

1801 - 20 30 60\*

(\*communication locale, à partir du réseau fixe de la Deutsche Telekom)

du lundi au vendredi de 8h00 à 18h00

## 15 Que faire lorsque le message suivant apparaît à l'écran ...

**Le symbole ☰ reste allumé en permanence**

- Le réservoir d'eau est vide ou n'est pas mis bien en place.
- ☞ Remplir le réservoir d'eau et le mettre en place correctement, voir „Remplir d'eau" page 57.
- Le réservoir d'eau est sale ou il est entartré.

- ☞ Rincer le réservoir d'eau et le détartrer.

**Les symboles ☰ et △ clignotent**



- La machine à café ne peut pas préparer de café.
- ☞ Placer un récipient sous la buse à vapeur et tourner le sélecteur de vapeur et eau chaude dans les sens inverse des aiguilles d'une montre pour l'amener dans la position ☰ (Figure 9).
- Le café passe trop lentement.
- ☞ Tourner le bouton de réglage du degré de mouture (Figure 12) d'un cran dans le sens des aiguilles d'une montre, tant que le broyeur mout du café en grains pendant une préparation de café (voir „Régler le degré de mouture" page 65).

**Le symbole  reste allumé en permanence**

- Le bac à résidus est plein.
-  Vider, nettoyer le bac à résidus comme indiqué „Vider le bac à résidus" page 67 et le remettre en place correctement.



**Le symbole  clignote**

- Le bac à résidus n'a pas été remis en place après le nettoyage.
-  Ouvrir le panneau de service et mettre le bac à résidus en place.

**Les symboles  ou  et  clignotent**

- Après avoir sélectionné la fonction Café prémoulu, il n'y a pas eu de café moulu de versé dans l'entonnoir de remplissage.
-  Verser le café moulu comme indiqué sous „Préparer le café avec du café moulu" page 63.

**Tous les symboles pour l'intensité d'arôme      et  clignotent**

- Il n'y a plus de grains de café dans le conteneur de grains.
-  Remplir le conteneur de grains de café, voir „Remplir le conteneur de grains de café" page 57.
- Si le broyeur est très bruyant, cela signifie qu'un petit caillou se trouvant parmi les grains de café a bloqué le broyeur.
-  Adressez-vous au Service Après-Vente. **Si le broyeur est bloqué ou endommagé à cause d'un corps étranger, ceci ne sera, éventuellement, pas couvert par la garantie.**



**Le symbole  reste allumé en permanence**

- Indique que la machine à café est entartrée.
-  Le programme de détartrage décrit au chapitre „Lancer le programme de détartrage" page 69 doit être lancé le plus rapidement possible.

**Le symbole  reste allumé en permanence**

- Le panneau de service est ouvert.
-  Fermer le panneau de service. S'il n'est pas possible de fermer le panneau de service, assurez-vous que l'unité d'infusion est bien mise en place correctement (voir „Nettoyer l'unité d'infusion" page 68)





**Le symbole  clignote**

- Sans doute a-t-on oublié de replacer l'unité d'infusion dans la machine à café après son nettoyage.
-  Pour insérer l'unité d'infusion, voir „Nettoyer l'unité d'infusion" page 68
- L'intérieur de la machine est très encrassé.
-  Nettoyer soigneusement l'intérieur de la machine, voir „Nettoyer l'unité d'infusion" page 68. Si une fois le nettoyage effectué, la machine à café affiche encore ce message, veuillez vous adresser au Service Après Vente.

**Le symbole  reste allumé en permanence**

- C'est le signe d'une alarme générale.
-  Prière de s'adresser au service après-vente.

**Les symboles  et  clignotent**

- L'appareil a été mis en marche avec le bouton tournant pour la vapeur et l'eau chaude en position "Ouvert"  .
-  Tourner le bouton tournant pour la vapeur et l'eau chaude dans le sens des aiguilles d'une montre (Figure 10) jusqu'à la butée sur la position .

**Les symboles  et  clignotent**

- La température ambiante est trop basse pour que l'on puisse faire fonctionner l'appareil.
-  Faire fonctionner l'appareil dans une pièce plus chaude.

F

## 16 Problèmes auxquels vous pouvez remédier avant d'appeler le Service Après-Vente

Si la machine à café ne fonctionne pas, vous pouvez facilement trouver la cause de ce dysfonctionnement et y remédier en consultant le chapitre „Que faire lorsque le message suivant apparaît à l'écran ..." page 70. Si la machine à café ne devait, par contre, pas afficher de symbole, prière de procéder aux contrôles suivants avant de s'adresser au Service Après-Vente.

### Le café n'est pas chaud

- Les tasses n'ont pas été réchauffées auparavant.
- ☞ Réchauffez les tasses en les rinçant à l'eau chaude ou en les laissant au moins 20 minutes sur le repose-tasse chauffé (H) (voir „Conseils pour obtenir un café plus chaud" page 61).

### Le café n'a pas assez de crème

- Le café est moulu trop grossièrement.
- ☞ Tourner le bouton de réglage du degré de mouture d'un cran dans le sens inverse des aiguilles d'une montre, tant que le broyeur mout du café en grains pendant une préparation de café (voir „Régler le degré de mouture" page 65).
- Le mélange de café ne convient pas.
- ☞ Utiliser un mélange de café convenant aux machines à café entièrement automatiques.

### Le café passe trop lentement

- Le café est moulu trop finement:
- ☞ Tourner le bouton de réglage du degré de mouture d'un cran dans le sens des aiguilles d'une montre, tant que le broyeur mout du café en grains pendant une préparation de café (voir „Régler le degré de mouture" page 65).

### Le café passe trop rapidement

- Le café est moulu trop grossièrement.
- ☞ Tourner le bouton de réglage du degré de mouture d'un cran dans le sens inverse des aiguilles d'une montre, tant que le broyeur mout du café en grains pendant une préparation de café (voir „Régler le degré de mouture" page 65).

### Le café ne sort que de l'un des becs verseurs du bloc distributeur de café

- Les trous des becs verseurs sont colmatés.
- ☞ Retirer le café séché à l'aide d'une aiguille (Figure 29).

### Malgré que vous ayez tourné le sélecteur rotatif de vapeur et d'eau chaude, il ne sort pas de vapeur de la buse à vapeur

- Les petits trous de la buse à vapeur et l'élément intérieur de la buse à vapeur sont colmatés.
- ☞ Déboucher les trous de la buse à vapeur et de l'élément intérieur (voir „Nettoyer la buse à vapeur" page 65).

### Lorsque la fonction ☞ ou ☞☞ est activée, il ne sort pas de café mais de l'eau de la machine.

- Il se peut que du café moulu soit resté coincé dans l'entonnoir de remplissage.
- ☞ Retirer le café moulu resté coincé dans l'entonnoir de remplissage à l'aide d'un couteau (voir „Préparer le café avec du café moulu" page 63) (Figure 22). Ensuite, nettoyer l'unité d'infusion et l'intérieur de la machine (voir „Nettoyer l'unité d'infusion" page 68)

### Lorsqu'on appuie sur la touche ①, la machine ne se met pas en marche.

- L'interrupteur principal se trouvant au dos de la machine n'est pas enclenché (Figure 8) ou la fiche n'est pas branchée sur la prise secteur.
- ☞ Vérifiez si l'interrupteur principal est en position „I" et si la fiche est bien branchée dans la prise.



### Il n'est pas possible de retirer l'unité d'infusion pour la nettoyer

- La machine est en marche. L'unité d'infusion ne peut être retirée que lorsque la machine est éteinte.
- ☞ Éteindre l'appareil et enlever l'unité d'infusion, voir „Nettoyer l'unité d'infusion" page 68.

**i** Attention: L'unité d'infusion ne peut être retirée que lorsque l'appareil a été éteint au moyen de la touche marche/arrêt ① se trouvant sur la face avant de la machine. L'appareil ne doit pas être débranché du secteur. Si vous essayez de retirer l'unité d'infusion alors que la machine à café est en marche, celle-ci pourrait être sérieusement endommagée.

### Le café ne sort pas des becs verseurs du bloc distributeur de café mais sur le côté par le panneau de service.

- Les orifices du bloc distributeur de café sont colmatés par du café séché.
- ☞ Retirer le café séché à l'aide d'une aiguille (Figure 29).
- Le compartiment pivotant se trouvant à l'intérieur du panneau de service (R) est bloqué et n'oscille pas.
- ☞ Nettoyer soigneusement le compartiment pivotant, en particulier du côté des charnières afin que celles-ci puissent s'ouvrir et se fermer.

### On a utilisé du café moulu (au lieu de grains de café), et la machine ne délivre pas de café.

- On a versé trop de café prémoulu.
- ☞ Retirer l'unité d'infusion et nettoyer soigneusement l'intérieur de la machine comme indiqué sous „Nettoyer l'unité d'infusion" page 68. Renouveler l'opération en utilisant au maximum 2 cuillères de dosage rases.
- Le sélecteur rotatif "Intensité d'arôme / café prémoulu" n'a pas été placé sur la position ☞ ou ☞☞ et l'appareil a utilisé à la fois le café prémoulu et la poudre provenant du broyeur.

☞ Nettoyer soigneusement l'intérieur de la machine comme indiqué sous „Nettoyer l'unité d'infusion" page 68. Renouveler l'opération après avoir d'abord placé le bouton rotatif "Intensité d'arôme / café prémoulu" sur la position convenable comme décrit sous „Préparer le café avec du café moulu" page 63.

- Le café prémoulu a été versé dans la machine alors qu'elle était éteinte.

☞ Retirer l'unité d'infusion et nettoyer soigneusement l'intérieur de la machine comme décrit sous „Nettoyer l'unité d'infusion" page 68. Renouveler l'opération la machine étant en marche.

### Que faire si l'on doit transporter l'appareil ?

- Conserver l'emballage d'origine pour le protéger pendant le transport. Pour protéger l'appareil contre les éraflures, utiliser impérativement le sachet en plastique d'origine.
- Maintenir la machine à café et la verseuse isotherme à l'abri des chocs. Nous déclinons toute responsabilité en cas de détériorations pendant le transport.
- Vider le réservoir d'eau et le bac à résidus.
- Veuillez également faire attention à l'endroit où vous entreposez votre appareil, surtout pendant la saison froide. Il peut être endommagé par le gel.

## 17 Mode Statistique

L'appareil offre la possibilité de demander les valeurs suivantes : - le nombre de tous les cafés jusqu'ici préparés avec l'appareil:



- le nombre de tous les cafés jusqu'ici préparés avec l'appareil,
- le nombre des carafes préparées avec 4 tasses, avec 6 tasses, 8 tasses et 10 tasses,

F





- le nombre des détartrages réalisés et, en outre
- nombre de litres d'eau qui ont été versés avec la machine.

 Si deux tasses de café sont préparées en même temps, elles seront également comptées comme deux tasses.







Pour mettre en marche le mode Statistique, il faut arrêter l'appareil.

 Si nécessaire, arrêter l'appareil avec la touche "Marche/Arrêt"  (Figure 11).

 Appuyer pendant au minimum sur la touche "P" (Figure 4).

Les symboles "P" et  restent allumés. En outre, les trois petits symboles au-dessus des touches ,  et , s'allument afin d'indiquer la fonction momentanée de ces touches, voir „Mode Spécial" page 57.





 Appuyer autant de fois que nécessaire sur les touches Feuilletter "<" ou ">" (Figure 5) jusqu'à ce que s'allume le symbole pour lequel la statistique respective doit être affichée:

-  Nombre de cafés préparés
-  Nombre des détartrages effectués
-  Nombre de carafes préparées avec 4 tasses
-  Nombre de carafes préparées avec 6 tasses
-  Nombre de carafes préparées avec 8 tasses
-  Nombre de carafes préparées avec 10 tasses
-  Nombre de litres d'eau versés

Quand un symbole s'allume, il est possible d'afficher le nombre correspondant ci-après:

 Appuyer sur la touche "OK" et la maintenir enfoncée (Figure 5).





Maintenant, quelques affichages commencent à clignoter les uns après les autres, ce qui indique le nombre demandé:

-  1 clignotement correspond à 1
-  1 clignotement correspond à 10
-  1 x clignotement correspond à 100
-  1 clignotement correspond à 1,000
-  1 clignotement correspond à 10,000

Les signes de clignotement se répètent en permanence aussi longtemps que l'on appuie sur la touche "OK". Avant chaque répétition, respecter une pause de 3 secondes.

 Compter le nombre de clignotements successifs.

Exemple : les séries de clignotements suivants correspondent au nombre 1.529.

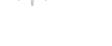
-  9 clignotements
-  2 clignotements
-  5 clignotements
-  1 clignotement
-  0 clignotement

 Pour quitter le mode Statistique, maintenir enfoncée la touche "P" (Figure 4) pendant au minimum 6 secondes.

## 18 Caractéristiques techniques 20 S'il vous faut faire appel au Service Après-Vente

Tension du réseau: 220-240 V

Puissance absorbée: 1350 W

**CE** Cet appareil est conforme aux directives UE suivantes:

- 73/23/CEE du 19.2.1973 "Directive basse tension", y compris la directive modificatrice 93/68/CEE.
- 89/336/CEE du 03.05.89 "Directive relative à la compatibilité électromagnétique", y compris la directive modificatrice 92/31/CEE.

Conserver impérativement l'emballage d'origine, y compris les inserts en mousse. Pour éviter tout dommage lors du transport, l'appareil doit être emballé méticuleusement.

En cas d'envoi de l'appareil, toujours joindre la carafe isotherme. Celle-ci est nécessaire pour le test de l'appareil.

## 19 Mise au rebut



### Matériel d'emballage

Les matériaux d'emballage sont écologiques et recyclables. Les pièces en matière plastique portent un signe distinctif, par ex. >PE<, >PS< etc. Éliminez les matériaux d'emballage en fonction de leur signe distinctif dans les centres de traitement des déchets de la commune, dans les conteneurs prévus à cet effet.



### Appareil usagé

Le symbole  sur le produit ou son emballage indique que ce produit ne doit pas être considéré comme un déchet ménager ordinaire mais qu'il doit être remis à un centre de collecte pour le recyclage d'appareils électriques et électroniques. En veillant à l'élimination correcte de ce produit, vous contribuez à préserver l'environnement et la santé. L'élimination incorrecte des déchets constitue une menace pour l'environnement et la santé. Pour obtenir plus de détails sur le recyclage de ce produit, veuillez prendre contact avec votre mairie, votre service d'enlèvement des déchets ménagers ou le magasin où vous avez acheté le produit.

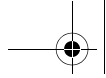

F

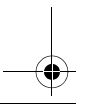
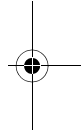
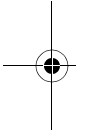

76

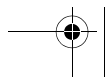
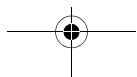
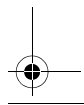

**(NL) Geachte klant,**

wij verzoeken u deze gebruiksaanwijzing zorgvuldig door te lezen. Let vooral op de veiligheidsaanwijzingen! Bewaar de gebruiksaanwijzing om deze later te raadplegen en geef hem aan eventuele latere eigenaars van het apparaat door.

**Inhoud**

<b>1</b>	<b>Legenda</b>	<b>78</b>	<b>10</b>	<b>Heet water maken</b>	<b>88</b>
1.1	Voorraanzicht (afbeelding 1)	78	<b>11</b>	<b>Maalgraad instellen</b>	<b>89</b>
1.2	Voorraanzicht met open servicedeur (afbeelding 2)	78	<b>12</b>	<b>Koffietemperatuur instellen</b>	<b>89</b>
1.3	Bedieningspaneel (afbeelding 3)	78	<b>13</b>	<b>Reiniging en verzorging</b>	<b>90</b>
<b>2</b>	<b>Koffie en espresso</b>	<b>79</b>	13.1	Regelmatige reiniging	90
<b>3</b>	<b>Veiligheidsvoorschriften</b>	<b>79</b>	13.2	Koffiedikreservoir legen	90
<b>4</b>	<b>Speciale modus</b>	<b>81</b>	13.3	Maalmechanisme reinigen	91
<b>5</b>	<b>Eerste ingebruikneming</b>	<b>81</b>	13.4	Koffiezeteenheid reinigen	91
5.1	Apparaat opstellen en aansluiten	81	13.5	Ontkalkingsprogramma uitvoeren	92
5.2	Met water vullen	81	<b>14</b>	<b>Bestellen van accessoires</b>	<b>93</b>
5.3	Koffiebonenreservoir vullen	81	<b>15</b>	<b>Wat moet u doen als op de display de volgende melding verschijnt...</b>	<b>93</b>
5.4	Eerste keer inschakelen	82	<b>16</b>	<b>Problemen die opgelost kunnen worden voordat u de klantendienst belt</b>	<b>94</b>
5.5	Apparaat inschakelen	82	<b>17</b>	<b>Statistiek-modus</b>	<b>96</b>
5.6	Apparaat uitschakelen	82	<b>18</b>	<b>Technische gegevens</b>	<b>97</b>
5.7	Waterhardheid instellen	83	<b>19</b>	<b>Afvalverwerking</b>	<b>98</b>
<b>6</b>	<b>Koffie zetten met bonen</b>	<b>83</b>	<b>20</b>	<b>Service</b>	<b>98</b>
6.1	Tips voor afgifte van hetere koffie	85			
<b>7</b>	<b>Meerdere koppen koffie zetten met de kanfunctie</b>	<b>85</b>			
<b>8</b>	<b>Koffie zetten met poeder</b>	<b>86</b>			
<b>9</b>	<b>Melk opschuimen</b>	<b>87</b>			
9.1	Stoompijpje reinigen	88			

(NL)

## 1 Legenda















### 1.1 Vooraanzicht (afbeelding 1)

- A Afdruiprooster
- B Warmhoudkan
- C Hoofdschakelaar (achterkant van apparaat)
- D In de hoogte verstelbare koffieuitloop
- E Bedieningspaneel (zie afbeelding 3)
- F Deksel voor koffiebonenreservoir
- G Deksel voor koffiepoederschacht
- H Verwarmd afzetvlak voor kopjes
- J Zwenkbaar pijpje voor stoom en heet water
- K Stoompijpje (afneembaar)
- L Binnendeel van stoompijpje (afneembaar)
- M Knop om servicedeur te openen
- N Watertank met max-markering (uitneembaar)
- O Afdruipbakje met vlotter (uitneembaar)

### 1.2 Vooraanzicht met open servicedeur (afbeelding 2)

- P Servicedeur (open)
- Q Koffiedikreservoir (uitneembaar)
- R Zwenkvak
- S Koffiezeteenheid
- T Knop voor instelling van maalgraad
- U Koffiebonenreservoir
- V Maatlepel
- W Vulschacht voor voorgemalen koffie
- X Typeplaatje (onderkant van het apparaat)
- Y Vloeibaar ontkalkingsmiddel
- Z Teststrook

### 1.3 Bedieningspaneel (afbeelding 3)

- a Draaiknop "Koffiesterkte / voorgemalen koffie"
- b Draaiknop "Kopgrootte"
- c Display
- d Toets "1 kop koffie"   
Modus dient diese Taste für das "Blättern" (" $<$ ")
- e Toets "2 koppen koffie"   
Modus dient diese Taste für das "Blättern" (" $>$ ")
- f Toets "Stoom"   
In de speciale modus bevestigt deze toets het menupunt ("OK")
- g Toets "P"  
In de speciale modus gaat deze toets terug naar het vorige niveau zonder veranderingen uit te voeren ("P")
- h Toets "Aan/uit" 
- j Draaiknop voor stoom en heet water
- k Toets "Kan" 
- l Symbolen "Voorgemalen koffie"
- m Symbolen "Kan"
- n Symbolen "Koffiesterkte"
- o Symbolen "Kopgrootte"
- p Symbool "Watertank leeg" 
- q Symbool "Ontkalken" 
- r Symbool "Temperatuur apparaat" 
- s Symbool "Servicedeur open" 
- t Symbool "Koffiedikreservoir" 
- u Symbool "Attentie" 
- v Symbool "Heet water" 
- w Symbool "Stoom" 
- x Symbool "2 koppen zetten" 
- y Symbool "1 kop zetten" 
- z Symbolen voor de speciale modus

## 2 Koffie en espresso

De werking van uw volautomatische machine garandeert u zeer gemakkelijke **bediening**, zowel bij het koffie zetten als bij onderhoud en verzorging. De voortreffelijke, individuele **smaak** wordt bereikt door

- het voorkookstelsel: voor het eigenlijke zetten wordt de gemalen koffie vochtig gemaakt om het volledige aroma vrij te maken,
- de individueel instelbare hoeveelheid water per kop tussen een kleine espresso en een grote koffie met crema,
- de individueel instelbare koffietemperatuur waarmee de koffie wordt gezet,
- de keuzemogelijkheid tussen een normaal en een sterk kopje koffie,
- de op de branding van de bonen instelbare maalgraad,
- en niet op de laatste plaats door de gegarandeerde crema, het schuimlaagje dat espressokoffie voor kenners zo uniek maakt.

**Overigens:** de contacttijd van het water met de gemalen koffie is bij espressokoffie veel korter dan bij traditionele filterkoffie. Hierdoor komen er minder bitterstoffen uit de koffie vrij, wat de espressokoffie veel lichter verteerbaar maakt!

## 3 Veiligheidsvoorschriften



De veiligheid van dit apparaat voldoet aan de officiële regels der techniek en de wet in het kader van veilige apparaten. Toch voelen wij ons als verplicht u op de volgende veiligheidsvoorschriften te wijzen.

### Algemene veiligheid

- Het apparaat mag alleen worden aangesloten aan een stroomnet waarvan spanning, stroomtype en frequentie overeenkomen met de specificaties op het typeplaatje (zie onderkant van het apparaat)!
- Het snoer nooit met hete onderdelen van het apparaat in contact laten komen.
- De stekker nooit aan het snoer uit het stopcontact trekken!
- Het apparaat niet in gebruik nemen als:
  - het snoer beschadigd is
  - de ommanteling zichtbare schade vertoont.
- Snoer alleen in het stopcontact steken wanneer het apparaat uitgeschakeld is.
- Dit apparaat is niet geschikt voor personen (ook kinderen) met een lichamelijke, sensorische of geestelijke handicap of met gebrek aan ervaring en kennis, tenzij zij het gebruik van het apparaat eerst hebben geleerd onder toezicht of met instructie van een persoon die voor hun veiligheid verantwoordelijk is.

### Veiligheid van kinderen

- Laat het apparaat niet zonder toezicht lopen en voorkom vooral dat kinderen letsel oplopen!
- Verpakkingsmateriaal, zoals plastic zakken, horen niet in de handen van kinderen.

### Veiligheid tijdens het gebruik

- **Attentie! Koffieuitloop, stoompijpe en afzetvlak voor kopjes worden tijdens het gebruik heet. Houd kinderen uit de buurt!**

(NL)

- **Attentie! Verbrandingsgevaar als het stoompijpje actief is!** Uitstromend heet water of hete stoom kan tot brandwonden leiden. Activeer het stoompijpje alleen als u een kopje of bakje onder het stoompijpje houdt.
- Geen ontvlambare vloeistoffen met stoom verhitten!
- Het apparaat alleen gebruiken als er zich water in het systeem bevindt! Alleen koud water in de watertank doen, geen heet water, melk of andere vloeistoffen. Neem de max. vulhoeveelheid van ca. 1,8 liter in acht.
- Geen bevroren of gekarameliseerde koffiebonen in het bonenreservoir doen, alleen gebrande koffiebonen! Verwijder vreemde elementen, zoals steentjes, uit de koffiebonen. Als het maalwerk door een vreemd element geblokkeerd of beschadigd wordt, wordt dit eventueel niet door de garantie gedekt.
- Alleen gemalen koffie in de vulopening voor gemalen koffie doen.
- Apparaat niet onnodig ingeschakeld laten.
- Apparaat niet blootstellen aan weersinvloeden.
- Bij gebruik van een verlengsnoer alleen een normaal snoer met een geleiderdoorsnede van minstens 1,5 mm<sup>2</sup> gebruiken.
- Personen met motorische storingen mogen het apparaat nooit zonder begeleidende persoon gebruiken, om risico's te voorkomen.
- Het apparaat alleen gebruiken als het afdruiptbakje, het koffiedikreservoir en het afdruiiprooster ingezet zijn!

### Veiligheid bij reiniging en verzorging

- Reinigings- en ontkalkingsinstructies in acht nemen.
- Voor onderhoud of reiniging apparaat uitschakelen en stekker uit het stopcontact trekken!
- Apparaat niet in water onderdompelen.
- Het stoompijpje alleen schoonmaken als er geen druk is en het apparaat koud en uitgeschakeld is!
- Onderdelen van het apparaat niet in de vaatwasmachine wassen.
- **Nooit water in het maalmechanisme doen;** daardoor wordt het maalmechanisme beschadigd.

Het apparaat niet open maken en niet repareren. Ondeskundig uitgevoerde reparaties kunnen gevaarlijk zijn voor de gebruiker.

Reparaties aan elektrische apparaten mogen alleen door vakmensen worden uitgevoerd.

Bij een evt. noodzakelijke reparatie of vervanging van het snoer dient contact te worden opgenomen met



- de winkel waar u het apparaat hebt gekocht of
- de servicelijn van AEG/Electrolux.

Als het toestel verkeerd wordt gebruikt of bediend, kunnen wij niet aansprakelijk gesteld worden voor eventuele schade die hieruit voortvloeit; dit geldt ook voor schade die ontstaat doordat het ontkalkingsprogramma niet onmiddellijk na het verschijnen van het symbool  volgens de instructies in deze gebruiksaanwijzing wordt uitgevoerd. Als het maalwerk door een vreemd element geblokkeerd of beschadigd wordt, wordt dit eventueel niet door de garantie gedekt.



## 4 Speciale modus

Voor het instellen van de waterhardheid („Waterhardheid instellen” pagina 83) en de koffietemperatuur („Koffietemperatuur instellen” pagina 89), voor het starten van het ontkalkingsprogramma („Ontkalkingsprogramma uitvoeren” pagina 92) en om de statistiek te bekijken („Statistiek-modus” pagina 96) schakelt u met de toets "P" (afbeelding 4) over naar de speciale modus. In de speciale modus dienen de toetsen "1 kop koffie" , "2 koppen koffie" , "Stoom"  en "P" voor het navigeren. De betreffende functie wordt op de display boven de toets aangegeven (afbeelding 5):

- "<" ("1 kop koffie" ) en ">" ("2 koppen koffie" ) dienen voor het bladeren in het menu
- "OK" ("Stoom" ) bevestigt een menupunt
- "P" ("P") gaat terug naar het vorige niveau, zonder een verandering uit te voeren

## 5 Eerste ingebruikneming

### 5.1 Apparaat opstellen en aansluiten

Kies een passende, horizontale, stabiele, onverwarmde, droge en waterbestendige ondergrond.

-  Zorg voor een goede luchtcirculatie. Aan de zijkanten en aan de achterkant van het apparaat moet een vrije ruimte van minstens 5 cm zijn, en boven het apparaat een vrije ruimte van minstens 20 cm.

Het apparaat mag niet worden opgesteld in een vertrek waarin temperaturen van 0°C of lager kunnen voorkomen (apparaat wordt beschadigd door bevroren water).



-  **Attentie!** Als het apparaat vanuit de kou in een warm vertrek wordt opgesteld, ca. 2 uur wachten alvorens het in te schakelen!

Wij raden u aan een geschikte onderlaag onder het apparaat te plaatsen om beschadiging door spatten te voorkomen.

-  Sluit het apparaat uitsluitend aan een geaard stopcontact aan. Gebruik geen niet-geaard stopcontact.

### 5.2 Met water vullen

Controleer elke keer voor het inschakelen of de watertank water bevat en vul hem indien nodig. Het apparaat heeft bij elk inschakel- en uitschakelproces water nodig voor het automatische spoelen.

-  Haal de watertank uit het apparaat (afbeelding 6). Draai het stoompijpe altijd naar het midden van het apparaat voordat u de watertank weghaalt, anders kan de tank niet weggehaald worden.
-  Vul de watertank met vers koud water. Vul de tank nooit tot boven de MAX-markering.

-  Doe alleen koud water in de watertank. Nooit andere vloeistoffen, zoals mineraalwater of melk, erin doen.

-  Breng de watertank weer aan (afbeelding 6). Druk de tank daarbij vast aan, zodat het ventiel van de watertank open gaat.

-  Om altijd een aromatische koffie te krijgen moet u:

- het water in de watertank dagelijks verversen,
- de watertank minstens eens per week in normaal afwaswater (niet in de vaatwasmachine) schoonmaken. Vervolgens met schoon water afspoelen.

### 5.3 Koffiebonenreservoir vullen

-  Klap de deksel van het koffiebonenreservoir open en vul het met verse koffiebonen (afbeelding 7). Doe de deksel dan weer dicht.

-  **Attentie!** Geen bevroren of gekarameliseerde koffiebonen in het bonenreservoir doen, alleen gebrande koffiebonen! Vergewis u ervan dat er

NL

geen vreemde elementen, zoals steentjes, in het bonenreservoir komen. **Als het maalwerk door een vreemd element geblokkeerd of beschadigd wordt, wordt dit eventueel niet door de garantie gedekt.**

 Het maalmechanisme is in de fabriek op een middelfijne maalgraad ingesteld. Als het nodig is, kunt u deze instelling veranderen. Instructies voor het instellen van het maalmechanisme vindt u bij „Maalgraad instellen“ pagina 89.

 **De maalgraad mag alleen tijdens het malen veranderd worden. Instellen terwijl het maalmechanisme stilstaat, kan de koffiemachine beschadigen.**

 De koffiemachine is in de fabriek getest. Hiervoor is koffie gebruikt, dus het is volkomen normaal als u een beetje koffie in het maalmechanisme aantreft. Deze koffiemachine is in ieder geval gegarandeerd nieuw.

#### 5.4 Eerste keer inschakelen

Als u het apparaat de eerste keer gebruikt, moet de koffiemachine ontvlucht worden.



 Schakel het apparaat in met de hoofdschakelaar aan de achterkant van het apparaat (afbeelding 8).



Als de hoofdschakelaar de allereerste keer wordt ingeschakeld, gaan alle symbolen op de display een paar seconden aan voor een zelftest, daarna knipperen de symbolen  en .



 Watertank vullen: zie „Met water vullen“ pagina 81.

 Breng de watertank weer aan (afbeelding 6). Druk de tank daarbij vast aan, zodat het ventiel van de watertank open gaat.

 Draai het stoompijpje naar buiten en zet er een kopje onder (afbeelding 9).

 Draaiknop voor stoom en heet water zo ver mogelijk tegen de klok in naar de stand  draaien (afbeelding 10).

Er loopt wat water uit het stoompijpje. De symbolen  en  branden continu.

Als het kopje met circa 30 ml water gevuld is, beginnen de symbolen  en  te knipperen.



 Draaiknop voor stoom en heet water zo ver mogelijk met de klok mee naar de stand  draaien (afbeelding 10) om het stromen van het water uit te zetten.

Het symbool  knippert enkele seconden en het apparaat schakelt uit.



 Het koffiebonenreservoir met koffiebonen vullen, zie „Koffiebonenreservoir vullen“ pagina 81.

#### 5.5 Apparaat inschakelen

Controleer elke keer voor het inschakelen of de watertank water bevat en vul hem indien nodig. Het apparaat heeft bij elk inschakel- en uitschakelproces water nodig voor het automatische spoelen.

 Schakel het apparaat met de toets „Aan/uit“  in (afbeelding 11).



 Direct na het inschakelen gaat het apparaat aan. De daardoor veroorzaakte geluiden zijn volkomen normaal.

 Tijdens het opwarmproces (ca. 120 seconden) knippert het symbool . Tijdens het opwarmen wordt er automatisch gespoeld (er stroomt een beetje heet water uit de koffieuitloop, dat in het afdruiptakje wordt opgevangen).



Na afloop van het opwarmen brandt het symbool  continu.

Het apparaat is nu bedrijfsklaar. De symbolen branden in overeenstemming met de laatst gekozen koffiemodus.

#### 5.6 Apparaat uitschakelen

 Schakel het apparaat met de toets „Aan/uit“  uit (afbeelding 11).

Het symbool  knippert. Het apparaat voert een spoelproces uit en schakelt uit.

-  Als het apparaat lang niet wordt gebruikt, wordt het ter wille van de energiebesparing automatisch na 3 uur uitgeschakeld.
-  Als u het apparaat lang niet gebruikt, moet u na het uitschakelen met de toets "Aan/uit" ook nog de hoofdschakelaar aan de achterkant van het apparaat uitschakelen (fig. 8).

### 5.7 Waterhardheid instellen

Na de eerste ingebruikneming of bij gebruik van een andere waterkwaliteit moet u het apparaat instellen op de waterhardheidsstand die overeenkomt met de plaatselijke waterhardheid. Gebruik het bijgeleverde teststaafje om de hardheidsstand te bepalen of vraag bij uw watermaatschappij naar de hardheid.

#### Bepalen van het waterhardheidsniveau

-  Doop hiervoor het teststrookje ca. 1 seconde in koud water. Schud het overtollige water eraf en bepaal het hardheidsniveau aan de hand van de roze vakjes.

 **Geen of één vakje roze: hardheidsniveau 1, zacht**  
tot 1,24 mmol/l of  
tot 7° Duitse hardheid of  
tot 12,6° Franse hardheid

 **Twee vakjes roze: hardheidsniveau 2, middelhard**  
tot 2,5 mmol/l of  
tot 14° Duitse hardheid of  
tot 25,2° Franse hardheid





 **Drie vakjes roze: hardheidsniveau 3, hard**  
tot 3,7 mmol/l of  
tot 21° Duitse hardheid of  
tot 37,8° Franse hardheid

 **Vier vakjes roze: hardheidsniveau 4, zeer hard**  
meer dan 3,7 mmol/l of  
meer dan 21° Duitse hardheid of  
meer dan 37,8° Franse hardheid

#### Instellen en opslaan van het bepaalde waterhardheidsniveau

U kunt 4 hardheidsniveaus instellen. Het apparaat is in de fabriek op hardheidsniveau 4 ingesteld.

-  Druk, terwijl het apparaat ingeschakeld is, op de toets "P" (afbeelding 4).

De symbolen "P" en  branden. Bovendien branden de 3 kleine symbolen boven de toetsen ,  en  om de momentele functie van de toetsen aan te geven; zie „Speciale modus" pagina 81.

-  Bevestig de keus met de toets "OK" (afbeelding 5).

De display geeft de momentele instelling aan. De hardheidsniveaus worden als volgt aangegeven:

 Hardheidsniveau 1  
 Hardheidsniveau 2  
 Hardheidsniveau 3  
 Hardheidsniveau 4

-  Druk vervolgens op de bladertoetsen "<" of ">" (afbeelding 5) tot het vastgestelde hardheidsniveau wordt weer gegeven.

-  Bevestig de keus met de toets "OK" (afbeelding 5). Dit hardheidsniveau is nu opgeslagen.

-  Om af te breken zonder opslaan drukt u op "P" in plaats van "OK".

Als er niet op "OK" wordt gedrukt, gaat het apparaat na ca. 120 seconden automatisch terug naar de koffiemo-  
dus, zonder de invoer op te slaan.

-  Om terug te gaan naar de koffiemo-  
dus drukt u vervolgens op de toets "P" (figuur 4) of wacht u ca. 120 sec. tot het apparaat automatisch terugspringt naar de koffiemo-  
dus.

## 6 Koffie zetten met bonen

Het volgende proces vindt **volautomatisch** plaats als u koffie zet met bonen: malen, portioneren, persen, voorkoken, zetten en uitwerpen van de verbruikte gemalen koffie.

(NL)

Door middel van de maalgraad en de maalhoeveelheid kunt u het apparaat individueel op uw persoonlijke smaak instellen.



Geen bevroren of gekarameliseerde koffiebonen in het bonenreservoir doen, alleen gebrande koffiebonen! Vergewis u ervan dat er geen vreemde elementen, zoals steentjes, in het bonenreservoir komen. **Als het maalwerk door een vreemd element geblokkeerd of beschadigd wordt, wordt dit eventueel niet door de garantie gedekt.**

Kies afhankelijk van uw smaak een kleine espresso of een grote koffie met crema.



Kies de gewenste kopgrootte met de draaiknop "Kopgrootte" (afbeelding 12). De gekozen kopgrootte wordt aangegeven.



De kopgrootten worden als volgt aangegeven:

	Espressokopje
	Klein kopje
	Kopje medium
	Grote kop
	Beker

U kunt uw koffie met extra zachte, zachte, normale, sterke of extra sterke smaak kiezen.



Kies de gewenste koffiesterkte met de draaiknop "Koffiesterkte" (afbeelding 13). De gekozen koffiesterkte wordt aangegeven.



De koffiesterkte wordt als volgt aangegeven:

	Extra zacht
	Zacht
	Normaal
	Sterk
	Extra sterk



Zet een of twee kopjes onder de koffiefuitleop (afbeelding 14). Door de uitloop omhoog of omlaag te schuiven kunt u de uitloophoogte optimaal aan

de hoogte van uw kopjes aanpassen om warmteverlies en koffiespatten te verminderen (afbeelding 15).



Druk op de toets "1 kopje" om één kopje te zetten of op de toets "2 koppen koffie" voor 2 kopjes.

Het symbool "1 kopje" of "2 kopjes" brandt. Het apparaat maalt nu de bonen. Bij het zetten van de koffie wordt de gemalen koffie bij het voor-koken eerst met een kleine hoeveelheid water vochtig gemaakt. Na een korte pauze volgt dan het eigenlijke zetten van de koffie. De koffie wordt in de kop geschonken.

Als de gewenste hoeveelheid koffie afgegeven is, beëindigt het apparaat het schenken automatisch en werpt de verbruikte koffie in het koffiedikreservoir uit. Gedurende deze tijd knippert het symbool "1 kopje" of "2 kopjes" .



U kunt de afgifte van de koffie op elk gewenst moment voortijdig afbreken door nog eens kort op de toets "1 kop" of "2 koppen" te drukken of door de draaiknop "Kopgrootte" (afbeelding 12) tegen de klok in de richting van "Espressokopje" te draaien.



Zodra de afgifte van koffie beëindigd is, kunt u de hoeveelheid koffie vergroten door op de toets "1 kopje" of "2 kopjes" te drukken en deze ingedrukt te houden tot de gewenste hoeveelheid koffie bereikt is of door de draaiknop "Kopgrootte" (afbeelding 12) met de klok mee in de richting van "Beker" te draaien (dit moet gebeuren onmiddellijk nadat de koffie is afgegeven en voordat de verbruikte koffie in het koffiedikreservoir wordt uitgeworpen).

Na een paar seconden, als het symbool "1 kopje" of "2 kopjes" uit is, is het apparaat weer bedrijfsklaar en kunt u de volgende kop koffie zetten.



Als de koffie druppelsgewijs of helemaal niet uit het apparaat komt of de koffie te snel wordt afgegeven en de crema u niet bevalt, kunt u de maal-

graadinstelling veranderen: zie „Maalgraad instellen“ pagina 89.

- i** Als de symbolen  en  knipperen, is de koffie te fijn gemalen. U moet de maalgraadinstelling veranderen; zie „Maalgraad instellen“ pagina 89.
- i** Als het symbool  brandt, moet u de watertank vullen, anders kan het apparaat geen koffie zetten. (Het is normaal dat de watertank nog een beetje water bevat als het symbool verschijnt.)
- i** Als het symbool  brandt, is het koffiedikreservoir vol en moet geleegd en gereinigd worden; zie „Koffiedikreservoir legen“ pagina 90. Zolang het koffiedikreservoir niet gereinigd wordt, brandt het symbool en kan het apparaat geen koffie zetten.
- i** Tijdens de koffieafgifte nooit de watertank weghalen. Als de watertank weggehaald is, kan de koffiemachine geen koffie meer zetten. Om de koffiemachine te ontluchten draait u de draaiknop voor stoom en heet water zo ver mogelijk tegen de klok in naar de stand  en laat u enkele seconden lang water uit het stoompijpje lopen.
- i** Als u de koffiemachine de eerste keer in gebruik neemt, moet u minstens 4-5 koppen koffie zetten voordat de machine een bevredigend resultaat levert.



### 6.1 Tips voor afgifte van hete koffie:

- Als u meteen na het inschakelen van de koffiemachine de hoeveelheid koffie voor een klein kopje (minder dan 60 ml) wilt zetten, gebruik dan het hete water van het spoelproces om de kopjes te verwarmen.
- Stel een hogere koffietemperatuur in; zie „Koffietemperatuur instellen“ pagina 89.
- Gebruik geen te dikke kopjes, ook niet als ze voorverwarmd worden, want die absorberen te veel warmte.



- Gebruik voorverwarmde kopjes door ze met warm water te spoelen of minstens 20 minuten op het verwarmde afzetvlak voor kopjes (H) van de ingeschakelde koffiemachine te zetten.

## 7 Meerdere koppen koffie zetten met de kanfunctie

Met deze functie kunt u volautomatisch meerdere koppen koffie direct in de bijgeleverde roestvrijstalen warmhoudkan zetten: malen, portioneren, persen, voorkoken, zetten en uitwerpen van de verbruikte gemalen koffie zoals in de vorige paragraaf beschreven.

-  Draai de deksel van de bijgeleverde roestvrijstalen warmhoudkan in de stand voor het verwijderen (fig. 16) en haal de deksel eraf. Spoel de kan en de deksel.
-  Zet de deksel in de stand voor het schenken (afbeelding 17) op de warmhoudkan en zet deze onder de koffieuitloop (D). De koffieuitloop moet helemaal omhoog geschoven zijn om ruimte te maken voor de warmhoudkan.

Een van de symbolen voor de kanfunctie brandt, afhankelijk van het aantal koppen dat bij het laatste gebruik van de kanfunctie gekozen was. Bovendien branden de bladersymbolen "<" en ">". Het aantal koppen dat in de kan wordt afgegeven, wordt als volgt aangegeven:

-  4 koppen
-  6 koppen
-  8 koppen
-  10 koppen

-  Overtuig u ervan dat de watertank vol is, dat het bonenreservoir voldoende koffiebonen bevat en dat het koffiedikreservoir leeg is, om ervoor te zorgen dat er een aantal koppen koffie in de kan kunnen worden afgegeven.

(NL)

**i** Als u de koffiesterkte en de vulhoeveelheid voor de kanfunctie wilt veranderen, gebruikt u de draaiknop "Kopgrootte" (afbeelding 12) of de draaiknop "Koffiesterkte" (afbeelding 13) zoals beschreven in de paragraaf „Koffie zetten met bonen“ pagina 83.

**☞** Kies eventueel met de bladertoets "<" of ">" het symbool dat overeenkomt met het aantal koppen dat in de kan moet worden gezet, b.v.  voor 8 koppen.

**☞** Druk op de toets "Kan"  (afbeelding 18).



Tijdens het koffie zetten knippert het kansymbool voor het gekozen aantal koppen.

Als het koffie zetten afgelopen is, knipperen alle kansymbolen afwisselend, waarbij het symbool voor het gekozen aantal koppen twee keer zo lang brandt als de anderen symbolen.

**☞** Haal nu de warmhoudkan weg en sluit de deksel (fig. 19) om de koffie lang warm te houden.

Het apparaat gaat automatisch terug naar de koffiemodus.





**i** Als er te weinig koffiebonen zijn of de watertank te weinig water bevat om de gewenste functie te voltooien of het koffiedikreservoir vol is, onderbreekt het apparaat het proces en wordt het lopende programma afgebroken. Nadat de fout verholpen is, moet het programma opnieuw gestart worden. Daarbij moet u rekening houden met de hoeveelheid koffie die al in de kan aanwezig is, om te voorkomen dat de kan te vol wordt.

**i** Als de symbolen  en  knipperen, is de koffie te fijn gemalen. U moet de maalgraadinstelling veranderen; zie „Maalgraad instellen“ pagina 89.



## 8 Koffie zetten met poeder

Met deze functie kunt u reeds gemalen koffie, b.v. **cafeïnevrije koffie**, gebruiken.

**!** **Attentie!** Vergewis u ervan dat er geen poeder in de schacht achtergebleven is en er mogen ook geen vreemde elementen in de schacht komen. De vulschacht is geen voorraadreservoir, het poeder moet direct naar de koffietaanheid gaan.

**☞** Draai de draaiknop "Koffiesterkte / voorgemalen koffie" (afbeelding 20) in de gewenste stand  (voor 1 kop) of  (voor 2 koppen) om de functie voor voorgemalen koffie te kiezen. Daardoor wordt de koffiemolen buiten werking gesteld. Eén symbool  (voor 1 kop) of beide symbolen  (voor 2 koppen) branden.

**☞** Open de deksel van de poederschacht en doe de verse gemalen koffie erin (afbeelding 21).

Gebruik uitsluitend de bijgeleverde maatlepel. Doe er nooit meer dan 2 afgestreken maatlepels in, anders zet het apparaat geen koffie of wordt de gemalen koffie in het apparaat verspreid en vervuult het of wordt de koffie druppelsgewijs afgegeven en knipperen de symbolen  en .



Voeg tijdens het zetten geen gemalen koffie toe. Pas na afloop van het complete zetproces, als het apparaat weer gereed is, het poeder voor het volgende kopje erin doen. Doe nooit gemalen koffie in de machine wanneer deze uitgeschakeld is, anders wordt die in het apparaat verspreid.







**!** Gebruik alleen gemalen koffie voor volautomatische espressomachines. Geen koffiebonen, geen in water oplosbare, gevriesdroogde instantproducten en ook geen andere soorten drankpoeder in de schacht doen. Te fijn gemalen koffie kan tot verstoppingen leiden.

**i** Als de vulschacht verstopt is (ten gevolge van vocht in het apparaat of omdat er meer dan 2 maatlepels gemalen koffie in gedaan is), duwt u de gemalen koffie met een mes of de steel van een lepel omlaag (afbeelding 22). Verwijder dan de koffiezeteenheid en reinig deze samen met de koffiemachine zoals beschreven bij „Koffiezeteenheid reinigen“ pagina 91.

 Sluit de deksel.

 Kies de gewenste kopgrootte met de draaiknop "Kopgrootte" (afbeelding 12), zoals beschreven in de paragraaf „Koffie zetten met bonen“ pagina 83.

 Druk op de toets "1 kop koffie"  om één kopje te zetten of op de toets "2 koppen"  voor 2 kopjes. De koffie wordt gezet.

**i** Als de functie voor voorgemalen koffie voor 1 kop is gekozen en er geen gemalen koffie in de koffiopoederschacht is gedaan, knipperen na het drukken op de toets  de symbolen  . Als de functie voor voorgemalen koffie voor 2 koppen is gekozen en er geen gemalen koffie in de koffiopoederschacht is gedaan, knipperen na het drukken op de toets  de symbolen   en .



**i** Om na het zetten van de koffie terug te gaan naar de modus voor koffiebonen draait u de draaiknop "Koffiesterkte / voorgemalen koffie" (afbeelding 20) naar een willekeurige instelling voor de koffiesterkte (de koffiemolen kan dan weer gebruikt worden).



## 9 Melk opschuimen

De stoom kan gebruikt worden om melk op te schuimen of vloeistoffen te verhitten. Aangezien er voor het maken van stoom een hogere temperatuur nodig is dan voor koffie zetten, heeft het apparaat een aparte stoommodus.

**i** Voor een portie cappuccino vult u een groot kopje voor 1/2 tot 2/3 met espresso en doet u vervolgens de opgeschuimde melk erbij.



 **!** **Attentie! Verbrandingsgevaar als het stoompijpje actief is!** Uitstromend heet water of hete stoom kan tot brandwonden leiden. Activeer het stoompijpje daarom pas als het in de melk gedompeld is.

 Om stoom voor te bereiden drukt u op de toets "Stoom"  (afbeelding 23).

Het symbool  brandt en het apparaat wordt verwarmd. Tijdens het verwarmen knippert het symbool .

Na afloop van het verwarmingsproces brandt het symbool  continu. Het apparaat is klaar om melk op te schuimen.

**i** Als de stoomfunctie langer dan 2 minuten niet gebruikt wordt, schakelt het apparaat automatisch terug naar de koffiezetmodus.

**i** Om te voorkomen dat er bij het opschuimen overgebleven water door de melk wordt gemengd, moet u het water eerst laten weglopen. Houd hiervoor een bakje onder het stoompijpje en draai de draaiknop voor stoom en heet water (afbeelding 10) in de stand   tot er stoom ontstaat. Draai de draaiknop dan terug in de stand .

 Giet magere, koude melk in een beker die onder het stoompijpje van het apparaat past.

**i** De melk moet goed gekoeld zijn. Het kannetje moet ook koud zijn, het best van roestvrij staal, dus spoel het niet eerst met warm water uit.

 Draai het stoompijpje naar buiten en houd de beker zo onder het stoompijpje dat de opening van het pijpje net in de melk gedompeld is (afbeelding 24).

NL



**Attentie!** Gevaar van verontreiniging door opgedroogde melk in het stoompijpje. Let erop dat u het stoompijpje niet zo diep in de melk dompelt dat de luchtaanzuigopening aan de bovenkant van het stoompijpje met melk bedekt is. Hierdoor kan er melk in het pijpje gezogen worden, die evt. tot verontreiniging van het stoompijpje kan leiden.



Draai de draaiknop voor stoom en heet water (afbeelding 10) in de stand . De melk wordt opgeschuimd.



Om een romiger melkschuim te krijgen kunt u het kannetje langzaam van beneden naar boven bewegen. Schuim de melk minstens tot het dubbele volume op.



Het is aan te raden niet langer dan 2 minuten achter elkaar stoom te maken.



Om het opschuimen te beëindigen draait u de draaiknop voor stoom en heet water (afbeelding 10) naar de stand  en vervolgens verwijdert u het kannetje.



**Attentie!** Verbrandingsgevaar door spattende hete melk! Schakel de stoom uit voordat u het kannetje met de opgeschuimde melk wegtrekt.



Verlaat de stoommodus door op de toets "Stoom" (afbeelding 23) te drukken of wacht ca. 120 sec. tot het apparaat automatisch terugspringt naar de koffiemodus.

Het apparaat is nu weer gereed voor koffie zetten.



Laat na het opschuimen van melk in ieder geval nog even heet water door het pijpje naar buiten komen door de draaiknop voor stoom en heet water (afbeelding 10) in de stand  te draaien.

Dit is noodzakelijk om te voorkomen dat de melkresten in het pijpje opdrogen en het zo verstopten. Gebruik hiervoor een geschikt opvangbakje. Tijdens dit proces brandt het symbool .



Zet vervolgens de draaiknop voor stoom en heet water weer op de stand ; op de display verschijnt de laatst gekozen koffie-instelling.

## 9.1 Stoompijpje reinigen

**Belangrijk:** Om hygiënische redenen is het aan te raden het hierna beschreven proces elke keer na het opschuimen van melk uit te voeren. Zo voorkomt u dat er melk in het stoompijpje wordt afgezet.



Draai de draaiknop voor stoom en heet water met de klok mee helemaal door naar de stand . Wacht een paar minuten tot het stoompijpje afgekoeld is.



Pak daarvoor het zwenkbare pijpje bij de zwarte greep vast en open de bajonetssluiting door het stoompijpje iets tegen de klok in te draaien. Trek het stoompijpje omlaag weg (afbeelding 25).



Trek het binnendeel van het stoompijpje omlaag van het zwenkbare pijpje af.



Reinig het stoompijpje en het binnendeel met warm water.



Controleer of de twee in afbeelding 26 gemarkeerde gaten niet verstopt zijn. Steek ze indien nodig met een naald door en maak ze schoon.



Monteer het binnendeel weer door het voorzichtig op het zwenkbare pijpje te schuiven.



Monteer het stoompijpje weer door het weer op zijn plaats te schuiven en tegen de klok in te draaien.

## 10 Heet water maken

Het hete water kan gebruikt worden om kopjes voor te verwarmen en voor het maken van hete dranken, zoals thee of instant-soep.



**Attentie!** Verbrandingsgevaar als het heetwaterpijpje geactiveerd is! Uitstromend heet water kan tot brandwonden leiden. Activeer het heetwaterpijpje alleen als u een kopje



of bakje onder het heetwaterpijpe houdt.

-  Zet een bakje onder het heetwaterpijpe.
-  Draai de draaiknop voor stoom en heet water in de stand  (afbeelding 10). Er wordt heet water afgegeven; het symbool  brandt.

 Het is aan te raden niet langer dan 2 minuten achter elkaar heet water te maken.



-  Na de afgifte van heet water draait u de draaiknop voor stoom en heet water terug naar de stand  (afbeelding 10) en verwijdert u het bakje.

## 11 Maalgraad instellen

Het maalmechanisme is in de fabriek op een middelfijne maalgraad ingesteld. Als de koffieafgifte te snel of te langzaam (druppelsgewijs) is, kunt u de maalgraad tijdens het malen veranderen.

 De maalgraad mag alleen tijdens het malen veranderd worden, d.w.z. de knop voor de maalgraadinstelling (afbeelding 2, T en afbeelding 27) mag alleen gedraaid worden zolang het maalmechanisme tijdens het koffie zetten koffiebonen maalt. Instellen terwijl het maalmechanisme stilstaat, kan de koffiemachine beschadigen.

-  Stel de maalgraad met de knop voor de maalgraadinstelling (afbeelding 2, T) in (afbeelding 27).

- Als de koffie druppelsgewijs of helemaal niet wordt afgegeven (eventueel knipperen de symbolen  en ) , dan moet de knop één stand met de klok mee worden gedraaid. Draai telkens één stand verder tot er een bevredigende koffieafgifte bereikt is.
- Als de koffie te snel wordt afgegeven en de crema u niet bevalt, draait u de knop één stand tegen de klok in.

 Pas op dat u de knop voor de maalgraadinstelling niet te ver draait,

anders komt de koffie bij het zetten van 2 kopjes eventueel druppelsgewijs.















 Het effect van deze correcties merkt u echter pas na minstens 2 keer koffie zetten.

### Vreemde elementen uit het maalmechanisme verwijderen





Vreemde elementen in het maalmechanisme, zoals steentjes, kunnen het maalmechanisme beschadigen. Een vreemd element in de koffie veroorzaakt een gelijkmatig hard ratelend geluid. Als u dit geluid tijdens het malen hoort, schakel het apparaat dan meteen uit en neem contact op met de klantendienst. Als het maalwerk door een vreemd element geblokkeerd of beschadigd wordt, wordt dit eventueel niet door de garantie gedekt.

## 12 Koffietemperatuur instellen

U kunt kiezen uit drie temperaturniveaus. De fabriekinstelling is "Temperatuur hoog". U kunt de instelling als volgt veranderen:

-  Druk op de toets "P" (afbeelding 4). De symbolen "P" en  branden. Bovendien branden de 3 kleine symbolen boven de toetsen ,  en  om de momentele functie van de toetsen aan te geven; zie „Speciale modus“ pagina 81.
-  Druk op de bladertoetsen "<" of ">" (afbeelding 5) tot het symbool  brandt.
-  Bevestig met de toets "OK" (afbeelding 5). De display geeft de momentele instelling aan. De temperaturen worden als volgt aangegeven:
  -       Temperatuur laag
  -        Temperatuur medium
  -         Temperatuur hoog
-  Kies desgewenst met de bladertoetsen "<" of ">" (afbeelding 5) een andere temperatuur.







(NL)



-  Wanneer de gewenste taal wordt weergegeven, bevestigt u deze met de toets "OK" (afbeelding 5). Hiermee is deze temperatuur geprogrammeerd.
-  Om af te breken zonder opslaan drukt u op "P" in plaats van "OK".
-  Als er niet op "OK" wordt gedrukt, gaat het apparaat na ca. 120 seconden automatisch terug naar de koffiemo- dus, zonder de invoer op te slaan.
-  Om terug te gaan naar de koffiemo- dus drukt u vervolgens op de toets "P" (afbeelding 4) of wacht u ca. 120 sec. tot het apparaat automatisch terugspringt naar de koffiemo- dus.

## 13 Reiniging en verzorging

Houd uw apparaat altijd schoon om voor constante koffiekwaliteit en storingsvrije werking te zorgen.





### 13.1 Regelmatige reiniging

-  **Attentie!** Schakel het apparaat voor het reinigen uit. Laat het apparaat afkoelen.
-  **Attentie!** Was het apparaat of onderdelen van het apparaat nooit in de vaatwasmachine. Dompel de koffiema- chine nooit in water onder.
-  **Attentie!** Nooit water in het bonenre- servoir doen; daardoor wordt het maalmechanisme beschadigd.
-  Gebruiken geen krassende, schurende of bijtenden middelen. Veeg de ommanteling van binnen en van buiten alleen met een vochtige doek af.
-  Neem dagelijks de watertank (afbeel- ding 6) van het apparaat en giet het resterende water weg. Spoel de water- tank met schoon water uit. Gebruik dagelijks vers water.
-  Leeg het koffiedikreservoir dagelijks of uiterlijk wanneer er op de display om wordt gevraagd; zie „Koffiedikreser- voir legen" pagina 90.

-  Maak het afdruipbakje regelmatig leeg. Doe dit uiterlijk als de rode vlotter van het afdruipbakje (afbeelding 28) door de opening in het afdruiprooster te voorschijn komt.
-  Reinig regelmatig, minstens eens per week, watertank (N), afdruipbakje (O), afdruiprooster (A) en koffiedikreser- voir (Q) met warm water, mild afwas- middel en evt. een kwast.
-  Neem elke keer na het opschuimen van melk het stoompijpe van de machine en reinig dit grondig om melkresten te verwijderen; zie „Stoompijpe reini- gen" pagina 88.
-  Controleer of de openingen van de koffieuitloop niet verstopt zijn. Voor het schoonmaken kunt u de opge- droogde koffie met een naald verwij- deren (afbeelding 29).

### 13.2 Koffiedikreservoir legen

Het apparaat telt het aantal gezette koppen koffie. Na 14 apart (of 7 paars- gewijs) gezette koppen koffie brandt het symbool  om aan te geven dat het koffiedikreservoir vol is en geleegd en gereinigd moet worden. Zolang het koffiedikreservoir niet gereinigd wordt, kan de koffiemachine geen koffie zetten.

-  Ontgrendel voor het reinigen de servi- cedeur door op de daarvoor bestemde knop te drukken en open de service- deur (afbeelding 30); het symbool  brandt.
-  Het afdruipbakje eruit nemen (afbeel- ding 31), leeg maken en reinigen.
-  Maak het koffiedikreservoir zorgvuldig leeg en schoon. Let erop dat alle op de bodem achtergebleven resten verwij- derd worden.

**Belangrijk:** Elke keer als u het afdruip- bakje eruit trekt, moet ook het koffie- dikreservoir geleegd worden, ook als het niet helemaal vol is. Als dit niet wordt gedaan, kan het de volgende keer bij het koffie zetten gebeuren dat het koffiedikreservoir te vol wordt en het overtollige koffiedik de koffiema- chine verstopt.

**i** Wanneer u het afdruiptakje verwijderd hebt, knippert het symbool .

**i** Als u het apparaat dagelijks gebruikt, maak het reservoir dan ook dagelijks leeg. Maak het koffiedikreservoir alleen leeg terwijl het apparaat ingeschakeld is. Alleen dan detecteert het apparaat dat het geleegd wordt.

### 13.3 Maalmechanisme reinigen

Resten van gemalen koffie kunnen met een zachte kwast of een stofzuiger uit het bonenreservoir verwijderd worden.

**!** **Attentie!** Nooit water in het maalmechanisme doen; daardoor wordt het maalmechanisme beschadigd.

**☞** Schakel het apparaat met de toets "Aan/uit" (afbeelding 11) en de hoofdschakelaar (afbeelding 8) uit. Trek de stekker uit het stopcontact.

**☞** Verwijder de resterende koffiebonen (evt. stofzuiger met slang of spleetmondstuk gebruiken).

**i** Als vreemde elementen niet verwijderd kunnen worden, neem dan contact op met de klantendienst. Als het maalwerk door een vreemd element geblokkeerd of beschadigd wordt, wordt dit eventueel niet door de garantie gedekt.

**!** **Attentie!** Gevaar van letsel door het draaiende maalmechanisme. Schakel het apparaat nooit in als u aan het maalmechanisme werkt. Dit kan zeer ernstig letsel veroorzaken. Trek beslist de stekker uit het stopcontact.

**☞** Test nu met een kleine hoeveelheid bonen of het maalmechanisme goed werkt, door een kopje koffie te zetten. Bij de eerste maling of na het schoonmaken zal er minder gemalen koffie in de koffiezeteenheid komen, aangezien het kanaal gevuld moet worden. Dit kan invloed hebben op het eerste kopje koffie.

### 13.4 Koffiezeteenheid reinigen

Wij adviseren u de koffiezeteenheid (afhankelijk van de gebruiksfrequentie) regelmatig te reinigen. Voordat u het apparaat lang niet gebruikt (b.v. vakantie), is het noodzakelijk dat het koffiedikreservoir en de watertank geleegd worden en het apparaat incl. de koffiezeteenheid grondig wordt gereinigd.

Ga als volgt te werk:

**☞** Schakel de koffiemachine met de toets "Aan/uit" (afbeelding 11) uit (niet de stekker uit het stopcontact trekken) en wacht tot alle symbolen uit zijn!

**☞** Ontgrendel de servicedeur door op de daarvoor bestemde knop te drukken en open de servicedeur (afbeelding 30).

**☞** Het afdruiptakje eruit nemen (afbeelding 31) en reinigen.

**☞** De twee rode ontgrendelingsknoppen van de koffiezeteenheid opzij en naar het midden drukken (afbeelding 32) en de koffiezeteenheid eruit trekken.

**i** **Attentie:** De koffiezeteenheid kan er alleen uitgenomen worden als het apparaat met de toets "Aan/uit"  aan de voorkant van het apparaat uitgeschakeld is. De verbinding van het apparaat met het stroomnet mag niet verbroken worden. Als u probeert de koffiezeteenheid uit de koffiemachine te nemen terwijl deze ingeschakeld is, kan het apparaat ernstig beschadigd worden.

**☞** Reinig de koffiezeteenheid onder stromend leidingwater zonder afwasmiddelen te gebruiken. Was de koffiezeteenheid nooit in de vaatwasmachine.

**☞** De machine van binnen zorgvuldig reinigen. Krab de vastgekoekte koffieresten in de koffiemachine weg met een houten of plastic vork of iets anders dat geen krassen op het oppervlak maakt (afbeelding 33) en zuig alle resten met een stofzuiger weg (afbeelding 34).

**☞** Om de koffiezeteenheid weer in te zetten (afbeelding 36, a) deze in de hou-

NL

der (afbeelding 36, b) en de pen (afbeelding 36, c) schuiven. De pen moet in de buis (afbeelding 36, d) onder aan de koffiezeteenheid worden geschoven.

 Druk nu stevig op de tekst PUSH (afbeelding 36, e) tot de koffiezeteenheid hoorbaar vastklikt.

 Controleer nadat u het vastklikken hebt gehoord of de rode knoppen (afbeelding 36, f) naar buiten gekomen zijn, anders kan de servicedeur niet gesloten worden.

Afbeelding 37: de twee rode knoppen zijn correct naar buiten gekomen.

Afbeelding 38: de twee rode knoppen zijn niet naar buiten gekomen.

 Zet het afdruijbakje samen met het koffiedikreservoir weer in het apparaat.

 Sluit de servicedeur.

 Als de koffiezeteenheid niet correct is ingezet, d.w.z. tot het vastklikken te horen is, en de rode knoppen niet goed naar buiten zijn gekomen, kan het servicedeurtje niet gesloten worden.

 Als het inzetten van de koffiezeteenheid moeilijk gaat, moet deze (voor het inzetten) op de juiste hoogte worden gebracht, en wel door de koffiezeteenheid tegelijk van onderen en van boven, zoals in afbeelding 35 weergegeven, stevig samen te drukken.

 Als de koffiezeteenheid dan nog steeds moeilijk in te zetten is, sluit u de servicedeur, trekt u de stekker van het voedings snoer uit het stopcontact en steekt u hem weer in.

Wacht tot alle symbolen uit zijn, open dan de servicedeur en zet de koffiezeteenheid weer in.

### 13.5 Ontkalkingsprogramma uitvoeren

Met het ontkalkingsprogramma kunt u een eenvoudige en efficiënte ontkalking van uw apparaat uitvoeren. Wanneer het brandende symbool  u erop wijst, moet het apparaat ontkalkt worden.



 **Attentie:** Gebruik in geen geval ontkalkingsmiddelen die niet door AEG/Electrolux aanbevolen worden. Bij gebruik van andere ontkalkingsmiddelen aanvaardt AEG/Electrolux geen aansprakelijkheid voor eventuele schade. Vloeibaar ontkalkingsmiddel is verkrijgbaar in de vakhandel of via de servicelijn van AEG/Electrolux.



 Het ontkalkingsproces duurt ca. 45 minuten en mag niet onderbroken worden. Bij stroomuitval moet het programma opnieuw gestart worden.



 Voordat u het ontkalkingsprogramma start, reinigt u de koffiezeteenheid (zie „Koffiezeteenheid reinigen“ pagina 91).

 Druk op de toets "P" (afbeelding 4).

De symbolen "P" en  branden.

Bovendien branden de 3 kleine symbolen boven de toetsen ,  en  om de momentele functie van de toetsen aan te geven; zie „Speciale modus“ pagina 81.

 Druk op de bladertoetsen "<" of ">" (afbeelding 5) tot het symbool  brandt.



 Bevestig met de toets "OK" (afbeelding 5). De symbolen  en  knipperen en "P" brandt continu.



 Om het ontkalkingsprogramma hier af te breken, schakelt u het apparaat uit met de toets "Aan/uit"  (afbeelding 11).

 De watertank legen, met minstens 1 liter water vullen en het ontkalkingsmiddel toevoegen.



 **Attentie:** Zorg ervoor dat eventuele spatten van het ontkalkingsmiddel niet op zuurgevoelige oppervlakken zoals marmer, kalksteen en keramiek komen.



 Zet een bak met een inhoud van minstens 1,5 liter onder het stoompijpje (afbeelding 9)

 Zet de draaiknop voor stoom en heet water op de stand .

Het ontkalkingsprogramma start en de ontkalkingsvloeistof loopt uit het stoompijpje. Die Symbolen , und  "P" leuchten dauernd.

Het ontkalkingsprogramma doorloopt automatisch een serie spoelingen en pauzes om kalkafzettingen binnen in de koffiemachine te verwijderen.



Na ongeveer 30 minuten is de watertank leeg, de symbolen  en  knipperen en "P" brandt continu.



-  Zet de draaiknop voor stoom en heet water weer op de stand .



Het apparaat is nu klaar voor spoelen met vers water.



-  Neem de watertank eruit, vul die met vers water en zet hem weer in.

-  Maak de bak onder het stoompijpje leeg en zet hem er weer onder.

-  Zet de draaiknop voor stoom en heet water op de stand .

Er wordt met vers water gespoeld en het spoelwater loopt uit het stoompijpje. De symbolen ,  en "P" branden continu.

Na enkele minuten is de watertank leeg, de symbolen  en  knipperen en "P" brandt continu.

-  Zet de draaiknop voor stoom en heet water weer op de stand .

De symbolen behorend bij de laatst gekozen koffiemodus verschijnen en het symbool  brandt continu.

-  Maak de bak met spoelwater leeg.

-  Neem de watertank eruit, vul die met vers water en zet hem weer in.

Het apparaat is nu weer bedrijfsklaar en in de toestand van de laatst gekozen koffiemodus.

-  Wij raden u aan na het uitvoeren van het ontkalkingsprogramma het eerste kopje koffie weg te gooien.

## 14 Bestellen van accessoires

Om ervoor te zorgen dat u lang plezier hebt van uw apparaat en om voortijdige defecten te voorkomen is het zeer belangrijk dat het apparaat regelmatig gereinigd en ontkalkt wordt. De originele ontkalkingsmiddelen zijn ook direct bij ons verkrijgbaar.

Neem in Duitsland contact op met onze bestel-hotline:



1801 - 20 30 60\*

(\*Lokaal tarief vanuit vaste aansluitingen van Deutsche Telekom)



maandag t/m vrijdag 8.00 - 18.00 uur

## 15 Wat moet u doen als op de display de volgende melding verschijnt...

**Het symbool  brandt continu**

- De watertank is leeg of niet goed ingezet.
-  De watertank vullen en volgens de voorschriften inzetten; zie „Met water vullen“ pagina 81.
- De watertank is vuil of er hebben zich kalkkorsten gevormd.
-  De watertank uitspoelen of ontkalken.

**De symbolen  en  knipperen**

- De koffiemachine kan geen koffie zetten.
-  Zet een bak onder het stoompijpje en draai de draaiknop voor stoom en heet water tegen de klok in naar de stand  (afbeelding 9).
- De koffie komt te langzaam uit het apparaat.
-  Draai de knop voor de maalgraadinstelling (afbeelding 12) één positie met de klok mee zolang het maalmechanisme tijdens het koffie zetten koffiebonen maalt (zie „Maalgraad instellen“ pagina 89).

(NL)

**Het symbool ☒ brandt continu**

- Het koffiedikreservoir is vol.

 Het koffiedikreservoir zoals beschreven in „Koffiedikreservoir legen“ pagina 90 legen, reinigen en weer correct inzetten.

**Het symbool ☒ knippert**

- Het koffiedikreservoir is na het reinigen niet meer ingezet.

 Servicedeur openen en koffiedikreservoir inzetten.

**De symbolen ⚡ of ⚡⚡ en △ knippen**

- Na het kiezen van de functie voor voorgemalen koffie is er geen gemalen koffie in de vulschacht gedaan.

 Gemalen koffie erin doen zoals beschreven bij „Koffie zetten met poeder“ pagina 86.

**Alle symbolen voor de koffiesterkte ☉☉☉☉☉ en △ knippen**

- Het koffiebonereservoir bevat geen koffiebonen meer.

 Koffiebonereservoir vullen; zie „Koffiebonereservoir vullen“ pagina 81.

- Als het maalmechanisme een hard geluid produceert, kan dit betekenen dat een klein steentje tussen de koffiebonen het maalmechanisme geblokkeerd heeft.

 Neem contact op met de klantendienst. Als het maalwerk door een vreemd element geblokkeerd of beschadigd wordt, wordt dit eventueel niet door de garantie gedekt.

**Het symbool ☒ brandt continu**

- Geeft aan dat de koffiemachine verkalkt is.

 Het bij „Ontkalkingsprogramma uitvoeren“ pagina 92 beschreven ontkalkingsprogramma moet zo snel mogelijk worden uitgevoerd.

**Het symbool ☒ brandt continu**

- De servicedeur is open.

 De servicedeur sluiten. Als u de servicedeur niet kunt sluiten, controleer dan of de koffiezeteenheid correct is inge-

zet (zie „Koffiezeteenheid reinigen“ pagina 91).

**Het symbool △ knippert**

- Waarschijnlijk hebt u vergeten de koffiezeteenheid na het reinigen weer in de koffiemachine te plaatsen.

 De koffiezeteenheid inzetten; zie „Koffiezeteenheid reinigen“ pagina 91.

- De machine is van binnen erg vuil.

 De machine van binnen zorgvuldig reinigen; zie „Koffiezeteenheid reinigen“ pagina 91. Als de melding na het reinigen van de koffiemachine nog steeds verschijnt, neem dan contact op met de klantendienst.

**Het symbool △ brandt continu**

- Dit geeft een algemeen alarm aan.

 Neem contact op met de klantendienst.

**De symbolen ☒ en △ knippen**

- Het apparaat is ingeschakeld terwijl de draaiknop voor stoom en heet water in de stand "open" stond ☉☒.

 De draaiknop voor stoom en heet water helemaal met de klok mee (afbeelding 10) draaien tot de stand ●.

**De symbolen ↓ en △ knippen**

- De omgevingstemperatuur is te laag om het apparaat te gebruiken.

 Gebruik het apparaat op een warmere plaats.

## 16 Problemen die opgelost kunnen worden voordat u de klantendienst belt

Als de koffiemachine niet functioneert, kunt u de oorzaak van de storing gemakkelijk vinden en verhelpen door het hoofdstuk „Wat moet u doen als op de display de volgende melding verschijnt...“ pagina 93 te raadplegen. Als de koffiemachine echter geen symbool weergeeft, voer dan de volgende controles uit voordat u contact opneemt met de klantendienst.

**De koffie is niet heet**

- De kopjes zijn niet voldoende voorverwarmd.
- ☞ De kopjes voorverwarmen door ze met heet water te spoelen of minstens 20 minuten op het verwarmde afzetvlak voor kopjes (H) te zetten (zie „Tips voor afgifte van hetere koffie:“ pagina 85).

**De koffie heeft weinig crema**

- De koffie is te grof gemalen.
- ☞ Draai de knop voor de maalgraadinstelling één positie tegen de klok in zolang het maalmechanisme tijdens het koffie zetten koffiebonen maalt (zie „Maalgraad instellen“ pagina 89).
- Het koffiemengsel is niet geschikt.
- ☞ Gebruik een koffiemengsel dat geschikt is voor volautomatische koffiemachines.

**De koffie komt te langzaam uit het apparaat**

- De koffie is te fijn gemalen.
- ☞ Draai de knop voor de maalgraadinstelling één positie met de klok mee zolang het maalmechanisme tijdens het koffie zetten koffiebonen maalt (zie „Maalgraad instellen“ pagina 89).

**De koffie komt te snel uit het apparaat**

- De koffie is te grof gemalen.
- ☞ Draai de knop voor de maalgraadinstelling één positie tegen de klok in zolang het maalmechanisme tijdens het koffie zetten koffiebonen maalt (zie „Maalgraad instellen“ pagina 89).

**Er komt maar uit één opening van de koffieuitloop koffie**

- De gaten van de koffieuitloop zijn verstopt.
- ☞ Verwijder de opgedroogde koffie met een naald (afbeelding 29).

**Ondanks draaien aan de draaiknop voor stoom en heet water komt er geen stoom uit het stoompijpje**

- De gaatjes van het stoompijpje en het binnenste deel van het stoompijpje zijn verstopt.
- ☞ De gaatjes van het stoompijpje en het binnenste deel van het stoompijpje reinigen (zie „Stoompijpje reinigen“ pagina 88).

**Als de functie ☞ of ☞☞ gekozen is, komt er geen koffie, maar water uit de machine**

- De gemalen koffie is misschien vast blijven zitten in de vulschacht.
- ☞ Verwijder de gemalen koffie die de vulschacht verstopt met behulp van een mes (zie „Koffie zetten met poeder“ pagina 86) (afbeelding 22). Dan de koffiezeteenheid en de machine van binnen reinigen (zie „Koffiezeteenheid reinigen“ pagina 91).

**Als ik op de toets ① druk, wordt de machine niet ingeschakeld**

- De hoofdschakelaar aan de achterkant van het apparaat is niet ingeschakeld (afbeelding 8) of de stekker is niet in het stopcontact gestoken.
- ☞ Controleer of de hoofdschakelaar in de stand "I" staat en of het snoer goed in het stopcontact gestoken is.

**De koffiezeteenheid kan niet voor het reinigen uit de machine worden genomen**



- De koffiemachine is ingeschakeld. De koffiezeteenheid kan alleen uit de machine worden genomen als deze uitgeschakeld is.
- ☞ Apparaat uitschakelen en koffiezeteenheid eruit halen (zie „Koffiezeteenheid reinigen“ pagina 91).

- ⓘ **Attentie:** De koffiezeteenheid kan er alleen uitgenomen worden als het apparaat met de toets "Aan/uit" ① aan de voorkant van het apparaat uitgeschakeld is. De verbinding van het apparaat met het stroomnet mag niet verbroken worden. Als u probeert





(NL)

de koffiezeteenheid uit de koffiema-  
chine te nemen terwijl deze inge-  
schakeld is, kan het apparaat ernstig  
beschadigd worden.

**De koffie komt niet uit de openingen  
van de koffiuitloop, maar opzij uit  
de servicedeur**

- De openingen van de koffiuitloop zijn  
verstopt met opgedroogde koffie.
-  Verwijder de opgedroogde koffie met  
een naald (afbeelding 29).
- Het zwenkvak aan de binnenkant van  
het servicedeurtje (R) is geblokkeerd en  
draait niet.
-  Het zwenkvak zorgvuldig reinigen,  
vooral bij de scharnieren, zodat deze  
beweegbaar blijven.

**Er is gemalen koffie gebruikt (in  
plaats van koffiebonen) en de  
machine geeft geen koffie.**

- Er is te veel voorgemalen koffie in de  
machine gedaan.
-  De koffiezeteenheid uit de machine  
nemen en de machine zorgvuldig reini-  
gen zoals beschreven bij „Koffiezeteen-  
heid reinigen“ pagina 91. De procedure  
herhalen en daarbij maximaal  
2 afgestreeken maatlepels gemalen kof-  
fie gebruiken.
- De draaiknop "Koffiesterkte / voorgemalen  
koffie" is niet in de stand  of  
 gezet en het apparaat heeft  
zowel de voorgemalen koffie als de  
door het maalmechanisme gemalen  
koffie gebruikt.
-  De machine van binnen zorgvuldig rei-  
nigen, zoals beschreven bij „Koffiezet-  
eenheid reinigen“ pagina 91. De  
procedure herhalen, daarbij eerst de  
draaiknop "Koffiesterkte / voorgemalen  
koffie" in de juiste stand zetten, zoals  
beschreven bij „Koffie zetten met poe-  
der" pagina 86.
- De voorgemalen koffie is in de machine  
gedaan terwijl deze uitgeschakeld was.
-  De koffiezeteenheid uit de machine  
nemen en de machine zorgvuldig reinigen  
zoals beschreven bij „Koffiezeteen-

heid reinigen" pagina 91. Herhaal de  
procedure terwijl de machine inge-  
schakeld is.

**Wat moet u doen als het apparaat  
getransporteerd moet worden?**

- Originele verpakking als transportbe-  
scherming bewaren. Ter bescherming  
tegen krassen in ieder geval de oor-  
spronkelijke plastic zak gebruiken.
- Apparaat en warmhoudkan tegen  
schokken beveiligen. Voor schade tij-  
dens het transport aanvaarden wij  
geen aansprakelijkheid.
- Watertank en koffiedikreservoir leeg  
maken.
- Let er ook op waar u het apparaat  
plaatst, vooral in de winter. Er kan  
vorstschade ontstaan.



## 17 Statistiek-modus

Het apparaat biedt de mogelijkheid de  
volgende waarden op te roepen:

- het aantal van alle tot nu toe met  
het apparaat gezette kopjes koffie,
- het aantal gezette kannen met 4  
kopjes, 6 kopjes, 8 kopjes en 10 kop-  
jes,
- het aantal uitgevoerde ontkalkingen,  
en bovendien
- het aantal liters water dat door de  
machine is afgegeven.



 Als er 2 kopjes koffie tegelijk worden  
getapt, worden deze ook als 2 kopjes  
geteld.

Om de statistiek-modus in te schakelen  
moet het apparaat uitgeschakeld zijn.

 Schakel het apparaat, indien nodig,  
met de toets "Aan/uit"  uit (afbeel-  
ding 11).







 Druk minstens 6 seconden op de toets  
"P" (afbeelding 4).

De symbolen "P" en  branden.

Bovendien branden de 3 kleine symbo-  
len boven de toetsen ,  en   
om de momentele functie van de toets-  
sen aan te geven; zie „Speciale modus“  
pagina 81.







 Druk op de bladertoetsen "<" of ">" (afbeelding 5) tot het symbool brandt waarvoor de bijbehorende statistiek moet worden weergegeven:

-  Aantal gezette koppen koffie
-  Aantal uitgevoerde ontkalkingen
-  Aantal gezette kannen met 4 koppen
-  Aantal gezette kannen met 6 koppen
-  Aantal gezette kannen met 8 koppen
-  Aantal gezette kannen met 10 koppen
-  Aantal afgegeven liters water

Als een symbool brandt, kunt u het bijbehorende aantal als volgt laten weergeven:

 Toets "OK" indrukken en ingedrukt houden (afbeelding 5).





Nu beginnen de afzonderlijke weergaven achtereenvolgens te knipperen om het opgevraagde aantal aan te geven:

-  1 x knipperen betekent 1
-  1 x knipperen betekent 10
-  1 x knipperen betekent 100
-  1 x knipperen betekent 1,000
-  1 x knipperen betekent 10,000

De knippersignalen worden voortdurend herhaald zolang er op de toets "OK" wordt gedrukt. Voor elke herhaling wordt er een pauze van 3 seconden gemaakt.

 Tel het aantal van de afzonderlijke knippersignalen.

Voorbeeld: de volgende knipperserie komt overeen met het getal 1.529.

-  9 x knipperen
-  2 x knipperen
-  5 x knipperen
-  1 x knipperen
-  0 x knipperen

 Om de statistiek-modus te verlaten, drukt u minstens 6 seconden op de toets "P" (afbeelding 4).

## 18 Technische gegevens

Netspanning: 220-240 V  
Opgenomen vermogen: 1350 W

 Dit apparaat voldoet aan de volgende EG-richtlijnen:

- 73/23/EEG van 19-2-1973 "Laagspanningsrichtlijn", inclusief wijzigingsrichtlijn 93/68/EEG
- 89/336/EEG van 3-5-1989 "EMC-richtlijn", inclusief wijzigingsrichtlijn 92/31/EEG

(NL)

## 19 Afvalverwerking



### Verpakkingsmateriaal

De verpakkingsmaterialen zijn onschadelijk voor het milieu en herbruikbaar. De kunststoffen zijn voorzien van een aanduiding, b.v. >PE<, >PS< enz. Verwijder de verpakkingsmaterialen in overeenstemming met de aanduiding bij de gemeentelijke inzamelplaatsen in de daarvoor bestemde containers.



### Oude apparaten



Het symbool  op het product of op de verpakking wijst erop dat dit product niet als huishoudafval mag worden behandeld, maar naar een plaats moet worden gebracht voor recycling van elektrische en elektronische apparatuur. Als u ervoor zorgt dat dit product op de correcte manier wordt verwijderd, voorkomt u mogelijk voor mens en milieu negatieve gevolgen die zich zouden kunnen voordoen in geval van verkeerde afvalbehandeling. Voor meer details in verband met het recyclen van dit product kunt u het best contact opnemen met de gemeentelijke instanties, het bedrijf of de dienst belast met de verwijdering van huishoudafval of de winkel waar u het product hebt gekocht.

## 20 Service

De originele verpakking inclusief piepschuimdelen beslist bewaren. Om transportschade te voorkomen moet het apparaat veilig verpakt zijn.

Bij het opsturen van het apparaat altijd de warmhoudkan erbij doen. Deze is nodig voor het testen van het apparaat.

## I Gentile Cliente

La preghiamo di leggere attentamente le presenti istruzioni per l'uso, osservando in particolare le avvertenze di sicurezza! Si prega inoltre di conservare le presenti istruzioni per l'uso per consultarle in seguito e consegnarle ad un eventuale futuro proprietario dell'apparecchio.

### Indice

<b>1</b>	<b>Legenda</b>	<b>100</b>	<b>10</b>	<b>Preparazione d'acqua calda</b>	<b>111</b>
1.1	Vista dal davanti (figura 1)	100	<b>11</b>	<b>Regolare il grado di macinazione</b>	<b>111</b>
1.2	Vista dal davanti con portello di servizio aperto (figura 2)	100	<b>12</b>	<b>Regolare la temperatura del caffè</b>	<b>112</b>
1.3	Pannello di comando (figura 3)	100	<b>13</b>	<b>Pulizia e cura</b>	<b>112</b>
<b>2</b>	<b>Caffè ed espresso</b>	<b>101</b>	13.1	Pulizia regolare	112
<b>3</b>	<b>Avvertimenti per la sicurezza</b>	<b>101</b>	13.2	Svuotare il contenitore dei fondi	113
<b>4</b>	<b>Funzione speciale</b>	<b>103</b>	13.3	Pulire il macinino	113
<b>5</b>	<b>Prima messa in esercizio</b>	<b>103</b>	13.4	Pulire l'unità di bollitura	113
5.1	Sistemare l'apparecchio e collegarlo	103	13.5	Eeguire il programma di decalcificazione	114
5.2	Riempire l'acqua	103	<b>14</b>	<b>Ordinazione di accessori</b>	<b>116</b>
5.3	Riempire il contenitore dei chicchi di caffè	103	<b>15</b>	<b>Cosa occorre fare quando sul display appare i seguente simboli...</b>	<b>116</b>
5.4	Prima messa in funzione	104	<b>16</b>	<b>Problemi risolvibili, prima di chiamare il servizio dopo vendita</b>	<b>117</b>
5.5	Accendere l'apparecchio	104	<b>17</b>	<b>Funzione di statistica</b>	<b>119</b>
5.6	Spegnere l'apparecchio	105	<b>18</b>	<b>Dati tecnici</b>	<b>120</b>
5.7	Regolare la durezza dell'acqua	105	<b>19</b>	<b>Smaltimento</b>	<b>120</b>
<b>6</b>	<b>Preparare il caffè con chicchi</b>	<b>106</b>	<b>20</b>	<b>In caso di ricorso al servizio</b>	<b>120</b>
6.1	Consigli per l'erogazione di un caffè caldo	107			
<b>7</b>	<b>Preparare diverse tazze con la funzione bricco</b>	<b>107</b>			
<b>8</b>	<b>Preparare il caffè con la polvere di caffè</b>	<b>108</b>			
<b>9</b>	<b>Schiumare il latte</b>	<b>109</b>			
9.1	Pulire l'ugello del vapore	110			

I

## 1 Legenda















### 1.1 Vista dal davanti (figura 1)

- A Griglia raccogliogocce
- B Bricco per mantenere al caldo
- C Interruttore principale (lato posteriore dell'apparecchio)
- D Erogazione caffè regolabile in altezza
- E Pannello di comando (vedere figura 3)
- F Coperchio per contenitore dei chicchi di caffè
- G Coperchio del canale per caffè in polvere
- H Appoggio tazze riscaldato
- J Tubo orientabile per vapore e acquabollente
- K Ugello del vapore (asportabile)
- L Parte interna dell'ugello del vapore (asportabile)
- M Pulsante d'apertura per lo sportello di servizio
- N Serbatoio dell'acqua con indicazione del livello massimo (max) (asportabile)
- O Vaschetta raccogliogocce con galleggiante (asportabile)

### 1.2 Vista dal davanti con portello di servizio aperto (figura 2)

- P Portello di servizio (aperto)
- Q Contenitore raccolta fondi (estraibile)
- R Cassetto orientabile
- S Gruppo di bollitura
- T Pulsante per la regolazione del grado di macinatura
- U Contenitore dei chicchi di caffè
- V Misurino
- W Canale di riempimento del caffè premacinato
- X Targhetta delle caratteristiche (lato inferiore dell'apparecchio)
- Y Decalcificante liquido
- Z Strisce tornasole

### 1.3 Pannello di comando (figura 3)

- a Manopola "Intensità del caffè / caffè premacinato"
- b Manopola "dimensione tazza"
- c Display
- d Tasto "1 tazza da caffè"   
Nella funzione speciale questo tasto serve per "sfogliare" ("<")
- e Tasto "2 tazze da caffè"   
Nella funzione speciale questo tasto serve per "sfogliare" (">")
- f Tasto "vapore"   
Nella funzione speciale questo tasto conferma il punto del menu ("OK")
- g Tasto „P“  
Nella funzione speciale questo tasto ritorna all'ultimo livello, senza eseguire modifiche ("P")
- h Tasto "Ins/Dis" 
- j Manopola per vapore e acqua bollente
- k Tasto "Jug coffee function" 
- l Simboli "Caffè premacinato"
- m Simboli "Bricco"
- n Simboli "Intensità caffè"
- o Simboli "Dimensione tazza"
- p Simbolo "Serbatoio dell'acqua vuoto" 
- q Simbolo "Decalcificare" 
- r Simbolo "Temperatura apparecchio" 
- s Simbolo "Sportello di servizio aperto" 
- t Simbolo "Contenitore dei fondi" 
- u Simbolo "Attenzione" 
- v Simbolo "Acqua bollente" 
- w Simbolo "Vapore" 
- x Simbolo "Preparare 2 tazze" 
- y Simbolo "Preparare 1 tazza" 
- z Simboli per la funzione speciale

## 2 Caffè ed espresso

Le funzioni della sua macchina automatica le garantiscono un uso, semplicissimo per la preparazione del caffè ma anche durante la manutenzione e la cura.

Il gusto squisito e individuale si ottiene grazie

- al sistema di prebollitura: prima della bollitura principale, la polvere di caffè viene inumidita, per permetterle di sviluppate tutto il suo aroma
- il volume d'acqua regolabile individualmente per ogni tazza, da un espresso ristretto fino a un caffè "allungato" con cremetta,
- la temperatura del caffè regolabile individualmente, con la quale la macchina prepara il caffè,
- la possibilità di scegliere tra una tazza di caffè normale o forte,
- la finezza di macinazione regolabile in base alla torrefazione dei chicchi,
- e non per ultimo con la "cremetta" garantita, quella schiumetta che rende il caffè espresso tanto unico per l'intenditore.

**Inoltre:** Il periodo di contatto dell'acqua con la polvere di caffè, per il caffè espresso è notevolmente più breve rispetto all'usuale caffè filtrato. La polvere di caffè cede così molto meno sostanze amare, rendendo molto più gustoso il caffè espresso.

## 3 Avvertimenti per la sicurezza



La sicurezza di questo apparecchio corrisponde alle regole riconosciute dalla tecnica e dalla legge sulla sicurezza degli apparecchi. Ciò nonostante noi produttori dobbiamo ugualmente fare in modo che lei prenda confidenza con i seguenti avvertimenti sulla sicurezza.

### Sicurezza in generale

- L'apparecchio può essere collegato solo ad una rete elettrica, la cui tensione, tipo di corrente e frequenza corrispondono alle indicazioni riportate sulla targhetta delle caratteristiche (vedere lato inferiore dell'apparecchio)!
- Mai far entrare in contatto il cordone d'alimentazione con parti della macchina surriscaldate.
- Mai estrarre la spina dalla presa tirando dal cordone di alimentazione!
- Mai mettere in esercizio la macchina quando:
  - il cordone d'alimentazione è danneggiato oppure
  - l'involucro presenta danni visibili.
- Infilare la spina nella presa solo a macchina spenta.
- Questa macchina non è destinata all'uso o alla messa in esercizio da parte di persone (inclusi i bambini) che in seguito alla loro inesperienza o inconsapevolezza non sono in grado di usarla con sicurezza o da parte di persone (inclusi i bambini) con capacità fisiche, sensorie e psichiche limitate, eccetto quando vengono istruite nell'utilizzazione sicura della macchina, da una persona per loro responsabile e sorvegliate inizialmente da quest'ultima.

### Sicurezza dei bambini

- Mai far funzionare la macchina incustodita e nei confronti dei bambini attenersi sempre ad un particolare obbligo di sorveglianza.

I

- I materiali d'imballaggio, come per es. i sacchetti di plastica, non sono giocattoli per bambini.

#### Sicurezza durante l'esercizio

- **Attenzione!** L'erogatore del caffè, l'ugello del vapore e il ripiano per le tazze durante l'esercizio divengono roventi. Non far avvicinare i bambini
- **Attenzione!** Pericolo di ustioni con ugello del vapore attivato! L'acqua bollente erogata rispettiv. il vapore acqueo bollente possono provocare bruciature. Attivare l'ugello del vapore solo tenendo un contenitore sotto l'ugello del vapore
- Mai riscaldare liquidi infiammabili con il vapore!
- Attivare l'apparecchio solo se l'acqua è stata riempita nel sistema! Riempire il serbatoio dell'acqua solo con acqua fredda, non riempire con acqua calda, latte o altri liquidi. Osservare il volume di riempimento mass. di ca. 1,8 litri
- **Non caricare il contenitore dei chicchi con caffè a chicchi surgelato o caramellato. Usare solo chicchi di caffè torrefatti! Togliere i corpi estranei, per es. pietruzze, dai chicchi di caffè. Quando il macinino si blocca o viene danneggiato in seguito ad un corpo estraneo, eventualmente il danno non è coperto dalla garanzia.**
- Riempire l'apertura del caffè in polvere solo con caffè macinato.
- Mai lasciare l'apparecchio acceso inutilizzato.
- Non esporre l'apparecchio agli influssi atmosferici.
- Utilizzando un cavo di prolunga, servirsi unicamente di un cavo normalmente reperibile in commercio, con una sezione del conduttore minima di 1,5 mm<sup>2</sup>.
- Le persone che soffrono di disturbi motori non dovrebbero mai utilizzare da soli l'apparecchio, per evitare l'insorgere di pericoli.

- **Utilizzare l'apparecchio solo dopo che sono stati inseriti la vaschetta raccogliogocce, il contenitore dei fondi e la griglia raccogliogocce!**

#### Sicurezza durante la pulizia e la cura dell'apparecchio

- Attenersi alle istruzioni per la pulizia e la decalcificazione.
- Prima di eseguire la manutenzione o la pulizia, spegnere l'apparecchio e sfilare la spina dalla rete elettrica!
- Non immergere l'apparecchio nell'acqua.
- Pulire l'ugello del vapore solo con dispositivo spento, freddo e senza pressione!
- Non pulire parti dell'apparecchio nella lavastoviglie.
- **Mai versare acqua nel macinino, quest'ultimo ne verrebbe danneggiato.**



Non aprire né riparare l'apparecchio. Riparazioni inappropriate possono causare pericoli notevoli per l'utilizzatore. Le riparazioni agli apparecchi elettrici devono essere eseguite solo da personale specializzato.



Quando si rende eventualmente necessaria una riparazione, inclusa la sostituzione del cavo elettrico d'alimentazione, rivolgersi

- al commerciante specializzato, dal quale è stato acquistato l'apparecchio, oppure
- alla AEG/Electrolux Serviceline.

Quando si usa l'apparecchio per scopi diversi da quello a cui è destinato o si usa in modo sbagliato, non è possibile assumere responsabilità per eventuali danni o garanzie - lo stesso vale quando il programma di decalcificazione non viene eseguito immediatamente dopo l'accensione sul display del simbolo ☰ e non ci si attiene alle istruzioni contenute in queste istruzioni per l'uso. Se il macinino si blocca o viene danneggiato in seguito ad un corpo estraneo, eventualmente il danno non è coperto dalla garanzia

## 4 Funzione speciale

Per la regolazione della durezza dell'acqua („Regolare la durezza dell'acqua" pagina 105) e della temperatura del caffè („Regolare la temperatura del caffè" pagina 112), per avviare il programma di decalcificazione („Esegui il programma di decalcificazione" pagina 114) e per vedere la statistica („Funzione di statistica" pagina 119), si commuta alla funzione speciale premendo il tasto "P" (figura 4). Nella funzione speciale, i tasti "1 tazza da caffè" , "2 tazze da caffè" , "vapore"  e „P" servono per navigare. La rispettiva funzione è indicata sul display sopra il tasto (figura 5):

- «<» ("1 tazza di caffè" ) e «>» ("2 tazze di caffè" ) permettono di „sfogliare"
- «OK» ("vapore" ) conferma un punto
- «P» („P") ritorna all'ultimo livello, senza eseguire modifiche

## 5 Prima messa in esercizio

### 5.1 Sistemare l'apparecchio e collegarlo

Scegliere un appoggio adatto, orizzontale, stabile, non riscaldato, asciutto e resistente all'acqua.

-  Assicurare una buona circolazione dell'aria. Lateralmente e sul lato posteriore dell'apparecchio deve essere presente uno spazio libero di almeno 5 cm, e sopra l'apparecchio di almeno 20 cm. L'apparecchio non deve essere collocato in locali nei quali le temperature possono raggiungere 0 °C o meno (danneggiamento dell'apparecchio in seguito al congelamento dell'acqua).

-  Attenzione! Quando l'apparecchio proveniente da un ambiente freddo viene messo in un locale caldo, attendere circa 2 ore prima di accenderlo!

Consigliamo di appoggiare l'apparecchio su un sottofondo adatto, per evitare danneggiamenti in seguito a spruzzi.

-  Collegare l'apparecchio esclusivamente ad una presa con messa a terra. Non utilizzare una presa senza messa a terra.

### 5.2 Riempire l'acqua

Prima di accendere accertarsi che il serbatoio dell'acqua sia stato riempito e, se necessario, riempirlo. Ogni volta si accende rispettiv. si spegne, l'apparecchio consuma acqua per i processi automatici di risciacquo.

-  Prelevare il serbatoio dell'acqua dall'apparecchio (figura 6). Prima di prelevare il serbatoio dell'acqua, girare l'ugello del vapore sempre verso il centro dell'apparecchio, altrimenti non sarà possibile estrarre il serbatoio dell'acqua.

-  Riempire il serbatoio dell'acqua con acqua fredda fresca. Mai riempire eccessivamente il serbatoio dell'acqua superando la marca MAX.

-  Riempire il serbatoio dell'acqua solo con acqua fredda. Mai riempire altri liquidi come per es. acqua minerale o latte.

-  Reinscrivere il serbatoio dell'acqua (figura 6). Premere energicamente sul serbatoio, per aprire la valvola del serbatoio dell'acqua.

-  Per ottenere un caffè sempre aromatico, occorre:

- sostituire quotidianamente l'acqua del serbatoio,
- pulire il serbatoio dell'acqua lavandolo normalmente (non nella lavastoviglie) almeno una volta la settimana. Dopo risciacquare con acqua fresca.

### 5.3 Riempire il contenitore dei chicchi di caffè

-  Aprire il coperchio del contenitore dei chicchi di caffè e riempirlo con chicchi di caffè freschi (figura 7). Dopo richiudere il coperchio.

-  Attenzione! Non caricare il contenitore dei chicchi con caffè a chicchi surgelato o caramellato. Usare solo chicchi

I

di caffè torrefatti! Accertarsi che nel contenitore dei chicchi non si trovino corpi estranei, come per es. pietruzze. **Se il macinino si blocca o viene danneggiato in seguito ad un corpo estraneo, eventualmente il danno non è coperto dalla garanzia.**

**i** Il macinino è stato regolato in fabbrica ad una finezza di macinazione media. Se necessario, adattare questa regolazione. Informazioni su come cambiare la finezza di macinazione si trovano presso „Regolare il grado di macinazione“ pagina 111.

**!** Il grado di macinazione si può cambiare solo durante la macinazione. Regolazioni eseguite con macinino fermo possono danneggiare l'apparecchio.

**i** La macchina da caffè è stata controllata in fabbrica. A questo scopo è stato utilizzato del caffè, quindi è completamente normale trovare un po' di caffè nel macinino. In ogni caso si garantisce che la macchina da caffè è nuova.

#### 5.4 Prima messa in funzione

Quando prende per la prima volta in esercizio l'apparecchio, la macchina da caffè dev'essere sfiatata.

**☞** Attivare l'apparecchio con l'interruttore principale che si trova sul lato posteriore dell'apparecchio (figura 8). Accendendo per la prima volta la macchina con l'interruttore principale, si accendono per qualche secondo tutti i simboli del display per eseguire un autotest, dopo lampeggiano i simboli ☰ e △.

**☞** Riempire il serbatoio, vedere „Riempire l'acqua“ pagina 103.

**☞** Reinserrire il serbatoio dell'acqua (figura 6). Premere energicamente sul serbatoio, per aprire la valvola del serbatoio dell'acqua.

**☞** Girare l'ugello del vapore verso l'esterno e mettere una tazza sotto di esso (figura 9).

**☞** Girare la manopola del vapore e dell'acqua calda il più possibile in senso antiorario sulla posizione ☰☰ (figura 10).

Dall'ugello del vapore scendono alcune gocce d'acqua. I simboli ☰ e △ restano permanentemente accesi

Dopo riempita la tazza con circa 30 ml d'acqua, iniziano a lampeggiare i simboli ☰ e △.

**☞** Girare la manopola per il vapore e l'acqua calda il più possibile in senso orario sulla posizione ● (figura 10), per interrompere l'erogazione dell'acqua.

Il simbolo ☰ lampeggia per alcuni secondi e l'apparecchio si spegne.

**☞** Riempire il contenitore dei chicchi di caffè con i chicchi di caffè, vedere „Riempire il contenitore dei chicchi di caffè“ pagina 103

#### 5.5 Accendere l'apparecchio

Prima di accendere accertarsi che il serbatoio dell'acqua sia stato riempito e, se necessario, riempirlo. Ogni volta si accende rispettivamente si spegne, l'apparecchio consuma acqua per i processi automatici di risciacquo.

**☞** Accendere l'apparecchio con il tasto „Ins/Dis“ ○ (figura 11).

**i** Immediatamente dopo l'accensione l'apparecchio esegue la procedura d'attivazione. Questa procedura causa rumori ed è assolutamente normale.

**i** Durante il processo di riscaldamento (ca. 120 secondi) lampeggia il simbolo ☰.



Durante il riscaldamento l'apparecchio esegue un risciacquo automatico (un piccolo volume d'acqua calda fuoriesce dall'erogatore del caffè e viene raccolto nella vaschetta raccogli-gocce).

Dopo terminato il riscaldamento, il simbolo ☰ resta permanentemente acceso.

L'apparecchio è pronto per l'uso. Sono accesi i simboli conformi all'ultima funzione di erogazione di caffè selezionata.



## 5.6 Spegnere l'apparecchio

-  Spegnere l'apparecchio con il tasto „Ins/Dis“  (figura 11). Il simbolo  lampeggia. L'apparecchio esegue un processo di risciacquo e si spegne.

-  Quando l'apparecchio non viene utilizzato per un periodo di tempo prolungato, per motivi di risparmio energetico si spegne automaticamente dopo 3 ore.

-  Quando l'apparecchio resta inutilizzato per un periodo di tempo prolungato, dopo il disinserimento con il tasto "Ins/Dis" si dovrebbe spegnere anche con l'interruttore principale sul lato posteriore dell'apparecchio (fig. 8).

## 5.7 Regolare la durezza dell'acqua

Dopo la prima messa in esercizio oppure cambiando la qualità d'acqua utilizzata l'apparecchio dovrebbe essere regolato sul grado di durezza dell'acqua, corrispondente alla durezza dell'acqua locale. Utilizzare il bastoncino tornasole allegato per determinare il grado di durezza, oppure chiedere la durezza dell'acqua alla centrale idrica locale.

### Determinare il grado di durezza dell'acqua

-  Immergere la striscia tornasole per ca. 1 secondo nell'acqua fredda. Scuotere l'acqua in eccesso e determinare il grado di durezza in base ai campi colorati di rosa.

 Nessun campo oppure un campo color rosa:

**Grado di durezza 1, LEGGERO**  
fino a 1,24 mmol/l, rispettiv.  
fino a 7° tedeschi di durezza,  
rispettv.  
fino a 12,6° di durezza francesi



**Due campi rosa:**  
**Grado di durezza 2, durezza media**  
fino a 2.5 mmol/l, rispettiv.  
fino a 14° tedeschi di durezza,  
rispettv.  
fino a 25.2° di durezza francesi



**Tre campi rosa:**

**Grado di durezza 3, dura**  
fino a 3.7 mmol/l, rispettiv.  
fino a 21° tedeschi di durezza,  
rispettv.

fino a 37.8° di durezza francesi



**Quattro campi rosa:**

**Grado di durezza 4, molto dura**  
oltre 3.7 mmol/l, rispettiv.





oltre 21° tedeschi di durezza,  
rispettv.

oltre 37.8° di durezza francesi

### Regolare e salvare il grado di durezza dell'acqua determinato

Si possono regolare 4 gradi di durezza. In fabbrica l'apparecchio è stato regolato sul grado di durezza 4.

-  Premere il tasto "P" mentre l'apparecchio è acceso (figura 4).

I simboli "P" e  sono accesi. Inoltre sono accesi i 3 piccoli simboli sopra le tazze ,  e , per indicare la funzione momentanea di queste tazze, vedere „Funzione speciale“ pagina 103

-  Confermare la selezione con il tasto "OK" (figura 5).

Il display indica la regolazione attuale. I gradi di durezza vengono indicati come segue:



Grado di durezza 1

Grado di durezza 2

  

Grado di durezza 3

Grado di durezza 4

-  Premere poi i tasti sfogliare "<" oppure ">" (figura 5) così tante volte, fino a quando verrà visualizzata la durezza dell'acqua determinata.

-  Confermare la selezione con il tasto "OK" (figura 5). Questo grado di durezza è adesso programmato

-  Per interrompere senza memorizzare, premere "P" invece di "OK".

Non premendo "OK", l'apparecchio ritorna dopo ca. 120 secondi automaticamente alla funzione caffè, senza memorizzare le impostazioni.

1

- ☞ Per ritornare alla funzione caffè, premere conclusivamente il tasto "P" (figura 4) oppure attendere ca. 120 sec., fino a quando l'apparecchio torna automaticamente alla funzione caffè.

## 6 Preparare il caffè con chicchi

Durante la preparazione del caffè con chicchi di caffè, il seguente processo si svolge **automaticamente**: Macinare, porzionare, comprimere, prebollire, bollire ed espellere la polvere di caffè consumata.





Grazie alla capacità di regolare il grado e il volume di macinazione, l'apparecchio può essere regolato individualmente per soddisfare i gusti personali.

- ⚠ Non caricare il contenitore dei chicchi con caffè a chicchi surgelato o caramellato. Usare solo chicchi di caffè torrefatti! Accertarsi che nel contenitore dei chicchi non si trovino corpi estranei, come per es. pietruzze. Se il macinino si blocca o viene danneggiato in seguito ad un corpo estraneo, eventualmente il danno non è coperto dalla garanzia.

A seconda dei gusti, scegliere un espresso "ristretto" oppure un caffè crema "allungato".

- ☞ Scegliere la grandezza della tazza desiderata con la manopola "Grandezza tazza" (figura 12). Viene indicata la grandezza della tazza desiderata.

- i** Le grandezze delle tazze vengono indicate come segue:





	Tazza espresso
	Tazza piccola
	Tazza media
	Tazza grande
	Bicchiere

Il caffè può essere scelto con aroma extra leggero, leggero, normale, forte o extra forte.



- ☞ Scegliere l'intensità dell'aroma del caffè desiderata con la manopola



"Intensità caffè" (fig. 13). Viene indicata l'intensità del caffè desiderata.



- i** L'intensità del caffè viene indicata come segue:



	extra leggero
	leggero
	normale
	forte
	extra forte



- ☞ Porre una o due tazze sotto l'erogatore del caffè (figura 14). Facendo scorrere verso l'alto o il basso l'erogatore, si adatta in modo ottimale l'altezza dell'erogatore all'altezza della tazza, per ridurre perdite di calore ed evitare spruzzi di caffè (fig. 15).

- ☞ Premere il tasto "1 tazza di caffè"  per preparare una tazza, oppure il tasto "2 tazze"  per 2 tazze.



Il simbolo "1 tazza"  oppure "2 tazze"  è acceso. Adesso l'apparecchio macina i chicchi. Per preparare il caffè, la polvere di caffè viene inizialmente inumidita per la prebollitura con una piccola quantità d'acqua. Dopo una breve interruzione avviene il vero e proprio processo di bollitura. Il caffè viene adesso erogato nella tazza.

Dopo erogato il volume di caffè desiderato, l'apparecchio termina automaticamente l'erogazione ed espelle nel contenitore dei fondi la polvere di caffè consumata. Durante questo periodo il simbolo "1 tazza"  oppure "2 tazze"  lampeggia



- ☞ È possibile interrompere anticipatamente l'erogazione del caffè, premendo un attimo sul tasto "1 tazza"  oppure "2 tazze" , oppure girando la manopola "dimensione tazza" (figura 12) in senso antiorario in direzione "tazza espresso".

- ☞ Terminata l'erogazione del caffè, si può aumentare il volume del caffè premendo e tenendo premuto il tasto "1 tazza"  oppure "2 tazze" , fino ad ottenere il volume di caffè desiderato, oppure girando il pulsante a manopola "Dimensione tazza" (figura 12) in senso

orario in direzione "bicchiere" (questa operazione deve avvenire immediatamente dopo l'erogazione del caffè e prima che la polvere di caffè consumata venga espulsa nel contenitore dei fondi).

Dopo alcuni secondi, quando si spegne il simbolo "1 tazza"  oppure "2 tazze" , l'apparecchio è nuovamente pronto all'esercizio e si può preparare il prossimo caffè.

**i** Se il caffè fuoriesce a gocce o non fuoriesce completamente, oppure quando il caffè fuoriesce troppo velocemente e la "cremetta" erogata non è del gusto desiderato, allora occorre modificare il grado di macinazione, vedere „Regolare il grado di macinazione" pagina 111

**i** Quando lampeggiano i simboli  e  polvere del caffè è stata macinata troppo fine. Dovrebbe cambiare il grado di macinazione, vedere „Regolare il grado di macinazione" pagina 111.

**i** Quando si accende il simbolo , occorre riempire il serbatoio dell'acqua, altrimenti l'apparecchio non è in grado di preparare il caffè. (È normale che nel serbatoio dell'acqua si trovi ancora un po' d'acqua, quando si accende il simbolo).

**i** Quando il simbolo  è acceso, il contenitore dei fondi è pieno e dev'essere svuotato nonché pulito, vedere „Svuotare il contenitore dei fondi" pagina 113. Fintanto il contenitore dei fondi non sarà pulito, il simbolo resta acceso e la macchina da caffè non può preparare caffè.

**i** Mai estrarre il serbatoio dell'acqua durante l'erogazione del caffè. Se si toglie, la macchina da caffè non è in grado di preparare il caffè. Per sfiatare la macchina da caffè, si prega di girare la manopola del vapore e dell'acqua bollente in senso antiorario il più possibile nella posizione , e far scorrere per alcuni secondi acqua dall'ugello del vapore.

**i** Alla prima messa in esercizio della macchina da caffè occorre preparare almeno 4-5 caffè, prima che la macchina fornisca un risultato soddisfacente.

## 6.1 Consigli per l'erogazione di un caffè caldo

- Quando si desidera preparare una tazza di caffè piccola (meno di 60 ml) subito dopo accesa la macchina, utilizzare l'acqua calda del processo di lavaggio per preriscaldare le tazze.
- Regolare una temperatura del caffè più alta, vedere „Regolare la temperatura del caffè" pagina 112
- Non utilizzare tazze troppo spesse, eccetto quando vengono preriscaldate, perchè assorbono troppo calore.
- Utilizzare tazze preriscaldate, sciacquandole con acqua calda o appoggiandole almeno 20 minuti sul ripiano per tazze (H) riscaldato della macchina da caffè accesa.

## 7 Preparare diverse tazze con la funzione bricco

Questa funzione permette di preparare automaticamente diverse tazze di caffè, direttamente nel bricco in acciaio inossidabile per mantenere al caldo, compreso nella fornitura : Macinare, porzionare, comprimere, prebollire, bollire ed espellere la polvere di caffè consumata come descritto al capitolo precedente.

 Girare il coperchio del bricco in acciaio inossidabile per mantenere al caldo compreso nella fornitura nella posizione di prelievo (fig. 16) e togliere il coperchio. Sciacquare il bricco e il coperchio.

 Posizionare il coperchio nella posizione d'erogazione (figura 17) sul bricco per mantenere al caldo e porre quest'ultimo sotto l'erogatore del caffè (D). L'erogatore del caffè deve essere

1

fatto scorrere completamente in alto, per permettere di inserire il bricco per mantenere al caldo.

È acceso uno dei simboli per la funzione bricco, a seconda del numero di tazze selezionato durante l'ultima utilizzazione della funzione bricco. Inoltre sono accesi i simboli sfogliare "<" e ">". Il numero di tazze erogato nel bricco, è indicato come segue:

 4 tazze



 6 tazze



 8 tazze

 10 tazze

 Sincerarsi che il serbatoio dell'acqua sia pieno, che il contenitore dei chicchi sia sufficientemente riempito con chicchi di caffè e che il contenitore dei fondi sia vuoto, per preparare una serie di caffè nel bricco.

 Desiderando modificare l'intensità del caffè e il volume di riempimento per la funzione bricco, utilizzare il pulsante a manopola "Dimensione tazza" (figura 12) rispettiv. il pulsante a manopola "Intensità caffè" (figura 13), come descritto al capitolo „Preparare il caffè con chicchi" pagina 106.

 Scegliere eventualmente con i tasti sfogliare "<" oppure ">" il simbolo corrispondente alla quantità di tazze da preparare con il bricco, per es.  per 8 tazze.



 Premere il tasto "Jug"  (Figura 18). Durante la preparazione del caffè lampeggia il simbolo del bricco corrispondente alla quantità di tazze selezionata.

Dopo terminato il processo di bollitura, i simboli del bricco lampeggiano alternativamente, mentre il simbolo corrispondente alla quantità di tazze selezionata lampeggia per il doppio del tempo rispetto agli altri simboli.

 Prelevare adesso il bricco per mantenere al caldo e chiudere il coperchio (fig. 19), per mantenere a lungo caldo il caffè.

L'apparecchio ritorna automaticamente alla funzione caffè.





 Quando è stato riempito un quantitativo insufficiente di chicchi di caffè o l'acqua nel serbatoio non è sufficiente, per concludere la funzione desiderata, oppure quando il contenitore dei fondi è pieno, l'apparecchio arresta il processo e il programma in corso si interrompe. Dopo aver rimediato all'errore, il programma deve essere avviato nuovamente. In tal caso occorre considerare il volume di caffè che già si trova nel bricco, per non far traboccare il bricco.

 Quando lampeggiano i simboli  e  la polvere del caffè è stata macinata troppo fine. Occorrerebbe cambiare il grado di macinazione, vedere „Regolare il grado di macinazione" pagina 111.

## 8 Preparare il caffè con la polvere di caffè

Questa funzione permette di preparare caffè già macinato, per es. **caffè decaffeinato**.

 **Attenzione!** Accertarsi che la polvere di caffè non resti attaccata al canale di riempimento, inoltre che corpi estranei non entrino nel canale. Il canale di riempimento non è un serbatoio, la polvere deve entrare direttamente nell'unità di bollitura.

 Girare la manopola "intensità del caffè / caffè premacinato" (figura 20) nella posizione desiderata  (per 1 tazza) oppure  (per 2 tazze), per scegliere la funzione per la polvere di caffè premacinata. È acceso un simbolo  (per 1 tazza) oppure entrambi i simboli  (per 2 tazze).

 Aprire il coperchio del canale di riempimento della polvere di caffè e riempire con polvere di caffè fresco (figura 21). Utilizzare unicamente il misurino compreso nella fornitura. Mai riempire più di 2 misurini rasi, altrimenti l'apparec-

chio o non prepara il caffè, il caffè in polvere viene distribuito all'interno dell'apparecchio, sporcandolo, oppure il caffè sarà erogato a gocce e lampeggiano i simboli ☹ e ⚠.

Non riempire caffè in polvere durante la bollitura del caffè. Riempire il caffè in polvere per la prossima tazza solo dopo terminato il completo processo di bollitura, quando l'apparecchio è nuovamente pronto all'esercizio. Mai riempire polvere di caffè a macchina spenta, altrimenti verrà distribuita all'interno dell'apparecchio.

 Usare solo caffè in polvere destinato a macchine espresso automatiche. Mai riempire il canale con chicchi di caffè, e nemmeno con prodotti istantanei, liofilizzati, solubili in acqua, e con nessun altro prodotto in polvere per bevande. Caffè in polvere troppo fine può causare intasamenti.

 Quando il canale di riempimento è intasato (in seguito ad umidità nell'apparecchio, oppure perché sono stati riempiti più di 2 misurini di caffè in polvere), usare un coltello o il gambo di un cucchiaino per spostare la polvere verso il basso (figura 22). Prelevare poi l'unità di bollitura e pulirla assieme alla macchina da caffè, come descritto presso „Pulire l'unità di bollitura" pagina 113.

 Chiudere il coperchio.

 Scegliere la grandezza della tazza desiderata con il pulsante a manopola "Grandezza tazza" (figura 12), come descritto al capitolo „Preparare il caffè con chicchi" pagina 106.

 Premere il tasto "1 tazza di caffè" ☐ per preparare una tazza, oppure il tasto „2 tazze" ☐ per 2 tazze. Il caffè viene preparato.

 Quando è stata selezionata la funzione per il caffè in polvere premacinato per 1 tazza, ma la polvere di caffè non è stata versata nel canale per caffè in polvere, dopo premuto il tasto ☐ lampeggiano i simboli ☹ e ⚠. Quando è

stata selezionata la funzione per il caffè in polvere premacinato per 2 tazze, ma la polvere di caffè non è stata versata nel canale per caffè in polvere, dopo premuto il tasto ☐ lampeggiano i simboli ☹ ☹ e ⚠.

 Dopo preparato il caffè, per ritornare alla funzione chicchi di caffè, girare la manopola "intensità caffè / caffè premacinato" (figura 20) su una regolazione qualsiasi per l'intensità dell'aroma del caffè (ora è nuovamente possibile l'esercizio del macinino del caffè).

## 9 Schiumare il latte

Il vapore può essere utilizzato per schiumare il latte e per riscaldare liquidi. Per produrre vapore è necessaria una temperatura più alta rispetto a quella necessaria per la preparazione del caffè, l'apparecchio dispone per questo di una funzione vapore supplementare.

 Per una porzione di cappuccino, riempire una tazza grande da 1/2 a 2/3 con caffè espresso e aggiungere poi il latte schiumato.

 Attenzione! Pericolo di scottature quando l'ugello del vapore è stato attivato! L'acqua bollente erogata rispettivamente il vapore acqueo bollente possono provocare bruciature. Attivare quindi l'ugello del vapore solo dopo che sarà immerso nel latte.

 Per produrre il vapore premere il tasto "vapore" (figura 23).

Il simbolo ☹ è acceso e l'apparecchio si riscalda. Durante il riscaldamento lampeggia il simbolo ↓.

Dopo terminato il processo di riscaldamento, il simbolo ↓ resta permanentemente acceso. L'apparecchio è pronto per schiumare il latte.

 Utilizzando la funzione vapore per una durata superiore ai 2 minuti, l'apparecchio ritorna automaticamente alla funzione caffè.





1

- i** Per evitare che durante la schiumatura venga mischiata al latte dell'acqua residua, conviene far fuoriuscire precedentemente l'acqua. Per fare questo tenere un recipiente sotto l'ugello del vapore e girare la manopola del vapore e acqua calda (figura 10) nella posizione ☺☻ fino a quando fuoriesce il vapore. Girare poi indietro la manopola di selezione nella posizione ●.
- ☞ Versare latte freddo, povero di grasso, in un bicchiere che deve poter entrare sotto l'ugello del vapore dell'apparecchio.
- i** Il latte dovrebbe essere ben freddo. Inoltre conviene utilizzare un recipiente freddo, preferibilmente un bicchiere d'acciaio inossidabile, che non è stato precedentemente sciacquato con acqua calda.
- ☞ Girare l'ugello del vapore verso l'esterno e tenere il bicchiere sotto l'ugello del vapore, in modo che l'apertura dell'ugello si trovi appena immersa nel latte (figura 24).
- !** **Attenzione!** Pericolo della formazione di impurità in seguito al latte essiccato nell'ugello del vapore. Fare attenzione a non immergere l'ugello del vapore nel latte fino al punto da coprire con il latte l'apertura d'aspirazione dell'aria sul lato terminale superiore dell'ugello del vapore. In tal caso il latte può essere aspirato nell'ugello del vapore e causare ev. impurità nell'ugello del vapore.
- ☞ Girare la manopola del vapore e l'acqua calda (figura 10) nella posizione ☺☻. Ora avviene la formazione di schiuma nel latte.
- i** Per ottenere una schiumatura cremosa del latte, muovere il recipiente lentamente dal basso verso l'alto. Schiumare il latte minimo fino ad ottenere il doppio volume.
- i** Si consiglia di non prelevare il vapore ininterrottamente per oltre 2 minuti.
- ☞ Per terminare la schiumatura, girare la manopola del vapore e acqua calda (figura 10) nella posizione ● e prelevare dopo il contenitore.
- !** **Attenzione!** Pericolo di scottature causate da spruzzi di latte bollente! Spegner il vapore, prima di estrarre il contenitore con il latte schiumato.
- ☞ Abbandonare la funzione del vapore, premendo il tasto "vapore" (figura 23) oppure attendere ca. 120 sec., fino a quando l'apparecchio torna automaticamente alla funzione caffè.
- L'apparecchio è nuovamente pronto per la preparazione del caffè.
- ☞ Dopo schiumato il latte, fare assolutamente uscire ancora acqua bollente dall'ugello, girando la manopola del vapore e acqua bollente (figura 10) nella posizione ☺☻.
- Questa operazione è necessaria per escludere che resti di latte essiccino all'interno dell'ugello, intasandolo. A questo scopo, usare un recipiente adeguato. Durante questo processo è acceso il simbolo ☻☻.
- ☞ Dopo regolare la manopola per vapore e acqua calda nuovamente nella posizione ●, nel display appare la regolazione del caffè fatta per ultimo.

### 9.1 Pulire l'ugello del vapore









**Importante:** Per motivi igienici si consiglia di eseguire la procedura susseguentemente descritta ogni volta dopo aver schiumato il latte. Con ciò si evita che il latte si depositi all'interno dell'ugello del vapore.

- ☞ Girare la manopola del vapore e acqua calda in senso orario fino a fine corsa, nella posizione ●. Attendere alcuni minuti, fino a quando l'ugello del vapore si sarà raffreddato.
- ☞ Afferrare adesso il tubo orientabile prendendolo dall'impugnatura nera e aprire l'innesto a baionetta dell'ugello del vapore eseguendo una piccola rotazione in senso orario. Estrarre l'ugello del vapore tirandolo verso il basso (figura 25).

-  Tirare la parte interna dell'ugello del vapore verso il basso togliendola dal tubo orientabile.
-  Pulire con acqua calda l'ugello del vapore e la parte interna.
-  Controllare che i due fori contrassegnati nella fig. 26 non siano intasati. Eventualmente aprirli con uno spillo e pulirli.
-  Rimontare la parte interna, infilandola con attenzione sul tubo orientabile.
-  Montare nuovamente l'ugello del vapore, infilandolo nuovamente e girandolo in senso antiorario.

## 10 Preparazione d'acqua calda

L'acqua calda si può utilizzare per preriscaldare le tazze e per preparare bevande calde, come ad es. il tè o le minestre pronte per l'uso.

-  **Attenzione!** Pericolo di ustioni quando l'ugello dell'acqua calda è stato attivato! L'acqua bollente che fuoriesce può causare bruciature. Attivare l'ugello del l'acqua bollente solo tenendo un contenitore sotto l'ugello dell'acqua bollente.
-  Porre un recipiente sotto l'ugello dell'acqua bollente.
-  Girare la manopola del vapore e l'acqua calda nella posizione  (figura 10). L'acqua bollente viene erogata; è acceso il simbolo .
-  Si consiglia di non prelevare l'acqua bollente ininterrottamente per oltre 2 minuti.
-  Dopo prelevata l'acqua bollente girare indietro la manopola del vapore e dell'acqua bollente nella posizione  (figura 10) e togliere il contenitore.

## 11 Regolare il grado di macinazione

Il macinino è stato regolato in fabbrica ad un grado di macinazione medio. Se l'erogazione del caffè dovesse avvenire troppo velocemente o troppo lenta-



mente (a gocce), il grado di macinazione può essere cambiato durante la macinazione.



**Il grado di macinazione può essere modificato solo durante il processo di macinazione, cioè, il pulsante per la regolazione del grado di macinazione (figura 2, T e figura 27) può essere girato solo fintanto il macinino macina i chicchi di caffè durante la preparazione del caffè. Regolazioni eseguite a macinino fermo possono danneggiare la macchina da caffè.**



Regolare il grado di macinazione con la manopola per la regolazione del grado di macinazione (figura 2, T) (figura 27).

- Quando il caffè fuoriesce a gocce o non fuoriesce completamente (è possibile che lampeggino i simboli  e ), occorre girare il pulsante di una posizione in senso orario. Girare sempre di una sola posizione alla volta, fino ad ottenere un'erogazione del caffè soddisfacente.
- Se l'erogazione del caffè avviene troppo velocemente e la premetta non del gusto desiderato, girare la manopola in senso antiorario indietro di una posizione.



Fare attenzione a non girare troppo la manopola per la regolazione del grado di macinazione altrimenti, desiderando erogare 2 tazze di caffè, questo potrebbe eventualmente fuoriuscire a gocce.



L'effetto di queste correzioni si vede però solamente dopo almeno 2 preparazioni susseguenti di caffè.

### **Togliere i corpi estranei dal macinino**

I corpi estranei che entrano nel macinino, come per es. del pietrisco, possono danneggiare il macinino. Un corpo estraneo nel caffè causa un rumore uniforme simile ad uno strepito. Se durante la macinazione si dovesse udire un simile rumore, spegnere immediatamente l'apparecchio e rivolgersi al servizio dopo vendita. **Se il macinino si blocca o viene danneg-**





I



giato in seguito ad un corpo estraneo, eventualmente il danno non è coperto dalla garanzia.

## 12 Regolare la temperatura del caffè



Si può scegliere tra tre diversi livelli di temperatura. La regolazione di fabbrica è "Temperatura alta". La temperatura si può modificare come segue:

-  Premere il tasto "P" (figura 4).

I simboli "P" e  sono accesi. Inoltre sono accesi i 3 piccoli simboli sopra le tazze ,  e , per indicare la funzione momentanea di queste tazze, vedere „Funzione speciale“ pagina 103

-  Premere i tasti sfogliare "<" oppure ">" (figura 5) così tante volte, fino a quando si accende il simbolo .

-  Confermare con il tasto "OK" (figura 5). Il display indica la regolazione attuale. Le temperature vengono indicate come segue:

-  Temperatura bassa
-  Temperatura media
-  Temperatura alta

-  Con i tasti sfogliare selezionare eventualmente "<" oppure ">" (figura 5) una temperatura diversa.

-  Quando viene indicata la temperatura desiderata, confermarla con il tasto "OK" (figura 5). Adesso questa temperatura è programmata.

-  Per interrompere senza memorizzare, premere "P" invece di "OK".

-  Non premendo "OK", l'apparecchio ritorna dopo ca. 120 secondi automaticamente al modo d'erogazione caffè, senza memorizzare le impostazioni.

-  Per ritornare alla funzione caffè, premere conclusivamente il tasto "P" (figura 4) oppure attendere ca. 120 sec., fino a quando l'apparecchio torna automaticamente alla funzione caffè.

## 13 Pulizia e cura

Tenere l'apparecchio sempre pulito per ottenere una qualità del caffè costante e una costante efficienza.

### 13.1 Pulizia regolare

-  **Attenzione!** Prima di eseguire la pulizia, spegnere l'apparecchio. Lasciar raffreddare l'apparecchio.

-  **Attenzione!** Mai mettere l'apparecchio o singole parti di esso nella lavastoviglie. Mai immergere la macchina da caffè nell'acqua.

-  **Attenzione!** Mai versare acqua nel contenitore dei chicchi, il macinino ne verrebbe danneggiato.

-  **Attenzione!** Non utilizzare detersivi graffianti, abrasivi o corrosivi. Pulire l'involucro interno ed esterno usando unicamente un panno umido.

-  Prelevare giornalmente il serbatoio dell'acqua (figura 6) e versare via l'acqua residua. Sciacquare il serbatoio usando acqua fresca. Utilizzare giornalmente acqua fresca.

-  Vuotare giornalmente il contenitore dei fondi o, al più tardi, quando il display avverte sulla necessità di vuotarlo, „Svuotare il contenitore dei fondi“ pagina 113.

-  Togliere regolarmente la vaschetta raccogligocce. Al più tardi però quando attraverso l'apertura nella griglia raccogligocce appare il galleggiante rosso della vaschetta raccogligocce (figura 28).

-  Pulire regolarmente, minimo una volta la settimana, il serbatoio dell'acqua (N), la vaschetta raccogligocce (O), la griglia raccogligocce (A) e il contenitore dei fondi (Q) con acqua calda, un detersivo blando ed ev. con un pennello.

-  Dopo ogni schiumatura togliere l'ugello del vapore e pulirlo accuratamente dai residui di latte, vedere „Pulire l'ugello del vapore“ pagina 110.



- ☞ Controllare, che le aperture dell'erogatore del caffè non siano intasate. Si possono pulire utilizzando un ago per rimuovere i residui di caffè essiccati (figura 29).

### 13.2 Svuotare il contenitore dei fondi

L'apparecchio conta la quantità di caffè preparati. Dopo 14 tazze preparate singolarmente (oppure 7 doppie tazze), si accende il simbolo ☒, per avvertire che il contenitore dei fondi è pieno e che deve essere svuotato e pulito. Fintanto il contenitore dei fondi non sarà pulito, la macchina da caffè non può preparare caffè.

- ☞ Per pulire, sbloccare lo sportello di servizio premendo il rispettivo pulsante d'apertura e aprirlo (figura 30), si accende il simbolo ☒.
- ☞ Prelevare dopo la vaschetta raccogli-gocce (figura 31), vuotarla e pulirla.
- ☞ Vuotare e pulire accuratamente il contenitore dei fondi. Fare attenzione ad eliminare tutti i residui depositati nel contenitore.

**Importante:** Ogni volta che si estrae la vaschetta raccogli-gocce, occorre vuotare anche il contenitore dei fondi, anche se non è ancora completamente pieno. In caso contrario, quando si preparano i prossimi caffè può accadere, che il contenitore dei fondi si riempra eccessivamente e che i fondi di caffè in eccesso intasino la macchina da caffè.

- i** Dopo prelevata la vaschetta raccogli-gocce, il simbolo ☒ lampeggia.
- i** Usando l'apparecchio quotidianamente, vuotare per principio anche il contenitore quotidianamente. Vuotare il contenitore dei fondi sempre ad apparecchio acceso. Solo così l'apparecchio riconosce lo svuotamento del contenitore.

### 13.3 Pulire il macinino

I residui di caffè possono essere rimossi dal contenitore dei chicchi usando un pennello morbido o un aspirapolvere.

- !** **Attenzione!** Mai versare acqua nel macinino, quest'ultimo ne verrebbe danneggiato.
- ☞ Spegnere l'apparecchio con il tasto Ins/Dis (figura 11) e con l'interruttore principale (figura 8). Sfilare la spina dalla presa della rete elettrica.
- ☞ Togliere i restanti chicchi di caffè (utilizzando per es. aspirapolvere con tubo flessibile o un ugello per fessure).
- i** Quando non è possibile rimuovere un corpo estraneo, rivolgersi al servizio dopo vendita. **Se il macinino si blocca o viene danneggiato in seguito ad un corpo estraneo, eventualmente il danno non è coperto dalla garanzia.**

- !** **Attenzione!** Pericolo di lesioni in seguito alla rotazione del macinino. Mai accendere l'apparecchio durante i lavori al macinino. Ciò può causare ferite gravissime. Sfilare imperativamente la spina dalla presa della rete elettrica.

- ☞ Controllare adesso il funzionamento del macinino usando una piccola quantità di chicchi e preparando un caffè. Alla prima macinazione o dopo la pulizia, l'unità di bollitura verrà riempita con un quantitativo di caffè in polvere ridotto, perché dapprima deve essere riempito il canale. Ciò può influenzare la qualità del primo caffè.

### 13.4 Pulire l'unità di bollitura

Noi consigliamo di pulire regolarmente l'unità di bollitura (dipende dalla frequenza con la quale si usa la macchina). Prima di mettere fuori servizio per lungo tempo l'apparecchio (per es. durante le vacanze), occorre vuotare il contenitore dei fondi e il serbatoio dell'acqua e pulire accuratamente l'apparecchio, incl. l'unità di bollitura. Procedere come segue:

- ☞ Premendo il tasto Ins/Dis (figura 11), spegnere la macchina da caffè (non sfilare la spina dalla rete elettrica) e attendere, fino a quando si spengono tutti i simboli!

①

☞ Sbloccare lo sportello di servizio premendo il rispettivo pulsante di sbloccaggio e aprirlo (figura 30).

☞ Prelevare la vaschetta raccogliogocce e il contenitore dei fondi (figura 31) e pulirli.

☞ Premere lateralmente e verso il centro sui due tasti di sbloccaggio rossi dell'unità di bollitura (figura 32) ed estrarre l'unità di bollitura.

**i** **Attenzione:** L'unità di bollitura può essere prelevata solamente dopo che l'apparecchio sarà stato spento con il tasto **Ins/Dis** ① che si trova sul lato frontale dell'apparecchio. L'apparecchio non deve essere staccato dalla rete elettrica. Cercando di prelevare l'unità di bollitura con macchina da caffè accesa, questa potrebbe danneggiarsi seriamente.

☞ Pulire l'unità di bollitura sotto l'acqua corrente del rubinetto, senza usare detersivi. **Mai lavare l'unità di bollitura nella lavastoviglie.**

☞ Pulire accuratamente l'interno della macchina. Grattare via le incrostazioni di caffè nella macchina da caffè usando una forchetta di legno o di plastica o un oggetto simile che non graffia la superficie (figura 33), e poi aspirare via i residui con un aspirapolvere (figura 34).

☞ Per reinserire far scorrere l'unità di bollitura (figura 36, a) nel supporto (figura 36, b) e nella spina (figura 36, c). La spina dev'essere inserita nel tubo (figura 36, d) sotto l'unità di bollitura.

☞ Ora premere energicamente sulla scritta **PUSH** (figura 36, e), fino a quando l'unità di bollitura aggancia percettibilmente.

☞ Dopo aver sentito il clic dell'aggancio, accertarsi che i tasti rossi (figura 36, f) siano scattati, altrimenti non sarà possibile chiudere lo sportello di servizio.

Figura 37: Entrambi i tasti rossi sono scattati correttamente.

Figura 38: Entrambi i tasti rossi non sono scattati.

☞ Inserire nuovamente la vaschetta raccogliogocce assieme al contenitore dei fondi.

☞ Chiudere lo sportello di servizio.

**i** Se l'unità di bollitura non è inserita correttamente, cioè fino ad udire il clic dell'aggancio e i tasti rossi non sono scattati correttamente, non sarà possibile chiudere lo sportello di servizio.

**i** Quando l'unità di bollitura si lascia inserire solo con difficoltà, questa dovrà essere posizionata all'altezza corretta, cioè comprimendo fortemente l'unità di bollitura contemporaneamente dall'alto e dal basso, come mostrato nella figura 35.

**i** Se l'inserimento dell'unità di bollitura continuasse ad essere difficoltoso, chiudere lo sportello di servizio, estrarre dalla presa la spina del cavo d'alimentazione e infilarla di nuovo.







































Attendere fino a quando si spengono tutti i simboli, aprire poi lo sportello di servizio e inserire nuovamente l'unità di bollitura.

### 13.5 Eseguire il programma di decalcificazione

Il programma di decalcificazione permette una decalcificazione semplice ed efficace dell'apparecchio. Quando il simbolo luminoso  lo indica, l'apparecchio dev'essere decalcificato.

**!** **Attenzione:** Evitare assolutamente di usare un decalcificante qualsiasi, non consigliato da AEG/Electrolux. Usando decalcificanti diversi da quelli consigliati, AEG/Electrolux non si assumono garanzie per eventuali danni. I liquidi decalcificanti si ottengono presso il commercio specializzato oppure mediante la AEG/Electrolux Serviceline.

**i** Il processo di decalcificazione dura ca. 45 minuti e non dovrebbe essere interrotto. In caso di caduta della linea elettrica, il programma dovrà essere riavviato a nuovo.

-  Prima di avviare il programma di decalcificazione, pulire l'unità di bollitura (vedere „Pulire l'unità di bollitura“ pagina 113).
-  Premere il tasto "P" (figura 4).  
I simboli "P" e  sono accesi. Inoltre sono accesi i 3 piccoli simboli sopra le tazze ,  e , per indicare la funzione momentanea di queste tazze, vedere „Funzione speciale“ pagina 103
-  Premere i tasti sfogliare "<" oppure ">" (figura 5) così tante volte, fino a quando si accende il simbolo .
-  Confermare con il tasto "OK" (figura 5). I simboli  e  lampeggiano e "P" resta permanentemente acceso.
-  Per interrompere il programma di decalcificazione in questa posizione, spegnere l'apparecchio con il tasto "Ins/Dis" .
-  Vuotare il serbatoio dell'acqua, riempire con almeno 1 litro d'acqua e aggiungere il prodotto decalcificante.
-  **Attenzione:** Fare attenzione che eventuali spruzzi di decalcificante non macchino superfici sensibili agli acidi quali il marmo, la pietra arenaria e la ceramica.
-  Porre sotto l'ugello del vapore un contenitore con un volume di almeno 1,5 litri (figura 9).
-  Girare la manopola del vapore e dell'acqua bollente nella posizione .  
Il programma di decalcificazione si avvia e il liquido decalcificante esce dall'ugello del vapore. I simboli ,  e "P" sono permanentemente accesi.  
Un programma di decalcificazione esegue automaticamente tutta una serie di risciacqui e intervalli, per rimuovere i residui di calcare dall'interno della macchina da caffè.  
Dopo circa 30 minuti il serbatoio dell'acqua è vuoto e i simboli  e  lampeggiano e "P" resta permanentemente acceso.
-  Girare indietro la manopola del vapore e dell'acqua bollente fino alla posizione .  
L'apparecchio adesso è pronto per un processo di risciacquo con acqua fresca.
-  Estrarre il serbatoio dell'acqua, riempirlo con acqua fresca e inserirlo nuovamente.
-  Svuotare il contenitore sotto l'ugello del vapore e posizionarlo nuovamente sotto l'ugello.
-  Girare la manopola del vapore e dell'acqua bollente nella posizione .  
L'apparecchio esegue adesso un risciacquo con acqua fresca e l'acqua di risciacquo esce dall'ugello del vapore. I simboli ,  e "P" sono permanentemente accesi.  
Dopo alcuni minuti il serbatoio dell'acqua è vuoto e i simboli  e  lampeggiano e "P" resta permanentemente acceso.
-  Girare la manopola del vapore e dell'acqua bollente indietro nella posizione .  
I simboli conformi alla funzione del caffè selezionata per ultima vengono visualizzati, e il simbolo  resta permanentemente acceso.
-  Svuotare l'apparecchio con l'acqua di risciacquo.
-  Estrarre il serbatoio dell'acqua riempirlo con acqua fresca e inserirlo nuovamente.  
L'apparecchio è nuovamente pronto all'esercizio e nello stato della funzione caffè selezionata per ultimo.
-  Dopo il programma di decalcificazione, consigliamo di vuotare la prima tazza di caffè erogata.

## 14 Ordinazione di accessori

Affinché possa usufruire a lungo del suo apparecchio e per evitare difetti, è molto importante pulire e decalcificare regolarmente l'apparecchio. Il decalcificante originale può essere acquistato anche direttamente da noi.



In Germania rivolgersi alla nostra hotline ordinazioni:

1801 - 20 30 60\*





(\* tariffa locale dalla rete fissa di Telecom tedesco)  
da lunedì a venerdì, ore 8.00-18.00

## 15 Cosa occorre fare quando sul display appare i seguente simboli...

**Il simbolo  resta permanentemente acceso**

- Il serbatoio dell'acqua è vuoto o non è stato inserito correttamente.
-  Riempire il serbatoio dell'acqua e inserirlo attenendosi alle istruzioni, vedere „Riempire l'acqua” pagina 103.
- Il serbatoio dell'acqua è sporco o in esso si sono formate incrostazioni calcaree.
-  Sciacquare il serbatoio dell'acqua o decalcificare.

**I simboli  e  lampeggiano**



- La macchina da caffè non funziona.
-  Porre un contenitore sotto l'ugello del vapore e girare in senso antiorario la manopola del vapore e acqua bollente nella posizione   (figura 9).
- Il caffè fuoriesce troppo lentamente.
-  Girare la manopola per la regolazione del grado di macinazione (figura 12) in senso orario di una posizione, fintanto il macinino macina i chicchi di caffè durante una preparazione del caffè (vedere „Regolare il grado di macinazione” pagina 111).

**Il simbolo  resta permanentemente acceso**

- Il contenitore dei fondi è pieno.
-  Svotare, pulire e inserire di nuovo correttamente il contenitore dei fondi come descritto in „Svuotare il contenitore dei fondi” pagina 113.



**Il simbolo  lampeggia**

- Dopo la pulizia il contenitore dei fondi non è stato reinserito.
-  Aprire lo sportello di servizio e inserire il contenitore dei fondi.

**I simboli  oppure  e  lampeggiano**

- Dopo selezionata la funzione per il caffè premacinato, non è stata versato caffè in polvere nel canale di riempimento.
-  Riempire il caffè in polvere come descritto presso „Preparare il caffè con la polvere di caffè” pagina 108.

**Tutti i simboli per l'intensità del caffè      e  lampeggiano**

- Il contenitore dei chicchi di caffè è vuoto.
-  Riempire il contenitore dei chicchi di caffè, vedere „Riempire il contenitore dei chicchi di caffè” pagina 103.
- Quando il macinino fa un rumore eccessivo, può significare che una piccola pietra mischiata ai chicchi di caffè ha bloccato il macinino.
-  In tal caso rivolgersi al servizio dopo vendita. **Se il macinino si blocca o viene danneggiato in seguito ad un corpo estraneo, eventualmente il danno non è coperto dalla garanzia.**



**Il simbolo  resta permanentemente acceso**

- Indica, che la macchina da caffè è incrostata con calcare.
-  Il programma di decalcificazione descritto al capitolo „Eeguire il programma di decalcificazione” pagina 114 dev'essere eseguito prima possibile.

**Il simbolo  resta permanentemente acceso**

- Lo sportello di servizio è aperto.
-  Chiudere lo sportello di servizio. Quando non fosse possibile chiudere lo sportello di servizio, accertarsi che l'unità di bollitura sia stata inserita correttamente (vedere „Pulire l'unità di bollitura“ pagina 113).



**Il simbolo  lampeggia**

- Probabilmente è stato dimenticato di inserire l'unità di bollitura nella macchina da caffè dopo essere stata pulita.
-  Inserire l'unità di bollitura, vedere „Pulire l'unità di bollitura“ pagina 113.
- L'interno della macchina è sporco.
-  Pulire accuratamente l'interno della macchina, vedere „Pulire l'unità di bollitura“ pagina 113. Se dopo avvenuta la pulizia della macchina da caffè sul display appare ancora la comunicazione, allora si prega di rivolgersi al servizio dopo vendita.

**Il simbolo  resta permanentemente acceso**

- Ciò indica un allarme generale.
-  In tal caso si rivolga al servizio dopo vendita.

**I simboli  e  lampeggiano**

- L'apparecchio è stato acceso mentre il pulsante a manopola per vapore e acqua bollente si trovava nella posizione "aperto" .
-  Girare il pulsante a manopola per il vapore e l'acqua bollente in senso orario (figura 10) fino all'arresto sulla posizione .

**I simboli  e  lampeggiano**

- La temperatura ambiente è troppo bassa, per poter mettere in esercizio l'apparecchio.
-  Usare l'apparecchio in un locale più caldo.



**16 Problemi risolvibili, prima di chiamare il servizio dopo vendita**

Quando la macchina da caffè non funziona, è possibile trovare facilmente la causa del disturbo d'esercizio ed eliminarla, consultando il capitolo „Cosa occorre fare quando sul display appare il seguente simbolo...“ pagina 116. Se la macchina da caffè non dovesse invece visualizzare alcun simbolo, si prega di eseguire i seguenti controlli, prima di rivolgersi al servizio dopo vendita.

**Il caffè non è bollente**

- Le tazze non sono state preriscaldate.
-  Preriscaldare le tazze, sciacquandole con acqua calda o appoggiandole almeno 20 minuti sul ripiano per tazze (H) riscaldato, fintanto il macinino macina i chicchi di caffè durante la preparazione del caffè (vedere „Consigli per l'erogazione di un caffè caldo“ pagina 107).

**La cremetta sul caffè è insufficiente**

- La macinazione del caffè è troppo grezza.
-  Girare la manopola per la regolazione del grado di macinazione in senso antiorario di una posizione, fintanto il macinino macina i chicchi di caffè durante la preparazione del caffè (vedere „Regolare il grado di macinazione“ pagina 111).
- La miscela di caffè non è adatta.
-  Usare una miscela di caffè adatta per le macchine da caffè automatiche.

**Il caffè fuoriesce troppo lentamente**

- La macinazione del caffè è troppo fine.
-  Girare la manopola per la regolazione del grado di macinazione in senso orario di una posizione, fintanto il macinino macina i chicchi di caffè durante la preparazione del caffè (vedere „Regolare il grado di macinazione“ pagina 111).

①

### Il caffè fuoriesce troppo velocemente

- La macinazione del caffè è troppo grezza.
- ☞ Girare la manopola per la regolazione del grado di macinazione in senso antiorario di una posizione (vedere „Regolare il grado di macinazione“ pagina 111).

### Il caffè fuoriesce da un solo beccuccio d'erogazione del caffè

- I fori d'erogazione sono intasati.
- ☞ Il caffè essiccato può essere rimosso con uno spillo (figura 29).

### Nonostante l'uso della manopola per il vapore e l'acqua bollente, dall'ugello del vapore non fuoriesce vapore

- I forellini dell'ugello del vapore e della parte interna dell'ugello del vapore sono intasati.
- ☞ Pulire i forellini dell'ugello del vapore e della parte interna dell'ugello del vapore (vedere „Pulire l'ugello del vapore“ pagina 110).

### Quando è stata selezionata la funzione ☞ oppure ☞☞, dalla macchina non fuoriesce caffè, bensì dell'acqua

- Il caffè in polvere potrebbe essersi bloccato nel canale di riempimento.
- ☞ Togliere con un coltello il caffè in polvere che intasa il canale di riempimento (vedere „Preparare il caffè con la polvere di caffè“ pagina 108)(figura 22). Dopo pulire l'unità di bollitura e l'interno della macchina (vedere „Pulire l'unità di bollitura“ pagina 113).

### Premendo il tasto ① la macchina non si accende

- L'interruttore principale sulla parte posteriore dell'apparecchio non è stato acceso (figura 8) o la spina di collegamento alla rete non è stata innestata.
- ☞ Controllare che l'interruttore principale si trovi nella posizione "I" e che il cavo di collegamento alla rete sia infilato nella presa.

### L'unità di bollitura non si lascia estrarre per la pulizia

- La macchina da caffè è accesa. L'unità di bollitura si può estrarre solo a macchina spenta.
- ☞ Spegner l'apparecchio ed estrarre l'unità di bollitura (vedere „Pulire l'unità di bollitura“ pagina 113).

**i** **Attenzione:** L'unità di bollitura può essere prelevata solamente dopo che l'apparecchio sarà stato spento con il tasto Ins/Dis ① che si trova sul lato frontale dell'apparecchio. L'apparecchio non deve essere staccato dalla rete elettrica. Cercando di prelevare l'unità di bollitura con macchina da caffè accesa, questa potrebbe danneggiarsi seriamente.

### Il caffè non fuoriesce dagli erogatori del caffè, ma lateralmente dallo sportello di servizio

- Le aperture degli erogatori del caffè sono intasati con del caffè essiccato.
- ☞ Il caffè essiccato può essere rimosso con uno spillo (figura 29).
- Il cassetto orientabile (R) interno presso lo sportello di servizio è bloccato e non oscilla.
- ☞ Pulire accuratamente il cassetto oscillante, in particolare nelle vicinanze delle cerniere, in modo che possano restare mobili.

### È stato utilizzato caffè in polvere (invece dei chicchi di caffè) e la macchina non eroga caffè

- È stata riempita una quantità eccessiva di caffè premacinato.
- ☞ Prelevare l'unità di bollitura e pulire accuratamente l'interno della macchina come descritto presso „Pulire l'unità di bollitura“ pagina 113. Ripetere il processo, utilizzando al massimo 2 misurini rasi di caffè in polvere.
- La manopola "intensità caffè / caffè premacinato" non è stata girata nella posizione ☞ oppure ☞☞ e l'apparecchio ha utilizzato sia il caffè premaci-

nato, sia la polvere di caffè macinata dal macinino.

- ☞ Pulire accuratamente l'interno della macchina, come descritto presso „Pulire l'unità di bollitura" pagina 113. Ripetere la procedura, girando dapprima la manopola "intensità caffè / caffè pre-macinato" nella giusta posizione, come descritto presso „Preparare il caffè con la polvere di caffè" pagina 108.
- Il caffè premacinato è stato caricato a macchina spenta.
- ☞ Prelevare l'unità di bollitura e pulire accuratamente l'interno della macchina come descritto presso „Pulire l'unità di bollitura" pagina 113. Ripetere la procedura a macchina accesa.

#### Cosa fare, quando occorre trasportare l'apparecchio?

- Conservare l'imballaggio originale che serve da protezione dell'apparecchio. Per proteggerlo dai graffi, usare assolutamente il sacchetto di plastica originale.
- Proteggere dagli urti l'apparecchio e il bricco per mantenere al caldo. Non è possibile assumere responsabilità per i danni durante il trasporto
- Vuotare il serbatoio dell'acqua e il contenitore dei fondi.
- Si prega di fare attenzione anche al posto in cui si colloca l'apparecchio, soprattutto durante la stagione fredda. Potrebbero verificarsi danni da gelo.

## 17 Funzione di statistica





L'apparecchio offre la possibilità di richiedere i seguenti valori:

- la quantità di tutti i caffè preparati finora con l'apparecchio,
- la quantità dei bricchi erogati per 4 tazze, 6 tazze, 8 tazze e 10 tazze,
- la quantità delle decalcificazioni eseguite, e inoltre
- la quantità di litri d'acqua, erogati dalla macchina.







**i** Quando si erogano 2 tazze di caffè contemporaneamente, queste vengono contate anche come 2 tazze. Per attivare la funzione di statistica, l'apparecchio dev'essere spento.

☞ Se necessario, spegnere l'apparecchio con il tasto "Ins/Dis"  (figura 11).

☞ Premere il tasto "P" (figura 4) per una durata di almeno 6 secondi.

I simboli "P" e  accesi. Inoltre sono accesi i 3 piccoli simboli sopra le tazze ,  e , unper indicare la funzione momentanea di queste tazze, vedere „Funzione speciale" pagina 103.



☞ Premere i tasti sfogliare "<" oppure ">" (figura 5) così tante volte, fino a quando si accende il simbolo, per il quale si desidera visualizzare la rispettiva statistica:

-  Quantità di caffè preparati
-  Quantità di decalcificazioni eseguite
-  Quantità di bricchi da 4 tazze preparati
-  Quantità di bricchi da 6 tazze preparati
-  Quantità di bricchi da 8 tazze preparati
-  Quantità di bricchi da 10 tazze preparati
-  Quantità di litri d'acqua erogati

Quando è acceso un simbolo, l'appartente quantità può essere visualizzata come segue:

☞ Premere e mantenere premuto il tasto "OK" (figura 5).

Ora iniziano a lampeggiare susseguentemente singoli indicatori, che indicano la quantità richiesta:

-  1 lampeggio corrisponde a 1
-  1 lampeggio corrisponde a 10
-  1 lampeggio corrisponde a 100

I



1 lampeggio corrisponde a 1,000



1 lampeggio corrisponde a 10,000

I segnali lampeggianti si ripetono continuamente fino a quando resta premuto il tasto "OK". Prima di ogni ripetizione viene intercalato un intervallo di 3 secondi.

- Contare il numero dei singoli segnali lampeggianti.

Esempio: La seguente sequenza di lampeggi corrisponde al numero 1'529.

9 lampeggi

2 lampeggi

5 lampeggi

1 lampeggio

0 lampeggi

- Per abbandonare la funzione di statistica, premere il tasto "P" (figura 4) per almeno 6 secondi.

## 18 Dati tecnici

Tensione di rete: 220-240 V  
Potenza assorbita: 1350 W

L'apparecchio è conforme alle seguenti direttive CE:

- 73/23/CEE del 19.2.1973 „Direttiva sulla bassa tensione“, inclusa la direttiva modificata 93/68/CEE.
- 89/336/CEE del 3.5.1989 „direttiva EMV“, inclusa la direttiva modificata 92/31/CEE.

## 19 Smaltimento



### Materiale d'imballaggio

I materiali usati per l'imballaggio sono ecologici e riutilizzabili. Le parti in materiale sintetico sono contrassegnate, per es. >PE<, >PS< ecc. Smaltire i materiali dell'imballaggio, conformemente al loro contrassegno, negli appositi contenitori collettivi presso i punti di smaltimento comunali



### Apparecchio vecchio

Il simbolo sul prodotto o sull'imballaggio indica, che questo prodotto non deve essere trattato come un normale rifiuto domestico, bensì consegnato presso un punto di raccolta per il riciclaggio di apparecchi elettrici ed elettronici. Con il suo contributo al corretto smaltimento di questo prodotto protegge l'ambiente e la salute dei suoi simili. Uno smaltimento sbagliato è un pericolo per l'ambiente e la salute. Ulteriori informazioni sul riciclaggio di questo prodotto si ottengono presso il municipio, il servizio di nettezza urbana o il negozio, nel quale è stato acquistato il prodotto.

## 20 In caso di ricorso al servizio

Conservare in ogni caso l'imballaggio originale incluse le parti schiumate. Per evitare danni da trasporto, l'apparecchio deve essere imballato in modo ben protetto

Quando si invia l'apparecchio, allegare sempre il bricco per mantenere al caldo. Questo è necessario a fini di test dell'apparecchio.



## **E Estimada clienta, estimado cliente,**

Lea por favor atentamente estas instrucciones de uso. ¡Observe sobre todo las indicaciones sobre la seguridad! Conserve las instrucciones de uso para consultas posteriores y entréguelas también a los eventuales propietarios sucesivos del aparato.

### **Indice**

<b>1 Texto de las figuras</b>	<b>122</b>	<b>10 Preparación de agua caliente</b>	<b>132</b>
1.1 Vista frontal (figura 1)	122	<b>11 Ajustar el molinillo</b>	<b>133</b>
1.2 Vista frontal con puerta de servicio abierta (figura 2)		<b>12 Ajustar la temperatura del café</b>	<b>133</b>
1.3 Panel de mando (figura 3)	122	<b>13 Limpieza y cuidados</b>	<b>134</b>
<b>2 Café y espresso</b>	<b>123</b>	13.1 Limpieza regular	134
<b>3 Indicaciones de seguridad</b>	<b>123</b>	13.2 Vaciar el contenedor de residuos	134
<b>4 Modo Especial</b>	<b>125</b>	13.3 Limpieza del molinillo	135
<b>5 Primera puesta en marcha</b>	<b>125</b>	13.4 Limpieza de la unidad de infusiones	135
5.1 Montar el aparato y enchufarlo	125	13.5 Ejecución del programa de descalcificación	136
5.2 Añadir agua	125	<b>14 Pedido de accesorios</b>	<b>137</b>
5.3 Llenar el contenedor de granos de café	125	<b>15 Qué hacer cuando en la pantalla aparece el siguiente mensaje...</b>	<b>137</b>
5.4 Primera puesta en marcha	126	<b>16 Problemas resolubles, antes de que llame al servicio al cliente</b>	<b>139</b>
5.5 Encender el aparato	126	<b>17 Modo Estadística</b>	<b>140</b>
5.6 Apagar el aparato	127	<b>18 Datos técnicos</b>	<b>141</b>
5.7 Ajustar la dureza del agua	127	<b>19 Eliminación</b>	<b>142</b>
<b>6 Preparar café con granos</b>	<b>128</b>	<b>20 En caso de reparaciones</b>	<b>142</b>
6.1 Consejos para preparar un café caliente	129		
<b>7 Preparar varias tazas con la función jarra</b>	<b>129</b>		
<b>8 Preparar café con café molido</b>	<b>130</b>		
<b>9 Espumar la leche</b>	<b>131</b>		
9.1 Limpiar la tobera de vapor	132		

E

## 1 Texto de las figuras















### 1.1 Vista frontal (figura 1)

- A Rejilla de goteo
- B Jarra térmica
- C Interruptor principal (parte posterior del aparato)
- D Salida del café de altura regulable
- E Panel de mando (ver figura 3)
- F Tapa para contenedor de café en grano
- F Tapa para compartimento de café molido
- H Bandeja calentatazas
- J Tubo giratorio para vapor y aguacaliente
- K Tobera de vapor (extraíble)
- L Parte interior de tobera de vapor (extraíble)
- M Mando de apertura para puerta de servicio
- N Depósito de agua con marca de nivel máximo (extraíble)
- O Bandeja recoge gotas con flotador (extraíble)

### 1.2 Vista frontal con puerta de servicio abierta (figura 2)

- P Puerta de servicio (abierta)
- Q Contenedor de residuos (desmontable)
- R Compartimento basculante
- S Unidad de infusiones
- T Mando para configurar el grado de molienda
- U Contenedor de granos de café
- V Cuchara de medida
- W Compartimento para café premolido
- X Placa de características (parte inferior del aparato)
- Y Descalcificador líquido
- Z Cinta de prueba

### 1.3 Panel de mando (figura 3)

- a Mando giratorio "Gusto del café / café premolido"
- b Mando giratorio "Tamaño de las tazas"
- c Pantalla
- d Tecla "1 taza de café" 
  - En el Modo Especial, esta tecla sirve para "Pasar" ("<")
- e Tecla "2 tazas de café" 
  - En el Modo Especial, esta tecla sirve para "Pasar" (">")
- f Tecla "Vapor" 
  - En el Modo Especial, esta tecla confirma el punto actual del menú ("OK")
- g Tecla "MENÚ"
  - En el Modo Especial, con esta tecla se vuelve al nivel anterior, sin modificaciones ("P")
- h Tecla "Encendido/Apagado" 
- j Mando giratorio para vapor y agua caliente
- k Tecla "Función gusto jarra" 
  - l Símbolo "Café premolido"
  - m Símbolo "Jarra"
  - n Símbolo "Café cargado-flojo"
  - o Símbolo "Tamaño tazas"
  - p Símbolo "Depósito de agua vacío" 
  - q Símbolo "Descalcificar" 
  - r Símbolo "Temperatura del aparato" 
  - s Símbolo "Compuerta de servicio abierta" 
  - t Símbolo "Depósito de restos de café" 
  - u Símbolo "Atención" 
  - v Símbolo "Agua caliente" 
  - w Símbolo "Vapor" 
  - x Símbolo "Preparación 2 tazas" 
  - y Símbolo "Preparación 1 taza" 
  - z Símbolo para el Modo Especial

## 2 Café y espresso

El funcionamiento de su máquina automática le garantiza el más sencillo **manejo**, en la preparación de café y en su mantenimiento y cuidados.

Si prefiere un **sabor** particular concreto, éste se consigue mediante

- el sistema de prehervido: antes del verdadero proceso de hervido, se humedece el polvo de café para extraer todo el aroma,
- la cantidad de agua por taza regulable individualmente entre espresso y café "largo" con crema,
- la temperatura del café regulable individualmente con la que se hervirá el café,
- la posibilidad de elegir entre una taza de café normal o fuerte,
- el grado de molienda regulable según el tueste de los granos,
- y por último y tan importante como lo anterior, mediante la crema, esa corona de espuma que consigue que un espresso resulte incomparable para los gourmets.

**Por cierto:** El tiempo de contacto del agua con el polvo de café es mucho más corto en un espresso que en el caso de un café de filtro convencional. ¡Se consigue así que se disuelvan menos sustancias amargas del polvo del café por lo que el espresso resulta mucho más digerible!

## 3 Indicaciones de seguridad



La seguridad de este aparato es conforme a las normas reconocidas de la técnica y a la ley de seguridad de los aparatos. Sin embargo, como fabricantes, deseamos que se familiaricen con las siguientes indicaciones de seguridad.

### Seguridad general

- ¡El aparato sólo puede conectarse a una red eléctrica que se corresponda con la tensión, tipo de corriente y frecuencia que se indican en la placa de características (ver parte inferior del aparato)!
- Nunca se deberá poner en contacto el cable de alimentación con las partes calientes del aparato.
- ¡No tire nunca del cable para desenchufar el enchufe de la red!
- No deberá ponerse en marcha el aparato si:
  - el cable de alimentación está dañado o
  - la carcasa muestra daños visibles.
- Enchufe el aparato sólo si el aparato está apagado.
- Este aparato no está concebido para que sea utilizado ni manejado por personas (incluidos niños) que por razones de su inexperiencia o falta de conocimiento, no estén capacitados para manejarlo de forma segura, ni por personas (incluidos niños) con sus capacidades físicas, sensoriales y psíquicas limitadas, a no ser que fueran instruidos por una persona responsable sobre cómo usar el aparato de forma segura y fueran supervisados inicialmente por dicho responsable.

### Seguridad para niños

- ¡No deje el aparato en funcionamiento sin supervisión y preste una especial atención en presencia de niños!
- No debe permitirse que los niños tengan acceso al material de embalaje, como, por ejemplo, a las bolsas de plástico.

E

### Seguridad durante su funcionamiento

- ¡Atención! La salida de café, la tobera de vapor y la bandeja de tazas se calientan durante el funcionamiento. ¡Mantenga alejados a los niños!
- ¡Atención! ¡Peligro de escaldaduras si la tobera de vapor está activada! El agua caliente que sale y/o el chorro de vapor caliente pueden ocasionar escaldaduras. Active la tobera de vapor sólo si sujeta un recipiente debajo de la tobera.
- ¡No caliente con vapor ningún líquido inflamable!
- ¡Utilice el aparato sólo si hay agua en el sistema! Rellene el depósito de agua sólo con agua fría, nada de agua caliente, leche u otros líquidos. Tenga en cuenta el nivel máximo de llenado de unos 1,8 litros.
- ¡No introduzca granos de café congelados o caramelizados en el contenedor de granos de café, introduzca únicamente granos de café tostados! Quite los cuerpos extraños del café en grano, p.ej. pequeñas piedras. La garantía puede no tener validez si el molinillo se bloquea o se daña por efecto de un cuerpo extraño.
- Introduzca sólo café molido en la entrada de café en polvo.
- No deje el aparato encendido si no es necesario.
- No exponga el aparato a las influencias climáticas.
- Si utiliza un alargador de cable, emplee únicamente un cable convencional con una sección de al menos 1,5 mm<sup>2</sup>.
- Aquellas personas con deficiencias motrices, no deberían nunca utilizar el aparato sin una persona supervisando para evitar peligros.
- ¡Utilice el aparato sólo si están colocados la bandeja recoge gotas, el contenedor de residuos y la rejilla de goteo!

### Seguridad durante la limpieza y cuidados

- Cumpla las indicaciones de limpieza y descalcificación.
- ¡Apague y desenchufe el aparato antes de limpiarlo o de llevar a cabo un mantenimiento!
- No sumerja el aparato en agua.
- ¡Limpie la tobera de vapor sólo si está desconectada, fría y sin presión!
- No lave los componentes del aparato en el lavavajillas.
- **Nunca introduzca agua en el molinillo, porque lo dañaría.**

No abra ni repare el aparato. Como consecuencia de reparaciones incorrectas, pueden generarse peligros considerables para el usuario.



Únicamente el personal experto podrá llevar a cabo reparaciones en los aparatos eléctricos.



En caso de que fuera necesaria una reparación, incluida la sustitución del cable de alimentación, diríjase, por favor,

- al establecimiento en el que adquirió el aparato, o
- a la línea de servicio AEG/Electrolux.

**Si el aparato se usa inadecuadamente o para otro fin distinto al suyo propio, el fabricante no se hará cargo de eventuales daños ni la garantía será efectiva; tampoco si el programa de descalcificación no se ejecuta, siguiendo estas instrucciones de uso, de forma inmediata tras la aparición del símbolo . La garantía puede no tener validez si el molinillo se bloquea o se daña por efecto de un cuerpo extraño**

## 4 Modo Especial

Pulsando la tecla "P" (fig. 4) se pasa al Modo Especial, para ajustar el grado de dureza del agua („Ajustar la dureza del agua" página 127), la temperatura del café („Ajustar la temperatura del café" página 133), ejecutar el programa de descalcificación („Ejecución del programa de descalcificación" página 136) y revisar las estadísticas („Modo Estadística" página 140). En el Modo Especial, las teclas "1 taza de café" , "2 tazas de café" , "Vapor"  y "P" sirven para navegar por los menús. La función correspondiente aparece indicada en la pantalla a través de la tecla (fig. 5):

- «<» ("1 taza de café" ) y «>» ("2 tazas de café" ) permiten "desplazarse"
- «OK» ("Vapor" ) confirma un punto
- «P» („P") vuelve al nivel anterior sin efectuar cambios

## 5 Primera puesta en marcha

### 5.1 Montar el aparato y enchufarlo

Seleccione una base adecuada, horizontal, estable, fría, seca y resistente al agua.

- ⚠ Asegúrese de que hay una buena circulación del aire. En los lados y en la parte posterior del aparato debe haber un espacio libre mínimo de 5 cm, y por encima del aparato un mínimo de 20 cm.

El aparato no debe colocarse en habitaciones cuya temperatura pueda ser de 0° C o menos (se produciría un daño al aparato por congelación del agua).

- ⚠ ¡Atención! Si el aparato se cambia de emplazamiento de una habitación fría a una caliente, ¡deberá esperar unas 2 horas antes de encenderlo!

Le recomendamos una base adecuada sobre la que colocar el aparato para evitar daños por salpicaduras.

- ✋ Enchufe el aparato únicamente a un enchufe con toma de tierra. No utilice enchufes sin toma de tierra.

### 5.2 Añadir agua

Antes de encender el aparato, asegúrese de que hay agua en el depósito de agua y, si no la hubiera, rellénelo. Con cada encendido y apagado, el aparato necesita agua para el proceso de aclarado automático.

- ✋ Extraiga el depósito de agua del aparato (fig. 6). Gire la tobera de vapor siempre hacia el centro del aparato antes de extraer el depósito de agua, de otro modo no podrá sacar el depósito.

- ✋ Rellene el depósito de agua con agua fría y fresca. Nunca llene el depósito por encima de la marca MAX.

- i** Introduzca únicamente agua fría en el depósito de agua. Nunca introduzca otros líquidos como agua mineral o leche.

- ✋ Coloque de nuevo el depósito de agua (fig. 6). Presione el depósito firmemente para que se abra la válvula del depósito de agua.

- i** Para obtener un café aromático deberá:

- cambiar el agua del depósito diariamente,
- limpiar el depósito de agua al menos una vez por semana en agua de limpieza normal (no lo meta en el lavavajillas). Aclárelo después con agua dulce y fresca.

### 5.3 Llenar el contenedor de granos de café

- ✋ Abra la tapa del contenedor de granos de café y llénelo con granos de café frescos (fig. 7). Cierre de nuevo la tapa.

- ⚠ ¡Atención! No introducir granos de café congelados o caramelizados en el recipiente para café en grano, sino sólo granos normales de café. Asegúrese de que no hay cuerpos extraños, como p.ej. piedritas, en el recipiente de los

E

granos de café. La garantía puede no tener validez si el molinillo se bloquea o se daña por efecto de un cuerpo extraño.

**i** El molinillo viene configurado de fábrica en un grado de molienda medio. Si fuera necesario, puede modificar este ajuste. Las instrucciones para modificar el grado de molienda se hallan en „Ajustar el molinillo“ página 133.

**!** El grado de molienda sólo puede modificarse durante el proceso de molienda. Si se realizan ajustes con el molinillo parado, éstos podrían dañar la máquina de café.

**i** La máquina de café viene probada de fábrica. Para ello se emplea café, por lo que es perfectamente normal que encuentre algo de café en el molinillo. En todo caso, garantizamos que la máquina de café es nueva.

#### 5.4 Primera puesta en marcha

Cuando ponga en marcha el aparato por primera vez, se deberá purgar el aire de la cafetera.

**☞** Encienda el aparato con el interruptor principal de la parte trasera (fig. 8).

Cuando se conecta el interruptor principal por primera vez, todos los símbolos del display se iluminan un par de segundos para realizar un autotest, y después parpadean los símbolos ☞ y △.

**☞** Para llenar el depósito, consulte „Añadir agua“ página 125.

**☞** Coloque de nuevo el depósito de agua (fig. 6). Presione el depósito firmemente para que se abra la válvula del depósito de agua.

**☞** Gire la tobera de vapor hacia fuera y coloque debajo una taza (fig. 9).

**☞** Gire el mando giratorio para vapor y agua caliente todo lo posible en el sentido contrario a las agujas del reloj hasta la posición ☞☞ (fig. 10).

Algo de agua sale de la tobera de vapor. Los símbolos ☞☞ y △ permanecen encendidos.

Cuando la taza está llena con aprox. 30 ml de agua, los símbolos ☞☞ y △ comienzan a parpadear.

**☞** Gire el mando giratorio para vapor y agua caliente todo lo posible en el sentido de las agujas del reloj hasta la posición ● (fig. 10) para detener el flujo el agua.

El símbolo ☞ parpadea algunos segundos y el aparato se desconecta.

**☞** Llene el contenedor de granos de café con granos de café, consulte „Llenar el contenedor de granos de café“ página 125.

#### 5.5 Encender el aparato

Antes de encender el aparato, asegúrese de que hay agua en el depósito de agua y, si no la hubiera, rellénelo. Con cada encendido y apagado, el aparato necesita agua para el proceso de aclarado automático.

**☞** Encienda el aparato con la tecla de “Encendido/Apagado” ○ (fig. 11).

**i** Inmediatamente después del encendido, el aparato se regula. Los ruidos que se oyen durante este proceso, son totalmente normales.

**i** El símbolo ☞ parpadea durante el proceso de calentamiento (aprox. 120 segundos).

Durante el calentamiento, el aparato lleva a cabo un enjuagado automático (un poco de agua sale de la salida de café y cae a la bandeja de recogida).

Una vez terminado el calentamiento, el mencionado símbolo ☞ permanece encendido.

Ahora, el aparato está listo para su uso. Se iluminarán los símbolos correspondientes al último modo de café utilizado.

## 5.6 Apagar el aparato

➔ Apague el aparato con la tecla de "Encendido/Apagado" (fig. 11). El símbolo  parpadea. El aparato llegará a cabo un aclarado y se desconectará.

**i** Si el aparato no se usa durante un tiempo prolongado, se apagará automáticamente tras 3 horas para ahorrar energía.

**i** Si no va a utilizar el aparato durante un largo periodo, después de apagarlo con la tecla de "Encendido/Apagado" debería también desconectar el interruptor principal de la parte trasera del aparato (fig. 8).

## 5.7 Ajustar la dureza del agua

Tras la primera puesta en marcha o si utiliza otra calidad de agua deberá ajustar el aparato en el nivel de dureza que se corresponda con la dureza del agua local. Utilice el bastoncito incluido en el suministro para determinar el nivel de dureza, o pregunte al consorcio de aguas cuál es su nivel de dureza.

### Determinación del nivel de dureza del agua

➔ Sumerja para ello el bastoncito durante aprox. 1 segundo en agua fría. Sacuda el agua excedente y determine el nivel de dureza según las casillas teñidas de rosa.

 **Ninguna o una casilla rosa:**  
**Nivel de dureza 1, blanda**  
hasta 1,24 mmol/l, y/o  
hasta 7° de dureza alemana, y/o  
hasta 12,6° de dureza francesa

 **Dos casillas rosas:**  
**Nivel de dureza 2, media**  
hasta 2,5 mmol/l, y/o  
hasta 14° de dureza alemana, y/o  
hasta 25,2° de dureza francesa





 **Tres casillas rosas:**  
**Nivel de dureza 3, dura**  
hasta 3,7 mmol/l, y/o  
hasta 21° de dureza alemana, y/o  
hasta 37,8° de dureza francesa

 **Cuatro casillas rosas:**  
**Nivel de dureza 4, muy dura**  
por encima de 3,7 mmol/l, y/o  
por encima de 21° de dureza alemana, y/o  
por encima de 37,8° de dureza francesa

### Ajuste y memoria del nivel de dureza determinado

Puede configurar 4 niveles de dureza. El aparato viene configurado de fábrica en el nivel de dureza 4.

➔ Pulse la tecla "P" (fig. 4) con el aparato encendido.

Se iluminan los símbolos "P" y  leuchten. Además, para indicar la función momentánea de esas teclas, se iluminan los 3 pequeños símbolos sobre las teclas ,  y  (ver „Modo Especial" página 125).

➔ Confirme la selección con la tecla "OK" (fig. 5).

El display mostrará la configuración actual. Los grados de dureza se indican como sigue:

 Grado de dureza 1

 Grado de dureza 2

 Grado de dureza 3

 Grado de dureza 4

➔ A continuación, pulse las teclas para desplazarse "<" o ">" (fig. 5) hasta que aparezca el nivel de dureza correspondiente.

➔ Confirme su selección con la tecla "OK" (fig. 5). Este grado de dureza está ahora almacenado.

**i** Para cancelar sin almacenar el valor, pulsar "P" en lugar de "OK".

Si aprox. tras 120 segundos no pulsa "OK", el aparato volverá automáticamente al modo de café anterior sin memorizar las modificaciones.

➔ Para volver al modo de café, pulse, a continuación la tecla "P" (fig. 4) o espere unos 120 seg., hasta que el aparato vuelva automáticamente al modo de café.

E

## 6 Preparar café con granos

Para la preparación de café en grano, el proceso siguiente tiene lugar **de forma totalmente automática**: Moler, hacer porciones, presionar, prehevir, hervir y expulsar la pasta de café hervida.





Gracias a la posibilidad de ajustar el grado de molienda y la cantidad de molienda, puede configurar el aparato según sus gustos personales.

-  No introducir granos de café congelados o caramelizados en el recipiente para café en grano, sino sólo granos normales de café. Asegúrese de que no hay cuerpos extraños, como p.ej. piedritas, en el recipiente de los granos de café. **La garantía puede no tener validez si el molinillo se bloquea o se daña por efecto de un cuerpo extraño.**

Seleccione, según su gusto, un espresso "corto" o un café "largo" con crema.

-  Seleccione el tamaño de tazas deseado con el mando giratorio "tamaño de tazas" (fig. 12). Se indicará el tamaño de tazas seleccionado.





-  Los tamaños de taza se indican como sigue:

	Taza de espresso
	Taza pequeña
	Taza mediana
	Taza grande
	Tazón



Puede seleccionar su café con gusto extra-suave, suave, normal, fuerte o extra-fuerte.



-  Seleccione la intensidad de café deseada con el mando giratorio "Gusto de café" (fig 13). Aparecerá el gusto seleccionado.



-  El grado de carga del café se indica como sigue:



	extra suave
	suave
	normal
	fuerte
	extra fuerte



-  Coloque una o dos tazas debajo de la salida de café (fig. 14). Subiendo o bajando la salida del café puede adaptarla la altura de la taza para reducir la pérdida de calor y las salpicaduras (fig. 15).



-  Pulse la tecla "1 taza de café"  para preparar una taza, o la tecla "2 tazas"  para 2 tazas.

Se ilumina el símbolo "1 taza"  o "2 tazas" . Ahora el aparato molerá los granos. Durante la preparación del café, el café en polvo se prehevirá mojándolo con una pequeña cantidad de agua. Tras una breve interrupción, tendrá lugar el verdadero proceso de hervido. El café cae en la taza.

Cuando ha salido la cantidad deseada de café, el aparato finaliza automáticamente el servicio y arroja el café molido usado al depósito de restos de café. Durante esta fase, el símbolo "1 taza"  o "2 tazas"  se ilumina.

-  Puede finalizar la salida de café antes de tiempo, pulsando la tecla "1 taza"  o "2 tazas"  de nuevo por poco tiempo, o girando el mando giratorio "Tamaño de tazas" (fig. 12) en el sentido contrario a las agujas del reloj en dirección a "taza espresso".

-  Una vez terminada la salida de café, podrá aumentar la cantidad de café manteniendo pulsada la tecla "1 taza"  o "2 tazas" , hasta que se alcance la cantidad deseada de café, o bien podrá girar el mando giratorio "Tamaño de las tazas" (fig. 12) en sentido horario, hacia "Tazón" (tiene que hacerlo inmediatamente tras salir todo el café, y antes de que el café molido usado caiga al depósito de restos de café).

Tras algunos segundos, una vez apagado el símbolo "1 taza"  o "2 tazas" , el aparato está otra vez listo para usarse, y usted podrá preparar el siguiente café.

-  Si sólo salen gotas o nada de café, o bien sale demasiado deprisa y la crema no resulta según su gusto, deberá



modificar el ajuste del grado de molienda, consulte para ello „Ajustar el molinillo" página 133

- i** Si parpadean los símbolos ☰ y △, el café se muele demasiado fino, y usted deberá modificar el ajuste del grado de molienda (ver „Ajustar el molinillo" página 133).
- i** Si se ilumina el símbolo ☰, deberá llenar el depósito de agua porque si no, no podrá preparar ningún café. (Es normal que quede algo de agua en el depósito mientras aparece el mensaje.)
- i** Si se ilumina el símbolo ☒, el contenedor de residuos está lleno y tiene que limpiarse, consulte „Vaciar el contenedor de residuos" página 134. Mientras no se vacíe este depósito, el símbolo permanecerá encendido, y la cafetera no podrá preparar café.
- i** No extraiga nunca el depósito de agua mientras está saliendo el café. Si se extrajera, la máquina no podría preparar ningún café más. Para expulsar el aire de la máquina de café, gire el mando giratorio para vapor y agua caliente todo lo posible en el sentido contrario a las agujas del reloj hasta la posición ☰☰, y deje que salga agua de la tobera de vapor durante unos segundos.
- i** En la primera puesta en servicio de la máquina deberá preparar al menos 4-5 cafés antes de que la máquina le ofrezca un resultado satisfactorio.



### 6.1 Consejos para preparar un café caliente:

- Si inmediatamente después de haber conectado la máquina, desea preparar la cantidad de café para una taza pequeña (menos de 60 ml), utilice el agua caliente del proceso de aclarado para calentar las tazas.
- Ajuste una temperatura de café superior, consulte „Ajustar la temperatura del café" página 133.





- No utilice tazas gruesas, salvo que estén precalentadas, porque absorben demasiado calor.
- Utilice tazas precalentadas aclarándolas con agua caliente o colocándolas durante al menos 20 minutos sobre la bandeja calentatazas (H) de la máquina de café encendida.

## 7 Preparar varias tazas con la función jarra

Con esta función podrá preparar de forma totalmente automática **varias tazas de café directamente en la jarra térmica de acero inoxidable que se entrega con el suministro: Moler, hacer porciones, presionar, prehever, hervir y expulsar el café hervido como se describe en el párrafo anterior.**

-  Gire la tapa de la jarra térmica de acero inoxidable hacia la posición de extracción (fig. 16) y retírela. Aclare la jarra y la tapa.
-  Coloque la tapa sobre la jarra térmica en la posición para vaciado (fig. 17) y coloque la jarra debajo de la salida de café (D). La salida de café debe estar desplazada completamente hacia arriba para que quepa la jarra térmica. Se iluminará uno de los símbolos de la función "Jarra", según cuántas tazas se hayan seleccionado durante la última utilización de la función "Jarra". Además se iluminan los símbolos Pasar "<" y ">".

El número de tazas que se servirán en la jarra se indica como sigue:

-  4 tazas
-  6 tazas
-  8 tazas
-  10 tazas

-  Cerciórese de que el depósito del agua está lleno, de que hay suficiente café en grano en el depósito del café y de que el depósito de restos de café está vacío, para poder preparar una serie de varios cafés en la jarra.

E

**i** Si desea modificar el grado de carga del café y la cantidad del mismo para la función "Jarra", utilice el mando giratorio "Tamaño de taza" (fig. 12) o el mando giratorio "Café cargado-flojo" (fig. 13) tal como se describe en el apartado „Preparar café con granos“ página 128.

**☞** En su caso, seleccione el símbolo correspondiente al número de tazas que quiera preparar en la jarra, con las teclas Pasar "<" o ">", por ejemplo  para 8 tazas.



**☞** Pulse la tecla "Jarra"  (fig. 19). Durante la preparación del café, el símbolo Jarra parpadea para el número seleccionado de tazas.

Una vez terminada la erogación, todos los símbolos Jarra parpadean alternadamente, y el símbolo del número seleccionado de tazas se ilumina durante el doble de tiempo que los demás símbolos.

**☞** Extraiga, a continuación, la jarra térmica y cierre la tapa (fig. 19) para mantener el café caliente durante un largo tiempo.

El aparato vuelve automáticamente al Modo Café.





**i** Si no hubiera suficiente café en grano o agua en el correspondiente depósito como para terminar la función seleccionada, o bien si el depósito de restos de café estuviera lleno, el aparato corta el proceso y se interrumpe el programa en curso. Una vez solucionado el fallo, el programa deberá iniciarse de nuevo. Para ello deberá tenerse en cuenta la cantidad de café que ya se halla en la jarra para que no se llene demasiado y se derrame.

**i** Si parpadean los símbolos  y , el café se muele demasiado fino, y usted deberá modificar el ajuste del grado de molienda (ver „Ajustar el molinillo“ página 133).



## 8 Preparar café con café molido

Con esta función puede hervir café ya molido, por ejemplo **café descafeinado**.

**!** ¡Atención! Asegúrese de que no ha quedado nada de café molido en el compartimento, y de que tampoco hay ningún cuerpo extraño en el mismo. El compartimento para café molido no es un depósito de almacenamiento, el polvo debe llegar directamente a la unidad de infusiones.

**☞** Gire el mando giratorio "Gusto del café / café premolido" (fig. 20) a la posición deseada  (para 1 taza) o  (para 2 tazas), para seleccionar la función para café premolido. Así pondrá el molinillo fuera de servicio. Se iluminará el símbolo  (para 1 taza) o ambos símbolos  (para 2 tazas).















**☞** Abra la tapa del compartimento del café en polvo y rellénelo con café en polvo fresco (fig. 21).

Utilice únicamente la cuchara de medida suministrada. Nunca ponga más de 2 medidas justas de café, de lo contrario el aparato no preparará el café, el polvo de café se esparcerá por todo el aparato, ensuciándolo, o bien el café irá saliendo gota a gota mientras parpadean los símbolos  y .

No rellene más café en polvo durante el proceso de hervido. Hágalo cuando haya finalizado el proceso completo de hervido, entonces el aparato estará listo para que pueda rellenarlo con café en polvo para la próxima taza. Nunca rellene la máquina con café en polvo si está desconectada porque podría dañarse por el interior del aparato.















**!** No utilice nunca café en polvo para máquinas de espresso totalmente automáticas. No introduzca en el compartimento para café molido granos de café, ni productos instantáneos solubles en agua o liofilizados, ni otros pol-

vos para bebidas. Un polvo demasiado fino puede producir obstrucciones.

-  Si el compartimento de café molido está obturado (por la humedad del aparato o porque ha llenado más de 2 cucharadas de medida de café en polvo), utilice ningún cuchillo o el mango de una cuchara para empujar el polvo hacia abajo (fig. 22). Extraiga la unidad de infusiones y límpiela junto con la máquina de café como se describe en „Limpieza de la unidad de infusiones“ página 135".
-  Cierre de nuevo la tapa.
-  Seleccione el tamaño de taza deseado con el mando giratorio "Tamaño de taza" (fig. 12) como se describe en el apartado „Preparar café con granos“ página 128.
-  Pulse la tecla "1 taza de café"  para preparar una taza, o la tecla "2 tazas"  para 2 tazas. Se preparará el café.
-  Si se ha seleccionado la función de café premolido en polvo para 1 taza, y no se ha puesto café molido en la tolva, al pulsar la tecla , parpadean los símbolos  y . Si se ha seleccionado la función de café premolido en polvo para 2 tazas, y no se ha puesto café molido en la tolva, al pulsar la tecla , parpadean los símbolos   y .
-  Para volver al modo de café en grano una vez preparado el café, gire el mando giratorio "Gusto del café / café premolido" (fig. 20) en la configuración de gusto de café que desee (ahora puede moler café de nuevo).

## 9 Espumar la leche

El vapor puede utilizarse para espumar la leche y para calentar líquidos. Puesto que para generar vapor se necesita una temperatura más elevada que en la preparación de café, el aparato dispone de un modo de vapor adicional.

-  Para una porción de capuccino, llene una taza grande con 1/2 a 2/3 de espresso y añada a continuación la leche espumada.
-  ¡Atención! ¡Peligro de escaldaduras si la tobera de vapor está activada! El agua caliente que sale o bien el chorro de vapor caliente pueden ocasionar quemaduras. No active por ello la tobera de vapor hasta que esté sumergida en la leche.
-  Para generar vapor, pulse la tecla "Vapor"  (fig. 23). Se ilumina el símbolo  y el aparato comienza el calentamiento. Durante este proceso parpadea el símbolo . Tras finalizar el proceso de calentamiento se ilumina el símbolo  de forma permanente. El aparato está preparado para espumar la leche.
-  Si la función de vapor no se utiliza durante más de 2 minutos, el aparato volverá automáticamente al modo de café.
-  Para evitar que se mezclen restos de agua con la leche durante el espumado, deberá en primer lugar eliminar el agua soplando. Mantenga para ello un recipiente bajo la tobera de vapor y gire el mando giratorio para vapor y agua caliente (fig. 10) a la posición  hasta que salga vapor. Gire de nuevo el mando giratorio a la posición .
-  Meta leche desnatada y fría en un tazón que se ajuste a la tobera de vapor del aparato.
-  La leche deberá estar bien fría. También es mejor que utilice un recipiente frío, mucho mejor si es de acero inoxidable y que no lo aclare antes con agua caliente.
-  Gire la tobera de vapor hacia fuera y sujete el tazón bajo la tobera de vapor de modo que la boca de la tobera penetre de manera uniforme en la leche (fig. 24).

E



**¡Atención!** Peligro de suciedad por restos de leche seca en la tobera de vapor. Asegúrese de que la tobera de vapor no esté tan sumergida en la leche que la boca de aspiración de aire situada en la parte superior de la tobera de vapor quede cubierta por la leche. Esto podría hacer que la tobera aspire leche, lo que podría ocasionar suciedad en la tobera de vapor.



Gire el mando giratorio para vapor y agua caliente (fig. 10) a la pos. . Se procede al espumado de la leche.



Para conseguir una espuma de leche cremosa, deberá mover despacio el recipiente de abajo hacia arriba. Espume la leche como mínimo hasta el doble de su volumen.



Se recomienda no dejar salir vapor durante más de 2 minutos sin interrupción.



Para finalizar el espumado, gire el mando giratorio para vapor y agua caliente (fig. 10) a la pos. ● y retire, a continuación el recipiente.



**¡Atención!** ¡Peligro de quemaduras por salpicaduras de leche caliente! Desconecte el vapor antes de que retire el recipiente con la leche espumada.



Salga del modo vapor, pulsando la tecla "Vapor" (fig. 23) o espere unos 120 seg., hasta que el aparato vuelva automáticamente al modo café.

El aparato está listo de nuevo para preparar café.



Una vez finalizado el espumado de la leche, deje que salga brevemente algo de agua caliente de la tobera, girando el mando giratorio para vapor y agua caliente (fig. 10) a la posición .

Esto es necesario para que no se sequen los restos de leche en el interior de la tobera, que podrían obturar la tobera. Utilice para ello un recipiente colector adecuado. Durante este proceso, el símbolo  se iluminará.



Coloque después el mando giratorio para vapor y agua caliente de nuevo a la Pos. ●, en la pantalla aparecerá la última configuración seleccionada para café.

## 9.1 Limpiar la tobera de vapor

**Importante:** Por razones higiénicas, se recomienda realizar el siguiente proceso después de haber espumado leche. Así evitará que se deposite leche en el interior de la tobera de vapor.



Gire el mando giratorio para vapor y agua caliente en el sentido de las agujas del reloj hasta el tope hacia la posición ●. Espere unos minutos hasta que se enfríe la tobera de vapor.



Sujete, a continuación el tubo giratorio por la empuñadura negra y abra el cierre de bayoneta de la tobera de vapor girando ligeramente en el sentido de las agujas de reloj. Tire hacia abajo la tobera de vapor (fig. 25).



Tire del tubo giratorio hacia abajo la parte interna de la tobera de vapor.



Limpie la tobera de vapor y la parte interna con agua templada.



Compruebe que ninguno de los agujeros marcados en la fig. 26 está obturado. Si lo estuvieran, introduzca una aguja y límpielos.



Monte de nuevo la parte interna empujándola cuidadosamente en el tubo giratorio.



Monte la tobera de vapor de nuevo empujándola de nuevo y girándola en el sentido contrario a las agujas del reloj.

## 10 Preparación de agua caliente



El agua caliente puede utilizarse para precalentar tazas y para preparar bebidas calientes, como té o sopas preparadas.





**¡Atención!** ¡Peligro de quemaduras si la tobera de agua caliente está funcionando! El agua caliente que sale puede

ocasionar quemaduras. Active la tobera de agua caliente sólo si hay un recipiente debajo de la tobera de agua caliente.

 Coloque un recipiente debajo de la tobera de agua caliente.

 Gire el mando giratorio para vapor y agua caliente a la posición  (fig. 10). Saldrá agua caliente, se enciende el símbolo .

 Se recomienda no dejar salir agua caliente durante más de 2 minutos sin interrupción.



 Una vez finalizado el proceso, gire de nuevo el mando giratorio para vapor y agua caliente a la posición  (fig. 10) y retire el recipiente.

## 11 Ajustar el molinillo

El molinillo viene configurado de fábrica en un grado de molienda medio. Si la salida de café fuera o bien demasiado rápida o demasiado lenta (goteo), puede modificar el grado de molienda durante el proceso de molienda.

 El grado de molienda sólo se puede modificar durante el propio proceso de molienda, es decir, el mando para el ajuste del grado de molienda (fig. 2, T, y fig. 27) sólo se puede girar mientras que el molinillo esté funcionando y moliendo café en grano al preparar el café. Si se realizan ajustes con el molinillo parado, éstos podrían dañar la máquina de café.

 Ajuste el grado de molienda con el mando para el ajuste del molinillo (fig. 2, T) (fig. 27).

- Si el café no acaba de salir o sale gota a gota (posiblemente parpadeen los símbolos  y ) , el mando deberá girarse una posición en sentido horario.

Vaya girando una posición cada vez, hasta que esté satisfecho con la salida de café configurada.

- En caso de que el café salga demasiado deprisa y la crema no esté a su gusto, gire el mando una posición en el sentido contrario a las agujas del reloj.

 Asegúrese de no girar demasiado el mando para la regulación del molinillo, porque si no, en caso de que quisiera obtener 2 cafés, el café podría salir goteando.

 El efecto de estas correcciones, las notará sin embargo, como mínimo tras 2 preparaciones seguidas de café.





### Eliminar los cuerpos extraños del molinillo



Los cuerpos extraños en el molinillo, como piedritas, podrían dañar el molinillo. Un cuerpo extraño en el café produce un ruidoso traqueteo uniforme. Si oyerá este ruido durante el proceso de molienda, desconecte el aparato inmediatamente y dirijase al servicio al cliente. **La garantía puede no tener validez si el molinillo se bloquea o se daña por efecto de un cuerpo extraño.**

## 12 Ajustar la temperatura del café

Puede elegir entre tres niveles de temperatura. El ajuste de fábrica es «Temperatura alta». Puede modificarlo de la siguiente manera:

 Pulse la tecla "P" (fig. 4).



Se iluminan los símbolos "P" y . Además se iluminan los 3 pequeños símbolos sobre las teclas ,  y , para indicar la función momentánea de esas teclas, ver „Modo Especial" página 125.

 Pulse repetidamente las teclas Pasar "<" o bien ">" (fig. 5), hasta que se encienda el símbolo .

 Confirme con la tecla "OK" (fig. 5).

E

El display muestra la configuración actual. Las temperaturas se muestran como sigue:

-  Temperatura baja
-  Temperatura media
-  Temperatura alta

 Seleccione igualmente con las teclas para desplazarse "<" o ">" (fig. 5) otra temperatura.

 Cuando aparezca la temperatura deseada, confírmela con la tecla "OK" (fig. 5). Este temperatura quedará así programada.

 Para cancelar el proceso sin almacenar cambios, pulsar "P" en lugar de "OK".

 Si aprox. tras 120 segundos no se pulsa "OK" el aparato volverá automáticamente al modo de café anterior sin memorizar las modificaciones.

 Para volver al modo de café, pulse, a continuación, la tecla "P" (fig. 4) o espere unos 120 seg., hasta que el aparato vuelva automáticamente al modo de café.

## 13 Limpieza y cuidados

Mantenga su máquina de café siempre limpia para obtener una calidad del café constante y un funcionamiento sin problemas.

### 13.1 Limpieza regular

 ¡Atención! Apague el aparato antes de limpiarlo. Deje que se enfríe.

 ¡Atención! No lave nunca el aparato o sus componentes en el lavavajillas. Nunca sumerja la máquina de café en el agua.

 ¡Atención! Nunca introduzca agua en el contenedor de granos ya que esto dañaría el molinillo.

 No utilice medios abrasivos o cáusticos o que puedan causar rayones. Limpie la carcasa por dentro y por fuera únicamente con un trapo húmedo.

 Extraiga todos los días el depósito de agua (fig. 6) y sacuda los restos de agua. Aclare el depósito de agua con agua clara. Utilice todos los días agua clara y fresca.

 Vacíe el contenedor de residuos diariamente o al menos cuando la pantalla así se lo indique, ver „Vaciar el contenedor de residuos" página 134.

 Vacíe la bandeja recogegotas regularmente. Como muy tarde cuando el flotador rojo de la bandeja recogegotas (fig. 28) aparezca a través de la apertura de la rejilla de goteo.



 Lave con regularidad, al menos una vez por semana, el depósito de agua (N), la bandeja recogegotas (O), la rejilla de goteo (A) y el contenedor de residuos (Q) con agua templada, detergente suave, y si fuera necesario, con un pincel.

 Cada vez que espume la leche, deberá extraer la tobera de vapor y limpiarla a fondo de restos de leche, ver „Limpiar la tobera de vapor" página 132.

 Compruebe que las bocas de la salida de café no están obturadas. Para limpiarlas puede utilizar una aguja para retirar el café seco (fig. 29).

### 13.2 Vaciar el contenedor de residuos



El aparato cuenta el número de cafés preparados. Tras cada 14 cafés preparados (o 7 dobles), el símbolo  se ilumina para avisar de que el depósito de restos de café está lleno y debe ser vaciado y limpiado. Mientras no se limpie el depósito, la cafetera no podrá preparar café.

 Para proceder con la limpieza, abrir la compuerta de servicio pulsando el botón de apertura de la misma (fig. 30). Se iluminará el símbolo .

 Sacar entonces la bandeja de recogida (fig. 31), vaciarla y limpiarla.







 Vacíe y limpie con cuidado el contenedor de residuos. Asegúrese de que elimina todos los sedimentos depositados en el fondo.

**Importante:** Cada vez que extraiga la bandeja recogegotas, debe también vaciar el contenedor de residuos, incluso aunque no esté lleno. Si no se hiciera así, puede ocurrir que en las siguientes preparaciones de café, el contenedor de residuos esté demasiado lleno y el excesivo poso de café obstruya la máquina de café.

-  Cuando se ha retirado la bandeja de recogida, parpadeará el símbolo .
-  Si utiliza el aparato diariamente, vacíe también el contenedor diariamente. Vacíe el contenedor de residuos siempre estando el aparato encendido. Sólo entonces el aparato reconocerá el vaciado.

### 13.3 Limpieza del molinillo

Los restos del café pueden retirarse del contenedor de café con un pincel suave o con un aspirador.









-  ¡Atención! Nunca introduzca agua en el molinillo, porque se dañaría.
-  Apague el aparato con la tecla de Encendido/Apagado (fig. 11) y el interruptor principal (fig. 8). Tire del enchufe de red.
-  Retire los restos de granos de café (utilizando un aspirador con tubo o tobera de juntas).
-  Si no pudiera retirarse un cuerpo extraño, dirijase al servicio al cliente. **La garantía puede no tener validez si el molinillo se bloquea o se daña por efecto de un cuerpo extraño.**
-  ¡Atención! Peligro de lesiones cuando el molinillo está funcionando. No conecte nunca el aparato cuando esté trabajando en el molinillo. Esto podría causar lesiones gravísimas. Desenchufe siempre el aparato de la red.
-  Compruebe con una pequeña cantidad de granos el funcionamiento del molinillo, preparando un café. Durante la primera molienda o tras la limpieza pasará menor cantidad de café en polvo a la unidad de infusión, puesto

que el canal tiene que llenarse. Esto podría influir en la calidad del primer café.

### 13.4 Limpieza de la unidad de infusiones

Le recomendamos que limpie la unidad de infusiones (según el grado de utilización) regularmente. Si no va a usar su aparato durante un largo periodo de tiempo (por ej. vacaciones), es necesario que vacíe el contenedor de residuos y el depósito de agua y que limpie a fondo el aparato, incluida la unidad de infusiones.

Proceda del siguiente modo:

-  Apagar la cafetera pulsando la tecla de conexión / desconexión (fig. 11) (no desenchufar la clavija de la red) y esperar a que se hayan apagado todos los símbolos!
-  Desbloquee la puerta de servicio presionando el mando de apertura correspondiente y ábrala (fig. 30).
-  Extraiga la bandeja recogegotas y el contenedor de residuos (fig. 31) y límpielos.
-  Presione las dos teclas de desbloqueo de la unidad de infusiones lateralmente y contra el centro (fig. 32) y extraiga la unidad de infusiones.
-  **Atención:** La unidad de infusiones sólo podrá extraerse, si el aparato está apagado con la tecla de encendido/apagado  de la parte frontal del aparato. El aparato no debe desenchufarse de la red eléctrica. Si intenta extraer la unidad de infusiones estando la máquina de café encendida, podría dañar gravemente dicha unidad.
-  Limpie la unidad de infusiones bajo el agua del grifo sin utilizar detergentes. **No limpie la unidad de infusiones en el lavavajillas.**
-  Limpie el interior de la máquina con mucho cuidado. Rasque las incrustaciones de café de la máquina con un tenedor de madera o de plástico o algo similar que no raye la superficie,

E

(fig. 33) y aspire todos los sedimentos después con un aspirador (fig. 34).









-  Para colocarlas de nuevo, inserte la unidad de infusiones (fig. 36, a) en el soporte (fig. 36, b) y el pasador (fig. 36, c). El pasador debe introducirse en el tubo (fig. 36, d) en la parte inferior de la unidad de infusiones.
-  Ahora presione firmemente sobre el letrero PUSH (fig. 36, e), hasta que escuche cómo encaja la unidad de infusiones.
-  Asegúrese de que después de haber oído cómo encajaba la unidad, las teclas rojas (fig. 36, f) sobresalen, si no la puerta de servicio no estaría cerrada.
 

figura 37: Las dos teclas rojas han salido correctamente.

figura 38: Las dos teclas rojas no han salido correctamente.
-  Coloque de nuevo la bandeja recogegotas junto con el contenedor de residuos.
-  Cierre la puerta de servicio.
-  Si la unidad de infusiones no está correctamente colocada, es decir hasta que se oiga un clic al encajar, y las teclas rojas no sobresalen correctamente, la compuerta de servicio no podrá cerrarse.
-  Si sólo puede colocarse la unidad de infusiones con dificultad, ésta deberá llevarse (antes de colocarla) a la altura correcta, exactamente presionando firme y uniformemente la unidad de infusiones desde abajo y desde arriba, como aparece representado en la figura 35.
-  Si aún así tiene dificultades para colocar la unidad de infusiones, cierre la puerta de servicio, desenchufe el cable de alimentación y vuelva a enchufarlo. Espere hasta que se apaguen todos los símbolos; sólo entonces abra la puerta de servicio y vuelva a colocar la unidad de infusiones en su lugar

### 13.5 Ejecución del programa de descalcificación

El programa de descalcificación permite una descalcificación sencilla y efectiva de su aparato. Cuando el correspondiente símbolo  así lo indique, la cafetera se deberá descalcificar.



**Atención:** Nunca utilice cualquier descalcificador que no haya sido recomendado por AEG/Electrolux. Si se utilizan otros descalcificadores, AEG/Electrolux no asumirá ninguna responsabilidad por eventuales daños. Los descalcificadores pueden adquirirse en los establecimientos especializados o en la línea de servicio de AEG/Electrolux.







El proceso de descalcificación dura unos 45 minutos y no debería interrumpirse. En caso de apagón, el programa deberá reiniciarse nuevamente.



Antes de iniciar el programa de descalcificación, limpie la unidad de infusiones (ver „Limpieza de la unidad de infusiones" página 135).





Pulse la tecla "P" (fig. 4).

Se iluminan los símbolos "P" y . Además se iluminan los 3 pequeños símbolos sobre las teclas ,  y , para indicar la función momentánea de esas teclas, ver „Modo Especial" página 125.



Pulse repetidamente las teclas Pasar "<" o bien ">" (fig. 5), hasta que se encienda el símbolo .



Confirme con la tecla "OK" (fig. 5). Los símbolos  y  parpadean y "P" permanece encendido.





Para interrumpir el programa de descalcificación en este punto, desconectar la cafetera con la tecla de conexión / desconexión  (fig. 11).







Vacíe el depósito de agua, llénelo con un mínimo de 1 litro de agua y añada el descalcificador.







 **Atención:** Asegúrese de que el descalcificador no salpique sobre superficies sensibles a los ácidos como mármol, piedra caliza y cerámica.

 Coloque un recipiente con una capacidad mínima de 1,5 litros debajo de la tobera de vapor (fig. 9).

 Coloque el mando giratorio para vapor y agua caliente en la posición . El programa de descalcificación se iniciará y el líquido descalcificador saldrá de la tobera de vapor. Los símbolos ,  y "P" permanecen iluminados.

El programa de descalcificación realiza automáticamente una serie de aclarados y pausas para eliminar las incrustaciones de cal del interior de la máquina de café.





Tras aprox. 30 minutos, el depósito del agua estará vacío y los símbolos  y  parpadean, mientras "P" permanece iluminado.



 Coloque el mando giratorio para vapor y agua caliente de nuevo en la posición .



El aparato ya está listo para un aclarado con agua fresca.



 Extraiga el depósito de agua, llénelo con agua fresca y vuélvalo a colocar.

 Vacíe el recipiente de debajo de la tobera de vapor y colóquelo de nuevo bajo la tobera de vapor.

 Coloque el mando giratorio para vapor y agua caliente en la posición . Ahora tendrá lugar un proceso de aclarado con agua fresca y el agua del aclarado saldrá por la tobera de vapor. Los símbolos ,  y "P" permanecen iluminados.

Tras varios minutos, el depósito del agua estará vacío y los símbolos  y  parpadean, mientras "P" permanece iluminado.

 Coloque el mando giratorio para vapor y agua caliente de nuevo en la posición .

 Se mostrarán los símbolos correspondientes al último Modo Café seleccionado, y el símbolo  permanece iluminado.

 Vacíe el recipiente con el agua de aclarado.

 Extraiga el depósito de agua, llénelo con agua fresca y vuélvalo a colocar. El aparato ya está de nuevo listo para su funcionamiento y en el estado del último modo de café configurado.

 Recomendamos que tire la primera taza de café que prepare después del proceso de descalcificación.

## 14 Pedido de accesorios

Para que pueda disfrutar durante mucho tiempo de su aparato y evitar defectos prematuros, es muy importante que limpie y descalcifique su aparato con regularidad. Si lo desea también puede hacernos un pedido directo del producto descalcificador original.

Por favor, dirijase a nuestra línea de pedidos en Alemania:

1801 - 20 30 60\*

(\*tarifa local desde la red telefónica de Deutsche Telekom)  
lunes a viernes de 8:00 - 18:00 horas

## 15 Qué hacer cuando en la pantalla aparece el siguiente mensaje...

**El símbolo  permanece iluminado**

- El depósito de agua está vacío o no está bien colocado.

 Llene el depósito de agua y colóquelo correctamente, consulte „Añadir agua" página 125.

- El depósito de agua está sucio o se ha formado una costra de cal.

 Aclare o descalcifique el depósito de agua.

E

**Los símbolos ☰ y △ parpadean**

- La máquina de café no puede preparar ningún café.
- ☞ Coloque un recipiente bajo la tobera de vapor y gire el mando giratorio para vapor y agua caliente en sentido contrario a las agujas del reloj a la posición ☰ (fig. 9).
- El café sale muy lentamente.
- ☞ Girar una posición el mando del ajuste del grado de molienda (fig. 12) en sentido horario, mientras esté funcionando el molinillo durante una preparación de café con café en grano (consulte „Ajustar el molinillo“ página 133).

**El símbolo ☒ permanece iluminado**

- El contenedor de residuos está lleno.
- ☞ Vacíe, limpie y vuelva a colocar en su sitio el recipiente de residuos como se indica en „Vaciar el contenedor de residuos“ página 134.

**El símbolo ☒ parpadea**

- El contenedor de residuos no se puso en su sitio después de la limpieza.
- ☞ Abra la puerta de servicio y coloque el contenedor de residuos.

**Los símbolos ☞ o ☞ y △ parpadean**

- Tras haber seleccionado la función para café premolido, no se llenó el compartimiento con café en polvo.
- ☞ Rellene con café en polvo como se indica en „Preparar café con café molido“ página 130.

**Todos los símbolos para el café cargado-flojo ☰ y △ parpadean**

- No hay ningún grano de café en el contenedor de granos de café.
- ☞ Llene el contenedor de granos de café, consulte „Llenar el contenedor de granos de café“ página 125.
- Si el molinillo hace demasiado ruido, esto puede indicar que una pequeña piedra en los granos de café ha bloqueado el molinillo.

- ☞ Diríjase al servicio al cliente. La garantía puede no tener validez si el molinillo se bloquea o se daña por efecto de un cuerpo extraño.

**El símbolo ☒ permanece encendido**

- Indica que la máquina de café contiene incrustaciones de cal.
- ☞ El programa de descalcificación descrito en el capítulo „Ejecución del programa de descalcificación“ página 136 debe llevarse a cabo lo antes posible.

**El símbolo ☒ permanece encendido**

- La puerta de servicio está abierta.
- ☞ Cierre la puerta de servicio. Si no pudiera cerrarse la puerta de servicio, asegúrese de que la unidad de infusiones está correctamente colocada (consulte „Limpieza de la unidad de infusiones“ página 135)

**El símbolo △ parpadea**

- Posiblemente se olvidó de insertar de nuevo en la máquina la unidad de infusiones después de realizar una limpieza.
- ☞ Coloque la unidad de infusiones, consulte „Limpieza de la unidad de infusiones“ página 135
- El interior de la máquina está muy sucio.
- ☞ Limpie el interior de la máquina con mucho cuidado, consulte „Limpieza de la unidad de infusiones“ página 135. Si aún después de limpiar la máquina de café sigue apareciendo el mensaje anterior, diríjase, por favor, al servicio al cliente.

**El símbolo △ permanece encendido**

- Esto indica una alarma de fallo general.
- ☞ Póngase en contacto con el Servicio Postventa.

**Los símbolos ☰ y △ parpadean**

- La cafetera se conectó con el mando giratorio para vapor y agua caliente en la posición "abierto" ☰.
- ☞ Girar el mando para vapor y agua caliente en sentido horario (fig. 10) hasta el tope a la posición ●.

**Los símbolos  y  parpadean**

- La temperatura ambiente es demasiado baja para utilizar el aparato.
-  Utilice el aparato en una habitación más caliente.



**16 Problemas resolubles, antes de que llame al servicio al cliente**

Si la máquina de café no funciona, puede buscar fácilmente la causa del problema y solucionarlo consultando el capítulo „Qué hacer cuando en la pantalla aparece el siguiente mensaje...” página 137. Si por contra la cafetera no indica ningún símbolo, compruebe por favor los siguientes puntos antes de ponerse en contacto con el Servicio Postventa.

**El café no está caliente**

- Las tazas no se precalentaron.
-  Caliente las tazas aclarándolas con agua caliente o colocándolas durante al menos 20 minutos sobre la bandeja calentatazas (H) (consulte „Consejos para preparar un café caliente:” página 129).

**El café tiene poca crema**

- El café está molido demasiado grueso.
-  Gire el mando para el ajuste del grado de molienda una posición en sentido contrario, mientras esté funcionando el molinillo durante una preparación de café con café en grano (ver „Ajustar el molinillo” página 133).
- La mezcla de café no es adecuada.
-  Utilice una mezcla de café apropiada para máquinas de café automáticas.

**El café sale muy lentamente**

- El café está molido demasiado fino.
-  Gire una posición el mando para el ajuste del grado de molienda en sentido horario, mientras esté funcionando el molinillo durante una preparación de café con café en grano (ver „Ajustar el molinillo” página 133).

**El café sale demasiado rápido**



- El café está molido demasiado grueso.
-  Gire el mando para el ajuste del grado de molienda una posición en sentido contrario, mientras esté funcionando el molinillo durante una preparación de café con café en grano (ver „Ajustar el molinillo” página 133).

**El café sale sólo por una de las salidas de café**

- Los agujeros de las salidas están obstruidos.
-  Elimine el café seco con una aguja (fig. 29).

**A pesar de girar el mando para vapor y agua caliente, no sale vapor de la tobera**

- Los pequeños orificios de la tobera de vapor y el interior de la tobera están obstruidos.
-  Limpie los pequeños orificios de la tobera de vapor y el interior de la tobera (consulte „Limpiar la tobera de vapor” página 132).

**Si se ha seleccionado la función  o , no sale café sino agua de la máquina**

- El polvo de café podría haberse quedado atascado en el compartimento para café molido.
-  Retire el polvo de café que obstruye el compartimento para café molido utilizando un cuchillo (consulte „Preparar café con café molido” página 130) (fig. 22). Limpie a continuación la unidad de infusiones y el interior de la máquina (consulte „Limpieza de la unidad de infusiones” página 135)

**Al presionar la tecla  no se enciende la máquina**

- El interruptor principal de la parte posterior del aparato no está conectado (fig. 8) o no está enchufado a la red.
-  Compruebe que el interruptor principal se halla en la posición "I" y que el cable de alimentación está bien enchufado.

E

### No puede extraerse la unidad de infusiones para su limpieza



- La máquina de café está encendida. La unidad de infusiones sólo puede extraerse si la máquina está apagada.
- ☞ Desconecte el aparato y extraiga la unidad de infusiones (consulte „Limpieza de la unidad de infusiones“ página 135).

**i** Atención: La unidad de infusiones sólo podrá extraerse, se el aparato está apagado con la tecla de encendido/apagado  de la parte frontal del aparato. El aparato no debe desenchufarse de la red eléctrica. Si intenta extraer la unidad de infusiones estando la máquina de café encendida, podría dañar gravemente dicha unidad.

### El café no sale de las bocas de la salida de café, sino por el lateral por la puerta de servicio

- Las bocas de la salida de café están atascadas con café seco.
- ☞ Elimine el café seco con una aguja (fig. 29).
- El compartimento basculante (R) situado en el interior de la compuerta de servicio está bloqueado y no oscila.
- ☞ Limpie el compartimento basculante con cuidado, especialmente cerca de los goznes para que puedan moverse.

### Se utilizó café en polvo (en lugar de granos de café) y no sale ningún café

- Se rellenó con demasiado café molido.
- ☞ Extraiga la unidad de infusiones y limpie el interior de la máquina de café como se describe en „Limpieza de la unidad de infusiones“ página 135". Repita el proceso y utilice como máximo 2 cucharadas de medida rasas.
- El mando giratorio "Gusto de café / café premolido" no se colocó en la posición  o  y el aparato ha utilizado tanto el café premolido como el café molido del molinillo.

☞ Limpie el interior de la máquina de café cuidadosamente, como se describe en „Limpieza de la unidad de infusiones“ página 135". Repita el proceso, colocando para ello primero el mando giratorio "Gusto de café / café premolido" en la posición correcta como se describe en „Preparar café con café molido" página 130.

- Se rellenó café premolido estando la máquina apagada.

☞ Extraiga la unidad de infusiones y limpie el interior de la máquina de café como se describe en „Limpieza de la unidad de infusiones" página 135". Repita el proceso con la máquina encendida.

### ¿Qué hacer cuando deba transportar la máquina?

- Guarde el embalaje original como protección para el transporte. Utilice la bolsa de plástico original para protegerlo de rayones.
- Asegure el aparato y la jarra térmica contra los golpes. No se asumirá ninguna garantía por los daños causados durante el transporte.
- Vacíe el depósito de agua y el contenedor de residuos.
- Por favor, tenga en cuenta el lugar de ubicación del aparato, especialmente durante la estación fría del año. Pueden ocasionarse daños por congelación.

## 17 Modo Estadística

La cafetera ofrece la posibilidad de requerir los siguientes valores:





- el número total de cafés preparados con la cafetera hasta el momento,
- el número de jarras preparadas con 4, 6, 8 y 10 tazas,
- el número de las descalcificaciones realizadas, y además,
- la cantidad de litros de agua que se han utilizado con la cafetera.

**i** Cuando se sirven 2 tazas de café simultáneamente, las mismas se cuentan también como 2 tazas.

Para conectar el Modo Estadística, la cafetera debe estar apagada.

**☞** Si fuera necesario, desconectar la cafetera con la tecla "Conexión / Desconexión"  (fig. 11).

**☞** Mantener pulsada la tecla "P" (fig. 4) durante 6 segundos como mínimo.

Se iluminarán los símbolos "P" y . Además se iluminan los 3 pequeños símbolos sobre las teclas ,  y , para indicar la función momentánea de esas teclas, ver „Modo Especial" página 125.

**☞** Pulse repetidamente las teclas Pasar "<" o bien ">" (fig. 5), hasta que se ilumine el símbolo del cual se quiere conocer la estadística:

 Número de cafés preparados

 Número de descalcificaciones realizadas

 4 Número de jarras preparadas con 4 tazas

 6 Número de jarras preparadas con 6 tazas

 8 Número de jarras preparadas con 8 tazas

 10 Número de jarras preparadas con 10 tazas

 Cantidad de litros de agua que se han utilizado con la cafetera

Cuando se ilumina un símbolo, podrá hacer que la cifra correspondiente se indique como sigue:

**☞** Mantener pulsada la tecla "OK" (fig. 5). Ahora comenzarán a parpadear sucesivamente los mensajes, con lo que se indica la cifra requerida:

 cada parpadeo significa 1

 cada parpadeo significa 10

 cada parpadeo significa 100

 cada parpadeo significa 1,000

 cada parpadeo significa 10,000

La indicación por parpadeo se repetirá mientras se mantenga pulsada la tecla "OK". Antes de cada repetición se realiza una pausa de 3 segundos.

**☞** Podrá contar el número de parpadeos y sumarlos.

Ejemplo: la siguiente secuencia de parpadeos corresponde al número 1.529.

 9 parpadeos

 2 parpadeos

 5 parpadeos

 1 parpadeo

 ningún parpadeo

**☞** Para salir del Modo Estadística, mantener pulsada la tecla "P" (fig. 4) durante como mínimo 6 segundos.

## 18 Datos técnicos

Tensión de red: 220-240 V

Consumo de potencia: 1350 W

**CE** Este aparato es conforme con las siguientes directivas CE:

- 73/23/CEE de 19 de febrero de 1973 "Directiva de baja tensión", incluida la directiva de modificación 93/68/CEE.
- 89/336/CEE de 3 de mayo de 1989 "Directiva de compatibilidad electromagnética", incluida la directiva de modificación 92/31/CEE.

E

## 19 Eliminación



### Material de embalaje

Los materiales de embalaje son compatibles con el medio ambiente y reutilizables. Las piezas de plástico están identificadas, por ejemplo >PE<, >PS< etc. Deshágase de los materiales de embalaje según su identificación en los contenedores previstos para ellos en los lugares de recogida de deshechos.



### Aparatos viejos

El símbolo  sobre el producto o en su embalaje indica que este producto no puede eliminarse como basura doméstica sino que debe entregarse en los puntos de recogida para el reciclaje de aparatos eléctricos y electrónicos. Con su colaboración en la correcta eliminación de este producto, protegerá el medio ambiente y la salud de todos nosotros. Una eliminación incorrecta pone en peligro el medio ambiente y la salud. Si desea más información sobre el reciclaje de este producto, diríjase a su ayuntamiento, al organismo encargado de la eliminación de deshechos o al establecimiento en el que adquirió este producto.

## 20 En caso de reparaciones

Conserve sin falta, el embalaje original junto con las piezas de espuma. Para evitar daños durante el transporte, el aparato deberá estar bien embalado. Cuando vaya a enviar el aparato, recuerde siempre de adjuntar la jarra térmica. Ya que se necesita para probar el aparato.

**P** **Prezada Cliente,  
Prezado Cliente,**

por favor leia atentamente as instruções que se seguem. Tenha em especial atenção as instruções de segurança! Guarde estas instruções para consulta futura e passe as instruções a qualquer eventual futuro proprietário da máquina.

## Índice

<b>1</b>	<b>Legenda de figura</b>	<b>144</b>	<b>10</b>	<b>Preparação de água quente</b>	<b>155</b>
1.1	Vista frontal (Figura 1)	144	<b>11</b>	<b>Regular moinho</b>	<b>155</b>
1.2	Vista frontal com a porta de serviço aberta (Figura 2)	144	<b>12</b>	<b>Regulação da temperatura do café</b>	<b>156</b>
1.3	Painel de controlo (Figura 3)	144	<b>13</b>	<b>Limpeza e cuidados</b>	<b>156</b>
<b>2</b>	<b>Café e café expresso</b>	<b>145</b>	13.1	Limpeza regular	156
<b>3</b>	<b>Instruções de segurança</b>	<b>145</b>	13.2	Esvaziar o depósito das borras	157
<b>4</b>	<b>Modo especial</b>	<b>147</b>	13.3	Limpar o moinho	157
<b>5</b>	<b>Primeira colocação em funcionamento</b>	<b>147</b>	13.4	Limpar a unidade de infusão	157
5.1	Montar e ligar o aparelho	147	13.5	Realizar o programa de descalcificação	158
5.2	Colocar água	147	<b>14</b>	<b>Encomenda de acessórios</b>	<b>160</b>
5.3	Encher o recipiente dos grãos de café	148	<b>15</b>	<b>Como proceder quando o display exhibe a seguinte mensagem...</b>	<b>160</b>
5.4	Primeira ligação	148	<b>16</b>	<b>Problemas com solução, antes de contactar o serviço de assistência técnica</b>	<b>161</b>
5.5	Ligar o aparelho	148	<b>17</b>	<b>Modo de estatística</b>	<b>163</b>
5.6	Desligar o aparelho.	149	<b>18</b>	<b>Dados técnicos</b>	<b>164</b>
5.7	Definir a dureza da água	149	<b>19</b>	<b>Eliminação</b>	<b>164</b>
<b>6</b>	<b>Preparar café com grãos</b>	<b>150</b>	<b>20</b>	<b>Em caso de assistência</b>	<b>164</b>
6.1	Sugestões para servir café mais quente	151			
<b>7</b>	<b>Preparar várias chávenas de café com a função de jarro</b>	<b>151</b>			
<b>8</b>	<b>Preparar café com café moído</b>	<b>152</b>			
<b>9</b>	<b>Espuma de leite</b>	<b>153</b>			
9.1	Limpar o bocal de vapor	154			

P

## 1 Legenda de figura















### 1.1 Vista frontal (Figura 1)

- A Grelha de gotejamento
- B Jarro de café
- C Interruptor principal (parte posterior da máquina)
- D Saída de café regulável em altura
- E Painel de controlo (ver Figura 3)
- F Tampa do recipiente dos grãos de café
- G Tampa do compartimento do café moído
- H Tabuleiro de aquecimento de chávemas
- J Tubo oscilante de vapor e água quente
- K Bocal de vapor (amovível)
- K Parte interior do bocal de vapor (amovível)
- M Botão de abertura para a porta de serviço
- N Depósito da água com marca de enchimento máximo (amovível)
- O Colector de gotas com flutuador (amovível)

### 1.2 Vista frontal com a porta de serviço aberta (Figura 2)

- P Porta de serviço (aberta)
- Q Depósito das borras (amovível)
- R Compartimento oscilante
- S Unidade de infusão
- T Botão para a regulação do grau de moagem
- U Recipiente dos grãos de café
- V Colher de medida
- W Compartimento de enchimento para café pré-moído
- X Placa de características (parte inferior da máquina)
- Y Descalcificador líquido
- Z Tira reagente

### 1.3 Painel de controlo (Figura 3)

- a Botão "aroma do café / café pré-moído"
- b Botão "Tamanho da chávena"
- c Display
- d Botão "1 chávena de café"   
No Modo Especial, esta tecla serve para "folhear" ("<")
- d Botão "2 chávemas de café"   
No Modo Especial, esta tecla serve para "folhear" (">")
- f Botão "Vapor"   
No modo especial, esta tecla acciona o ponto do menu ("OK")
- g Botão "P"  
No modo especial, esta tecla regressa ao último nível, sem efectuar alterações ("P")
- h Botão "Ligar/Desligar" 
- J Botão de vapor e água quente
- k Botão "Função café de jarro" 
- l Símbolos "Café Pré-moído"
- m Símbolos "Jarro"
- n Símbolos "Intensidade do café"
- o Símbolos "Tamanho da chávena"
- p Símbolo "Depósito de água vazio" 
- q Símbolo "Descalcificação" 
- r Símbolo "Temperatura do aparelho" 
- s Símbolo "Porta de serviço aberta" 
- t Símbolo "Depósito de borras" 
- u Símbolo "Atenção" 
- v Símbolo "Água quente" 
- w Símbolo "Vapor" 
- x Símbolo "Preparação de 2 chávemas" 
- y Símbolo "Preparação de 1 chávena" 
- z Símbolos para o modo especial



## 2 Café e café expresso

O funcionamento da sua máquina de café automática garante-lhe uma **utilização**, muito simples, tanto na preparação do café como na manutenção e nos cuidados.

O aroma **excelente e individual** é obtido através do

- sistema de pré-infusão: antes do verdadeiro processo de infusão, o café moído é humedecido para ser retirado todo o aroma,
- a quantidade de água por chávena individualmente regulável entre um expresso curto e um café "comprido" com creme,
- a temperatura do café, individualmente regulável, com a qual é preparada a infusão do café,
- a possibilidade de escolha entre uma chávena de café normal ou forte,
- o grau de moagem regulável em função da torrefacção dos grãos de café,
- e, por fim, pela garantia do creme, aquela espuma que torna o café expresso tão incomparável para os conhecedores.

**Aliás:** No caso do café expresso, o tempo de contacto da água com o café é consideravelmente menor do que com o tradicional café de filtro. Desta forma são extraídas menos substâncias amargas do café moído, tornando a digestão do café expresso mais fácil!

## 3 Instruções de segurança



A segurança deste aparelho corresponde às normas técnicas reconhecidas e às normas de segurança dos aparelhos. Contudo, na qualidade de fabricantes deste aparelho, pedimos-lhe que se familiarize com as instruções de segurança que se seguem.

### Segurança geral

- Antes de ligar a máquina à rede de alimentação, certifique-se de que a tensão, o tipo e a frequência da rede coincidem com os dados indicados na placa de características (que se encontra na parte inferior da máquina)!
- Não deve permitir o contacto do cabo de alimentação com peças da máquina que estejam quentes.
- Nunca retire a ficha da máquina puxando pelo cabo de alimentação!
- Não colocar a máquina em funcionamento caso:
  - O cabo esteja danificado ou
  - a caixa apresente danos visíveis.
- Ligar a ficha à tomada eléctrica apenas com a máquina desligada.
- Esta máquina não se destina a ser utilizada por pessoas (inclusive crianças) com capacidades físicas, sensoriais ou mentais reduzidas ou falta de experiência e conhecimento, a não ser que tenha havido uma supervisão inicial ou elas tenham recebido instruções quanto à utilização segura desta máquina por parte de uma pessoa responsável.

### Segurança das crianças

- Nunca deixe a máquina a funcionar sem vigilância e esteja especialmente atento na presença de crianças!
- Os materiais de embalagem, tais como saquinhos plásticos, devem ser mantidos fora do alcance de crianças.

P

### Segurança durante o funcionamento

- **Atenção!** Durante o funcionamento, a saída do café, o tabuleiro de aquecimento de chávenas e o bocal de vapor aquecem. Manter fora do alcance das crianças!
- **Atenção!** Com o bocal de vapor em funcionamento existe perigo de queimadura! A água quente ou o vapor de água quente que sai da máquina pode provocar queimaduras. Coloque o bocal de vapor apenas em funcionamento se mantiver um recipiente por baixo do mesmo.
- Não aqueça líquidos inflamáveis com vapor!
- Utilize a máquina apenas se a mesma tiver água no seu sistema! Encha o depósito da água apenas com água fria e não com água quente, leite ou outros líquidos. Respeite o nível de enchimento máximo, de aproximadamente 1,8 litros.
- Não coloque grãos de café congelados ou caramelizados no recipiente dos mesmos, apenas grãos de café torrados! Retire todos os objectos estranhos, como por exemplo pequenas pedras, dos grãos de café. Se o mecanismo de moagem ficar bloqueado e danificado devido a um objecto estranho, isso poderá eventualmente não estar coberto pela garantia.
- Colocar apenas café moído na entrada destinada a esse fim.
- Não deixar a máquina ligada desnecessariamente.
- Não expor a máquina aos efeitos de condições atmosféricas.
- Ao utilizar uma extensão, deverá utilizar apenas um cabo normal com um diâmetro mínimo do condutor de 1,5 mm<sup>2</sup>.
- As pessoas com problemas motores não devem utilizar esta máquina sem acompanhamento, a fim de evitar a exposição a riscos.

- Utilizar esta máquina apenas se o colector de gotas, o depósito das borras e a grelha de gotejamento estiverem instalados!

### Segurança durante a limpeza e os cuidados

- Respeitar as indicações de limpeza e descalcificação.
- Desligar a máquina e retirar a ficha da tomada antes de proceder à manutenção ou limpeza!
- Não mergulhar a máquina em água.
- Limpar o bocal de vapor apenas com a máquina desligada, fria e sem pressão!
- Não lavar as peças do aparelho na máquina de lavar loiça.
- **Nunca colocar água no moinho**, pois irá danificar o mecanismo de moagem.

Não abrir nem proceder a reparações no aparelho. Reparções inadequadas podem constituir perigos consideráveis para o utilizador.



Reparação em aparelhos eléctricos devem ser efectuados unicamente por técnicos especializados.



Caso seja necessária uma reparação, inclusive a substituição da ficha, contacte o

- revendedor onde adquiriu o aparelho ou
- a linha de assistência técnica AEG/ Electrolux.

Caso o aparelho seja utilizado incorrecta ou indevidamente, não poderá ser assumida responsabilidade por eventuais danos ou pela garantia – o mesmo aplica-se, caso o programa de descalcificação não for realizado imediatamente após o aparecimento do símbolo  e de acordo com as indicações deste manual de instruções. Se o mecanismo de moagem ficar bloqueado e danificado devido a um objecto estranho, isto poderá eventualmente não estar coberto pela garantia.

## 4 Modo especial

Para a regulação da dureza da água („Definir a dureza da água” página 149) e da temperatura do café („Regulação da temperatura do café” página 156), para iniciar o programa de descalcificação („Realizar o programa de descalcificação” página 158) e consultar a estatística („Modo de estatística” página 163), entra-se no modo especial premindo a tecla "P" (Figura 4). No modo especial, as teclas "1 Chávena de café" , "2 Chávenas de café" , "Vapor"  e "P" servem para navegar. A respectiva função é indicada no display, por cima do botão (Figura 5):

- os botões «<» ("1 chávena de café" ) e «>» ("2 chávenas de café" ) permitem "folhear" no menu
- o botão «OK» ("Vapor" ) confirma um ponto
- o botão «P» ("P") regressa ao nível anterior, sem realizar qualquer modificação

## 5 Primeira colocação em funcionamento

### 5.1 Montar e ligar o aparelho

Escolha uma superfície adequada, horizontal, estável, não aquecida, seca e à prova de água.

-  Certifique-se de que existe boa circulação de ar. Nas partes laterais e na parte posterior do aparelho é necessário um espaço livre de, pelo menos, 5 cm e, por cima do aparelho esse espaço deve ser de, pelo menos, 20 cm.

O aparelho não pode ser montado em compartimentos com temperaturas de 0 °C ou inferiores (com água congelada, o aparelho é danificado).

-  **Atenção!** Quando o aparelho é mudado de um ambiente frio para um compartimento quente, é necessário aguardar aprox. 2 horas antes de se poder ligar!

Recomendamos que o aparelho seja colocado em cima de uma base adequada, para evitar danos causados por salpicos.

-  Ligar o aparelho exclusivamente a uma tomada com ligação à terra. Não utilizar nunca uma tomada sem ligação à terra.

### 5.2 Colocar água

Antes de ligar o aparelho, certifique-se de que existe água no depósito e, se necessário, encha até ao nível adequado. Sempre que o aparelho é ligado e desligado, este necessita de água para os ciclos de lavagem automáticos.

-  Retire o depósito da água do aparelho (Figura 6). Antes de retirar o depósito da água, rode sempre e o bocal de vapor para o sentido central do aparelho, caso contrário este não poderá ser retirado.

-  Encha o depósito da água com água fria e limpa. Nunca encha o depósito para lá da marca de enchimento máximo.

-  O depósito da água deve apenas ser enchido com água fria. Nunca utilizar outros líquidos como, por exemplo, água mineral ou leite.

-  Volte a colocar o depósito da água no aparelho (Figura 6). Pressione bem o depósito, para que a válvula do mesmo se abra.

-  Para obter sempre um café aromático deverá:

- Mudar diariamente a água do depósito da água,
- limpar o depósito da água pelo menos uma vez por semana com água de lavagem normal (não na máquina de lavar loiça). Em seguida, enxaguar com água limpa.

P

### 5.3 Encher o recipiente dos grãos de café

 Abra a tampa do recipiente dos grãos de café e encha-o com grãos de café frescos (Figura 7). Em seguida, volte a fechar a tampa.

 **Atenção!** Certifique-se de que utiliza apenas grãos puros, sem adição de ingredientes caramelizadas ou aromatizadas e grãos congelados. Certifique-se de que não entram objectos estranhos para este recipiente como, por exemplo, pequenas pedras. Se o mecanismo de moagem ficar bloqueado ou danificado devido a um objecto estranho, isto poderá eventualmente não estar coberto pela garantia.

 O grau de moagem do moinho vem predefinido de fábrica como médio. Caso necessário, pode alterar esta definição. Encontrará indicações sobre a alteração do grau de moagem em „Regular moinho“ página 155.

 O grau de moagem pode apenas ser alterado durante o processo de moagem. A alteração destas definições com o moinho desactivado pode danificar a máquina de café.

 A máquina de café foi testada na fábrica. Para esse processo foi utilizado café, pelo que será normal encontrar algum café no moinho. Em todo o caso, garantimos de que esta máquina de café é nova.

### 5.4 Primeira ligação

Quando se coloca o aparelho em funcionamento pela primeira vez, é necessário retirar o ar do interior da máquina de café.

 Ligue o aparelho no interruptor principal situado na parte posterior do aparelho (Figura ).



Quando se liga o interruptor principal pela primeira vez, todos os símbolos no display acendem-se durante alguns segundos para realizar um auto-teste,



depois os símbolos  e  começam a piscar.



 Encher o depósito da água, ver „Colocar água“ página 147.



 Volte a colocar o depósito da água no aparelho (Figura 6). Pressione bem o depósito, para que a válvula do mesmo se abra.

 Rode o bocal de vapor para o lado exterior e coloque a chávena por baixo do bocal (Figura 9).

 Rodar o botão de vapor e água quente tanto quanto possível contra o sentido dos ponteiros do relógio para a posição  (Figura 10).

Sai um pouco de água do bocal de vapor. Os símbolos  e  estão acesos permanentemente.

Quando a chávena estiver cheia com cerca de 30 ml de água, os símbolos  e  começam a piscar.



 Rodar o botão de vapor e água quente tanto quanto possível no sentido dos ponteiros do relógio para a  posição (Figura 10), para parar o fluxo de água.

O símbolo  pisca durante alguns segundos e o aparelho desliga-se.



 Encher o recipiente de grãos de café, ver „Encher o recipiente dos grãos de café“ página 148.

### 5.5 Ligar o aparelho

Antes de ligar o aparelho, certifique-se de que existe água no depósito e, se necessário, encha até ao nível adequado. Sempre que o aparelho é ligado e desligado, este necessita de água para os ciclos de lavagem automáticos.

 Ligue o aparelho com o botão “Ligar/Desligar”  (Figura 11).

 Depois de premir o botão, o aparelho liga-se imediatamente. Os ruídos que se fazem sentir são perfeitamente normais.



 Durante o processo de aquecimento (aprox. 120 segundos), o símbolo  pisca.

Durante o aquecimento, o aparelho realiza uma lavagem automática (sai um pouco de água quente pela saída de café, que depois é apanhada no colector de gotas).

Quando o aquecimento termina, o símbolo  mantém-se aceso permanentemente.

Agora o aparelho está pronto a ser utilizado. Estão acesos os símbolos de acordo com o último modo de café seleccionado.

### 5.6 Desligar o aparelho.

-  Desligue o aparelho com o botão "Ligar/Desligar"  (Figura 11).

O símbolo  pisca. O programa executa um ciclo de limpeza e desliga-se.

-  Se o aparelho não for utilizado durante bastante tempo, por razões de poupança energética, ele desliga-se automaticamente passadas 3 horas.

-  Se o aparelho não for utilizado durante um período de tempo mais prolongado, depois de o desligar com o botão "Ligar/Desligar" deve ainda desligar o interruptor principal, na parte posterior do mesmo (Figura 8).

### 5.7 Definir a dureza da água

Após a primeira colocação em funcionamento ou ao utilizar uma qualidade de água diferente o aparelho deve ser definido para o grau de dureza da água, que corresponde à dureza da água local. Utilize a tira de teste fornecida para determinar o grau de dureza da água ou pergunte aos serviços municipalizados locais qual o grau de dureza.

#### Determinar o grau de dureza da água

-  Para isso, mergulhe a tira de teste durante ca. de 1 segundo em água fria. Retire a água em excesso e determine o grau de dureza de acordo com os campos tingidos de cor-de-rosa.



Nenhum ou um campo cor-de-rosa:

**Grau de dureza 1, macia**  
até 1,24 mmol/l ou  
até 7° dureza alemão ou  
até 12,6° dureza francesa

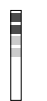

**Dois campos cor-de-rosa:**  
**Grau de dureza 2, média**  
até 2,5 mmol/l ou  
até 14° dureza alemão ou  
até 25,2° dureza francesa



**Três campos cor-de-rosa:**  
**Grau de dureza 3, dura**  
até 3,7 mmol/l ou  
até 21° dureza alemão ou  
até 37,8° dureza francesa

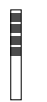





**Quatro campos cor-de-rosa:**  
**Grau de dureza 4, muito dura**  
mais de 3,7 mmol/l ou  
mais de 21° dureza alemão ou  
mais de 37,8° dureza francesa

#### Definir e memorizar o grau de dureza determinado da água





É possível definir 4 graus de dureza. O aparelho vem programado de fábrica com o grau de dureza 4.

-  Com o aparelho ligado, prima o botão "P" (Figura 4).

Os símbolos "P" e  acendem-se. Além disso acendem-se os pequenos 3 símbolos sobre as teclas ,  e , a fim de indicar o funcionamento momentâneo destas teclas, consulte o „Modo especial" página 147.

-  Confirme a selecção com o botão "OK" (Figura 5 5).

O display mostra a regulação actual. Os graus de dureza mostram-se da seguinte maneira:

-  Grau de dureza 1
-  Grau de dureza 2
-  Grau de dureza 3
-  Grau de dureza 4

-  Em seguida, prima os botões Folhear "<" ou ">" (Figura 5) tantas vezes até que apareça a indicação do nível de dureza da água determinado.

P

☞ Confirme a selecção com o botão "OK" (Figura 5). Este grau de dureza está agora armazenado.

**i** Para interromper sem armazenar, premir "P" em vez de "OK".  
Se não for premido o botão "OK", após aprox. 120 segundos, o aparelho volta automaticamente para o modo de café sem memorizar os dados.

☞ Para regressar ao modo de café prima, para finalizar, o botão "P" (Figura 4) ou aguarde aprox. 120 segundos até o aparelho regressar automaticamente ao modo de café.

## 6 Preparar café com grãos

Durante a preparação de café com grãos, o seguinte processo desenrola-se **automaticamente**: Moagem, dosagem, prensagem, pré-infusão, infusão e eliminação das borras.

Com a possibilidade de definição do grau e quantidade de moagem pode ajustar a máquina ao seu gosto pessoal.

**!** Certifique-se de que utiliza apenas grãos puros, sem adição de ingredientes caramelizados ou aromatizados e grãos congelados. Certifique-se de que não entram objectos estranhos para este recipiente como, por exemplo, pequenas pedras. **Se o mecanismo de moagem ficar bloqueado ou danificado devido a um objecto estranho, isto poderá eventualmente não estar coberto pela garantia.**



Consoante as preferências, seleccione um expresso "curto" ou um café "comprido" com creme.

☞ Com o botão "Tamanho de chávena" (Figura 12), seleccione o tamanho da chávena desejada. É indicado o tamanho da chávena seleccionada.

**i** Os tamanhos de chávena mostram-se da seguinte maneira:

 Chávena de café expresso

 Chávena pequena

 Chávena média  
 Chávena grande  
 Copo

Pode seleccionar o seu café com aroma extra-suave, suave, normal, forte ou extra-forte.

☞ Seleccione o aroma do café desejado com o botão "Aroma do café" (Figura 13). É indicado o aroma do café.

**i** A intensidade do café mostra-se da seguinte maneira:

 extra-suave



 suave



 normal



 forte



 extra-forte



☞ Coloque uma ou duas chávenas por baixo da saída do café (Figura 14). Fazendo deslizar a saída para cima ou para baixo, é possível ajustar a altura da saída de forma optimizada à altura da chávena reduzindo, assim, perda de calor e salpicos de café (Figura 15).



☞ Prima o botão "1 chávena de café"  para preparar uma chávena de café ou o botão "2 chávenas"  para 2 chávenas.

O símbolo "1 Chávena"  ou "2 Chávenas"  está aceso. Agora a máquina está a moer os grãos. Para a pré-infusão, durante a preparação do café, o café moído é humedecido com uma pequena porção de água. Após uma breve interrupção ocorre o verdadeiro processo de infusão. O café é servido para a chávena.



Quando tiver sido fornecida a quantidade de café desejada, o aparelho interrompe automaticamente essa entrega e deita o pó de café usado no depósito de borras. Durante este tempo, o símbolo "1 Chávena"  ou "2 Chávenas"  mantém-se a piscar.



 É possível, a qualquer altura, terminar antecipadamente de servir café premindo de forma breve o botão "1 chávena"  ou "2 chávenas"  ou se rodar o botão "Tamanho de chávena" (Figura 12) contra o sentido dos ponteiros do relógio, na direcção "Chávena de expresso".



 No momento em que a entrega de café tenha finalizado, pode aumentar a quantidade de café premindo e mantendo premida a tecla "1 Chávena"  ou "2 Chávenas" , até ter atingido a quantidade de café desejada, ou então rodando o manipulo "Tamanho da chávena" (Figura 12) no sentido dos ponteiros do relógio para "Copo" (isto tem de acontecer imediatamente depois de se ter tirado o café e antes do café moído usado ser deitado no depósito de borras).

Depois de alguns segundos, depois do símbolo "1 Chávena"  ou "2 Chávenas"  se ter apagado, o aparelho estará de novo operacional e poderá preparar o seguinte café.



 Quando o café não sair na totalidade, for servido às gotas ou se sair demasiado depressa e o creme não estiver do seu agrado, deve alterar as definições de moagem, ver „Regular moinho" página 155

 Se os símbolos  e  piscarem, isso significa que o café foi moído demasiado fino. Terá que alterar a regulação do grau de moagem, ver „Regular moinho" página 155.

 Quando o símbolo  se acender, terá que encher o depósito de água; caso contrário, a máquina não poderá preparar café. (É normal que quando este símbolo aparece, ainda haja alguma água no depósito).

 Quando o símbolo  estiver aceso, o depósito de borras está cheio e tem que ser esvaziado e limpo, ver „Esvaziar o depósito das borras" página 157. Enquanto não se limpar o depósito de

borras, o símbolo manter-se-á aceso e a máquina não poderá preparar café.

 Nunca retirar o depósito da água enquanto está a ser servido café. Caso este tenha sido retirado, a máquina deixa de poder preparar café. Para arejar a máquina rodar o botão de vapor e água quente tanto quanto possível contra o sentido dos ponteiros do relógio para a posição  e, durante alguns segundos, deixar sair água pelo bocal de vapor.

 Na primeira colocação em funcionamento deverá preparar pelo menos 4 a 5 cafés, antes da máquina ter um desempenho satisfatório.

### 6.1 Sugestões para servir café mais quente:

- Caso deseje preparar café para uma chávena pequena (menos de 60 ml), imediatamente após ter ligado a máquina, utilize a água quente do ciclo de lavagem para aquecer as chávenas.
- Defina uma temperatura de café mais elevada, ver „Regulação da temperatura do café" página 156.
- Não utilize chávenas com demasiada espessura, excepto se estas forem aquecidas, pois absorvem muito o calor.
- Para utilizar chávenas aquecidas, enxagúe as mesmas com água quente ou coloque-as pelo menos durante 20 minutos no tabuleiro de aquecimento de chávenas (H) da máquina de café ligada.

## 7 Preparar várias chávenas de café com a função de jarro

Esta função permite preparar automaticamente **várias chávenas de café no jarro térmico de aço inoxidável**: Moagem, dosagem, prensagem, pré-infusão, infusão e eliminação das borras conforme descrito no ponto anterior.

P

 Rode a tampa do jarro térmico de aço inoxidável para a posição de abertura (Figura 16) e retire a tampa. Enxagúe o jarro e a tampa.

 Coloque a tampa no jarro, na posição de abertura (Figura 17) e coloque-o por baixo da saída do café (D). A saída do café tem de estar completamente empurrado para cima, para que seja possível inserir o jarro térmico.

Um dos símbolos da função de jarro está aceso, dependendo de quantas chávenas se tinham seleccionado durante a última utilização da função de jarro. Para além disso, os símbolos Folhear "<" e ">" estão acesos.

A quantidade de chávenas que se enchem no jarro mostram-se da seguinte maneira:

 4 Chávenas



 6 Chávenas



 8 Chávenas

 10 Chávenas

 Certifique-se de que o depósito de água está cheio, de que há grãos de café suficientes no depósito de grãos de café e que o depósito de borras está vazio, para poder preparar uma série de cafés para o jarro.

 Quando quiser alterar a intensidade do café e a quantidade de enchimento para a função Jarro, utilize o manípulo "Tamanho da chávena" (Figura 12), ou o manípulo "Intensidade do café" (Figura 13), tal como se descreve no ponto „Preparar café com grãos" página 150.

 Selecciona eventualmente com as teclas Folhear "<" ou ">" o símbolo correspondente à quantidade de chávenas que devem ser preparadas para o jarro, por exemplo  para 8 chávenas.



 Prima o botão "Jarro"  (Figura 18). Durante a preparação de café, o símbolo do jarro acende-se intermitentemente para a quantidade de chávenas seleccionada.

Quando o processo de infusão tiver finalizado, todos os símbolos de jarro piscarão alternativamente, sendo que o símbolo correspondente ao número de chávenas seleccionado se acenderá o dobro do tempo que os restantes símbolos.

 Retire o jarro térmico e feche a tampa (Figura 19), para manter o café quente durante muito tempo.

O aparelho regressa automaticamente para o modo de Café.



 Se houver demasiado pouco grão de café no depósito ou demasiado pouca água no depósito de água para poder terminar a função desejada, ou se o depósito de borras estiver cheio, o aparelho interrompe o processo e o programa que corre nesse momento será interrompido. Depois de resolvido o problema, será necessário voltar a iniciar o programa. Neste caso é necessário ter em conta a quantidade de café que já se encontra no jarro, para que o mesmo não transborde.

 Se os símbolos  e  piscarem, isso significa que o café foi moído demasiado fino. Terá que alterar a regulação do grau de moagem, ver „Regular moinho" página 155.

## 8 Preparar café com café moído

Com esta função pode preparar café pré-moído, por exemplo **café descafeinado**.

 **Atenção!** Certifique-se e que não ficou café moído preso no compartimento. Também não podem entrar corpos estranhos para o compartimento. O compartimento de enchimento não se destina ao armazenamento, o café moído tem de seguir directamente para a unidade de infusão.

 Rode o botão "aroma de café / café pré-moído" (Figura 20) para a posição desejada  (para 1 chávena) ou  (para 2 chávenas), para seleccionar a



função para café pré-moido. Desta forma, o moinho é desactivado.

Acende-se um símbolo ☞ (para 1 chávena) ou ambos os símbolos ☞ ☞ (para 2 chávenas).

- ☞ Abra a tampa do compartimento do café moído e encha-o com o café recém-moído (Figura 21).

Utilize apenas a colher de medida fornecida com a máquina. Nunca coloque mais de 2 colheres de medida rasas, caso contrário a máquina não prepara café, o café é distribuído pela máquina, sujando a mesma ou o café é servido às gotas e os símbolos ☞ e ☞ piscam.

Não coloque café moído na máquina durante o processo de infusão. Colocar o café moído para a chávena seguinte apenas depois do processo de infusão estar concluído, quando a máquina está de novo pronta a utilizar. Nunca coloque o café moído na máquina com a mesma desligada, caso contrário este espalhar-se-ia no seu interior.

- ⚠ Utilize apenas café moído para máquinas de expresso automáticas. Não coloque grãos de café, produtos instantâneos solúveis ou liofilizados, bem como outros pós para bebidas instantâneas no compartimento. Cafés com uma moagem demasiado fina podem provocar entupimentos.

- i Se o compartimento de enchimento estiver entupido (devido a humidade no aparelho ou porque foram colocadas mais de 2 colheres de medida de café moído na máquina) utilize uma faca ou a extremidade de uma colher para empurrar o café para baixo (Figura 22). Em seguida, retirar a unidade de infusão e limpá-la em conjunto com a máquina de café de acordo com as instruções em „Limpar a unidade de infusão“ página 157.

- ☞ Feche a tampa.

- ☞ Selecione o tamanho de chávena desejado com o manípulo "Tamanho de chávena" (Figura 12), tal como se des-

creve no ponto „Preparar café com grãos“ página 150.

- ☞ Prima o botão "1 chávena de café" ☞ para preparar uma chávena de café ou o botão "2 chávenas" ☞☞ para 2 chávenas.

O café está a ser preparado.

- i Se se tiver seleccionado a função para café pré-moído 1 chávena e não se tiver enchido café moído no compartimento de café, depois de se ter premido a tecla ☞, os símbolos ☞ e ☞ começarão a acender-se intermitentemente. Se se tiver seleccionado a função para café pré-moído 2 chávenas e não se tiver enchido café moído no compartimento de café, depois de se ter premido a tecla ☞☞, os símbolos ☞☞ e ☞☞ começarão a acender-se intermitentemente.

- i Para, após a preparação do café, voltar para o modo de grãos de café, rode o botão "aroma de café/ café pré-moído" (Figura 20) para qualquer definição de aroma (é restabelecido o funcionamento do moinho).





## 9 Espuma de leite

O vapor pode ser utilizado para fazer espuma de leite e para aquecer líquidos. Uma vez que para a produção de vapor é necessária uma temperatura mais elevada do que para a preparação de café, a máquina de café dispõe de um modo de vapor adicional.

- i Para uma dose de cappuccino, encha uma chávena grande com 1/2 a 2/3 de expresso e, em seguida, adicione a espuma de leite.



- ⚠ **Atenção!** Com o bocal de vapor em funcionamento existe perigo de queimadura! A água quente ou o vapor de água quente que sai da máquina pode provocar queimaduras. Active o bocal de vapor apenas quando já estiver submerso no leite.

P

 Para preparar vapor prima o botão "Vapor"  (Figura 23).  
O símbolo  acende-se e o aparelho aquece. Durante o aquecimento, o símbolo  acende-se intermitentemente.

Quando o processo de aquecimento tiver acabado, o símbolo  mantém-se aceso permanentemente. O aparelho está preparado para fazer espuma de leite.

 Se a função de vapor não for utilizada durante períodos superiores a 2 minutos, a máquina regressa automaticamente para o modo de café.



 Para evitar que, durante o processo de produção da espuma, a água residual não se misture com o leite, deve escoar primeiro a água. Para este efeito, segure o recipiente de baixo do bocal de vapor e rode o botão de vapor e água quente (Figura 10) até se formar  vapor. Volte a rodar o selector para a posição .

 Deite leite magro e frio num copo, que caiba por baixo do bocal de vapor do aparelho.

 O leite deve estar muito frio. Também deve utilizar um recipiente frio, por exemplo um copo de aço inoxidável, e não o lavar previamente com água quente.



 Rode o bocal de vapor para fora e mantenha o copo por baixo do bocal, de forma que a abertura do mesmo esteja submergida (mas não muito profundamente) no leite (Figura 24).

 **Atenção!** Perigo de impurezas por resíduos de leite seco no bocal de vapor. Tenha atenção para não submergir demasiado o bocal no leite, para que a abertura de aspiração de ar, na extremidade superior do bocal, não fique coberta com leite. Se isso acontecer, é possível que um pouco de leite possa ser aspirado para dentro do bocal e causar impurezas aí.

 Rode o botão de vapor e água quente (Figura 10) para a posição . É produzida espuma de leite.

 Para obter uma espuma de leite mais cremosa, mova o recipiente lentamente de baixo para cima. Repita este processo até o leite ter, pelo menos, duplicado em volume.



 Recomenda-se que não seja utilizado vapor, sem interrupções, durante um período superior a 2 minutos.



 Para terminar o processo de elaboração de espuma, rode o botão de vapor e água quente (Figura 10) para a posição  e, em seguida, retire o recipiente.

 **Atenção!** Perigo de queimadura com salpicos de leite quente! Antes de retirar o recipiente com a espuma de leite, desligue o vapor.

 Saia do modo de vapor, pressionando o botão "Vapor" (Figura 23) ou aguarde aprox. 120 segundos até o aparelho regressar automaticamente ao modo de café.

O aparelho está de novo pronto para a preparação de café.

 Após o processo de elaboração de espuma de leite, permita sempre uma saída breve de água quente pelo bocal, rodando o botão de vapor e água quente (Figura 10) para a posição . Esta operação é necessária para que os resíduos de leite dentro do bocal não sequem e, conseqüentemente, não o entupam. Utilize um recipiente coletor adequado. Durante este processo, o símbolo  mantém-se aceso.

 Em seguida, coloque novamente o botão de vapor e água quente na posição . No display aparece o modo de café seleccionado da última vez.

## 9.1 Limpar o bocal de vapor

**Importante:** Por motivos de higiene recomenda-se que efectue o processo, decrito de seguida, sempre que seja preparada espuma de leite. Evita, assim, que resíduos de leite se depositem no interior do bocal de vapor.

- ☞ Rode o botão de vapor e água quente no sentido dos ponteiros do relógio, até encostar na posição ●. Aguarde alguns minutos, até o bocal de vapor ter arrefecido.
- ☞ Nessa altura, agarre o tubo oscilante pelo manipulo preto e abra depois o fecho de baioneta do bocal de vapor, com uma pequena rotação no sentido dos ponteiros do relógio. Retire o bocal de vapor para baixo (Figura 25).
- ☞ Retire a peça interior do bocal de vapor de cima do tubo oscilante.
- ☞ Limpe o bocal de vapor e a peça interior com água quente.
- ☞ Verifique se os orifícios marcados na Figura 26 não estão entupidos. Se necessário, perfurar com uma agulha e limpar.
- ☞ Volte a montar a peça interior, empurrando-a com cuidado para cima do tubo oscilante.
- ☞ Monte novamente o bocal de vapor, voltando a empurrá-lo e rodando-o contra o sentido dos ponteiros do relógio.

## 10 Preparação de água quente

A água quente pode ser utilizada para aquecer chávenas e para preparar bebidas quentes como, por exemplo, chá ou sopas instantâneas.

- ⚠ **Atenção!** Com o bocal de água quente em funcionamento existe perigo de queimadura! A água quente que sai da máquina pode provocar queimaduras. Coloque o bocal de água quente apenas em funcionamento se, por baixo do mesmo, se encontrar um recipiente.
- ☞ Coloque um recipiente por baixo do bocal de água quente.
- ☞ Rode o botão de vapor e água quente para a posição ☞ (Figura 10). Sai água quente, o símbolo ☞ está aceso.
- i** Recomenda-se que não seja servida água quente, sem interrupções, durante um período superior a 2 minutos.

- ☞ Depois de retirada água quente, volte a rodar o botão de vapor e água quente para a posição ● (Figura 10) e retire o recipiente.

## 11 Regular moinho

O grau de moagem do moinho vem predefinido de fábrica como médio. Caso o café seja servido com demasiada rapidez ou demasiada lentidão (às gotas), pode alterar o grau de moagem durante o processo de moagem.

- ⚠ **O grau de moagem só pode ser modificado durante o processo de moagem, isto é, o manipulo da regulação do grau de moagem (Figura 2, T e Figura 27) só poderá ser rodado enquanto o mecanismo de moagem estiver a moer grãos de café durante a preparação de um café. A alteração destas regulações com o moinho desactivado pode danificar a máquina de café.**

- ☞ Defina o grau de moagem com o botão para a regulação do moinho (Figura 2, T) (Figura 27).

- Quando o café sai às gotas ou quando não sai na totalidade (é possível que os símbolos ☞ e ⚠ pisquem), o botão tem de ser rodado uma posição no sentido dos ponteiros do relógio. Rode o botão em uma posição, respectivamente, até o café ser servido de forma satisfatória.
- Caso o café saia com demasiada rapidez e o creme não estiver do seu agrado, rode o botão uma posição contra o sentido dos ponteiros do relógio.

- i** Tenha atenção para não rodar demasiado o botão para a regulação do moinho, caso contrário, ao serem servidos 2 cafés, estes poderão sair às gotas.

- i** Todavia, o efeito destas alterações não será notado antes de serem preparados dois cafés.

















P

**Retirar corpos estranhos do moinho**

Copos estranhos no moinho como, por exemplo, pedras, podem danificar o mecanismo de moagem. Um corpo estranho no café causa um ruído uniforme. Caso ouça este ruído durante o processo de moagem, desligue imediatamente o aparelho e contacte o serviço de assistência técnica. Se o mecanismo de moagem ficar bloqueado ou danificado devido a um objecto estranho, isto poderá eventualmente não estar coberto pela garantia.

**12 Regulação da temperatura do café**

É possível escolher entre três níveis de temperatura. A definição de fábrica é "Temperatura alta". Esta pode ser alterada da seguinte forma:

-  Prima o botão "P" (Figura 4). Os símbolos "P" e  acendem-se. Além disso acendem-se os pequenos 3 símbolos sobre as teclas ,  e , a fim de indicar o funcionamento momentâneo destas teclas, consulte o „Modo especial" página 147.
-  Prima as teclas de Folhear "<" ou ">" (Figura 5) tantas vezes até o símbolo  se acender.
-  Confirme com o botão "OK" (Figura 5). O display mostra a regulação actual. As temperaturas mostram-se da seguinte maneira:
  -  Temperatura baixa
  -   Temperatura média
  -    Temperatura alta
-  Com os botões Folhear "<" ou ">" (Figura 5) seleccione, eventualmente, outra temperatura.
-  Quando aparecer a temperatura desejada, confirme-a com o botão "OK" (Figura 5). Deste modo, terá programado esta temperatura.
-  Para interromper sem armazenar, premir "P" em vez de "OK".

 Se não for premido o botão "OK", após aprox. 120 segundos, o aparelho volta automaticamente para o modo de café sem memorizar os dados.

 Para regressar ao modo de café prima, para finalizar, o botão "P" (Figura 4) ou aguarde aprox. 120 segundos até o aparelho regressar automaticamente ao modo de café.

**13 Limpeza e cuidados**

Para um funcionamento sem falhas e para uma qualidade constante do café, mantenha a máquina sempre limpa.

**13.1 Limpeza regular**

 **Atenção!** Desligue o aparelho antes de proceder à limpeza. Deixe o aparelho arrefecer.

 **Atenção!** Nunca coloque o aparelho ou as suas peças individuais na máquina de lavar loiça. Nunca mergulhe a máquina de café em água.

 **Atenção!** Nunca colocar água no recipiente dos grãos de café, pois irá danificar o mecanismo de moagem.

 Não utilize produtos que risquem ou sejam abrasivos ou corrosivos. Limpe o interior e exterior da caixa apenas com um pano húmido.

 Diariamente, retire o depósito da água (Figura 6) e deite fora a água residual. Enxagúe o depósito da água com água limpa. Utilize diariamente água fresca.

 Esvazie diariamente o depósito das borras ou, o mais tardar, quando tal for solicitado através de uma mensagem no display, ver „Esvaziar o depósito das borras" página 157.

 Esvazie regularmente o colector de gotas. O mais tardar quando o flutuador vermelho do colector de gotas (Figura 28) aparecer através da abertura da grelha de gotejamento.

 Limpe regularmente, pelo menos uma vez por semana, o depósito da água (N), o colector de gotas (O), a grelha de gotejamento (A) e o depósito das bor-

ras (Q) com água quente, um detergente suave e, eventualmente, um pincel.

- ☞ Após cada preparação de espuma de leite, retire o bocal de vapor e limpe muito bem os resíduos de leite, ver „Limpar o bocal de vapor“ página 154.
- ☞ Verifique se as aberturas de saída do café não estão entupidas. Para proceder à limpeza, pode retirar o café ressequido com uma agulha (Figura 29).

### 13.2 Esvaziar o depósito das borras

O aparelho conta o número dos cafés preparados. Depois de 14 (ou 7 pares) de cafés preparados, o símbolo ☒ acende-se para indicar que o depósito de borras está cheio e que deve ser esvaziado, bem como também limpo. Enquanto o depósito de borras não for limpo, a máquina não poderá preparar nenhum café.

- ☞ Para a limpeza, premir o respectivo botão de abertura para desbloquear e abrir a porta de serviço (Figura 30); o símbolo ☐ acende-se.
- ☞ Retirar o colector de gotas (Figura 31), esvaziá-lo e limpá-lo.
- ☞ Esvazie e limpe cuidadosamente o depósito das borras. Certifique-se de que todas os resíduos depositados no fundo são eliminados.

**Importante:** Sempre que retira o colector de gotas, o depósito das borras também deve ser esvaziado, mesmo se não estiver completamente cheio. Se este processo não for realizado, nas seguintes preparações de café o depósito das borras pode encher em demasia e as borras excessivas podem entupir a máquina de café.

- i** Quando tiver retirado o colecto de gotas, o símbolo ☒ acende-se intermitentemente.
- i** Se, por norma, utilizar diariamente o aparelho, limpe também o depósito todos os dias. Esvazie o depósito das borras sempre

com a máquina ligada. Apenas assim, a máquina reconhece o esvaziamento.

### 13.3 Limpar o moinho

Os resíduos de café podem ser eliminados com um pincel macio ou com um aspirador do recipiente dos grãos de café.

- ⚠ **Atenção!** Nunca colocar água no moinho, pois irá danificar o mecanismo de moagem.

- ☞ Desligue o aparelho com o botão Ligar/Desligar (Figura 11) e com o interruptor principal (Figura 8). Retire a ficha.

- ☞ Retire os restantes grãos de café (por exemplo com o aspirador e um tubo ou bocal para juntas).

- i** Caso o corpo estranho não se deixe retirar, queira contactar o serviço de assistência técnica. **Se o mecanismo de moagem ficar bloqueado e danificado devido a um objecto estranho, isto poderá eventualmente não estar coberto pela garantia.**

- ⚠ **Atenção!** Perigo de ferimento através do moinho em funcionamento. Nunca ligue o aparelho quando estiver a mexer no moinho. Isto pode provocar ferimentos graves. Retire obrigatoriamente a ficha.

- ☞ Com uma porção reduzida de grãos, verifique o funcionamento do moinho, preparando um café. Na primeira moagem ou após a limpeza, entrará menos café moído para a unidade de infusão, uma vez que o compartimento tem de ser preenchido. Isto pode influenciar o primeiro café.

### 13.4 Limpar a unidade de infusão

Recomendamos que limpe regularmente a unidade de infusão (de acordo com a frequência de utilização). Antes do aparelho deixar de ser utilizado durante um período de tempo mais alargado (por exemplo férias), é necessário esvaziar e limpar muito bem o depósito das borras e da água bem como a unidade de infusão.

P

Proceda como se segue:

















-  Desligar a máquina premindo o botão Ligar/Desligar (Figura 11) (não retirar a ficha) e aguardar até todos os símbolos estarem apagados!
-  Premindo o respectivo botão de abertura, desbloquear e abrir a porta de serviço (Figura 30).
-  Retirar e limpar o colector de gotas e o depósito das borras (Figura 31).
-  Pressionar ambos os botões de desbloqueio vermelhos da unidade de infusão lateralmente e contra o centro (Figura 32) e retirar a unidade de infusão.
-  **Atenção:** A unidade de infusão pode apenas ser retirada quando o aparelho tiver sido desligado com o botão Ligar/Desligar , na parte frontal do aparelho. O aparelho não deve ser separado da rede de alimentação. Se tentar retirar a unidade de infusão com a máquina de café ligada, esta pode sofrer sérios danos.
-  Limpar a unidade de infusão sem detergentes, com água corrente. **Nunca lave a unidade de infusão na máquina de lavar loiça.**
-  Limpar cuidadosamente o interior da máquina Raspando as crostas de café da máquina de café com uma espátula de madeira ou de plástico ou um objecto parecido, que não risque a superfície, (Figura 33) e, em seguida, aspirar todos os resíduos (Figura 34).
-  Para voltar a colocar a unidade de infusão (Figura 36, a) no suporte (Figura 36, b) empurrá-la bem como o pino (Figura 36, c). O pino tem de ser inserido no tubo (Figura 36, d) na parte inferior da unidade de infusão.
-  Pressione firmemente o botão PUSH (Figura 36, e), até a unidade de infusão encaixar audivelmente.
-  Certifique-se de que, depois de ter ouvido o estalido de encaixe, os botões vermelhos (Figura 36, f) saltaram para fora, caso contrário não é possível fechar a porta de serviço.

Figura 37: Ambos os botões vermelhos saltaram correctamente para fora.

Figura 38: Ambos os botões vermelhos não saltaram para fora.

-  Volte a colocar o colector de gotas juntamente com o depósito das borras no seu lugar.
  -  Feche a porta de serviço.
  -  Quando a unidade de infusão não está inserida correctamente, ou seja, quando não se fizer sentir o estalido de encaixe e os botões vermelhos não saltaram para fora, não é possível fechar a porta de serviço.
  -  Se for difícil inserir a unidade de infusão, esta tem de ser ajustada para a altura correcta (antes de ser inserida). Para esse efeito, é necessário pressionar fortemente a unidade de infusão em simultâneo de cima e de baixo, como apresentado na Figura 35.
  -  Se a dificuldade de encaixe persistir, feche a porta de serviço, retire a ficha do cabo de alimentação da tomada e volte a inseri-lo.
- Aguarde até todos os símbolos se apagarem, em seguida, abra a porta de serviço e volte a encaixar a unidade de infusão.

### 13.5 Realizar o programa de descalcificação

O programa de descalcificação permite uma descalcificação simples e eficaz do aparelho. Quando o respectivo símbolo  se acender, isto significa que deverá proceder à descalcificação do aparelho.



**Atenção:** Não utilizar de modo nenhum quaisquer produtos de descalcificação, que não sejam recomendados pela AEG/Electrolux. Se utilizar outros produtos de descalcificação, a AEG/Electrolux não assume responsabilidade por eventuais danos. Poderá encontrar líquido de descalcificação em lojas especializadas ou através da linha de assistência técnica AEG/Electrolux.

- i** O processo de descalcificação dura aprox. 45 minutos e não deve ser interrompido. Em caso de corte de corrente, será necessário tornar a iniciar o programa.
- ☞** Antes de iniciar o programa de descalcificação, limpe a unidade de infusão (ver „Limpar a unidade de infusão“ página 157).
- ☞** Prima o botão "P" (Figura 4). Os símbolos "P" e ☞ acendem-se. Além disso acendem-se os pequenos 3 símbolos sobre as teclas ☞, ☞ e ☞, a fim de indicar o funcionamento momentâneo destas teclas, consulte o „Modo especial“ página 147.
- ☞** Prima as teclas de Folhear "<" ou ">" (Figura 5) tantas vezes, até o símbolo ☞ se acender.
- ☞** Confirme com o botão "OK" (Figura 5). Os símbolos ☞ e ☞ piscam e "P" mantém-se aceso permanentemente.
- i** Para interromper o programa de descalcificação neste ponto, desligar o aparelho com a tecla "Ligar/Desligar" ⏻.
- ☞** Esvazie o depósito da água, encha-o com pelo menos 1 litro de água e adicione então o produto para descalcificação.
- ⚠** Atenção: Certifique-se de que eventuais salpicos do produto de descalcificação não entrem em contacto com superfícies sensíveis a ácidos, como o mármore, calcário e cerâmica.
- ☞** Colocar um recipiente com uma capacidade mínima de 1,5 litro por baixo do bocal de vapor (Figura 9)
- ☞** Rodar o botão de vapor e água quente para a posição ☞.
- O programa de descalcificação é iniciado e o líquido de descalcificação escorre pelo bocal de vapor. Os símbolos ☞, ☞ e "P" mantêm-se acesos permanentemente.
- O programa de descalcificação realiza, automaticamente, uma série de lavagens e pausas, para remover os depósitos de calcário do interior da máquina de café.
- Depois de cerca de 30 minutos, o depósito de água está vazio e os símbolos ☞ e ☞ piscam e "P" mantém-se aceso permanentemente.
- ☞** Voltar a colocar o botão de vapor e água quente na posição ●.
- O aparelho está agora preparado para um ciclo de lavagem com água limpa.
- ☞** Puxe o depósito da água para fora, encha-o com água limpa e torne a colocá-lo no seu lugar.
- ☞** Esvaziar o recipiente colocado por baixo do bocal de vapor e volte a colocá-lo por baixo do bocal.
- ☞** Rodar o botão de vapor e água quente para a posição ☞.
- É realizado um ciclo de lavagem com água limpa e a água da lavagem sai do bocal de vapor. Os símbolos ☞, ☞ e "P" mantêm-se acesos permanentemente.
- Depois de alguns minutos, o depósito de água está vazio e os símbolos ☞ e ☞ piscam e "P" mantém-se aceso permanentemente.
- ☞** Voltar a colocar o botão de vapor e água quente na posição ●.
- Mostram-se os símbolos correspondentes ao modo de café que se tinha seleccionado anteriormente e o símbolo ☞ mantém-se aceso permanentemente.
- ☞** Esvaziar o recipiente com a água de lavagem.
- ☞** Puxe o depósito da água para fora, encha-o com água limpa e torne a colocá-lo no seu lugar.
- O aparelho está de novo pronto a utilizar e encontra-se no modo de café seleccionado.
- i** Recomendamos que, após o processo de descalcificação, rejeite a primeira chávena de café.

P

## 14 Encomenda de acessórios

Para que possa desfrutar ao máximo deste aparelho e para evitar falhas prematuras, é muito importante que o aparelho seja regularmente limpo e descalcificado. O produto de descalcificação original também pode ser adquirido através dos nossos serviços.



Na Alemanha, contacte a nossa hotline para encomendas:

1801 - 20 30 60\*



(\*Tarifa local a partir da rede fixa da Deutsche Telekom)  
Segundas a Sextas das 18:00 às 18:00 horas

## 15 Como proceder quando o display exhibe a seguinte mensagem...

O símbolo  mantém-se aceso permanentemente

- O depósito de água está vazio ou mal colocado.
-  Encher e colocar o depósito da água de acordo com as instruções, ver „Colocar água” página 147.
- O depósito da água está sujo ou formaram-se crostas de calcário no mesmo.
-  Limpar ou descalcificar o depósito da água.

Os símbolos  e  piscam



- A máquina não pode preparar café.
-  Colocar um recipiente por baixo do bocal de vapor e rodar o botão de vapor e água quente contra o sentido dos ponteiros do relógio para a posição  (Figura 9).
- O café sai muito lentamente.
-  Rodar o botão da regulação do grau de moagem (Figura 12) em uma posição no sentido dos ponteiros do relógio, enquanto o mecanismo de moagem estiver a moer grãos durante a preparação de um café (ver „Regular moimho” página 155).

O símbolo  mantém-se aceso permanentemente

- O depósito das borras está cheio.
-  Esvazie o depósito das borras de acordo conforme descrito em „Esvaziar o depósito das borras” página 157 limpe e torne a colocá-lo correctamente no seu lugar.



O símbolo  pisca

- Após a limpeza, o depósito das borras não voltou a ser colocado.
-  Abrir a porta de serviço e colocar o depósito das borras.

Os símbolos  ou  e  piscam

- Após a selecção da função para café pré-moído não foi inserido café moído no compartimento de enchimento.
-  Inserir café moído conforme descrito em „Preparar café com café moído” página 152.

Todos os símbolos para a intensidade do café  e  piscam

- Não existem grãos de café no recipiente.
-  Encher depósito de grãos de café, ver „Encher o recipiente dos grãos de café” página 148.
- Se o moinho começar a fazer muito barulho, isso pode significar que uma pequena pedra, existente nos grãos de café, bloqueou o mesmo.
-  Contacte o serviço de assistência técnica. Se o mecanismo de moagem ficar bloqueado ou danificado devido a um objecto estranho, isto poderá eventualmente não estar coberto pela garantia.

O símbolo  mantém-se aceso permanentemente



- Esta mensagem indica que a máquina de café tem crostas de calcário.
-  O programa de descalcificação descrito no capítulo „Realizar o programa de descalcificação” página 158 tem de ser realizado tão breve quanto possível.





**O símbolo  mantém-se aceso permanentemente**

- A porta de serviço está aberta.
-  Fechar a porta de serviço. Caso a porta de serviço não se deixe fechar, certifique-se de que a unidade de infusão está correctamente encaixada (ver „Limpar a unidade de infusão“ página 157)



**O símbolo  pisca**

- Provavelmente, após a limpeza, esqueceu-se de voltar a colocar a unidade de infusão na máquina.
-  Encaixar a unidade de infusão, ver „Limpar a unidade de infusão“ página 157
- O interior da máquina tem muita sujidade.
-  Limpar cuidadosamente o interior da máquina, ver „Limpar a unidade de infusão“ página 157. Caso, após a limpeza, a máquina continuar a exibir a mensagem, contacte o serviço de assistência técnica.

**O símbolo  está aceso permanentemente**

- Isto indica um alarme geral.
-  Contacte por favor o nosso serviço de assistência técnica.

**Os símbolos  e  piscam**

- O aparelho foi ligado com o botão de vapor e água quente na posição "aberta" .
-  Rode o botão de vapor e água quente para a posição .

**Os símbolos  e  piscam**

- A temperatura ambiente é demasiado baixa para poder colocar o aparelho em funcionamento.
-  Faça funcionar o aparelho num lugar mais quente.



## 16 Problemas com solução, antes de contactar o serviço de assistência técnica

Se a máquina de café não funcionar, pode determinar facilmente a causa da falha de funcionamento e resolvê-la, consultando o capítulo „Como proceder quando o display exibe a seguinte mensagem...“ página 160. Se a máquina de café não indicar qualquer símbolo, realize as seguintes verificações, antes de contactar o serviço de assistência técnica.

**O café não está quente**

- As chávenas não foram aquecidas.
-  Aquecer as chávenas, enxaguando as mesmas com água quente ou colocando-as pelo menos durante 20 minutos no tabuleiro de aquecimento de chávenas (H) (ver „Sugestões para servir café mais quente.“ página 151).

**O café tem pouco creme**

- A moagem do café é muito grossa.
-  Rodar o botão da regulação do grau de moagem contra o sentido dos ponteiros do relógio, enquanto o mecanismo de moagem estiver a moer grãos de café durante uma preparação de café (ver „Regular moinho“ página 155).
- A mistura de café não é apropriada.
-  Utilizar uma mistura própria para máquinas de café automáticas.

**O café sai muito lentamente**

- A moagem do café é muito fina.
-  Rodar o botão da regulação do grau de moagem no sentido dos ponteiros do relógio, enquanto o mecanismo de moagem estiver a moer grãos de café durante uma preparação de café (ver „Regular moinho“ página 155).

P

**O café sai muito rapidamente**

- A moagem do café é muito grossa.

☞ Rodar o botão da regulação do grau de moagem contra o sentido dos ponteiros do relógio, enquanto o mecanismo de moagem estiver a moer grãos de café durante uma preparação de café (ver „Regular moinho“ página 155).

**O café sai apenas de uma das saídas de café**

- Os orifícios das saídas estão entupidos.

☞ Remover o café ressequido com uma agulha (Figura 29).

**Apesar da rotação do botão de vapor e água quente, não sai vapor do bocal do vapor**

- Os pequenos orifícios do bocal de vapor e da peça interior estão entupidos.

☞ Limpar os orifícios do bocal de vapor e da peça interior (ver „Limpar o bocal de vapor“ página 154).

**Quando está seleccionada a função ☞ ou ☞ não sai café da máquina, mas água**

- O café moído poderá ter ficado preso no compartimento de enchimento.

☞ Remover o café moído que está a entupir o compartimento de enchimento com a ajuda de uma faca (ver „Preparar café com café moído“ página 152) (Figura 22). Em seguida, limpar a unidade de infusão e o interior da máquina (ver „Limpar a unidade de infusão“ página 157).

**Ao premir o botão ① a máquina não se liga**

- O interruptor principal, na parte posterior do aparelho, não está ligado (Figura 8) ou a ficha não está ligada à tomada.

☞ Verifique se o interruptor principal se encontra na posição "I" e se a ficha está bem inserida na tomada.

**A unidade de infusão não se deixa retirar para os procedimentos de limpeza**

- A máquina de café está ligada. A unidade de infusão pode apenas ser retirada com a máquina desligada.

☞ Desligar a máquina e retirar a unidade de infusão (ver „Limpar a unidade de infusão“ página 157).

**i** **Atenção:** A unidade de infusão pode apenas ser retirada quando o aparelho tiver sido desligado com o botão Ligar/Desligar ①, na parte frontal do aparelho. O aparelho não deve ser separado da rede de alimentação. Se tentar retirar a unidade de infusão com a máquina de café ligada, esta pode sofrer sérios danos.

**O café não sai pelas saídas de café, mas na parte lateral, pela porta de serviço**

- As aberturas da saída de café estão entupidas com café ressequido.

☞ Remover o café ressequido com uma agulha (Figura 29).

- O compartimento oscilante que se situa na tampa de serviço (R) está bloqueado e não oscila.

☞ Limpar cuidadosamente o compartimento oscilante, em particular na proximidade das dobradiças, para que estas mantenham a mobilidade.

**Foi utilizado café moído (em vez de grãos) e não sai café da máquina.**

- Foi colocado demasiado café pré-moído na máquina.

☞ Retirar a unidade de infusão e limpar cuidadosamente o interior da máquina de acordo com as instruções em „Limpar a unidade de infusão“ página 157. Repetir o processo e utilizar no máximo 2 colheres de medida rasas de café moído.

- O botão "Aroma do café / café pré-moído" não foi colocado na posição ☞ ou ☞ e o aparelho utilizou café pré-moído bem como aquele moído pelo moinho.

- ☞ Limpar cuidadosamente o interior da máquina, como apresentado em „Limpar a unidade de infusão" página 157. Repetir o processo, colocando primeiro o botão "Aroma do café / café pré-moído" na posição correcta, conforme descrito em „Preparar café com café moído" página 152.
- O café pré-moído foi colocado na máquina com a mesma desligada.
- ☞ Retirar a unidade de infusão e limpar cuidadosamente o interior da máquina de acordo com as instruções em „Limpar a unidade de infusão" página 157. Repetir o processo com a máquina ligada.

#### Como proceder quando o aparelho for transportado?

- Guardar a embalagem original como protecção de transporte. Para proteger contra arranhões utilizar impreterivelmente o saco de plástico original.
- Proteger o aparelho e o jarro térmico contra choques. Não pode ser assumida responsabilidade por danos causados durante o transporte.
- Esvaziar o depósito da água e de borras.
- Tenha em atenção o local do aparelho, especialmente nas alturas frias do ano. Podem ocorrer danos provocados pelo frio.





## 17 Modo de estatística







O aparelho oferece a possibilidade de consultar os seguintes valores:

- número de todos os cafés preparados até ao momento com o aparelho,
- o número de todos os jarros com 4 chávenas, com 6 chávenas, 8 chávenas e 10 chávenas,
- o número de descalcificações realizadas, e, para além disso
- a quantidade de litros de água que foram entregues com a máquina.

**i** Quando se preparam 2 cafés ao mesmo tempo, estes também se contam como 2 chávenas.

Para ligar o modo de estatística, o aparelho deve estar desligado.





- ☞ Se necessário, desligue o aparelho com o botão "Ligar/Desligar"  (Figura 11).
  - ☞ Premir a tecla "P" (Figura 4) durante pelo menos 6 segundos.
- Os símbolos "P" e  acendem-se. Além disso acendem-se os pequenos 3 símbolos sobre as teclas ,  e , a fim de indicar o funcionamento momentâneo destas teclas, consulte o „Modo especial" página 147.
- ☞ Prima as teclas de Folhear "<" ou ">" (Figura 5) tantas vezes, até se acender o símbolo para o qual se deseja ver a estatística correspondente:

-  Número de cafés preparados
-  Número de descalcificações realizadas
-  Número de jarros preparados com 4 chávenas
-  Número de jarros preparados com 6 chávenas
-  Número de jarros preparados com 8 chávenas
-  Número de jarros preparados com 10 chávenas
-  Quantidade de litros de água entregues

Quando um símbolo estiver aceso, poderá mostrar o número correspondente da seguinte maneira:

- ☞ Premindo e mantendo premida a tecla "OK" (Figura 5).

Agora, as indicações vão piscando uma a seguir à outra, mostrando-se durante este tempo o valor consultado:





-  Piscar uma vez, corresponde a 1
-  Piscar uma vez, corresponde a 10
-  Piscar uma vez, corresponde a 100
-  Piscar uma vez, corresponde a 1,000
-  Piscar uma vez, corresponde a 10,000

P

O sinal de piscar repete-se continuamente enquanto se mantiver premida a tecla "OK". Antes de cada repetição existe uma pausa de 3 segundos.

 Conte número de piscadelas.

Exemplo: A seguinte sequência de piscadelas corresponde ao número 1.529.

-  Pisca 9 vezes
-  Pisca 2 vezes
-  Pisca 5 vezes
-  Pisca 1 vezes
-  Pisca 0 vezes

 Para sair do modo de estatística, premir a tecla "P" (Figura 4) durante pelo menos 6 segundos.

## 18 Dados técnicos

Tensão de rede: 220-240 V  
Consumo de energia: 1350 W

 Este aparelho está em conformidade com as seguintes directivas da CE:

- 73/23/CEE de 19.2.1973 "Directiva de baixa tensão", inclusive a modificação 93/68/CEE.
- 89/336/CEE de 03.05.89 "Directiva de baixa tensão", inclusive a modificação 92/31/CEE.

## 19 Eliminação



### Material de embalagem

Os materiais utilizados na embalagem deste aparelho são recicláveis e compatíveis com o ambiente. As peças em plástico estão identificadas, por exemplo, >PE<, >PS< etc. Elimine os materiais de embalagem de acordo com a sua identificação, utilizando para o efeito os contentores de recolha existentes para essa finalidade nos locais de eliminação de resíduos da sua área de residência.



### Aparelho usado

O símbolo  no produto ou na embalagem indica que este produto não pode ser tratado como lixo doméstico. Em vez disso, deve ser entregue ao centro de recolha selectiva para a reciclagem de equipamento eléctrico e electrónico. Ao garantir uma eliminação adequada deste produto, irá ajudar a evitar eventuais consequências negativas para o meio ambiente e para a saúde pública. A eliminação incorrecta coloca em risco o meio ambiente e a saúde. Para obter informações mais pormenorizadas sobre a reciclagem deste produto, contacte os serviços municipalizados locais, o centro de recolha selectiva da sua área de residência ou o estabelecimento onde adquiriu o produto.

## 20 Em caso de assistência

Guardar impreterivelmente a embalagem original, inclusive as peças de esferovite. Para evitar danos de transporte, o aparelho tem de ser acondicionado de forma segura.

Quando enviar o aparelho, junte sempre o jarro de conservação em quente. Este jarro é necessário para efectuar testes no aparelho.

**S Bästa kund,**

läs noga igenom denna bruksanvisning. Beakta särskilt säkerhetsanvisningarna! Ta väl vara på bruksanvisningen för senare uppslagning och lämna ut den om en annan person övertar kaffebryggaren.

**Innehållsförteckning**

<b>1 Bildförklaring</b>	<b>166</b>	<b>10 Hetvattenberedning</b>	<b>175</b>
1.1 Framvy (bild 1)	166	<b>11 Inställning av malningsgrad</b>	<b>176</b>
1.2 Framvy med öppen servicelucka (bild 2)	166	<b>12 Inställning av kaffetemperaturen</b>	<b>176</b>
1.3 Reglagepanel (bild 3)	166	<b>13 Rengöring och skötsel</b>	<b>177</b>
<b>2 Kaffe och espresso</b>	<b>167</b>	13.1 Regelbunden rengöring	177
<b>3 Säkerhetsanvisningar</b>	<b>167</b>	13.2 Tömning av sumpbehållaren	177
<b>4 Specialmod</b>	<b>169</b>	13.3 Rengöring av kvarn	177
<b>5 Första start av bryggaren</b>	<b>169</b>	13.4 Rengöring av bryggningsenhet	178
5.1 Uppställning och anslutning av bryggaren	169	13.5 Avkalkning	179
5.2 Påfyllning av vatten	169	<b>14 Beställning av tillbehör</b>	<b>180</b>
5.3 Påfyllning av kaffebönsbehållaren	169	<b>15 Vad göra om på displayen följande meddelande visas...</b>	<b>180</b>
5.4 Första inkoppling	170	<b>16 Problem som kan lösas innan kundtjänsten rings upp</b>	<b>181</b>
5.5 Påkoppling av bryggaren	170	<b>17 Statistikmod</b>	<b>182</b>
5.6 Frånkoppling av bryggaren	170	<b>18 Tekniska data</b>	<b>183</b>
5.7 Inställning av vattnets hårdhet	170	<b>19 Avfallshantering</b>	<b>184</b>
<b>6 Kaffebrygning med bönor</b>	<b>171</b>	<b>20 Om service behövs</b>	<b>184</b>
6.1 Tips för tappning av hetare kaffe	172		
<b>7 Brygning av flera koppar kaffe med kannfunktionen</b>	<b>173</b>		
<b>8 Kaffebrygning med pulver</b>	<b>173</b>		
<b>9 Uppskumning av mjölk</b>	<b>174</b>		
9.1 Renföring av ångmunstycket	175		

S

## 1 Bildförklaring

### 1.1 Framvy (bild 1)

- A Droppgaller
- B Varmhållningskanna
- C Huvudströmställare (på bryggarens baksida)
- D I höjd inställbart kaffeutlopp
- E Reglagepanel (se bild 3)
- F Lock för kaffebönbehållare
- G Lock för kaffepulverkanal
- H Uppvärmad ställplats för koppar
- J Svängör för ånga och hett vatten
- K Ångmunstycke (avtagbart)
- K Ångmunstycke (avtagbart)
- M Öppningsknapp för servicelucka
- N Vattentank med max-märke (avtagbar)
- O Droppskål med flottör ((avtagbar)

### 1.2 Framvy med öppen servicelucka (bild 2)

- P Servicelucka (öppen)
- Q Kaffesumpbehållare (uttagbar)
- R Utsvängningsfack
- S Bryggningseenhet
- T Knapp för inställning av malningsgrad
- U Kaffebönsbehållare
- V Mätsked
- W Påfyllningskanal för förmalet kaffepulver
- X Typskylt (apparatens undersida)
- Y Flytande avkalkningsmedel
- Z Testremsa

### 1.3 Reglagepanel (bild 3)

- a Ratt "Kaffestyrka / förmalet kaffe"
- b Ratt "Koppstorlek"
- c Display
- d Knapp "1 kopp kaffe" ☐  
I specialmoden används knappen för "Bläddring" ("<")
- e Knapp "2 koppar kaffe" ☐  
I specialmoden används knappen för "Bläddring" (">")
- f Knapp "Ånga" ☁  
Knapp "Ånga" i specialmoden bekräftar denna knapp menypunkten ("OK")
- g Knapp „P“  
I specialmoden går man med denna knapp tillbaka till senaste nivå utan ändringar ("P")
- h Knapp "Till/Från" ⓪
- j Ratt för ånga och hett vatten
- k Knapp "Kannfunktion" ☐
- l Symboler "Förmalet kaffe"
- m Symboler "Kanna"
- n Symboler "Kaffestyrka"
- o Symboler "Koppstorlek"
- p Symbol "Vattentank tom" ☐
- q Symbol "Avkalkning" ☐
- r Symbol "Bryggarens temperatur" ↓
- s Symbol "Servicedörren öppen" ☐
- t Symbol "Sumpbehållare" ☐
- u Symbol "Observera" ▲
- v Symbol "Hetvatten" ☐
- w Symbol "Ånga" ☁
- x Symbol "Bryggning av 2 koppar" ☐
- y Symbol "Bryggning av 1 kopp" ☐
- z Symbole för specialmoden

## 2 Kaffe och espresso

Den helautomatiska bryggarens funktion garanterar mycket lätt **hantering**, vid kaffebrygning och lika enkel att sköta och vårda.

En utsökt, individuell **smak** uppnås genom

- förbrygningssystemet: före den egentliga brygningen fuktas kaffepulvret för att utvinna hela aromen,
- den individuellt inställbara vattmängden per kopp för kort espresso och „långt“ kaffe Crema,
- den individuellt inställbara kaffetemperaturen för brygning av kaffet,
- du kan välja mellan normalt och starkt kaffe,
- malningsgraden kan ställas in i relation till kaffets rostning,
- och inte minst genom garanterad Crema, den speciella skumkronan som gör espresson så enastående för finmakaren.

**För övrigt:** Vid brygning av espresso står kaffepulvret under en betydligt kortare tid i kontakt med vattnet än vid brygning av vanligt filterkaffe. Detta resulterar i att mindre mängder bittra ämnen löses ur kaffepulvret vilket gör espresson mycket hälsosammare!

## 3 Säkerhetsanvisningar



Bryggarens säkerhet uppfyller godkända regler för teknik och apparatsäkerhetslagens föreskrifter. Det oaktat ber vi er att göra er förtrogen med säkerhetsanvisningarna nedan.

### Allmän säkerhet

- Bryggaren får endast anslutas till elnät vars spänning, strömtyper och frekvens överensstämmer med uppgifterna på typskylten (se bryggarens undre sida)!
- Låt aldrig nätsladden beröra heta delar på bryggaren.
- Dra aldrig med nätsladden ut stickproppen ur vägguttaget!
- Bryggaren får inte tas i bruk om:
  - nätsladden är skadad eller
  - bryggarens hus har synliga skador.
- Anslut nätsladden till vägguttaget endast vid frånkopplad bryggare.
- Bryggaren får inte hanteras av personer (inklusive barn) som saknar nödvändig erfarenhet och kunskap för säker hantering eller av personer (inklusive barn) som är fysiskt, eller psykiskt handikappade om de inte blivit undervisade eller instruerade av en person som ansvarar för deras säkerhet.

### Skydda barn

- Lämna inte påkopplad bryggare utan uppsikt och var speciellt försiktig om barn finns i närheten!
- Förpackningsmaterial som t.ex. plastpåsar får inte hamna i barnens händer.

### Säkerhet under brygning

- **Obs!** Kaffeutloppet, ångmunstycket och ställplatsen för koppar blir under brygning heta. Håll barn på betryggande avstånd!
- **Obs!** Skållningsrisk vid påkopplat ångmunstycke! Risk finns för att hett vatten eller het ånga leder till skållning. Koppla endast på ångmunstycket när ett kärl hålls under munstycket.
- Värm inte upp flambara vätskor med ånga!

S

- Använd bryggaren endast om vatten fyllts på! Håll endast kallt vatten i vattentanken, **men inte hett vatten, mjölk eller andra vätskor.** Beakta max. volym på ca 1,8 liter.
- Fyll inte på djupfrysta eller karamelliserade kaffeböner i bönbehållaren, utan endast rostade kaffeböner! Rensa kaffebönorna från främmande partiklar som t.ex. små stenar. Om kvarnen blockeras eller skadas av främmande partiklar kan vi frita oss från allt ansvar.
- Kaffepulvret skall fyllas på i pulverkanalen.
- Håll inte bryggaren påkopplad längre än nödvändigt.
- Utsätt inte bryggaren för väder och vind.
- Som förlängningssladd får endast en i handeln förekommande sladd med en ledningsarea på minst 1,5 mm<sup>2</sup> användas.
- För att undvika faror bör personer med motoriska störningar inte använda bryggaren utan assistans av en annan person.
- Bryggaren får endast användas med insatt droppskål, sumpbehållare och droppgaller!

### Säkerhet vid rengöring och skötsel

- Beakta rengörings- och avkalkningsanvisningarna.
- Före underhåll och rengöring skall bryggaren kopplas från och stickproppen dras ur!
- Doppa inte bryggaren i vatten.
- Ångmunstycket får rengöras endast när bryggaren är frånkopplad, kall och utan tryck!
- Bryggarens delar får inte rengöras i diskmaskin.
- **Håll aldrig vatten i kvarnen, risk för att kvarnen skadas.**

Bryggaren får varken öppnas eller repareras. Osakkunnig reparation kan leda till stora risker för användaren. Elapparater får endast repareras av elfackman.



För eventuell reparation samt byte av nätsladden bör du kontakta



- återförsäljaren där du köpte bryggaren eller
- AEG/Electrolux serviceline.

Om kaffebryggaren används för ändamål den inte är avsedd för eller om den används på fel sätt fritar vi oss från allt ansvar för skador och garanti - detta gäller även om avkalkning inte utförts omedelbart efter det symbolen  dyker upp och enligt instruktionerna i denna bruksanvisning. Om kvarnen blockeras eller skadas av främmande partiklar kan vi frita oss från allt ansvar.



## 4 Specialmod

För inställning av vattnets hårdhet („Inställning av vattnets hårdhet“ Sida 170) och kaffets temperatur („Inställning av kaffetemperaturen“ Sida 176), för start av avkalkningsprogrammet („Avkalkning“ Sida 179) och för statistisk kontroll („Statistikmod“ Sida 182) kan med knappen "P" (bild 4) kopplas om till specialmod. I specialmod används knapparna "1 kopp kaffe" , "2 koppar kaffe" , "Ånga"  och "P" för manövrering. Aktuell funktion visas på displayen ovanför knappen (bild 5):

- «<» ("1 kopp kaffe" ) och «>» ("2 koppar kaffe" ) medger „bläddring“
- «OK» ("Ånga" ) bekräftar en punkt
- «P» ("P") återgår till senaste nivå utan ändring

## 5 Första start av bryggaren

### 5.1 Uppställning och anslutning av bryggaren

Välj ett lämpligt, vågrätt, stabilt, ouppvärt, torrt och vattentåligt underlag.



Kontrollera att ordentlig luftcirkulation finns. På bryggarens sidor och baksida måste ett fritt utrymme på minst 5 cm och ovanför bryggaren på minst 20 cm finnas.

Bryggaren får inte ställas upp i rum där en temperatur på 0°C eller lägre kan förekomma (bryggaren skadas när vattnet fryser).



Obs! Om bryggaren tas in kall för uppställning i ett varmt rum, koppla på den först efter ca 2 timmar!

Vi rekommenderar att lägga ett lämpligt underlag in under bryggaren för att skydda omgivande parti mot skador till följd av stänk.



Kaffebryggaren skall anslutas till ett nätuttag med jorddon. Använd aldrig ett nätuttag utan jorddon.

### 5.2 Påfyllning av vatten

Kontrollera före påkoppling att vatten finns i vattentanken och fyll vid behov på. Bryggaren använder vatten vid varje in- och frånkoppling för automatisk sköljning.



Ta ut vattentanken ur bryggaren (bild 6). Sväng alltid ångmunstycket mitt för bryggaren innan vattentanken tas ut, i annat fall kan tanken inte tas bort.



Fyll vattentanken med rent och kallt vatten. Tanken får inte fyllas på utöver MAX-märket.



Fyll endast på kallt vatten. Andra vätskor som t.ex. mineralvatten eller mjölk får inte användas.



Sätt åter in vattentanken (bild 6). Tryck kraftigt in vattentanken så att dess ventil öppnar.



För ett aromatiskt kaffe, gör så här:

- byt dagligen vattnet i vattentanken,
- rengör vattentanken minst en gång i veckan i vanligt diskvatten (inte i diskmaskin). Skölj sedan med rent vatten.

### 5.3 Påfyllning av kaffebönsbehållaren



Fäll upp kaffebönsbehållarens lock och fyll på färska kaffeböner (bild 7). Sätt åter på locket.





**Observera!** Fyll inte på djupfrysta eller karamelliserade kaffeböner i bönsbehållaren, utan endast rostade kaffeböner! Kontrollera att inga främmande partiklar som t.ex. små stenar hamnar i bönsbehållaren. **Om kvarnen blockeras eller skadas av främmande partiklar kan vi frita oss från allt ansvar.**



Kvarnen har vid fabriken ställts in på medelhög malningsgrad. Om så behövs kan denna inställning ändras. Anvisningar för ändring av malningsgraden lämnas under „Inställning av malningsgrad“ Sida 176.

S



 **Malningsgraden får endast ändras under malning. Vid inställning på fränkopplad kvarn kan kaffebryggaren skadas.**

 Kaffebryggaren har vid fabriken kontrollerats. För testning har kaffe använts – därför är det helt normalt att kafferester sitter kvar i kvarnen. Vi garanterar dock att kaffebryggaren endast använts för testning.

#### 5.4 Första inkoppling

När kaffebryggaren första gången tas i bruk måste den avluftas



 Koppla på bryggaren med huvudströmställaren på baksidan (bild 8).



När huvudströmställaren första gången slås på, lyser alla symboler på displayen ett par sekunder för självttest, därefter blinkar symbolerna  och .



 Påfyllning av vattentank, se „Påfyllning av vatten“ Sida 169.



 Sätt åter in vattentanken (bild 6). Tryck kraftigt in vattentanken så att dess ventil öppnar.

 Sväng ångmunstycket utåt och ställ en kopp under (bild 9).

 Vrid ratten för ånga och hett vatten moturs så långt det går till läget  (bild 10).

Lite vatten rinner ur ångmunstycket. Symbolerna  och  lyser med fast ljus.

När koppen är fylld med ca 30 ml vatten, börjar symbolerna  och  blinka.



 Vrid ratten för ånga och hett vatten moturs så långt det går till läget  (bild 10) för avstängning av vattenflödet.

Symbolen  blinkar några sekunder varefter kaffebryggaren kopplar från.

 Fyll på kaffeböner i kaffebönsbehållaren, se „Påfyllning av kaffebönsbehållaren“ Sida 169.

#### 5.5 Påkoppling av bryggaren

Kontrollera före påkoppling att vatten finns i vattentanken och fyll vid behov på. Bryggaren använder vatten vid varje in- och fränkoppling för automatisk sköljning.

 Koppla på bryggaren med knappen „Till/Från“  (bild 11).

 Genast efter påkoppling ställer kaffebryggaren in sig. Härvid uppstår ljud som inte har någon betydelse.



 Under uppvärmning (ca 120 sekunder) blinkar symbolen .

Under uppvärmning sköljs kaffebryggaren automatiskt (lite vatten rinner ur kaffeutloppet ned i droppskålen).

Efter avslutad uppvärmning lyser symbolen  med fast ljus.

Kaffebryggaren är nu klar för användning. Nu lyser symbolerna för senast vald bryggningsfunktion.

#### 5.6 Fränkoppling av bryggaren

 Koppla från bryggaren med knappen „Till/Från“  (bild 11).

Symbolen  blinkar. Bryggaren utför sköljning och kopplas från.

 Om den påkopplade kaffebryggaren inte används under 3 timmar kopplas den automatiskt från.

 Om bryggaren under en längre tid inte ska användas bör efter fränkoppling med knappen „Till/Från“ dessutom huvudströmställaren på bryggarens baksida slås ifrån (fig. 8).

#### 5.7 Inställning av vattnets hårdhet

Innan bryggaren första gången tas i bruk eller om vattenkvaliteten ändrar sig skall bryggaren ställas in att motsvara hårdheten i aktuellt vatten.

Använd bifogad testremsa för bestämning av hårdhetsgraden eller fråga lokalt vattenverk.

##### Bestämning av vattnets hårdhet

 Doppa testremsan för ca 1 sekund i kallt vatten. Skaka av överflödigt vat-

ten och bestäm hårdheten med hjälp av fälten i rosa färg.

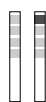

Inget eller ett rosa fält:

**Hårdhetsgrad 1, mjukt**  
till 1,24 mmol/l, resp.  
till 7° tysk hårdhetsgrad resp.  
till 12,6° fransk hårdhetsgrad

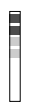

Två rosa fält:

**Hårdhetsgrad 2, medelhårt**  
till 2,5 mmol/l, resp.  
till 14° tysk hårdhetsgrad resp.  
till 25,2° fransk hårdhetsgrad



Tre rosa fält:

**Hårdhetsgrad 3, hårt**  
till 3,7 mmol/l, resp.  
till 21° tysk hårdhetsgrad resp.  
till 37,8° fransk hårdhetsgrad

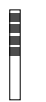

Fyra rosa fält:

**Hårdhetsgrad 4, mycket hårt**  
över 3,7 mmol/l, resp.  
över 21° tysk hårdhetsgrad, resp.  
över 37,8° fransk hårdhetsgrad

#### Inställning och lagring av vattnets beräknade hårdhetsgrad

4 hårdhetsgrader kan ställas in. Bryggaren har vid fabriken ställts in på hårdhetsgrad 4.

- Tryck vid påkopplad bryggare på knappen „P“ (bild 4).

Symbolerna "P" och ☰ lyser. Dessutom lyser de 3 små symbolerna ovanför knapparna ☐, ☐ och ☐, för att visa knapparnas aktuella funktion, se „Specialmod“ Sida 169.

- Bekräfta valet med knappen „OK“ (bild 5).

På displayen visas aktuell inställning. Hårdhetsgraderna visas enligt följande:



Hårdhetsgrad 1



Hårdhetsgrad 2



Hårdhetsgrad 3



Hårdhetsgrad 4

- Tryck sedan på knappen bläddra "<" eller ">" (bild 5) tills beräknad hårdhetsgrad visas.

- Bekräfta valet med knappen „OK“ (bild 5). Denna hårdhetsgrad har nu sparats.



För att avbryta utan att spara, tryck på "P" i stället för "OK".

Om „OK“ inte trycks återgår bryggaren efter ca 120 sekunder automatiskt till brygningsfunktion utan att spara inmatningarna.

- För att gå tillbaka till brygningsfunktionen tryck på knappen „P“ (bild 4) eller vänta ca 120 sekunder tills bryggaren automatiskt återgår till brygningsfunktionen.

## 6 Kaffebrygning med bönor

Följande process avlöper vid kaffebrygning med bönor **helautomatiskt**: Malning, dosering, pressning, förbrygning, brygning och utmatning av kaffesumpen.

Genom inställning av malningsgrad och malningsmängd kan kaffebrygningen anpassas individuellt till personlig smak.



Fyll inte på djupfrysta eller karamelliserade kaffebönor i bönbehållaren, utan endast rostade kaffebönor! Kontrollera att inga främmande partiklar som t.ex. små stenar hamnar i bönbehållaren. **Om kvarnen blockerar eller skadas av främmande partiklar kan vi frita oss från allt ansvar.**

Välj alltefter smak en „kort“ espresso eller ett „långt“ kaffe med Crema.

- Välj önskad koppstorlek med ratten „Koppstorlek“ (bild 12). Vald koppstorlek visas.



Koppstorleken visas enligt följande:



Espressokopp



liten kopp



medelstor kopp



stor kopp



Mugg

S

Kaffet kan väljas med extramild, mild, normalstark, stark eller extrastark smak.

☞ Välj önskad kaffesmak med ratten „Kaffestyrka“ (bild 13). Vald kaffesmak visas.

❗ Kaffets styrka visas så här:

- ☉ extramild
- ☉☉ mild
- ☉☉☉ normal
- ☉☉☉☉ starkt
- ☉☉☉☉☉ extrastark

☞ Ställ upp en eller två koppar under kaffeutloppet (bild 14). Utloppet kan skjutas uppåt eller nedåt för anpassning till koppens höjd för att reducera värmeförlust och kaffestänk (bild 15).

☞ Tryck knappen "1 kopp kaffe" ☐ för bryggning av en kopp eller knappen „2 koppar“ ☐ för 2 koppar. Symbolen "1 kopp" ☐ eller "2 koppar" ☐ lyser. Nu malas bönorna. Vid kaffe-bryggningen fuktas kaffepulvret för förbryggning med en liten mängd vatten. Efter ett kort avbrott startar själva bryggningen. Kaffet rinner ut i koppen. När önskad kaffemängd runnit ut, avslutar bryggaren automatiskt tappningen och förbrukat kaffepulver kastas ut i sumpbehållaren. Under denna tid blinkar symbolen "1 kopp" ☐ resp. "2 koppar" ☐.

☞ Kaffebryggningen kan när som helst avbrytas med kort tryckning på knappen "1 kopp" ☐ eller "2 koppar" ☐ eller genom att vrida ratten „Koppstorlek“ (bild 12) moturs i riktning mot „Espressokopp“.

☞ Efter avslutad kaffetappning, kan kaffemängden ökas genom att trycka ned knappen "1 kopp" ☐ eller "2 koppar" ☐ och hålla den nedtryckt tills önskad kaffemängd uppnåtts eller genom att vrida ratten "Koppstorlek" (bild 12) medurs mot "Mugg" (detta bör ske genast efter det kaffet tappats och innan det förbrukade kaffepulvret kastas ut i sumpbehållaren).

Efter ett par sekunder när symbolen "1 kopp" ☐ eller "2 koppar" ☐ slocknat, är kaffebryggaren åter klar för användning och kaffe kan åter bryggas.

❗ Om kaffet rinner ut i droppar, inte fullständigt eller för snabbt och Creman inte är i din smak skall inställningen av malningsgrad ändras, se „Inställning av malningsgrad“ Sida 176

❗ När symbolerna ☐ och ☐ blinkar, är kaffepulvret för finmalet. Ändra malningsgradens inställning, se „Inställning av malningsgrad“ Sida 176.

❗ När symbolen ☐ lyser, måste vattentanken fyllas på för att bryggaren skall kunna brygga kaffe. (Det är helt normalt att en mindre mängd vatten finns kvar i tanken när symbolen visas.)

❗ När symbolen ☐ lyser är sumpbehållaren full och måste tömmas och rengöras, se „Tömning av sumpbehållaren“ Sida 177. Så länge sumpbehållaren inte rengjorts, lyser symbolen och kaffe kan inte bryggas.

❗ Under kaffetappning får vattentanken absolut inte tas ut. Har tanken tagits ut kan kaffebryggaren inte längre brygga kaffe. För ventilation av kaffebryggaren vrid ratten för ånga och hett vatten så långt det går moturs till läget ☐ och låt vatten några sekunder rinna ur ångmunstycket.

❗ Vid första start av kaffebryggaren bör minst 4-5 koppar bryggas innan bryggaren ger ett bra resultat.

### 6.1 Tips för tappning av hetare kaffe:

- Om genast efter påkoppling av kaffebryggaren en liten kopp kaffe skall bryggas (under 60 ml), använd det heta sköljningsvattnet för uppvärmning av koppen.
- För inställning av en högre kaffetemperatur, se „Inställning av kaffetemperaturen“ Sida 176.

- När koppar i tjock kvalitet används bör de helst förvärmas, då materialet absorberar värme.
- Kopporna kan förvärmas med varmt vatten eller om de får stå minst 20 minuter på den uppvärmda ställplatsen (H) när kaffebyggaren är påkopplad.

## 7 Bryggning av flera koppar kaffe med kannfunktionen

Med denna funktion kan automatiskt flera koppar kaffe bryggas direkt i medföljande varmhållningskanna i rostfritt stål : Malning, dosering, pressning, förbryggning, bryggning och utmatning av kaffesumpen enligt beskrivning i föregående avsnitt.

 Vrid locket på medlevererad varmhållningskanna i rostfritt stål till läget för borttagning (fig 16) och lyft bort locket. Skölj kannan och locket.

 Ställ locket på varmhållningskannan i läge för upphållning (bild 17) och ställ kannan under kaffeutloppet (D). Kaffeutloppet måste vara helt uppskjutet för att varmhållningskannan skall kunna sättas in.

Symbolen för den kannfunktion lyser som senast använts för bryggning i kannan. Dessutom lyser symbolerna bläddra "<" och ">".

Antalet koppar som skall tappas i kannan visas så här:

 4 koppar

 6 koppar



 8 koppar



 10 koppar

 Kontrollera innan kaffebyggningen påbörjas att vattentanken är full, att tillräckligt mycket kaffeböner finns i bönbehållaren och att sumpbehållaren är tömd.

 Om kaffets styrka och påfyllningsmängden för bryggning i kannan skall ändras, använd ratten "Koppstorlek" (bild 12) resp. ratten "Kaffestyrka"

(bild 13) enligt beskrivning i avsnittet „Kaffebyggning med böner“ Sida 171.

 Välj med knapparna bläddra "<" eller ">" symbolen som motsvarar antalet koppar som skall bryggas i kannan, t.ex.  för 8 koppar.

 Tryck på knappen "Kanna"  (bild 18).



Under kaffebyggningen blinkar kannsymbolen för valt antal koppar.

När bryggningen är avslutad, blinkar alla kannsymbolerna turvis varvid symbolen för valt antal koppar lyser dubbelt så länge som de övriga symbolerna.

 Ta nu bort varmhållningskannan och stäng locket (fig 19) för att hålla kaffet varmt.

Bryggaren går automatiskt tillbaka till kaffefunktionen.



 Om det finns för lite kaffeböner i bönbehållaren eller för lite vatten i vattentanken för inställd bryggningsmängd eller om sumpbehållaren är full avbryts bryggningen och pågående program stoppas. Efter det felet avhjälppts måste programmet startas på nytt. Härvid måste den kaffemängd som redan finns i kannan beaktas i annat fall finns risk att kannan rinner över.

 När symbolerna  och  blinkar, är kaffepulvret för finmalet. Ändra malningsgradens inställning, se „Inställning av malningsgrad“ Sida 176.

## 8 Kaffebyggning med pulver

Med denna funktion kan malet kaffe, t.ex. **koffeinfritt kaffe**, bryggas.

 Obs! Kontrollera att pulver inte blir hängande i kanalen och att inga främmande partiklar hamnar i kanalen. Påfyllningskanalen är inte en förrådsbehållare, pulvret måste hamna direkt i bryggningseenheten.

 Vrid ratten "Kaffesmak / förmalet kaffe" (bild 20) till önskat läge  (för 1 kopp) eller  (för 2 koppar) för

S

val av funktionen för förmalet kaffepulver. Härvid frångörs kaffekvarnen. En symbol ☞ (för 1 kopp) eller båda symbolerna ☞ ☞ (för 2 koppar) lyser.

- ☞ Öppna locket på kaffepulverkanalen och fyll på färskt kaffepulver (bild 21). Använd endast medföljande mått. Fyll på högst 2 mått, i annat fall brygger automaten inget kaffe, kaffepulvret sprids i bryggaren och förorenar den, eller så ges kaffet ut droppvis och symbolerna ☞ och ☞ blinkar.

Under brygning får kaffepulver inte fyllas på. Först när brygningen är helt avslutad och bryggaren åter står i beredskap får kaffepulver för nästa kopp fyllas på. Kaffepulver får aldrig fyllas på när bryggaren är frånslagen; risk finns att kaffet sprids i bryggaren.

- ⚠ Använd endast kaffepulver för helautomatisk espressobryggare. Kaffeböner, vattenlösliga och djupfrysta instantprodukter eller andra pulver för drycker får absolut inte fyllas på. Ett för finmalet kaffepulver kan täppa till kanalen.

- i Om påfyllningskanalen är tilltäppt (till följd av fukt i bryggaren eller pga. att mer än 2 mått kaffepulver fyllts på) skjut ned pulvret med en kniv eller skedskaft (bild 22). Ta sedan bort bryggningsenheten och rengör den tillsammans med kaffe-bryggaren enligt beskrivning under „Rengöring av bryggningsenhet“ Sida 178".

- ☞ Stäng locket.

- ☞ Välj med ratten "Koppstorlek" (bild 12) önskad koppstorlek enligt beskrivning i avsnittet „Kaffe-brygning med böner" Sida 171.

- ☞ Tryck knappen "1 kopp kaffe" ☞ för brygning av en kopp eller knappen „2 koppar" ☞☞ för 2 koppar. Nu bryggs kaffet.

- i Om för förmalet kaffe funktionen för 1 kopp valts, men kaffepulver inte fyllts på i kaffepulverkanalen, blinkar sym-

bolerna ☞ och ☞ när knappen ☞ trycks. Om för förmalet kaffe funktionen för 2 koppar valts, men kaffepulver inte fyllts på i kaffepulverkanalen, blinkar när knappen ☞☞ trycks symbolerna ☞ ☞ och ☞.

- i För att efter kaffe-brygning återgå till funktionen för kaffeböner, vrid ratten "Kaffestyrka / förmalet kaffe" (bild 20) till önskat läge för kaffets styrka (nu kan åter kaffekvarnen användas).

## 9 Uppskumning av mjölk

Ångan kan användas för uppskumning av mjölk och uppvärmning av vätskor. För alstring av ånga krävs en högre temperatur än för kaffe-brygning och kaffe-bryggaren har därför försetts med en extra ångfunktion.

- i För en portion cappuccino fylls en kopp till 1/2 - 2/3 med espresso och sedan tillsätts den skummade mjölken.

- ⚠ **Obs! Skållningsrisk vid påkopplat ångmunstycke! Risk finns för att hett vatten eller het ånga leder till skållning. Koppla på ångmunstycket först sedan det doppats ned i mjölken.**

- ☞ För förberedelse av ånga tryck på knappen „Ånga" ☞☞ (bild 23).

Symbolen ☞ lyser och bryggaren värms upp. Under uppvärmning blinkar symbolen ☞.

Efter avslutad uppvärmning lyser symbolen ☞ med fast ljus. Bryggaren är nu förberedd för uppskumning av mjölk.

- i Om ångfunktionen inte används under 2 minuter kopplas bryggaren automatiskt om till kaffe-brygning.



- i För att undvika att restvatten vid uppskumning blandas i mjölken bör vatten först tappas av. Håll ett kärl under ångmunstycket och vrid ratten för ånga och hett vatten (bild 10) och håll den i detta läge ☞☞ tills ånga avgår. Vrid sedan ratten tillbaka till läget ●.

 Håll upp lågt fetthaltig och kall mjölk i en bägare som passar in under bryggarens ångmunstycke.

 Mjölken skall vara välkyld. Använt kärl skall också vara kallt, lämpligast är ett kärl i rostfritt stål som inte får sköljas i varmt vatten.



 Sväng ångmunstycket utåt och håll muggen under så att ångmunstyckets öppning är nätt och jämnt indoppad i mjölken (bild 24).

 **Obs!** Intorkade mjölkrester i ångmunstycket. Se till att ångmunstycket inte doppas in för djupt i mjölken så att luftinsugningsöppningen upptill på ångmunstycket är täckt av mjölk. Härvid finns risk att mjölk sugas in i munstycket och sedan leder till förorening av ångmunstycket.

 Vrid ratten för ånga och hett vatten (bild 10) till läget . Mjölken skummas upp.



 För att uppnå ett krämigt mjölkskum kan kärlet långsamt föras nedåt och uppåt. Skumma upp mjölken tills minst dubbel mängd erhålls.

 Vi rekommenderar att högst 2 minuter kontinuerligt tappa ånga.



 Avsluta uppskumningen genom att vrida ratten för ånga och hett vatten (bild 10) till läget  och ta sedan bort kärlet.

 **Obs!** Risk för skållning finns om het mjölk stänker ut! Stäng av ångan innan du drar ut kärlet med uppskummad mjölk.

 Lämna ångfunktionen med knappen "Ånga" (bild 23) eller vänta ca 120 sekunder tills bryggaren automatiskt återgår till bryggningsfunktionen. Bryggaren är nu åter klar för kaffe-brygning.



 Låt efter uppskumning av mjölk helt kort hett vatten rinna ur munstycket genom att vrida ratten för ånga och hett vatten (bild 10) till läget .

Detta är nödvändigt för att inte rester av mjölk skall torka in och eventuellt täppa till munstycket. Använd ett lämpligt kärl för uppsamling. Under denna process lyser symbolen .

 Ställ nu åter ratten för ånga och hett vatten till läget , på displayen visas senast vald kaffeinställning.

### 9.1 Renföring av ångmunstycket

**Viktigt:** Av hygieniska skäl rekommenderar vi att efter varje uppskumning av mjölk rengöra munstycket enligt beskrivning nedan. Härvid undviks att mjölk avlagras i ångmunstycket.

 Vrid ratten för ånga och hett vatten medurs mot stopp till läget . Vänta ett par minuter tills ångmunstycket svalnat.

 Grip tag i svängrörets svarta låsdel och öppna ångmunstyckets bajonettlås genom att vrida röret en aning medurs. Dra bort ångmunstycket nedåt (bild 25).

 Dra bort ångmunstyckets inre del nedåt från svängröret.

 Rengör ångmunstycket och den inre delen med varmt vatten.

 Kontrollera att de båda hålen inte är tilltäppa se fig 26. Om så behövs stöt igenom med en nål och rengör.

 Montera åter den inre delen genom att försiktigt skjuta upp den på svängröret.

 Återmontera ångmunstycket genom att skjuta upp och vrida det moturs.



## 10 Hetvattenberedning

Hetvattnet kan användas för förvärmning av koppar och för tillredning av heta drycker som t.ex. te eller färdigsuppor.

 **Obs!** Skållningsrisk vid påkopplat ångmunstycke! Avgående hett vatten kan leda till skållning. Koppla på hetvattenmunstycket endast när ett kärl står under munstycket.

 Ställ ett kärl under hetvattenmunstycket.

S

☞ Vrid ratten för ånga och hett vatten till läget  (bild 10). När hett vatten ges ut; lyser symbolen .

**i** Vi rekommenderar att högst 2 minuter kontinuerligt tappa ånga



☞ Efter det hetvatten tappats vrid ratten för ånga och hett vatten tillbaka till läget  (bild 10) och ta bort kärlet.

## 11 Inställning av malningsgrad

Kvarnen har vid fabriken ställts in på medelhög malningsgrad. Om kaffetappningen är för snabb eller för långsam (droppvis) kan malningsgraden under malning ändras.

**!** Malningsgraden får endast ändras under malning, dvs knappen för inställning av malningsgrad (bild 2, T och bild 27) får vridas endast så länge kvarnen malar kaffeböner. Vid inställning på fränkopplad kvarn kan kaffebryggaren skadas.

☞ Ställ in malningsgraden med ratten för inställning av malningsgrad (bild 2, T) (bild 27).

- Om kaffet rinner ut droppvis eller inte fullständigt (eventuellt blinkar symbolerna  och ) , måste knappen vridas med ett läge medurs. Vrid alltid i steg om ett läge tills kaffetappningen är tillfredsställande.
- Om kaffet rinner ut för snabbt och Creman inte är i din smak vrid ratten ett läge moturs.

**i** Se till att ratten för malningsgradinställning inte vrids för långt, detta kan leda till att vid tappning av 2 koppar kaffet ges ut droppvis.

**i** Korrigeringarnas effekt märks först efter minst 2 kaffebrygningar i följd.

### Avlägsna främmande partiklar ur kvarnen





Främmande partiklar som t.ex. små stenar kan skada kvarnen. En främmande partikel i kaffet förorsakar ett jämnt och högljutt knatter. Om ett sådant ljud uppstår under malning koppla

genast från bryggaren och ta kontakt med kundtjänsten. **Om kvarnen blockerar eller skadas av främmande partiklar kan vi frita oss från allt ansvar.**

## 12 Inställning av kaffetemperaturen

Du kan välja mellan tre temperatursteg. Vid fabriken har "Temperatur hög" ställts in. Temperaturen kan ändras så här:

☞ Tryck på knappen „P“ (bild 4).



Symbolerna "P" och  lyser. Dessutom lyser de 3 små symbolerna ovanför knapparna ,  och , för att visa knapparnas aktuella funktion, se „Specialmod“ Sida 169.

☞ Tryck på knapparna bläddra "<" eller ">" (bild 5) tills symbolen  tänds.

☞ Bekräfta med knappen „OK“ (bild 5). På displayen visas aktuell inställning. Temperaturerna visas så här:

 låg temperatur

  medelhög temperatur

   hög temperatur

☞ Välj vid behov med knapparna bläddra "<" eller ">" (bild 5) en annan temperatur.

☞ När önskad temperatur visas, bekräfta med knappen „OK“ (bild 5). Temperaturen är nu programmerad.

**i** För att avbryta utan att spara, tryck på "P" i stället för "OK".

**i** Om „OK“ inte trycks återgår bryggaren efter ca 120 sekunder automatiskt till brygningsfunktion utan att spara inmatningarna.











☞ För att gå tillbaka till brygningsfunktionen tryck på knappen „P“ (bild 4) eller vänta ca 120 sekunder tills bryggaren automatiskt återgår till brygningsfunktionen.



## 13 Rengöring och skötsel





Håll kaffebryggaren ren för att uppnå konstant kaffekvalitet och störningsfri funktion.

### 13.1 Regelbunden rengöring



-  **Obs!** Slå ifrån bryggaren innan rengöring påbörjas. Låt bryggaren svalna.
-  **Obs!** Varken bryggaren eller dess delar får diskas i diskmaskin. Kaffebryggaren får absolut inte doppas i vatten.
-  **Obs!** Häll aldrig vatten i bönbehållaren, i annat fall finns risk för att kvarnen skadas.
-  Använd inte skrapande, skurande eller frätande medel. Torka av bryggarens hus in- och utvändigt endast med en fuktig trasa.
-  Ta varje dag bort vattentanken (bild 6) och håll bort restvattnet. Skölj vattentanken med rent vatten. Använd varje dag nytt vatten.
-  Töm sumpbehållaren dagligen eller senast när texten på displayen kräver tömning, se „Tömning av sumpbehållaren“ Sida 177.
-  Töm droppskålen regelbundet. Dock senast när droppskålens röda flottör (bild 28) dyker upp i droppgallrets öppning.
-  Rengör regelbundet minst en gång i veckan, vattentanken (N), droppskålen (O), droppgallret (A) och sumpbehållaren (Q) med varmt vatten, mildt diskmedel och eventuellt med en pensel.
-  Ta efter varje uppskumning bort skumningsröret och avlägsna noggrant alla mjölkavlagringar, se „Renföring av ångmunstycket“ Sida 175.
-  Kontrollera att kaffeutloppets öppningar inte är tilltäppta. Med en nål kan utloppet rengöras från intorkat kaffe (bild 29).

### 13.2 Tömning av sumpbehållaren

Bryggaren räknar antalet kaffetappningar. Efter 14 enkla (eller 7 dubbla) kaffebrygningar tänds symbolen  som hänvisar till att sumpbehållaren är full och att den måste tömmas och rengöras. Sumpbehållaren måste rengöras innan kaffebrygning kan fortsättas.

-  För rengöring lås upp och öppna serviceluckan med öppningsknappen (bild 30), symbolen  lyser.
-  Ta sedan bort droppskålen (bild 31), töm och rengör den.
-  Töm och rengör noggrant sumpbehållaren. Se till att alla avlagringar på botten avlägsnas.



**Viktigt:** Varje gång när droppskålen dras ut **måste** även sumpbehållaren tömmas även om den inte är helt full. Om detta inte gjorts kan det vid nästa kaffebrygning hända att sumpbehållaren blir för full och kaffesumpen täpper då till kaffebryggaren.

 När droppskålen tas bort, blinkar symbolen .

 Om bryggaren används varje dag, töm även behållaren varje dag. Töm alltid sumpbehållaren vid påkoppad bryggare. Då registrerar bryggaren att tömning skett.

### 13.3 Rengöring av kvern

Kafferester kan ur bönbehållaren avlägsnas med en mjuk pensel eller en dammsugare.

-  **Obs!** Se till att vatten inte tränger in i kvarnen, i annat fall finns risk för att kvarnen skadas.
-  Koppla från bryggaren med knappen Till/Från (bild 11) och huvudströmstäl-laren (bild 8) aus. Dra ur stickkontakten.
-  Ta bort resterande kaffeböner (använd eventuellt dammsugare med slang eller fogmunstycke).

S

**i** Om en främmande partikel inte kan tas bort, ta kontakt med kundtjänsten. **Om kvarnen blockeras eller skadas av främmande partiklar kan vi frita oss från allt ansvar.**

**!** **Obs!** Risk för kroppsskada vid roterande kvarn. Koppla aldrig på bryggaren om du arbetar med kvarnen. Detta kan leda till allvarliga skador. Dra alltid ut stickproppen.

**☞** Kontrollera nu kvarnens funktion genom att med en liten mängd bönor brygga kaffe. Vid första malningen eller efter rengöring matas en mindre mängd kaffepulver till bryggningseenheten eftersom kanalen måste fyllas. Detta kan påverka första kaffets kvalitet.

### 13.4 Rengöring av bryggningseenhet

Vi rekommenderar regelbunden rengöring av bryggningseenheten (alltefter utnyttjandefrekvens). Om bryggaren inte kommer att användas under en längre (t.ex. semester) skall sumpbehållaren och vattentanken tömmas och bryggaren inklusive bryggningseenheten noggrant rengöras.

Förfar så här:

**☞** Koppla från kaffe bryggaren med knappen Till/Från (bild 11) (dra inte ut stickkontakten) och vänta tills alla symboler slocknar!

**☞** Lås upp och öppna serviceluckan med öppningsknappen (bild 30).

**☞** Ta bort och rengör sumpbehållaren (bild 31).

**☞** Tryck in bryggningseenhetens röda upplåsningknappar (bild 32) och dra ut bryggningseenheten.

**i** **Obs!** Bryggningseenheten kan tas ut endast om bryggaren kopplats från med knappen Till/Från **⓪** på bryggarens framsida. Bryggaren skall inte kopplas bort från strömnätet. Försök inte ta ut bryggningseenheten vid påkopplad kaffe bryggare, risk finns för att bryggaren skadas.

**☞** Rengör bryggningseenheten utan diskmedel under rinnande kranvatten. **Bryggningseenheten får inte rengöras i diskmaskin.**

**☞** Rengör bryggaren även invändigt. Skrapa bort kaffeskorporna i bryggaren med en trä- eller plastgaffel eller annat föremål som inte skrapar ytan (bild 33) och sug sedan med en dammsugare bort alla återstoder (bild 34).

**☞** För återinsättning av bryggningseenheten (bild 36, a) skjut in den i hållaren (bild 36, b) och mot stiftet (bild 36, c). Stiftet måste gå in i röret (bild 36, d) nedtill på bryggningseenheten.

**☞** Tryck kraftigt mot PUSH (bild 36, e) tills bryggningseenheten hörbart snäpper fast.

**☞** Kontrollera efter det enheten snäppt fast att de röda knapparna (bild 36, f) hoppat ut, i annat fall kan serviceluckan inte stängas.

Bild 37: De röda knapparna har hoppat ut korrekt.

Bild 38: De röda knapparna har inte hoppat ut.

**☞** Sätt åter in droppskålen tillsammans med sumpbehållaren.

**☞** Stäng serviceluckan.

**i** Om bryggningseenheten inte är korrekt insatt, dvs den har inte snäppt fast hörbart och de röda knapparna har inte hoppat ut, kan serviceluckan inte stängas.

**i** Om bryggningseenheten går trögt att skjuta in, måste den (före insättning) ställas in på rätt höjd genom att kraftigt trycka ihop enheten som bilden 35 visar.

**i** Går bryggningseenheten fortfarande trögt, stäng serviceluckan, dra ut stickkontakten ur vägguttaget och anslut igen.

Vänta tills alla symboler slocknar, öppna serviceluckan och skjut åter in bryggningseenheten.

### 13.5 Avkalkning





Med avkalkningsprogrammet kan bryggaren lätt och effektivt avkalkas. Den tända symbolen  hänvisar till att bryggaren måste avkalkas.



 **Obs!** Använd absolut inte avkalkningsmedel som AEG/Electrolux inte rekommenderat. Om avkalkningsmedel av främmande fabrik används fritar sig AEG/Electrolux från allt ansvar för eventuella skador. Avkalkningsmedel kan köpas i fackhandel eller beställas hos AEG/Electrolux serviceline.



 **Avkalkningsprocessen tar ca 45 minuter och får inte avbrytas. Vid strömavbrott måste programmet startas på nytt.**



 Innan avkalkningsprogrammet startas, rengör bryggningssenheten (se „Rengöring av bryggningssenhetsenhet“ Sida 178).

 Tryck på knappen „P“ (bild 4).

Symbolerna "P" och  lyser. Dessutom lyser de 3 små symbolerna ovanför knapparna ,  och , för att visa knapparnas aktuella funktion, se „Specialmod“ Sida 169.

 Tryck på knapparna bläddra "< eller >" (bild 5) tills symbolen  tänds.



 Bekräfta med knappen "OK" (bild 5). Symbolerna  och  blinkar och "P" lyser med fast ljus.



 För att avbryta avkalkningsprogrammet på detta ställe, koppla från bryggaren med knappen "Till/Från"  (bild 11).

 Töm vattentanken, fyll på minst 1 liter vatten och tillsätt avkalkningsmedlet.



 **Obs!** Se till att stänk från avkalkningsmedlet inte hamnar på syrakänsliga ytor som t.ex. marmor, kalksten och keramik.



 Ställ upp ett kärl med minst 1,5 liters volym under ångmunstycket (bild 9)

 Ställ ratten för ånga och hett vatten i läget .

Avkalkningsprogrammet startar och avkalkningsvätskan rinner ut genom ångmunstycket. Symbolerna  och  "P" lyser med fast ljus.

Avkalkningsprogrammet utför automatiskt flera sköljningar och pauser för att avlägsna kalkavlagringar ur kaffe-bryggaren.



Efter ungefär 30 minuter är vattentanken tom och symbolerna  och  blinkar och "P" lyser med fast ljus.



 Ställ ratten för ånga och hett vatten i läget .



Kaffebryggaren är nu klar för sköljning med rent vatten.



 Ta bort vattentanken, fyll på färskt vatten och sätt åter in tanken.

 Töm kärlet som står under ångmunstycket och ställ sedan tillbaka under munstycket.

 Ställ ratten för ånga och hett vatten i läget .

Kärlet sköljs med rent vatten och vattentanken rinner ut genom ångmunstycket. Symbolerna  och  "P" lyser med fast ljus.

Efter några minuter är vattentanken tom och symbolerna  och  blinkar och "P" lyser med fast ljus.

 Ställ ratten för ånga och hett vatten i läget .

Symbolerna för senast vald kaffefunktion visas och symbolen  lyser med fast ljus.

 Töm sköljvattnet ur kärlet.

 Ta bort vattentanken, fyll på färskt vatten och sätt åter in tanken.

Bryggaren är nu åter driftklar och i senast valt tillstånd för bryggningssfunktion.

 **Vi rekommenderar att efter avkalkningsprogrammet hälla bort den första koppen kaffe.**

S

## 14 Beställning av tillbehör

För att du länge skall kunna använda din kaffebruggare och för att undvika defekter, är det viktigt att regelbundet rengöra och avkalka bryggaren. Original avkalkningsmedel kan även beställas direkt hos oss.

Ta i Tyskland kontakt med vår order-hotline:

1801 - 20 30 60\*



(\*Lokaltaxa ur Deutsche Telekom's fastnät)  
måndag till fredag kl. 8.00 - 18.00

## 15 Vad göra om på displayen följande meddelande visas...

### Symbolen lyser med fast ljus

- Vattentanken är tom eller inte riktigt insatt.
- ☞ Fyll på tanken och sätt in de på rätt sätt, se „Påfyllning av vatten“ Sida 169.
- Vattentanken är smutsig eller kalkavlagringar har bildats.
- ☞ Skölj eller avkalka vattentanken.

### Symbolerna och blinkar

- Kaffebruggaren kan inte längre brygga kaffe.
- ☞ Ställ ett kärl under ångmunstycket och vrid ratten för ånga och hett vatten moturs till läget   (bild 9).
- Kaffet rinner långsamt ut.
- ☞ Vrid ratten för inställning av malningsgrad (bild 12) ett läge medurs så länge kvarnen för kaffebruggning maler kaffeböner (se „Inställning av malningsgrad“ Sida 176).

### Symbolen lyser med fast ljus

- Sumpbehållaren är full.
- ☞ Töm sumpbehållaren enligt beskrivning i „Tömning av sumpbehållaren“ Sida 177, rengör och sätt åter in den.

### Symbolen blinkar

- Sumpbehållaren har efter rengöring inte satts in.
- ☞ Öppna serviceluckan och sätt in sumpbehållaren.

### Symbolerna eller och blinkar

- Efter val funktionen för föralet kaffe har kaffepulver inte blivit tillsatt i påfyllningskanalen.
- ☞ Tillsätt kaffepulver enligt beskrivning under „Kaffebruggning med pulver“ Sida 173.

### Alla symbolerna för kaffestyrka och blinkar

- Det finns inte längre kaffeböner i kaffebönbehållaren.
- ☞ Påfyllning av kaffebönbehållaren, se „Påfyllning av kaffebönsbehållaren“ Sida 169.
- Om kvarnen blir mycket högljudd, kan orsaken vara att en liten sten blockerat kvarnen.
- ☞ Ta kontakt med kundtjänsten. Om kvarnen blockeras eller skadas av främmande partiklar kan vi frita oss från allt ansvar.

### Symbolen lyser med fast ljus

- Detta betyder att kalkavlagringar uppstått i kaffebruggaren.
- ☞ Avkalkningsprogrammet som beskrivs i kapitlet „Avkalkning“ Sida 179 måste köras så fort som möjligt.

### Symbolen lyser med fast ljus

- Serviceluckan är öppen.
- ☞ Stäng serviceluckan. Om serviceluckan inte går att stänga, kontrollera att bryggningensheten är korrekt insatt (se „Rengöring av bryggningenshet“ Sida 178)

### Symbolen blinkar



- Troligen har bryggningensheten efter rengöring inte åter satts in i kaffebruggaren.
- ☞ Insättning av bryggningenshet, se „Rengöring av bryggningenshet“ Sida 178

- Kaffebryggaren är invändigt kraftigt förorenad.
- ☞ Rengör bryggaren även invändigt, "Rengöring av bryggningsenhet" Sida 178. Om meddelandet kvarstår efter det kaffebryggaren rengjorts, ta kontakt med kundtjänsten.

#### Symbolen lyser med fast ljus

- Detta hänvisar till ett generellt larm.
- ☞ Ta kontakt med kundtjänsten.

#### Symbolerna och blinkar

- Kaffebryggaren har kopplats på med ratten för ånga och hett vatten i läget "öppen" .
- ☞ Vrid ratten för ånga och hett vatten medurs (bild 10) mot stopp till läget .

#### Symbolerna och blinkar

- Omgivningstemperaturen är för låg för användning av kaffebryggaren.
- ☞ Sök upp ett varmare rum.

## 16 Problem som kan lösas innan kundtjänsten rings upp

Om kaffebryggaren inte fungerar, kan orsaken till störningen lätt lokaliseras och åtgärdas genom att läsa anvisningarna i kapitlet „Vad göra om på displayen följande meddelande visas..." Sida 180. Om kaffebryggaren inte visar någon symbol, kontrollera följande punkter innan kundtjänsten rings upp.

#### Kaffet är inte hett

- Kopporna har inte förvärmats.
- ☞ Förvärm kopporna genom att skölja dem i varmt vatten eller låta dem stå minst 20 minuter på den uppvärmda ställplatsen för koppar (H) (se „Tips för tappning av hetare kaffe:" Sida 172).

#### Kaffet har lite Crema

- Kaffet är för grovt malet.
- ☞ Vrid knappen för inställning av malningsgrad ett läge moturs så länge kvarnen maler kaffeböner för kaffe-

brygning (se „Inställning av malningsgrad" Sida 176).

- Kaffeblandningen är inte lämplig.
- ☞ Välj en kaffeblandning som är lämplig för kaffeautomater.

#### Kaffet rinner för långsamt ut.

- Kaffet är för fint malet.
- ☞ Vrid knappen för inställning av malningsgrad ett läge medurs så länge kvarnen maler kaffeböner för kaffebrygning (se „Inställning av malningsgrad" Sida 176).

#### Kaffet rinner för snabbt ut.

- Kaffet är för grovt malet.
- ☞ Vrid knappen för inställning av malningsgrad ett läge moturs så länge kvarnen maler kaffeböner för kaffebrygning (se „Inställning av malningsgrad" Sida 176).

#### Kaffet rinner ut endast genom kaffeutloppets ena pip

- Pipens hål är tilltäppta.
- ☞ Avlägsna intorkat kaffe med en nål (bild 29).

#### Även om ratten för ånga och hett vatten vrids, avges ingen ånga genom ångmunstycket

- Ångmunstyckets små hål och ångmunstyckets inre del är tilltäppta.
- ☞ Rengör ångmunstyckets små hål och ångmunstyckets inre del (se „Rengöring av ångmunstycket" Sida 175).

#### När funktionen eller kommer inget kaffe utan endast vatten ur bryggaren

- Eventuellt har kaffepulvret fastnat i påfyllningskanalen.
- ☞ Luckra upp kaffepulvret i påfyllningskanalen med en kniv (se „Kaffebrygning med pulver" Sida 173) (bild 22). Rengör sedan bryggningsenheten och bryggaren invändigt (se „Rengöring av bryggningsenhet" Sida 178)

S

### Med knappen ① kan bryggaren inte kopplas på

- Huvudströmställaren på bryggarens baksida är inte tillslagen (bild 8) eller stickkontakten är inte kopplad.

☞ Kontrollera att huvudströmställaren står i läget „I” och att stickkontakten sitter ordentligt i vägguttaget.

### Bryggningseenheten går inte att ta ut för rengöring

- Kaffe-bryggaren är påkopplad. Bryggningseenheten kan endast tas bort när bryggaren är frånslagen.

☞ Koppla från bryggaren och ta ut bryggningseenheten (se „Rengöring av bryggningseenhet” Sida 178).

**i** Obs! Bryggningseenheten kan tas ut endast om bryggaren kopplats från med knappen Till/Från ① på bryggarens framsida. Bryggaren skall inte kopplas bort från strömnätet. Försök inte ta ut bryggningseenheten vid påkopplad kaffe-bryggare, risk finns för att bryggaren skadas.

### Kaffet rinner inte ut genom kaffeutloppets pipar, utan vid sidan om serviceluckan

- Kaffeutloppets öppningar är tilltäppta med intorkat kaffe.

☞ Avlägsna intorkat kaffe med en nål (bild 29).

- Utsvängfacket (R) på serviceluckans insida är blockerat och kan inte svängas ut.

☞ Rengör utsvängningsfacket noggrant, speciellt kring gångjärnen så att de hålls rörliga.

### Kaffepulver har använts (i stället för kaffeöror) och inget kaffe ges ut.

- För mycket förmalet kaffe har fyllts på.

☞ Ta bort bryggningseenheten och rengör noggrant bryggaren invändigt beskrivning under „Rengöring av bryggningseenhet” Sida 178. Upprepa proceduren och fyll på högst 2 mått kaffepulver.

- Ratten för "Kaffestycka / förmalet kaffe" har inte ställts i läget ☞ eller ☞☞ och bryggaren har använt både förmalet kaffe och kaffet som malats i kvarnen.

☞ Rengör noggrant bryggaren invändigt enligt beskrivning under „Rengöring av bryggningseenhet” Sida 178. Upprepa processen och ställ först ratten för "Kaffestycka / förmalet kaffe" i korrekt läge enligt beskrivning under „Kaffe-bryggning med pulver” Sida 173.

- Förmalet kaffe har fyllts på vid frånkopplad bryggare.

☞ Ta bort bryggningseenheten och rengör noggrant bryggaren invändigt enligt beskrivning under „Rengöring av bryggningseenhet” Sida 178. Upprepa proceduren med påkopplad bryggare.

### Hur skall bryggaren transporteras?

- Spara originalförpackningen för transport. För att skydda bryggaren mot skrämor skall originalplastpåsen användas.
- Skydda bryggaren och varmhållningskannan mot stötar. Vi fritar oss från allt ansvar för skador som uppstår under transport.
- Töm vattentanken och sumpbehållaren.
- Se till att bryggaren under den kalla årstiden står på ett skyddat ställe. Risk finns i annat fall att frostskada uppstår.

## 17 Statistikmod

Följande värden kan avfrågas:





- mängden av kaffe som hittills tillagats med bryggaren,
- antalet bryggda kannor med 4 koppar, 6 koppar, 8 koppar och 10 koppar,
- antalet avkalkningar och dessutom
- mängden av vatten i liter som bryggaren gett ut.

**i** Om samtidigt 2 koppar kaffe hälls upp, registreras även 2 koppar.

För inkoppling av statistikmoden måste bryggaren vara frånkopplad.

☞ Koppla från bryggaren med knappen "Till/Från"  (bild 11).

☞ Tryck knappen "P" (bild 4) minst 6 sekunder.

Symbolerna "P" och  lyser. Dessutom lyser de 3 små symbolerna ovanför knapparna ,  och , för att visa knapparnas aktuella funktion, se „Specialmod" Sida 169.

☞ Tryck på knapparna bläddra "<" eller ">" (bild 5) tills den symbol lyser för vilken tillhörande statistik skall visas:

 Antal kaffetappningar

 Antalet avkalkningar

 Antalet bryggda kannor med 4 koppar

 Antalet bryggda kannor med 6 koppar

 Antalet bryggda kannor med 8 koppar

 Antalet bryggda kannor med 10 koppar

 Mängd tappat < vatten i liter

När en symbol lyser, kan tillhörande antal visas så här:

☞ Tryck på knappen "OK" och håll den nedtryckt (bild 5).

Nu börjar de enskilda indikeringarna blinka och anger avfrågat antal:

 1 blink motsvarar 1

 1 blink motsvarar 10

 1 blink motsvarar 100

 1 blink motsvarar 1,000

 1 blink motsvarar 10,000

Blinkningarna upprepas tills knappen "OK" trycks. Före varje upprepning hålls en paus på 3 sekunder.

☞ Räkna de enskilda blinkningarna. Exempel: Blinkningarna nedan motsvarar antalet 1 529.

 9 blink

 2 blink

 5 blink

 1 blink

 0 blink

☞ Tryck knappen "P" (bild 4) minst 6 sekunder för att lämna statistikmoden.

## 18 Tekniska data

Nätspänning: 220-240 V

Effektförbrukning: 1350 W

**CE** Kaffebryggaren uppfyller föreskrifterna i följande EG-direktiv:

- 73/23/EEG av den 19.2.1973 „Lågspänningsdirektiv", inklusive ändringsdirektiv 93/68/EEG.
- 89/336/EEG av den 3.5.1989 „EMC-direktiv", inklusive ändringsdirektiv 92/31/EEG.

S

## 19 Avfallshantering



### Förpackningsmaterial

Förpackningsmaterialet är miljövänligt och kan återanvändas. Plastdelarna är märkta, till exempel >PE<, >PS< etc. Lämna förpackningsmaterialet vid de kommunala återvinningsstationerna i därför avsedda behållare.



### Kasserad produkt

Symbolen  på produkten eller emballaget anger att produkten inte får hanteras som hushållsavfall. Den skall i stället lämnas in på uppsamlingsplats för återvinning av el- och elektronikkomponenter. Om produkten avfallhanteras på rätt sätt skyddar du miljön och dina medmänniskors hälsa. Miljön och hälsan kan skadas vid felaktig avfallshantering. För ytterligare upplysningar om återvinning bör du kontakta lokala myndigheter eller sophämtningstjänst eller affären där du köpte produkten.

## 20 Om service behövs

Ta vara på originalförpackningen och skumplastdelarna. För att undvika transportskada måste bryggaren förpackas ordentligt.

Om kaffebryggaren skickas in skall varmhållningskannan bifogas. Kannan behövs för testning av bryggaren.



**FIN Arvoisa asiakas**

on suositeltavaa lukea käyttöohje huolellisesti läpi ennen laitteen käyttöönottoa. Kiinnitä huomiota erityisesti turvallisuutta koskeviin ohjeisiin! Säilytä käyttöohje myöhempää tarvetta varten, ja luovuta se laitteen mahdolliselle seuraavalle omistajalle.

**Sisällysluettelo**

<b>1 Kuvien numeroiden selitykset</b>	<b>186</b>	<b>9 Maidon vaahdottaminen</b>	<b>195</b>
1.1 Etusivu (kuva 1)	186	9.1 Höyrystinpuhdistus	196
1.2 Etusivu avatulla huoltoluukulla (kuva 2)	186	<b>10 Kuumen veden valmistaminen</b>	<b>196</b>
1.3 Ohjaustaulu (kuva 3)	186	<b>11 Jauhatusasteen asetus</b>	<b>196</b>
<b>2 Kahvia ja espresso</b>	<b>187</b>	<b>12 Kahvin lämpötilan asettaminen</b>	<b>197</b>
<b>3 Turvaohjeita</b>	<b>187</b>	<b>13 Puhdistus ja hoito</b>	<b>197</b>
<b>4 Erikoistoiminto</b>	<b>189</b>	13.1 Säännöllinen puhdistus	197
<b>5 Ensimmäinen käyttöönotto</b>	<b>189</b>	13.2 Hylkykahviastian tyhjennys	198
5.1 Aseta laite paikoilleen ja liitä se	189	13.3 Myllyn puhdistus	198
5.2 Vesisäiliön täyttäminen	189	13.4 Vedenkuumennusyksikön puhdistus	198
5.3 Kahvipapusaaliön täyttäminen	189	13.5 Kalkinpoisto-ohjelman suoritus	199
5.4 Laitteen ensimmäinen käynnistäminen	190	<b>14 Lisävarusteiden tilaaminen</b>	<b>200</b>
5.5 Virran kytkeminen laitteeseen	190	<b>15 Mitä tulisi tehdä, jos näyttöön tulee seuraava viesti...</b>	<b>200</b>
5.6 Virran katkaiseminen laitteesta	190	<b>16 Ratkaistavat ongelmat, ennen kuin soitat asiakaspalveluun</b>	<b>202</b>
5.7 Veden kovuuden asetus	190	<b>17 Tilastotoiminto</b>	<b>203</b>
<b>6 Kahvin valmistaminen kahvipavuista</b>	<b>191</b>	<b>18 Tekniset tiedot</b>	<b>204</b>
6.1 Vihje kuumemman kahvin valmistuksesta	193	<b>19 Hävittäminen</b>	<b>205</b>
<b>7 Usean kahvikupillisen valmistus kannutoimintoa käyttäen</b>	<b>193</b>	<b>20 Huoltotapauksessa</b>	<b>205</b>
<b>8 Kahvin valmistaminen kahvijauheesta</b>	<b>194</b>		

FIN

## 1 Kuvien numeroiden selitykset

### 1.1 Etusivu (kuva 1)

- A Valumisritilä
- B Termoskannu
- C Pääkytkin (laitteen takasivussa)
- D Korkeudessa säädettävä kahviputki
- E Ohjaustaulu (katso kuva 3)
- F Kahvipapusaaliön kansi
- G Kahvijauhekuilun kansi
- H Kuumennettu kuppialusta
- J Höyryn ja kuumaveden kääntöputki
- K Höyrystin (irrotettavissa)
- L Höyrystintimen sisäosa (irrotettavissa)
- M Huoltoluukun avausnuppi
- N Max-merkillä varustettu vesisäiliö (irrotettavissa)
- O Uimurilla varustettu tippumalja (irrotettavissa)

### 1.2 Etusivu avatulla huoltoluukulla (kuva 2)

- P Huoltoluukku (auki)
- Q Hylkykahviastia (voidaan ottaa pois)
- R Kääntölokero
- S Vedenkuumennusyksikkö
- T Nuppi jauhausasteen säätöä varten
- U Kahvipapusaaliö
- V Mittalusikka
- W Esijauhetun kahvijauheen täyttökaukalo
- X Mallikilpi (laitteen pohjassa)
- Y Kalkinpoistoneste
- Z Testiliuskat

### 1.3 Ohjaustaulu (kuva 3)

- a Kiertonuppi "Kahvin voimakkuus / esijauhettu kahvi"
- b kiertonuppi "Kupin koko"
- c näyttöruutu
- d Painike "1 kuppi kahvia" ☐  
Erikoistoiminnossa tätä painiketta käytetään "selailuun" ("<")
- e Painike "2 kuppia kahvia" ☐  
Erikoistoiminnossa tätä painiketta käytetään "selailuun" (">")
- f Painike "Höyry" ☁  
Erikoistoiminnossa tämä painike vahvistaa valikkokohtaan ("OK")
- g Painike „P”  
Erikoistoiminnossa tällä painikkeella siirrytään takaisin edelliseen tasoon tekemättä muutoksia ("P")
- h Painike "virtakytkin" ⓪
- j Höyryn ja kuumaveden kiertonuppi
- k Painike "Kannutoiminto" ☐
- l Symbolit "Valmiiksi jauhettu kahvi"
- m Symbolit "Kannu"
- n Symbolit "Kahvin vahvuus"
- o Symbolit "Kuppikoko"
- p Symboli "Vesisäiliö tyhjä" ☁
- q Symboli "Kalkinpoisto" ☁
- r Symboli "Laitteen lämpötila" ↓
- s Symbol "Huoltoluukku auki" ☐
- t Symboli "Sakkasäiliö" ☁
- u Symboli "Huomio" ⚠
- v Symboli "Kuuma vesi" ☁
- w Symboli "Höyry" ☁
- x Symboli "2 kupillisen valmistus" ☐
- y Symboli "1 kupillisen valmistus" ☐
- z Erikoistoiminnon symbolit

## 2 Kahvia ja espressoa

Automaattisen kahviasemasi takaa yksinkertaisimman **käytön**, kahvinvalmistuksessa sekä myös huollossa ja hoidossa.

Seuraavassa luetellut seikat takaavat erinomaisen, yksilöllisen **maun**:

- Laite: kostuttaa kahvijauheen ennen varsinaista kahvin valmistusta, mikä saa esille kahvin koko aromin,
- Veden määrä kuppia kohti voidaan asettaa yksilöllisesti pienen espressokupillisen ja "pitkän" Crema-kahvin välille,
- valmistettavan kahvin lämpötila voidaan säätää yksilöllisesti,
- voidaan valita tavallisen tai vahvan kahvin välillä,
- kahvipapujen jauhatusaste voidaan säätää paahdon mukaisesti,
- ja tietenkin vahtokruunu (Crema), joka ehdottomasti kuuluu espressoon.

**Huomaa:** Kahvijauhe joutuu espressoa valmistettaessa kosketuksiin veden kanssa huomattavasti lyhyemmäksi ajaksi kuin suodatinkahvia valmistettaessa. Kahvijauheesta irtoaa näin vähemmän karvasaineita, mikä tekee espressosta helpommin sulavaa!

## 3 Turvaohjeita



Tämän laitteen turvallisuus vastaa tekniikan tunnettuja sääntöjä ja laite-turvallisuuslakia. Katsomme laitteen valmistajana kuitenkin velvollisuudeksemme tutustuttaa sinut seuraaviin turvallisuutta koskeviin ohjeisiin.

### Yleinen turvallisuus

- Laitteen saa liittää vain sähköverkkoon, jonka jännite, virtalaji ja taajuus vastaavat arvokilvessä (laitteen pohjassa) ilmoitettuja tietoja.
- Johto ei koskaan saa koskettaa laitteen kuumia osia.
- Älä vedä pistotulppaa pistorasiasta pitäen kiinni johdosta!
- Älä käytä laitetta, jos:
  - johto on vahingoittunut tai
  - siinä näkyy silmämääräisesti havaittavia vaurioita.
- Liitä pistoke pistorasiaan vain laitteen ollessa kytketty pois päältä.
- Tätä laitetta ei pidä käyttää henkilöt (lapset mukaan lukien), jotka kokemattomuuden tai tietämättömyyden takia eivät voi käyttää sitä turvallisesti tai henkilöt (lapset mukaan lukien), joiden fyysiset, aistilliset tai henkiset taidot ovat rajoitetut, paitsi jos heistä vastuussa oleva henkilö ohjaa heitä laitteen käytössä ja valvoo sitä.

### Lasten turvallisuus

- Älä poistu paikalta laitteen ollessa käynnissä. Pidä lapsia aina silmällä laitteen ollessa toiminnassa!
- Pakkausmateriaali, kuten esim. muovipussit, eivät sovi lasten käsiin.

### Käytön aikainen turvallisuus

- Huom! Kahviputki, höyrystin ja kuppialusta kuumenevat laitteen käytön aikana. Pidä lapset poissa laitteen läheltä!
- Huom! Toimiva höyrystin voi aiheuttaa palovammoja! Laitteesta ulos tuleva kuuma vesi / kuuma vesihöyry voi johtaa palovammoihin. Käynnistä höyrystin vain, kun sen alla on astia.

FIN

- Älä kuumenna höyryllä syttyviä nesteitä!
- Käytä laitetta vain, kun siinä on vettä! Laita vesisäiliöön vain kylmää vettä. Älä laita sinne kuumaa vettä, maitoa tai muita nesteitä. Ota huomioon, että säiliöön mahtuu enintään 1,8 litraa.
- Älä laita kahvipapusaäiliöön jäisiä tai karamellisoituja papuja, vaan ainoastaan paahdettuja kahvipapuja! Ota papujen joukosta pois kaikki niihin kuulumaton. Myllyyn joutuneista vieraista aineista aiheutuva tukkeutuminen tai vioittuminen ei saata kuulua takuun piiriin.
- Laita kahvijauheen täyttöaukkoon vain kahvijauhetta.
- Älä anna laitteen virran olla kytkettynä tarpeettomasti.
- Älä altista laitetta säätilan vaikutuksille.
- Jatkojohtona saa käyttää vain yleismallista johtoa, jonka johtimen halkaisija on vähintään 1,5 mm<sup>2</sup>.
- Motorisista häiriöistä kärsivien ihmisten ei tulisi koskaan käyttää laitetta yksinään, sillä se voi olla vaarallista.
- Käytä laitetta vain, kun valumisastia, hylkykahviastia ja valumisritilä ovat paikoillaan!

### Puhdistukseen ja hoitoon liittyvä turvallisuus

- Noudata puhdistukseen ja kalkinpoistoon liittyviä ohjeita.
- Katkaise virta ja vedä pistoke pistorasiasta ennen huoltotoimenpiteitä tai puhdistusta!
- Älä upota laitetta veteen.
- Puhdista höyryputki vain, kun virta on katkaistu ja putki on kylmä sekä paineeton!
- Älä pese laitteen osia astianpesukoneessa.
- Älä koskaan kaada myllyyn vettä, sillä vesi vaurioittaa sitä.

Älä avaa tai korjaa laitetta itse. Asiantuntemattomasti tehdyt korjaukset voivat aiheuttaa käyttäjälle huomattavia vaaratilanteita.



Vain sähköalan ammattilainen saa korjata sähkölaitteet.



Jos laite joudutaan korjaamaan tai sähköjohto on vaihdettava uuteen, ota yhteys

- ammattiliikkeeseen, josta hankit laitteen, tai
- AEG/Electrolux huoltopalveluun.

Takuu ei korvaa laitteen käyttötarkoituksen vastaisesta tai väärästä käytöstä mahdollisesti aiheutuvia vahinkoja. Takuu ei myöskään korvaa vahinkoja, joiden syynä on kalkinpoisto-ohjelman suorittamatta jättäminen tämän käyttöohjeen ohjeiden mukaisesti välittömästi, kun näyttöruutuun on tullut symboli . Myllyyn joutuneista vieraista aineista aiheutuva tukkeutuminen tai vioittuminen ei saata kuulua takuun piiriin.

## 4 Erikoistoiminto

Kun halutaan asettaa veden kovuus („Veden kovuuden asetus” Sivu 190) ja kahvin lämpötila („Kahvin lämpötilan asettaminen” Sivu 197), käynnistää kalkinpoisto-ohjelma („Kalkinpoisto-ohjelman suoritus” Sivu 199) ja katsoa tilastoa („Tilastotoiminto” Sivu 203), on kytkettävä erikoistoimintoon painamalla "P"-painiketta (kuva 4). Erikoistoiminnossa painikkeita "1 kupillinen kahvia" , "2 kupillista kahvia" , "Höyry"  ja "P" käytetään navigointiin. Toiminto näkyy näytössä painikkeen yläpuolella (kuva 5):

- «<» ("1 kuppi kahvia" ) ja «>» ("2 kuppia kahvia" ) ja mahdollistavat "selaamisen" valikon sisällä
- «OK» ("höyry" ) vahvistaa kohdan
- «P» ("P") palauttaa takaisin edelliselle tasolle ilman muutoksia

## 5 Ensimmäinen käyttöönotto

### 5.1 Aseta laite paikoilleen ja liitä se

Valitse sijoituspaikaksi sopiva, vaaka-suora, tukeva, lämmittämätön, kuiva ja vedenpitävä alusta.

 Huolehdi hyvästä ilmankierrosta. Laitteen sivuissa ja takana on oltava vapaata tilaa vähintään 5 cm, ja laitteen yläpuolella vähintään 20 cm. Laitetta ei saa pystyttää tiloihin, joissa lämpötila laskee arvoon 0°C tai sen alle (Jäätynyt vesi vaurioittaa laitetta).

 Huom! Jos laite siirretään kylmästä lämpimiin tiloihin, on odotettava n. 2 tuntia, ennen kuin siihen kytketään virta!

Laitteen alle kannattaa laittaa tarkoitukseen sopiva alusta, jotta vältettäisiin roiskeiden aiheuttamat vahingot.

 Liitä laite ainoastaan maadoitettuun pistorasiaan. Älä käytä maadoittamatonta pistorasiaa.

### 5.2 Vesisäiliön täyttäminen

Tarkista aina ennen kuin kytket laitteeseen virran, että vesisäiliössä on vettä. Lisää vettä tarvittaessa. Laite tarvitsee vettä käynnistymisen ja poiskytkemisen aikaisiin automaattisiin huuhteluvaiheisiin.

 Irrota vesisäiliö laitteesta (kuva 6). Kierrä aina höyrysuutin keskisenttoon, ennen kuin irrotat vesisäiliön, muuten et pysty irrottamaan vesisäiliötä.

 Täytä vesisäiliö raikkaalla, kylmällä vedellä. Älä koskaan täytä säiliötä MAX-merkin yli.

 Täytä vesisäiliöön vain kylmää vettä. Älä koskaan laita sinne muita nesteitä (esim. kivennäisvettä tai maitoa).

 Asenna vesisäiliö takaisin laitteeseen (kuva 6). Paina vesisäiliö tiukasti laitteeseen, jotta vesisäiliön venttiili avautuu.

 Jotta saisit aina hyvänmakuista kahvia:

- vaihda vesisäiliön vesi päivittäin,
- puhdista vesisäiliö vähintään kerran viikossa tavallisessa tiskivedessä (ei astianpesukoneessa). Huuhtelet lopuksi puhtaalla vedellä.

### 5.3 Kahvipapusaäiliön täyttäminen

 Avaa kahvipapusaäiliön kansi ja laita säiliöön tuoreita kahvipapuja (kuva 7). Sulje säiliön kansi.

 Huom! Käytä aina pelkkiä kahvipapuja, joiden seassa ei ole karamellisoituja tai aromatisoituja ainesosia. Älä käytä jäisiä papuja. Varmista, että papusaäiliöön ei saa pääse mitään vieraita aineita, kuten esim. kiviä. Myllyyn joutuneista vieraista aineista aiheutuva tukkeutuminen tai vioittuminen ei saata kuulua takuun piiriin.

 Mylly on tehtaalla asetettu keskikarkealle jauhatukselle. Tarvittaessa voit muuttaa tämän asetuksen. Lisätietoja jauhatustason asettamisesta löydät kohdasta „Jauhatustason asetus” Sivu 196.

FIN



Jauhatusasteen saa muuttaa vain jauhatuksen aikana. Säätöjen tekeminen kahvimyllyn ollessa pysähdyksissä voi vaurioittaa laitetta.



Kahvinkeitin on tarkistettu tehtaalla. Tähän käytetään kahvia, joten on aivan normaalia, jos löydät vähän kahvia myllystä. Takaamme joka tapauksessa, että tämä kahvinkeitin on uusi.

#### 5.4 Laitteen ensimmäinen käynnistäminen

Kahvinkeittimeen jäänyt ilma on poistettava ennen laitteen ensimmäistä käyttöä.



Kytke laite sen pohjassa sijaitsevalla pääkytkimellä (kuva 8).

Kun pääkytkin kytketään ensimmäisen kerran päälle, kaikkien näytön symbolien valot syttyvät itsetestausta varten. Sen jälkeen symbolit ☰ ja ▲ alkavat vilkkua.



Säiliön täyttö, katso „Vesisäiliön täyttäminen” Sivu 189.



Asenna vesisäiliö takaisin laitteeseen (kuva 6). Paina vesisäiliö tiukasti laitteeseen, jotta vesisäiliön venttiili avautuu.



Käännä höyrystin ulospäin ja aseta kuppi sen alle (kuva 9).



Kierrä höyryn ja kuumen veden kiertonappi mahdollisimman pitkälle vastapäivään, asentoon ☰ (kuva 10).

Höyrystinistä valuu hieman vettä. Symbolien ☰ ja ▲ valot palavat jatkuvasti.

Kun kuppiin on tullut vettä noin 30 dl, alkavat symbolien ☰ ja ▲ valot vilkkua.



Kierrä höyryn ja kuumen veden kiertonappi mahdollisimman pitkälle myötäpäivään, asentoon ● (kuva 10) veden ulostulon pysäyttämiseksi.

Symbolin ↓ valo vilkkuu muutaman sekunnin ajan ja laite kytkeytyy pois päältä.



Täytä kahvipapusaäiliö kahvipavuilla, katso „Kahvipapusaäiliön täyttäminen” Sivu 189.

#### 5.5 Virran kytkeminen laitteeseen

Tarkista aina ennen kuin kytket laitteeseen virran, että vesisäiliössä on vettä. Lisää vettä tarvittaessa. Laite tarvitsee vettä käynnistymisen ja poiskytketymisen aikaisiin automaattisiin huuhteluvaiheisiin.



Kytke laitteeseen virta siirtämällä virtakytkin ① asentoon päällä (kuva 11).



Laite suorittaa tarvittavat asetukset välittömästi käynnistyttyään. Sen aikana kuuluvat äänet ovat täysin normaaleja.



Symbolin ↓ valo vilkkuu lämmitysvaiheen ajan (n. 120 sekuntia).

Lämmityksen aikana laite suorittaa automaattisen huuhtelun (pieni määrä kuumaa vettä valuu kahviputkesta valumisastiaan).

Symbolin ↓ valo palaa yhtäjaksoisesti lämmitysvaiheen päätyttyä.

Laite on nyt käyttövalmis. Symbolien valot palavat viimeksi valitun kahvin valmistuksen toimintamuodon mukaisesti.

#### 5.6 Virran katkaiseminen laitteesta



Katkaise laitteen virta siirtämällä virtakytkin ① asentoon pois päältä (kuva 11).

Symbolin ↓ valo vilkkuu. Laite suorittaa huuhtelun ja kytkeytyy pois päältä.



Laite kytkeytyy energiansäästöysta automaattisesti pois päältä, jos se on käyttämättä yli kolmen tunnin ajan.



Jos et käytä laitetta pitkään aikaan, tulee sinun virtakytkimen katkaisun jälkeen lisäksi kytkeä laitteen pohjassa oleva pääkytkin pois päältä (kuva 8).

#### 5.7 Veden kovuuden asetukset

Ensimmäisen käyttöönoton jälkeen tai alettaessa käyttää erilaatuista vettä kuin aikaisemmin on laite säädettävä käytössä olevan veden kovuuden mukaisesti. Selvitä käytettävän veden kovuus laitteen mukana toimitetulla testiliuskalla tai kysy tietoja veden kovuudesta paikalliselta vesilaitokselta.

### Veden kovuuden määrittäminen

-  Upota testiliuska noin 1 sekunnin ajaksi kylmään veteen. Ravistele ylimääräinen vesi pois ja määritä veden kovuus vaaleanpunaisiksi värjäytyneiden alueiden perusteella.



Ei yhtään tai yksi vaaleanpunainen alue:

**kovuusaste 1, pehmeä**

enint. 1,24 mmol/l eli

7 saksalaista kovuusastetta eli

12,6° ranskalaista kovuusastetta

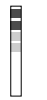

Kaksi vaaleanpunaista aluetta:

**kovuusaste 2, keskikova**

enint. 2,5 mmol/l eli

14° saksalaista kovuusastetta eli

25,2° ranskalaista kovuusastetta



Kolme vaaleanpunaista aluetta:

**kovuusaste 3, kova**

enint. 3,7 mmol/l eli

21° saksalaista kovuusastetta eli

37,8° ranskalaista kovuusastetta

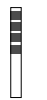

Neljä vaaleanpunaista aluetta:

**kovuusaste 4, erittäin kova**

enint. 3,7 mmol/l eli

yli 21° saksalaista kovuusastetta eli



yli 37,8° ranskalaista kovuusastetta

### Selvitetyt veden kovuuden asettaminen ja tallentaminen

Käytävissä on 4 eri kovuusastetta.

Tehtaalla laitteeseen on asetettu arvo 4.

-  Paina laitteen virran ollessa kytkettynä painiketta "P" (kuva 4).

Symbolien "P" ja  valot syttyvät. Sen lisäksi painikkeiden  ja , yläpuolella olevan 3 pienen symbolin valot syttyvät ilmoittamaan painikkeiden sen hetkisen toiminnon, katso „Erikoistoiminto” Sivuu 189.

-  Vahvista valinta "OK"-painikkeella (kuva 5).

Näyttö ilmoittaa sen hetkisen asetuksen. Kovuusasteet näytetään seuraavasti:



Kovuusaste 1



Kovuusaste 2





Kovuusaste 3



Kovuusaste 4

-  Paina sen jälkeen selauspainiketta "<"tai ">" (kuva 5) niin monta kertaa, kunnes selvitetty kovuusaste tulee näyttöruutuun.

-  Vahvista valikon kohta painikkeella "OK" (kuva 5). Kovuusaste on nyt tallennettu.

-  Kun haluat keskeyttää vaiheen asetusta tallentamatta, paina "P"-painiketta "OK"-painikkeen asemasta.

Ellei painiketta „OK" paineta, siirtyy laite n. 120 s kuluttua automaattisesti takaisin kahvin valmistuksen toimintamuotoon, tallentamatta syöttöjä.

-  Palaa kahvin valmistuksen toimintamuotoon painamalla lopussa painiketta "P" (kuva 4) tai odota n. 120 sekuntia, kunnes laite siirtyy sinne automaattisesti.

## 6 Kahvin valmistaminen kahvipavuista

Seuraavat kahvin valmistuksen vaiheet kuluva **papuja käytettäessä täysin automaattisesti**: jauhaminen, annostelu, puristus, kahvijauheen kostutus, kahvin valmistaminen ja kahvinporojen poisto.

Säättämällä jauhatusasteen ja jauhatusmäärän saat aina mieltymystesi mukaista kahvia.

-  Käytä aina pelkkiä kahvipapuja, joiden seassa ei ole karamellisoituja tai aromatisoituja ainesosia. Älä käytä jäisiä papuja. Varmista, että papusäiliöön ei saa pääse mitään vieraita aineita, kuten esim. kiviä. Myllyyn joutuneista vieraista aineista aiheutuva tukkeutuminen tai vioittuminen ei saata kuulua takuun piiriin.





Valitse makusi mukaan joko pieni espresso tai "pitkä" Crema-kahvi.

-  Valitse haluamasi kuppikoko kiertonupilla "Kuppikoko" (kuva 12). Valittu kuppikoko näkyy näyttöruudussa.

FIN



Kuppikoot näytetään seuraavasti:

-  espressokuppi
-  pieni kuppi
-  keskikokoinen kuppi
-  suuri kuppi
-  muki





Voit valita kahvisi erittäin miedolla, miedolla, normaalilla, voimakkaalla tai erittäin voimakkaalla maulla.



Valitse haluamasi kahvin vahvuus kiertonupilla "Kahvin voimakkuus" (kuva 13). Valittu kahvin voimakkuus näkyy näyttöruudussa.





Kahvin vahvuus näytetään seuraavasti:





-  erittäin mieto
-  mieto
-  normaali
-  vahva
-  erittäin vahva





Aseta kahviputkien alle yksi tai kaksi kuppia (kuva 14). Voit säätää kahviputken korkeuden kuppien korkeuteen sopivaksi työntämällä putkea ylös- tai alaspäin. Vältä näin lämmönhävikin ja kahvin roiskumisen (kuva 15).





Paina painiketta "1 kuppi kahvia"  yhden kahvikupillisen valmistusta varten tai painiketta "2 kuppia"  kahta kupillista varten.



Symbolin "1 kuppi"  tai "2 kuppia"  valo syttyy. Laite jauhaa nyt pavut. Laite kostuttaa kahvin valmistuksessa aluksi kahvijauheen pienellä määrällä vettä. Varsinainen kahvin valmistus tapahtuu kostutusta seuraavan lyhyen tauon jälkeen. Kahvi tulee kuppiin. Kun haluttu määrä kahvia on tullut ulos, laite lopettaa valmistuksen automaattisesti ja kaataa käytetyn kahvijauheen sakkasäiliöön. Tänä aikana symbolin "1 kuppi"  / "2 kuppia"  valo vilkkuu.



Voit milloin vain keskeyttää kahvinvalmistuksen, painamalla lyhyesti aiemmin painamaasi painiketta "1 kuppi"  tai "2 kuppia" , tai kääntämällä kiertonuppia "kuppikoko" (kuva 12) vastapäivään suuntaan "Espressokuppi".





Voit suurentaa kahvimäärää heti kahvin valumisen loputtua pitämällä "1 kuppi"  / "2 kuppia"  -painiketta painettuna, kunnes haluttu kahvimäärä on saavutettu tai kiertämällä kiertovalitsinta "Kuppikoko" (kuva 12) myötäpäivään "Muki"-suuntaan (tee se välittömästi kahvin valumisen päätyttyä, ennen kuin käytetty kahvijauhe tyhjenetään sakkasäiliöön).

Laite on jälleen valmis käytettäväksi parin sekunnin kuluttua, kun symbolin "1 kuppi"  tai "2 kuppia"  valo sammuu. Voit silloin valmistaa seuraavan kahvisi.



Jos kahvi valmistuu tippumalla tai ei ollenkaan tahi, jos kahvi tulee liian nopeasti ja vaahtokruunu ei ole haluamasi, tulisi sinun muuttaa jauhatustasetta. Katso „Jauhatustaseen asetus" Sivu 196



Kun symbolien  ja  valot vilkkuvat, kahvijauhe on jauhettu liian hienoksi. Jos haluat muuttaa jauhatustaseen asetusta, katso „Jauhatustaseen asetus" Sivu 196.



Kun symbolin  valo palaa, on vesisäiliöön lisättävä vettä, sillä laite ei muuten voi valmistaa kahvia. (On normaalia, että vesisäiliössä kuitenkin vielä on vähän vettä, kun symboli tulee näkyviin).



Kun symbolin  valo palaa, sakkasäiliö on täynnä. Säiliö on tyhjennettävä ja puhdistettava, katso „Hylkykahviastian tyhjennys" Sivu 198. Symbolin valo palaa, kunnes sakkasäiliö on puhdistettu, eikä kahvinkeittimellä voi sitä ennen valmistaa kahvia.



Älä koskaan poista vesisäiliötä kahvinvalmistuksen aikana. Jos vesisäiliö irrotetaan ei kahvinkeitin enää voi valmistaa kahvia. Ilmaa kahvinkeitin kääntämällä höyryn ja kuumaveden kiertonuppi mahdollisimman pitkälle vastapäivään, asentoon , ja anna veden valua muutama sekunti höyrysuuttimesta.



**i** KahvinkeitTIMEN ensimmäisessä käyttöönotossa tulisi sinun valmistaa vähintään 4–5 kahvia, ennen kuin keitin saavuttaa hyväksyttävän tuloksen.

### 6.1 Vihje kuumemman kahvin valmistuksesta:

- Jos tahdot valmistaa pienen kupin kahvia (alle 60 ml) heti sen jälkeen, kun kahvinkeitin on kytketty päälle, tulisi sinun käyttää huuhteluvaiheen kuumaa vettä kuppien lämmittämiseen.
- Aseta vastaavassa valikossa kahvin lämpötila suuremmalle arvolle, katso „Kahvin lämpötilan asettaminen” Sivun 197.
- Älä käytä liian paksuja kuppeja, paitsi jos lämmität niitä etukäteen, koska ne absorboivat liikaa lämpöä.
- Käytä esilämmitettyjä kuppeja, huuhtelemalla ne kuumalla vedellä tai pitämällä ne vähintään 20 minuuttia kytketyn kahvinkeitTIMEN kuumennetulla kuppilustalla.

## 7 Usean kahvikupillisen valmistus kannutoimintoa käyttäen

Tämän toiminnon avulla voit täysautomaattisesti valmistaa useita kuppeja kahvia suoraan toimitukseen kuuluvaan jaloteräksiseen termoskannuun: Jauhaminen, annostelu, puristus, kahvijauheen kostutus, kahvin valmistaminen ja kahvinporojen poisto edellisessä kappaleessa selostetulla tavalla.

- ☞** Kierrä toimitukseen kuuluvan jaloterästermoskannun kansi poistoasentoon (kuva 16) ja nosta kansi pois. Huuhtele kannu ja kansi.
- ☞** Aseta termoskannun kansi kaatoasentoon (kuva 17) ja aseta kannu kahviputken alle (D). Kahviputken tulee olla työnnettynä yläasentoonsa, jotta termoskannua voidaan työntää paikoilleen.

Yksi kannutoimintojen symbolien valoista palaa riippuen siitä, kuinka

monta kuppia valittiin kannutoiminnon edellisen käytön yhteydessä. Sen lisäksi symbolien "<" ja ">" valot palavat.

Kannuun valmistettavien kupillisten lukumäärä näytetään seuraavasti:

 4 kupillista

 6 kupillista

 8 kupillista

 10 kupillista

- ☞** Varmista, että vesisäiliö on täynnä, papusäiliössä on riittävästi kahvipapuja ja sakkasäiliö on tyhjä, jotta haluamasi kahvimäärän valmistus olisi mahdollista.

**i** Jos haluat muuttaa kahvin vahvuutta ja kannutoiminnon täyttömäärää, käytä kiertovalitsinta "Kuppikoko" (kuva 12) / kiertovalitsinta "Kahvin vahvuus" (kuva 13) kohdassa „Kahvin valmistaminen kahvipavuista” Sivun 191 kuvatulla tavalla.

- ☞** Valitse tarvittaessa selauspainikkeella "<" tai ">" symboli sen mukaan, kuinka monta kupillista kahvia haluat valmistaa kannuun (esim.  8 kupilliseksi).

- ☞** Paina "Kannu"-painiketta  (kuva 18).

Valitun kuppimäärän kannusymbolin valo vilkkuu kahvin valmistuksen aikana.

Kun kahvin keittäminen on päättynyt, kaikkien kannusymbolien valot vilkkuvat vuorotellen. Valitun kuppimäärän symbolin valo palaa kuitenkin kaksi kertaa niin kauan kuin muiden symbolien valot.

- ☞** Poista nyt termoskannu ja sulje kansi (kuva 19), jotta kahvi pysyisi kuumana pitkään.

Laite palaa automaattisesti takaisin kahvin valmistuksen toimintamuotoon.

- i** Jos laitteeseen on täytetty liian vähän kahvipapuja tai vesisäiliössä on liian vähän vettä halutun ohjelman toteuttamiseksi tai sakkasäiliö on täynnä, laite keskeyttää valmistuksen ja käyn-

FIN

nissä oleva ohjelma pysähtyy. Vian korjauksen jälkeen on ohjelma käynnistettävä uudelleen. Tällöin on kahvimäärä, joka jo on kannussa otettava huomioon, jotta ei kannuun tulisi liikaa kahvia.

-  Kun symbolien ☰ ja ▲ valot vilkkuvat, kahvijauhe on jauhettu liian hienoksi. Jos haluat muuttaa jauhatusasteen asetusta, katso „Jauhatusasteen asetus“ Sivu 196.

## 8 Kahvin valmistaminen kahvijauheesta

Tämän toiminnon avulla voit valmistaa kahvia valmiiksi jauhetusta kahvijauheesta (esim. **kofeiiniton kahvi**).

-  Huom! Varmista, että täyttöaukkoon ei ole jäänyt kahvijauhetta eikä sinne pääse mitään ylimääräistä. Täyttöaukossa ei voi varastoida kahvijauhetta, vaan jauheen on aina mentävä suoraan laitteeseen.

-  Kierrä kiertonuppi "Kahvin voimakkuus / esijauhettu kahvi" (kuva 20) haluttuun asentoon ☞ (1 kupillista varten) tai ☞☞ (2 kupillista varten), valitaksesi esijauhetun kahvijauheen toiminnon. Täten kahvimylly poistuu käytöstä. Symbolin ☞ (1 kupillinen) valo tai kummankin symbolin ☞☞ (2 kupillista) valot palavat.

-  Avaa kahvijauheen täyttöaukon kansi ja laita sinne tuoretta kahvijauhetta (kuva 21).

Käytä vain toimitukseen kuuluvaa mittalusikkaa. Älä koskaan täytä enempää kuin kahta tasapäistä mittalusikallista, sillä muuten laite ei valmista kahvia, kahvijauhe leviää laitteeseen ja likaa sen tai kahvia tulee vain tipoittain ja symbolien ☰ ja ▲ valot vilkkuvat. Älä täytä kahvijauhetta kahvin valmistuksen ollessa käynnissä. Laita kahvijauhetta seuraavaa kupillista varten vasta, kun kahvi on valmista ja laite on jälleen valmis käytettäväksi. Älä koskaan täytä kahvijauhetta poiskytket-

tyyn koneeseen, koska se leviää koneen sisällä.

-  Käytä vain täysautomaattisiin espressokoneisiin tarkoitettua kahvijauhetta. Älä täytä täyttöaukkoon kahvipapuja, veteen liukenevia, pakastekuivattuja pikakahvijauheita tai muita juomajauheita. Liian hienoksi jauhettu kahvijauhe voi johtaa tukoksiin.

-  Jos täyttöaukko on tukossa (johtuen laitteen kosteudesta, tai koska olet täyttänyt enemmän kuin 2 mittalusikallista kahvijauhetta) voit käyttää veistä tai lusikan vartta jauheen työntämiseksi alas (kuva 22). Poista sitten vedenkuumennusyksikkö ja puhdistista yhdessä kahvinkeitin kanssa kohdan „Vedenkuumennusyksikön puhdistus“ Sivun 198 mukaisesti.

-  Sulje kansi.

-  Valitse haluamasi kuppikoko kiertovalitsimella "Kuppikoko" (kuva 12) kohdassa „Kahvin valmistaminen kahvipavuista“ Sivun 191 kuvatulla tavalla.













-  Paina painiketta "1 kuppi kahvia" ☐ yhden kahvikupillisen valmistusta varten tai painiketta "2 kuppia" ☐☐ kahta kupillista varten.  
Kahvi valmistetaan.

-  Jos valittiin 1 kupillisen valmistaminen valmiiksi jauhetusta kahvijauheesta eikä kahvijauhetta täytetty laitteeseen, symbolien ☞ ja ▲ valot alkavat vilkkua painikkeen ☐ painamisen jälkeen. Jos valittiin 2 kupillisen valmistaminen valmiiksi jauhetusta kahvijauheesta eikä kahvijauhetta täytetty laitteeseen, symbolien ☞☞ ja ▲ valot alkavat vilkkua painikkeen ☐☐ painamisen jälkeen.

-  Jotta kahvin valmistuksen jälkeen taas pääsisi kahvipaputilaan, tulee sinun kiertää kiertonuppiä "Kahvin voimakkuus / jauhattu kahvi" (kuva 20) mie-livaltaiseen kahvin voimakkuusasentoon (kahvimyllyn käyttö on jälleen mahdollista).



## 9 Maidon vaahdottaminen

Höyryä voidaan käyttää sekä maidon vaahdottamiseen että nesteiden kuumentamiseen. Laite on varustettu erillisellä höyrytystoiminnolla, koska höyrytys vaatii korkeampaa lämpötilaa kuin kahvin valmistus.

-  Valmista annos cappuccinoa laittamalla isoon kuppiin puoliksi tai 2/3 espresso ja lisäämällä siihen lopuksi vaahdotettu maito.
-  **Huom!** Toimiva höyrysuutin voi aiheuttaa palovammoja! Laitteesta ulos tuleva kuuma vesi / kuuma vesihöyry voi johtaa palovammoihin. Käynnistä höyrykehitys sen takia vasta, kun höyryputki on upotettu maitoon.
-  Paina höyrymuodostusta varten painiketta "Höyry" (kuva 23.).  
Symbolin  valo palaa ja laite lämpee. Symbolin  valo vilkkuu lämmityksen ajan.  
Kun lämmitysvaihe on päättynyt, symbolin  valo palaa jatkuvasti. Laite on valmis maidon vaahdottamiseen.
-  Jos höyrytoiminto on yli 2 minuuttia käyttämättä, laite kytkeytyy automaattisesti takaisin kahvinvalmistustoimintoon.
-  Välttääkseen, että vaahdottamisessa tulee jäännösvettä maitoon, tulisi vesi ensin laskea pois. Pidä astiaa höyrysuuttimen alapuolella ja käännä höyryn ja kuuman veden kierrenuppi (kuva 10) niin kauan asentoon  kunnes purkautuu vain höyryä. Kierrä sitten nuppi takaisin asentoon .
-  Kaada vähärasvaista, kylmää maitoa kuppiin, jonka on mahdollista laitteen höyryputken alle.
-  Maidon pitää olla tarpeeksi kylmää. Vaahdotus onnistuu parhaiten, jos käytät kylmää, mieluiten ruostumattomasta teräksestä valmistettua mukia, jota et huuhtele ennen käyttöä lämpimällä vedellä.



 Käännä höyrysuutinta ulospäin ja aseta putken alle muki siten, että putki uppoaa vähän maitoon (kuva 24).

 **Huom!** On olemassa vaara, että höyrysuuttimeen kuivuva maito aiheuttaa epäpuhtauksia. Älä upota höyrysuutinta maitoon niin syväälle, että putken yläosassa oleva ilma-aukko on maidossa. Maitoa voi sitä kautta imeytyä suuttimeen ja aiheuttaa höyrysuuttimeen epäpuhtauksia.

 Käännä höyryn ja kuuman veden kierrenuppi (kuva 10) asentoon .

 Saadaksesi kuohkeamman maitovaahdon, tulee sinun liikuttaa astiaa hitaasti alhaalta ylöspäin. Vaahdota maito vähintään kaksinkertaiseen tilavuuteen.



 Höyryn muodostusta ei suositella yli 2 minuutin ajan.

 Päättää vaahdotus kääntämällä höyryn ja kuuman veden kiertovalitsin (kuva 10) asentoon  ja ota astia pois.



 **Huom!** Varo polttamasta itseäsi roiskuvalla kuumalla maidolla! Kytke höyry pois toiminnasta, ennen kuin otat astian pois, jossa on vaahdotettu maito.

 Poistu höyrytystilasta painamalla painiketta "Höyry" (kuva 23) tai odota n. 120 sekuntia, kunnes laite siirtyy automaattisesti takaisin kahvinvalmistustilaan.

Laite on nyt jälleen valmis kahvin valmistusta varten.

 Kun olet vaahdottanut maitoa, huuhtele aina höyrysuuttimen lävitse vähän aikaa kuumaa vettä kääntämällä höyryn ja kuuman veden kiertovalitsin (kuva 10) asentoon .







Näin on ehdottomasti tehtävä, jotta maitojäännökset eivät pääsisi kuivumaan suuttimen sisään ja näin tukkiimaan sitä. Aseta putken alle sopiva astia puhdistuksen ajaksi. Symbolin  palaa tämän vaiheen aikana.

 Aseta höyryn ja kuuman veden kiertonuppi sen jälkeen takaisin asentoon ; näyttöön tulee viimeksi valittu kahvia-asetus.

FIN





### 9.1 Höyrysuuttimen puhdistus

**Tärkeää:** Hygieenisistä syistä suosittelemme suorittamaan seuraavaksi selostettu toiminta joka kerta maidon vaahdotuksen jälkeen. Näin vältät maidon tarttumisen höyrysuuttimen sisälle.

-  Käännä höyryn ja kuuman veden kiertonuppi myötäpäivään vasteeseen asti asentoon ●. Odota pari minuuttia, kunnes höyrysuutin on jäähtynyt.
-  Tartu kääntöputken mustaan kahvaan ja avaa höyrysuuttimen pikalukitus kiertämällä sitä vähän myötäpäivään. Vedä höyrysuutin alaspäin (kuva 25).
-  Vedä höyrysuuttimen sisäosa alaspäin, irti kääntöputkesta.
-  Puhdista höyrysuutin ja sisäosa lämpimällä vedellä.
-  Tarkista, ettei kuvassa 26 merkityt reiät ole tukossa. Työnnä tarvittaessa neula niiden läpi ja puhdista ne.
-  Asenna sisäosa takaisin, työntämällä se varovasti kääntöputkeen.
-  Asenna höyrysuutin takaisin, työntämällä se paikoilleen ja kiertämällä sitä vastapäivään.

## 10 Kuuman veden valmistaminen

Kuumaa vettä voidaan käyttää kuppien lämmittämiseen ja kuumien juomien valmistamiseen (esim. tee tai pussikeitot).

-  **Huom!** Toiminnassa oleva kuumavesiputki voi aikaansaada palovammoja! Putkesta tuleva kuuma vesi voi aiheuttaa palovammoja. Käynnistä veden kuumennus vain, kun kuumavesiputken alla on astia.
-  Aseta kuumavesiputken alle astia.
-  Käännä höyryn ja kuuman veden kiertonuppi asentoon ☺☼ (kuva 10). Kuumaa vettä valuu astiaan; symbolin ☼ valo palaa.
-  Kuuman veden jatkuvaa muodostusta ei suositella yli 2 minuutin ajan.

-  Käännä kuuman veden valmistuksen jälkeen höyryn ja kuuman veden kiertonuppi takaisin asentoon ● (kuva 10) ja poista astia.

## 11 Jauhatusasteen asetus

Mylly on tehtaalla asetettu keskikarkealle jauhatukselle. Jos kahvin valmistus on joko liian nopeaa tai liian hidasta (tiputtaen), voit muuttaa jauhatusasteen jauhatuksen aikana.

-  **Jauhatusastetta saa säätää vain jauhatuksen aikana. Jauhatusasteen asetuksen nuppia (kuva 2, T ja kuva 27) saa siis kiertää vain, kun mylly jauhaa kahvipapuja kahvin valmistusta varten. Säätöjen tekeminen kahvimyllyn ollessa pysähdyksissä voi vaurioittaa laitetta.**

-  Säädä jauhatusastetta jauhamisen aikana jauhatusasteen säätönupilla (kuva 2, T) (kuva 27).
  - Jos kahvia tulee ulos tipoitain tai ei ollenkaan (symbolien ☺ ja ☼ valot saattavat palaa), kierrä nuppia yksi askel myötäpäivään. Kierrä aina yksi askel kerrallaan, kunnes kahvin valmistus on tyydyttävä.
  - Jos kahvi valmistuu liian nopeasti, eikä vaahtokruunun maku miellytä sinua, kierrät nuppia yhden askeleen vastapäivään.

-  Varmista, ettet kierrä jauhatuksen säätönuppia liian pitkälle, koska se voi johtaa tipoitaiseen kahvin valmistukseen valmistettaessa 2 kupillista.

-  Näiden säätöjen vaikutuksen huomaat vasta vähintään kahden kahvin valmistuksen jälkeen.

















### Vierasosien poistaminen myllystä

Kahvimyllyyn joutuneet vierasosat (esim. kivet) voivat vaurioittaa myllyä. Kahvissa oleva vieras esine aiheuttaa tasaisen äänekkään kolkutuksen. Jos kuulet tämän äänen jauhatuksen aikana, katkaise laitteesta välittömästi virta ja ota yhteys asiakaspalveluun.

Myllyyn joutuneista vieraista aineista aiheutuva tukkeutuminen tai vioittuminen ei saata kuulua takuun piiriin.

## 12 Kahvin lämpötilan asettaminen











Voit valita kolmesta eri lämpötilasta. Tehtaalla suoritettu asetus on "Lämpötila korkea". Voit muuttaa lämpötilan seuraavasti:

-  Paina valikkopainiketta "P" (kuva 4).. Symbolien "P" ja  valot syttyvät. Sen lisäksi painikkeiden ,  ja , yläpuolella olevan 3 pienen symbolin valot syttyvät ilmoittamaan painikkeiden sen hetkisen toiminnon, katso „Erikoistoiminto” Sivu 189.
-  Paina selauspainiketta "<" tai ">" (kuva 5) niin usein, että symbolin  valo syttyy.
-  Vahvista valikon kohta painikkeella "OK" (kuva 5). Näyttö ilmoittaa sen hetkisen asetuksen. Lämpötilat näytetään seuraavasti:
  -  Lämpötila matala
  -  Lämpötila keskikorkea
  -  Lämpötila korkea
-  Valitse tarvittaessa toinen lämpötila selauspainikkeella "<" tai ">" (kuva 5).
-  Kun valitsemasi lämpötila näkyy näyttössä, vahvistat valinnan painikkeella "OK"(kuva 5). Lämpötila on näin ohjelmoitu.
-  Kun haluat keskeyttää toiminnon asetusta tallentamatta, paina "P"-painiketta "OK"-painikkeen asemasta.
-  Ellei painiketta „OK" paineta, siirtyy laite n. 120 s kuluttua automaattisesti takaisin kahvin valmistuksen toimintamuotoon, tallentamatta syöttöjä.
-  Palaa kahvin valmistuksen toimintamuotoon painamalla lopussa painiketta "P" (kuva 4) tai odota n. 120 sekuntia, kunnes laite siirtyy sinne automaattisesti.

## 13 Puhdistus ja hoito

Laite valmistaa aina laadukasta kahvia ja toimii häiriöttä, kun huolehdit laitteen puhtaudesta.

### 13.1 Säännöllinen puhdistus

-  **Huom!** Katkaise laitteesta virta ennen puhdistusta. Anna laitteen jäähtyä.
-  **Huom!** Älä koskaan puhdistu laitetta tai sen yksittäisiä osia astianpesukoneessa. Älä koskaan upota kahvinkeitintä veteen.
-  **Huom!** Älä koskaan laita papusäiliöön vettä, sillä vesi vaurioittaa myllyä.
-  Vältä naarmuttavien, hankaavien tai syövyttävien aineiden käyttöä. Pyyhi runko ulkoa ja sisältä vain kostealla liinalla.
-  Ota vesisäiliö (kuva 6) joka päivä pois laitteesta ja kaada siihen jäänyt vesi pois. Huuhtelee vesisäiliö aina puhtaalla vedellä. Täytä säiliöön joka päivä rai-kasta vettä.
-  Tyhjennä hylkykahviastia päivittäin tai viimeistään näyttötekstin näin vaati-essa, katso „Hylkykahviastian tyhjennys" Sivu 198.
-  Tyhjennä valumisastia säännöllisesti. Tyhjennä valumisastia viimeistään, kun valumisastiassa oleva punainen uimuri (kuva 28) ilmestyy näkyviin valumisriti-län aukkoon.
-  Puhdista vesisäiliö (N), valumisastia (O), valumisritilä (A) ja hylkykahviastia (Q) säännöllisesti, vähintään kerran vii-kossa lämpimällä vedellä, miedolla astianpesuaineella ja tarvittaessa pens-selillä.
-  Ota höyrysuutin irti jokaisen vaahdo-tuksen jälkeen ja puhdista se huolelli-sesti maitojäännöksistä, katso „Höyrysuuttimen puhdistus" Sivu 196.
-  Tarkista, ettei kahviputken aukot ole tukossa. Voit puhdistaa poistamalla kuivunut kahvi neulalla (kuva 29).

FIN

### 13.2 Hylkykahviastian tyhjennys

Laitte laskee valmistettujen kahviannosten määrän. 14 yksittäisen (tai 7 parittain) valmistetun kahvin jälkeen symbolin ☒ valo syttyy ilmoittamaan, että sakkasäiliö on täynnä. Säiliö on tyhjennettävä ja puhdistettava. Kahvinkeitin ei voi valmistaa kahvia, ennen kuin sakkasäiliö on puhdistettu.

- ☞ Avaa puhdistusta varten huoltoluukku painamalla vastaavaa avauspainiketta (kuva 30), symbolin ☐ valo syttyy.
- ☞ Ota valumisastia pois (kuva 31). Tyhjennä ja puhdista se.
- ☞ Tyhjennä ja puhdista hylkykahviastia perusteellisesti. Varmista, että kaikki pohjaan kerrostuneet jäännökset poistetaan.

**Tärkeää:** Joka kerta, kun vedät ulos tippumaljan täytyy myös hylkykahviastia y' tyhjentää, vaikkei se olisikaan täynnä. Ellei tätä toimenpidettä suoriteta, saattaa hylkykahviastia ylitäyttyä seuraavissa kahvinvalmistuksissa, ja ylitäytetty kahviporo voi tukkia kahvinkeitin.

- ☺ Kun olet ottanut valumisastian pois, symbolin ☒ valo vilkkuu.
- ☺ Hylkykahviastia kannattaa puhdistaa laitteen päivittäisen käytön yhteydessä joka päivä. Tyhjennä hylkykahviastia aina, kun laitteen virta on kytkettynä. Vain silloin laite tunnistaa tyhjennyksen.

### 13.3 Myllyn puhdistus

Kahvijauhejäännökset voidaan poistaa papusäiliöstä pehmeällä pensselillä tai pölynimurilla.

- ⚠ Huom! Älä koskaan kaada myllyyn vettä, sillä vesi vaurioittaa sitä.
- ☞ Katkaise laitteen virta virtakytkimellä (kuva 11) ja pääkytkimellä (kuva 8). Vedä pistoke pois pistorasiasta.
- ☞ Poista säiliöön jääneet kahvipavut (esim. imurin letkulla tai rakosuulakkeella).

- ☺ Jos vieraan esineen poistaminen ei ole mahdollista, on käännettävä asiakaspalvelun puoleen. **Myllyyn joutu-neista vieraista aineista aiheutuva tukkeutuminen tai vioittuminen ei saata kuulua takuun piiriin.**

- ⚠ **Huom!** Pyörivä mylly voi johtaa loukkaantumisiin. Älä koskaan kytke laitteeseen virtaa, kun puhdistat myllyä. Se voi johtaa vakaviin loukkaantumisiin. Vedä pistoke ehdottomasti pistorasiasta.

- ☞ Testaa myllyn toiminta pienellä määrällä kahvipapuja ja valmista kupilinen kahvia. Ensimmäisen jauhamisen tai puhdistuksen jälkeen vedenkuumennusyksikköön menee vähemmän kahvijauhetta, koska kanava on täytetty. Se voi vaikuttaa ensimmäisen kahvin makuun.

### 13.4 Vedenkuumennusyksikön puhdistus

Suosittellemme vedenkuumennusyksikön puhdistusta (riippuen käyttöasteesta) säännöllisesti. Hylkykahviastia ja vesisäiliö on tyhjennettävä ja laite sekä vedenkuumennusyksikkö on puhdistettava huolellisesti, ennen kuin laite otetaan pois käytöstä pitemmäksi ajaksi (esim. loma).

Menettele seuraavasti:

- ☞ Katkaise virta kahvinkeitimestä painamalla virtakytkintä (kuva 11) (älä irrota pistoketta pistorasiasta) ja odota, kunnes kaikkien symbolien valot sammuvat!
- ☞ Avaa huoltoluukku painamalla kyseistä avauspainiketta (kuva 30).
- ☞ Irrota tippumalja ja hylkykahviastia (kuva 31) ja puhdista ne.
- ☞ Paina vedenkuumennusyksikön kahta sivuttaista punaista vapautuspainiketta keskiosan suuntaan (kuva 32) ja irrota vedenkuumennusyksikkö.
- ☺ **Huom!:** Vedenkuumennusyksikkö voidaan irrottaa vain, jos laite on sammutettu laitteen etusivussa olevalla virtakytkimellä ①. Laitetta ei tule

irrottaa sähköverkosta. Jos koetat irrottaa vedenkuumennusyksikön kahvinkeitinissä ollessa kytkettynä, saattaa se vaurioitua vakavasti.

 Puhdista vedenkuumennusyksikkö juoksevassa vesijohtovedessä, astianpesuainetta käyttämättä. Älä pese vedenkuumennusyksikköä astianpesukoneessa.

 Puhdista koneen sisäosat perusteellisesti. Kaavi irti kahvinkeitinissä olevat kahvikarstaantumiset puu- tai muovihaarukalla tai vastaavalla, joka ei naarmuta pintaa, (kuva 33) ja ime sitten pois kaikki jäännökset pölynimurilla (kuva 34).

 Asenna vedenkuumennusyksikkö takaisin (kuva 36, a) työntämällä se pitiimeen (kuva 36, b) ja tappiin (kuva 36, c). Tapin tulee asettua vedenkuumennusyksikön alla olevaan putkeen (kuva 36, d).

 Paina tiukasti tekstiä PUSH (kuva 36, e), kunnes vedenkuumennusyksikkö lukkiutuu kuuluvasti paikoilleen.

 Varmista, kuultuasi lukkiutumisäänen, että punaiset painikkeet (kuva 36, f) ovat ponnahtaneet ulos, muutoin ei huoltoluukku voida sulkea.

kuva 37: Molemmat punaiset painikkeet ovat ponnahtaneet ulos oikealla tavalla.

kuva 38: Molemmat punaiset painikkeet eivät ole ponnahtaneet ulos.

 Asenna tippumalja ja hylkykahviastia yhdessä paikoilleen.

 Sulje huoltoluukku.

 Jos vedenkuumennusyksikkö ei ole oikein asennettu, t.s., kunnes kuuluva lukkiutuminen tapahtuu, eivätkä punaiset painikkeet ole ponnahtaneet oikein ulos, ei huoltoluukku pysty sulkemaan.

 Jos vedenkuumennusyksikön asennus on vaikeaa, tulee se (ennen asennusta) saattaa oikealle korkeudelle, painamalla vedenkuumennusyksikköä yhteen samanaikaisesti alta ja ylhäältä, kuvan 35 osoittamalla tavalla.

 Jos vedenkuumennusyksikön asennus edelleen on vaikeaa, sulje huoltoluukku, irrota verkkojohdon pistoke pistorasiasta ja liitä se sitten uudelleen. Odota, kunnes kaikkien symbolien valot ovat sammuneet, avaa sitten huoltoluukku ja asenna vedenkuumennusyksikkö takaisin.

### 13.5 Kalkinpoisto-ohjelman suoritus





Kalkinpoisto-ohjelman ansiosta laitteen kertynyt kalkki saadaan poistettua helposti ja tehokkaasti. Kun symbolin  valo syttyy, on laitteeseen kertynyt kalkki poistettava.



 **Huom!:** Älä missään tapauksessa käytä mitään kalkinpoistoainetta, jota AEG/Electrolux ei suosittele. AEG/Electrolux ei korvaa muiden kalkinpoistoaineiden käytöstä mahdollisesti aiheutuvia vahinkoja. Kalkinpoistonestettä saat alan liikkeistä tai AEG/Electrolux huoltopalvelusta.



 Kalkinpoisto kestää 45 minuuttia eikä sitä saa keskeyttää. Sähkökatkoksen sattuessa on ohjelma käynnistettävä uudelleen.



 Puhdista vedenkuumennusyksikkö ennen kalkinpoisto-ohjelman käynnistämistä (katso „Vedenkuumennusyksikön puhdistus“ Sivu 198).

 Paina painiketta "P" (kuva 4).

Symbolien "P" ja  valot syttyvät. Sen lisäksi painikkeiden  ja  ja  yläpuolella olevan 3 pienen symbolin valot syttyvät ilmoittamaan painikkeiden sen hetkisen toiminnon, katso „Erikoistoiminto“ Sivu 189.

 Paina selauspainiketta "<" tai ">" (kuva 5) niin usein, että symbolin  valo syttyy.

 Vahvasta "OK"-painikkeella (kuva 5). Symbolien  ja  valot vilkkuvat ja "P"-painikkeen valo palaa yhtäjaksoisesti.

 Kun haluat keskeyttää kalkinpoisto-ohjelman tässä kohdassa, kytke laite pois päältä virtakytkimellä  (kuva 11).



FIN

 Tyhjennä vesisäiliö, täytä siihen vähintään 1 litra vettä ja lisää kalkinpoistoaine.



 **Huom!** Varmista, että kalkinpoistoaineen mahdolliset roiskeet eivät joudu hapolle herkille pinnoille, kuten marmori, kalkkikivi tai keramiikka.



 Aseta vähintään 1,5 litran astia höyrysuuttimen alle (kuva 9)

 Aseta höyryn ja kuumaveden kierto-nappi asentoon .

Kalkinpoisto-ohjelma käynnistyy ja kalkinpoistoneste valuu höyrysuuttimesta. Symbolien ,  ja "P" valot palavat jatkuvasti.

Kalkinpoisto-ohjelma suorittaa automaattisesti sarjan huuhteluja ja taukoja, poistaakseen kalkkikerrostumat kahvinkeitin sisältä.



Vesisäiliö on tyhjä noin 30 minuutin kuluttua, symbolien  ja  valot vilkkuvat ja "P"-painikkeen valo palaa yhtäjaksoisesti.



 Käännä höyryn ja kuumaveden kierto-nappi takaisin asentoon .



Laitte on nyt valmis puhtaalla vedellä huuhtelua varten.



 Vedä vesisäiliö ulos, täytä se raikkaalla vedellä ja laita takaisin paikoilleen.

 Tyhjennä höyrysuuttimen alla oleva astia ja aseta se takaisin höyrysuuttimen alle.

 Aseta höyryn ja kuumaveden kierto-nappi asentoon .

Laitte suorittaa huuhtelun puhtaalla vedellä ja huuhteluvesi valuu höyrysuuttimesta. Symbolien ,  ja "P" valot palavat jatkuvasti.

Vesisäiliö on tyhjä muutaman minuutin kuluttua, symbolien  ja  Vesisäiliö on tyhjä muutaman minuutin kuluttua, symbolien.

 Käännä höyryn ja kuumaveden kierto-nappi takaisin asentoon .

Viimeksi valitun kahvin valmistuksen toimintamuodon symbolit tulevat näkyviin ja symbolin  valo palaa yhtäjaksoisesti.

 Tyhjennä huuhteluvesiastia.

 Vedä vesisäiliö ulos, täytä se raikkaalla vedellä ja laita takaisin paikoilleen.

Laitte on nyt jälleen valmis käytettäväksi ja toimii viimeiseksi valitulla kahvinvalmistusasetuksella.

 Suosittelemme heittäämään kalkinpuhdistusohjelman jälkeen valmistetun ensimmäisen kahvikupillisen pois.

## 14 Lisävarusteiden tilaaminen

Laitteen säännöllinen puhdistus ja kalkinpoisto on hyvin tärkeää laitteen moitteettoman toiminnan takaamiseksi ja ennenaikaisten vikojen välttämiseksi. Voit tilata alkuperäisiä puhdistustabletteja ja kalkinpoistoaineita suoraan meiltä.

Saksassa voit soittaa numeroon:

1801 - 20 30 60\*

(\*Paikallispuhelumuksu Deutschen Telekom kiinteästä verkosta)  
maanantaista perjantaihin klo 8.00 - 18.00

## 15 Mitä tulisi tehdä, jos näyttöön tulee seuraava viesti...



**Symbolin  valo palaa yhtäjaksoisesti**

- Vesisäiliö on tyhjä tai väärin asennettu.



 Säiliön täyttö ja ohjeidenmukainen asennus, katso „Vesisäiliön täyttäminen” Sivu 189.

- Vesisäiliö on likainen, tai siihen on muodostunut kalkkikerrostumista.

 Huuhtele vesisäiliö tai suorita kalkinpoisto.

**Symbolien  ja  valot vilkkuvat**

- Kahvinkeitin ei pysty valmistamaan kahvia.

 Aseta astia höyrysuuttimen alle ja kierrä höyryn ja kuumaveden kierto-nappi vastapäivään asentoon  (kuva 9).



- Kahvi valuu ulos liian hitaasti.
- ☞ Kierrä jauhatusasteen säätönappia (kuva 12) yhden askeleen verran myötäpäivään silloin, kun mylly jauhaa kahvipapuja kahvin valmistusta varten (katso „Jauhatusasteen asetus“ Sivu 196).

#### Symbolin ☒ valo palaa yhtäjaksoisesti

- Hylkykahviastia on täynnä:
- ☞ Tyhjennä hylkykahviastia kohdassa „Hylkykahviastian tyhjennys“ Sivu 198 selostetulla tavalla, puhdista ja asenna se oikein takaisin.

#### Symbolin ☒ valo vilkkuu

- Hylkykahviastiaa ei ole asetettu paikalleen puhdistuksen jälkeen.
- ☞ Avaa huoltoluukku ja aseta hylkykahviastia paikalleen.

#### Symbolin ☞ tai ☞☞ ja △ valo vilkkuu

- Esijauhatus kahvitoiminnon valinnan jälkeen ei kahvijauhetta ole laitettu täyttöaukkoon.
- ☞ Täytä kahvijauhetta kohdassa „Kahvin valmistaminen kahvijauheesta“ Sivu 194 selostetulla tavalla.

#### Kaikkien kahvin vahvuuden symbolien ☞☞☞☞ ja △ valot vilkkuvat

- Kahvipapusailiössä ei enää ole kahvipapuja.
- ☞ Säiliön täyttö, katso „Kahvipapusailiön täyttäminen“ Sivu 189.
- Jos mylly tulee hyvin kovaääniseksi, saattaa se johtua siitä, että kahvipapujen joukossa ollut pieni kivi on lukinnut myllyn.
- ☞ Ota yhteyttä asiakaspalveluun. Myllyn joutuneista vieraista aineista aiheutuva tukkeutuminen tai vioittuminen ei saata kuulua takuun piiriin.

#### Symbolin ☒ valo palaa yhtäjaksoisesti

- Osoittaa, että kahvinkeittimeen on karstaantunut kalkkia.
- ☞ Luvussa „Kalkinpoisto-ohjelman suoritus“ Sivu 199 selostettu kalkinpoisto-ohjelma tulee suorittaa mahdollisimman nopeasti.

#### Symbolin ☐ valo palaa yhtäjaksoisesti

- Huoltoluukku on auki.
- ☞ Sulje huoltoluukku. Ellei huoltoluukku pysty sulkemaan, tulee sinun tarkistaa, että vedenkuumennusyksikkö on asennettu oikein (katso „Vedenkuumennusyksikön puhdistus“ Sivu 198)

#### Symbolin △ valo vilkkuu

- Todennäköisesti on puhdistuksen jälkeen unohdettu asentaa vedenkuumennusyksikkö takaisin kahvinkeittimeen.
- ☞ Asenna vedenkuumennusyksikkö, katso „Vedenkuumennusyksikön puhdistus“ Sivu 198
- Kone on sisältä erittäin likainen.
- ☞ Puhdista koneen sisäosat perusteellisesti, katso „Vedenkuumennusyksikön puhdistus“ Sivu 198. Jos kahvinkeittimeen näytössä edelleen on sama viesti suoritettua puhdistusta jälkeen, on otettava yhteyttä asiakaspalveluun.

#### Symbolin △ valo palaa jatkuvasti

- Kyse on yleisluontoisesta hälytyksestä.
- ☞ Ota yhteyttä huoltopalveluun.

#### Symbolien ☒ ja △ valot vilkkuvat

- Laitteeseen on kytketty virta höyryn ja kuumun veden kiertovalitsimen ollessa asennossa "auki" ☞☒.
- ☞ Käännä höyryn ja kuumun veden kiertovalitsinta myötäpäivään (kuva 10) perille saakka asentoon ●.

#### Symbolien ☒ ja △ valot vilkkuvat

- Ympäristön lämpötila on liian alhainen laitteen käyttöä varten.
- ☞ Käytä laitetta lämpimämmässä paikassa.

FIN

## 16 Ratkaistavat ongelmat, ennen kuin soitat asiakaspalveluun

Jos kahvinkeitin ei toimi, voit helposti löytää toimintahäiriön syyn ja korjata se, etsimällä apua kohdasta „Mitä tulisi tehdä, jos näyttöön tulee seuraava viesti...“ Sivun 200. Jos kahvinkeitinmessä ei näy mitään symbolia, tee seuraavat tarkistukset, ennen kuin otat yhteyttä huoltopalveluun.

### Kahvi ei ole kuumaa

- Kuppeja ei ole lämmitetty etukäteen.
- ☞ Käytä esilämmitettyjä kuppeja, huuhtelemalla ne kuumalla vedellä tai pitämällä ne vähintään 20 minuuttia kytketyn kahvinkeitimen kuumennetulla kuppialustalla (H) (katso „Vihje kuumemman kahvin valmistuksesta“ Sivun 193).

### Kahvissa on vähän vaahtokruunua

- Kahvin jauhatus on liian karkealla.
- ☞ Kierrä jauhatuksen säätönuppia yhden askeleen vastapäivään, kun mylly jauhaa kahvipapuja kahvin valmistusta varten (katso „Jauhatusasteen asetus“ Sivun 196).
- Kahvisekoitus ei ole sopiva.
- ☞ Käytä täysautomaattiseen kahvinkeitimeen soveltuvaa kahvisekoitusta.

### Kahvi valuu ulos liian hitaasti

- Kahvin jauhatus on liian hieno.
- ☞ Kierrä jauhatuksen säätönuppia yhden askeleen myötäpäivään, kun mylly jauhaa kahvipapuja kahvin valmistusta varten (katso „Jauhatusasteen asetus“ Sivun 196).

### Kahvi valuu ulos liian nopeasti

- Kahvin jauhatus on liian karkealla.
- ☞ Kierrä jauhatuksen säätönuppia yhden askeleen vastapäivään, kun mylly jauhaa kahvipapuja kahvin valmistusta varten (katso „Jauhatusasteen asetus“ Sivun 196).

### Kahvia tulee vain kahviputken aukoista

- Ulostuloaukot ovat tukossa.
- ☞ Voit puhdistaa poistamalla kuivunut kahvi neulalla (kuva 29).

### Vaikka höyryn ja kuuman veden kiertonuppia kiertää, ei höyrysuuttimesta tule höyryä

- Höyrysuuttimen pienet reiät tai höyrysuuttimen sisäosa on tukossa.
- ☞ Puhdista höyrysuuttimen pienet reiät ja höyrysuuttimen sisäosa.

### Kun toiminto ☞ tai ☞ on valittu, ei keittimestä tule kahvia, vaan vettä

- Kahvijauhe on voinut liimautua täyttöaukkoon.
- ☞ POista täyttöaukkoa tukkiva kahvijauhe veitsen avulla (katso „Kahvin valmistaminen kahvijauheesta“ Sivun 194) (kuva 22). Puhdista sitten vedenkuumennusyksikkö ja keittimen sisäosat (katso „Vedenkuumennusyksikön puhdistus“ Sivun 198)

### Keitin ei käynnisty, kun painat painiketta ①

- Laitteen takasivussa oleva pääkytkin ei ole kytketty (kuva 8) tai verkkopistoke ei ole pistorasiassa.
- ☞ Tarkista, että pääkytkin on asennossa „I“, ja että verkkojohto on liitetty oikein pistorasiaan.



### Vedenkuumennusyksikköä ei saa irti puhdistusta varten

- Kahvinkeitimen virta on kytketty. Vedenkuumennusyksikkö voidaan poistaa vain keittimen ollessa poiskytketynä.
- ☞ Kytke laite pois päältä ja ota vedenkuumennusyksikkö pois (katso „Vedenkuumennusyksikön puhdistus“ Sivun 198).





- ☹ **Huom!:** Vedenkuumennusyksikkö voidaan irrottaa vain, jos laite on sammutettu laitteen etusivussa olevalla virtakytkimellä ①. Laitetta ei tule irrottaa sähköverkosta. Jos koetat

irrottaa vedenkuumennusyksikön kahvinkeitTIMEN ollessa kytkettynä, saattaa se vaurioitua vakavasti.

**Kahvi ei tule kahviputken aukoista, vaan sivusta huoltoluukusta**

- Kuivunut kahvi on tukkinut kahviputken aukot.
-  Poista kuivunut kahvi neulalla (kuva 29).
- Huoltoluukun sisäosassa oleva kääntölokero (R) on tukossa eikä käänny.
-  Puhdista kääntölokero huolellisesti, etenkin saranoiden läheltä, jotta ne pysyvät liikkuvina.

**On käytetty kahvijauhetta (kahvipapujen sijasta), ja kone ei valmista kahvia.**

- On täytetty liikaa esijauhattua kahvia.
-  Poista vedenkuumennusyksikkö ja puhdista kahvinkeitTIMEN sisäosa perusteellisesti kohdan „Vedenkuumennusyksikön puhdistus” Sivu 198” mukaisesti. Toista toimenpide ja käytä korkeintaan 2 tasapäistä mittalusikkaa kahvijauhetta.
- Kiertonuppi "Kahvin voimakkuus / jauhattu kahvi" ei ollut asennossa  tai  ja laite on käyttänyt sekä jauhattua kahvia että myös myllyn jauhaman kahvijauheen.
-  Puhdista keittimen sisäosa perusteellisesti, kohdassa „Vedenkuumennusyksikön puhdistus” Sivu 198 selostetulla tavalla. Toista toimenpide, kierrä ensin kiertonuppi "kahvin voimakkuus / jauhattu kahvi" oikeaan asentoon, kuten kohdassa „Kahvin valmistaminen kahvijauheesta” Sivu 194 selostetaan.
- Jauhattu kahvi täytetään poiskytettynä keittimeen.
-  Poista vedenkuumennusyksikkö ja puhdista kahvinkeitTIMEN sisäosa perusteellisesti kohdan „Vedenkuumennusyksikön puhdistus” Sivu 198” mukaisesti. Toista menettely keittimen ollessa kytkettynä.

**Mitä pitää tehdä, jos laite on kuljetettava toiseen paikkaan?**

- Säilytä laitteen alkuperäinen pakkaus mahdollista kuljetusta varten. Käytä ehdottomasti alkuperäinen muovipussi suojana naarmuja vastaan.
- Suojaa laite ja termoskannu iskuilta. Emme ota mitään vastuuta kuljetuksen aikana sattuneista vahingoista.
- Tyhjennä vesisäiliö ja hylkykahviastia
- Kiinnitä huomiota laitteen varastointipaikkaan erityisesti kylminä vuodenaikoina. Pakkanen voi vioittaa laitetta.



## 17 Tilastotoiminto

Laite tarjoaa mahdollisuuden katsoa seuraavat arvot:



- siihen asti laitteella valmistettujen juomien lukumäärä,
- valmistettujen kahvikannullisten määrä, joissa 4 kupillista, 6 kupillista, 8 kupillista ja 10 kupillista,
- suoritettujen kalkinpoistojen määrä ja lisäksi
- koneen valuttamien vesilitrojen lukumäärä.

 Jos valmistetaan samanaikaisesti kaksi kupillista kahvia, lasketaan määrä 2 kupillisisena.

Laitteen on oltava kytketty pois päältä, jotta tilastotoiminto voidaan kytkeä päälle.







 Katkaise laitteen virta tarvittaessa virtakytkimellä  (kuva 11).

 Paina "P"-painiketta (kuva 4) vähintään 6 sekunnin ajan.

Symbolien "P" ja  valot syttyvät. Sen lisäksi painikkeiden  ja  yläpuolella olevan 3 pienen symbolin valot syttyvät ilmoittamaan painikkeiden sen hetkisen toiminnon, katso „Erikoistoiminto" Sivu 189.

FIN





 Paina selauspainiketta "<" tai ">" (kuva 5) niin monta kertaa, kunnes näyttöön tulee symboli, jonka tilaston haluat näkyviin:

-  Valmistettujen kahvien lukumäärä
-  Suoritettujen kalkinpoistokertojen määrä
-  Valmistettujen kannujen määrä, joissa 4 kupillista
-  Valmistettujen kannujen määrä, joissa 6 kupillista
-  Valmistettujen kannujen määrä, joissa 8 kupillista
-  Valmistettujen kannujen määrä, joissa 10 kupillista
-  Valutettujen vesilitrojen lukumäärä

Kun symbolin valo palaa, saat siihen kuuluvat lukumäärän näyttöön seuraavasti:

 Paina "OK"-painiketta ja pidä sitä painettuna (kuva 5).





Yksittäisten näyttöjen valot alkavat nyt vilkkua vuorotellen. Ne ilmoittavat kysytyn lukumäärän:

-  1 x merkitsee  
1
-  1 x merkitsee  
10
-  1 x merkitsee  
100
-  1 x merkitsee  
1,000
-  1 x merkitsee  
10,000

Vilkkuminen toistuu niin kauan kuin "OK" -painiketta painetaan. Jokaista toistoa edeltää 3 sekunnin tauko.

 Laske yksittäisten vilkkuvalojen lukumäärä.

Esimerkki: Seuraava vilkkumissarja vastaa lukua 1529.

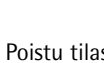
-  Vilkkuu 9 x
-  Vilkkuu 2 x
-  Vilkkuu 5 x
-  Vilkkuu 1 x
-  Vilkkuu 0 x

 Poistu tilastotoiminnosta painamalla "P"-painiketta (kuva 4) vähintään 6 sekunnin .

## 18 Tekniset tiedot

Verkköjännite: 220-240 V  
Ottoteho: 1350 W

 Laite on seuraavien EY-direktiivien mukainen:

- 73/23/ETY, päiv. 19.02.1973 pienjännitedirektiivi sekä muutosdirektiivi 93/68/ETY.
- 89/336/ETY, päiv. 03.05.1989 sähkömagneettista yhteensopivuutta koskeva direktiivi sekä muutosdirektiivi 92/31/ETY.

## 19 Hävittäminen



### Pakkausmateriaali

Pakkausmateriaalit ovat haitattomia ja kierrätettäviä. Muoviosat on merkitty esim. >PE<,> PS< jne. Toimita pakkausmateriaalit lajiteltuina niille varattuihin kunnallisiin keräyspisteisiin.



### Käytöstä poistettu laite

Tuotteessa tai sen pakkauksessa oleva

symboli  ilmoittaa, että tätä tuotetta ei saa käsitellä tavallisena kotitalousjätteenä, vaan se on luovutettava sähkö- ja elektroniikkalaitteiden keräyspisteeseen. Hävittämällä tuotteen oikein vaikutat osaltasi ympäristönsuojeluun ja estät lähimmäisesi terveyteen kohdistuvat haittavaikutukset. Laitteen väärä hävittäminen vaarantaa ympäristön ja terveyden. Lisätietoja tämän tuotteen kierrätyksestä saat paikallisesta kunnanvirastosta, jätehuollosta tai liikkeestä, josta hankit tuotteen.

## 20 Huoltotapauksessa

Säilytä ehdottomasti alkuperäinen pakkaus vaahtomuoviosat mukaanlukien. Kuljetusvaurioiden välttämiseksi tulee laitteen olla hyvin pakattu.

Kun lähetät laitteen huollettavaksi/ korjattavaksi, pakkaa mukaan myös termoskannu. Sitä tarvitaan laitteen testauksessa.

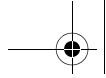

FIN

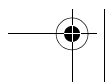
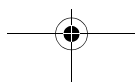
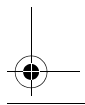
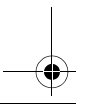
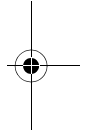
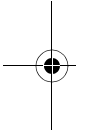

## **CZ** Vážená zákaznice, vážený zákazníku,

laskavě si pečlivě přečtěte tento návod k obsluze. Dodržujte především bezpečnostní pokyny! Návod k použití pečlivě uschovejte a předejte ho i případnému dalšímu majiteli přístroje.

### Obsah

<b>1 Popis obrázků</b>	<b>208</b>	<b>10 Příprava horké vody</b>	<b>218</b>
1.1 Pohled zepředu (obr. 1)	208	<b>11 Nastavení stupně mletí</b>	<b>218</b>
1.2 Pohled zepředu na přístroj s otevřenými servisními dvířky (obr. 2)	208	<b>12 Nastavení teploty kávy</b>	<b>219</b>
1.3 Ovládací panel (obr. 3)	208	<b>13 Čištění a péče</b>	<b>219</b>
<b>2 Káva a espresso</b>	<b>209</b>	13.1 Pravidelné čištění	219
<b>3 Bezpečnostní pokyny</b>	<b>209</b>	13.2 Vyprázdnění nádobky na kávovou sedlinu	220
<b>4 Zvláštní režim</b>	<b>211</b>	13.3 Čištění mlýnku	220
<b>5 První použití</b>	<b>211</b>	13.4 Čištění spařovací jednotky	220
5.1 Umístění přístroje a jeho připojení	211	13.5 Spuštění odvápnovacího programu	221
5.2 Doplnění vody	211	<b>14 Objednávání příslušenství</b>	<b>223</b>
5.3 Nasypání zrnkové kávy do zásobníku	211	<b>15 Co dělat, když se na displeji objeví následující hlášení...</b>	<b>223</b>
5.4 První zapnutí	212	<b>16 Obtíže, které se můžete pokusit odstranit, než se obrátíte na servis</b>	<b>224</b>
5.5 Zapnutí přístroje	212	<b>17 Režim Statistika</b>	<b>226</b>
5.6 Vypnutí přístroje	212	<b>18 Technické údaje</b>	<b>226</b>
5.7 Nastavení tvrdosti vody	213	<b>19 Likvidace</b>	<b>227</b>
<b>6 Příprava nápoje ze zrnkové kávy</b>	<b>213</b>	<b>20 Servis</b>	<b>227</b>
6.1 Tipy pro přípravu teplejší kávy	215		
<b>7 Příprava více šálků kávy funkcí Konvice</b>	<b>215</b>		
<b>8 Příprava nápoje z mleté kávy</b>	<b>216</b>		
<b>9 Napěnění mléka</b>	<b>217</b>		
9.1 Vyčištění parní trysky	218		

CZ

## 1 Popis obrázků















### 1.1 Pohled zepředu (obr. 1)

- A** Odkapávací mřížka
- B** Termokonvice
- C** Hlavní vypínač  
(na zadní straně přístroje)
- D** Výškově přestavitelný výtok
- E** Ovládací panel (viz obr. 3)
- F** Víko zásobníku na zrnkovou kávu
- G** Víko násypky na mletou kávu
- H** Ohřívané místo pro šálky
- J** Otočná trubka pro páru  
a horkou vodu
- K** Parní tryska (demontovatelná)
- L** Vnitřní část parní trysky  
(demontovatelná)
- M** Uvolňovací tlačítko servisních dvířek
- N** Zásobník na vodu se značkou  
maxima (vyjímatelný)
- O** Odkapávací nádoba s plovákem  
(vyjímatelná)

### 1.2 Pohled zepředu na přístroj s otevřenými servisními dvířky (obr. 2)

- P** Servisní dvířka (otevřená)
- Q** Nádobka na kávovou sedlinu  
(vyjímatelná)
- R** Výklopná přihrádka
- S** Spařovací jednotka
- T** Točítka pro nastavení stupně mletí
- U** Zásobník na zrnkovou kávu
- V** Odměrka
- W** Plnicí násypka pro mletou kávu
- X** Typový štítek (spodní strana přístroje)
- Y** Tekutý odvápnovač
- Z** Zkušební proužek

### 1.3 Ovládací panel (obr. 3)

- a** Otočný spínač „Síla kávy / mletá káva“
- b** Otočný spínač „Velikost šálku“
- c** Displej
- d** Tlačítko „1 šálek kávy“   
Ve zvláštním režimu je toto tlačítko určeno pro „Listování“ („<“)
- e** Tlačítko „2 šálky kávy“   
Ve zvláštním režimu je toto tlačítko určeno pro „Listování“ („>“)
- f** Tlačítko „Pára“   
Ve zvláštním režimu potvrdíte tímto tlačítkem bod menu („OK“)
- g** Tlačítko „P“  
Ve zvláštním režimu se tímto tlačítkem vrátíte na poslední úroveň bez přijetí změny („P“)
- h** Tlačítko „Zapnout/vypnout“ 
- j** Otočný spínač pro páru  
a horkou vodu
- k** Tlačítko „Konvice“ 
- l** Symboly „Mletá káva“
- m** Symboly „Konvice“
- n** Symboly „Síla kávy“
- o** Symboly „Velikost šálku“
- p** Symbol „Zásobník na vodu je prázdný“ 
- q** Symbol „Odvápnění“ 
- r** Symbol „Teplota přístroje“ 
- s** Symbol „Servisní dvířka otevřená“ 
- t** Symbol „Nádobka na kávovou sedlinu“ 
- u** Symbol „Pozor“ 
- v** Symbol „Horká voda“ 
- w** Symbol „Pára“ 
- x** Symbol „Příprava 2 šálků“ 
- y** Symbol „Příprava 1 šálku“ 
- z** Symboly zvláštního režimu



## 2 Káva a espresso

Vybavení plně automatického kávovaru umožňuje nejen velmi snadno **připravit** kávu, ale i provádět údržbu přístroje.

Následující funkce jsou určeny pro individuální **nastavení** přístroje:

- systém předběžného spaření: mletá káva je ještě před vlastním spařením navlhčena, aby uvolnila plné aroma,
- individuální nastavení množství vody na šálek v rozsahu od silného espressa až po slabší kávu s pěnou,
- individuální nastavení teploty pro spaření kávy,
- možnost volby normální nebo silné kávy,
- nastavení stupně mletí podle upražení kávy,
- a v neposlední řadě také příprava pěny, tedy oné napěněné koruny, která nedomyslitelně patří k espressu. Poznámka: Mletá káva je při přípravě espressa spařena za mnohem kratší dobu, než při přípravě běžné filtrované kávy. Tím se z kávy uvolňuje podstatně méně hořčin, a tedy espresso je zdravější.

## 3 Bezpečnostní pokyny



Bezpečnost tohoto přístroje splňuje uznávané technické zásady a zákon o bezpečnosti zařízení. Přesto jako výrobce cítíme povinnost vás seznámit s následujícími bezpečnostními pokyny.

### Základní zásady bezpečnosti

- Přístroj smí být připojen pouze k elektrické síti s napětím, druhem proudu a frekvencí, které odpovídají údajům na typovém štítku (na spodní straně přístroje)!
- Přívodní kabel nesmí přijít do styku s horkými díly přístroje.
- Za žádných okolností nevytahujte vidlici síťové šňůry ze síťové zásuvky tahem za kabel.
- Přístroj nezapínejte, jestliže:
  - je přívodní kabel poškozený, nebo
  - kryt přístroje je viditelně poškozený.
- Vidlici zapojte do síťové zásuvky pouze v případě, že je přístroj vypnutý.
- Tento přístroj nesmějí používat osoby (včetně dětí), které vzhledem ke své nezkušenosti nebo neznalosti nejsou schopné ho bezpečně obsluhovat, ani osoby (včetně dětí) s omezenými fyzickými, sensorickými nebo duševními schopnostmi, pokud nebyly poučeny odpovědnou osobou, jak přístroj bezpečně obsluhovat, a nenaučily se přístroj ovládat pod jejich dohledem.

### Zajištění bezpečnosti dětí

- **Nenechávejte zapnutý přístroj bez dozoru, a to především v případě, když se jeho v blízkosti nacházejí děti!**
- Obalový materiál, jako např. plastový sáček, nepatří do rukou dětí.

CZ

### Bezpečnost za provozu

- **Pozor! Výtok kávy, parní tryska a mřížka pro odkládání šálků jsou u zapnutého přístroje z provozních důvodů horké. Nedovolte, aby se jich děti dotýkaly!**
- **Pozor! Nebezpečí popálení parní tryskou! Vytékající horká voda resp. horká pára mohou způsobit popáleniny. Otevřete parní trysku pouze v případě, že se pod ní nachází nádoba.**
- Párou neohřívejte hořlavé kapaliny!
- Přístroj zapněte jen v případě, že je naplněn vodou! Do zásobníku na vodu nalévejte pouze studenou vodu **a v žádném případě horkou vodu, mléko ani jiné tekutiny.** Upozorňujeme, že maximální obsah přístroje je 1,8 litru.
- **Do zásobníku na zrnkovou kávu sypejte pouze praženou zrnkovou kávu, v žádném případě mražená nebo karamelizovaná kávová zrna! Odstraňte z kávy nežádoucí příměsi, jako např. drobné kaménky. Na zablokování nebo poškození mlýnku nežádoucími příměsmi se nevztahuje záruka.**
- Do otvoru na mletou kávu sypejte výhradně mletou kávu.
- Přístroj nesmí být zapnutý, pokud není používán.
- Přístroj chraňte proti povětrnostním vlivům.
- Jestliže je nutno přístroj připojit prodlužovacím kabelem, použijte běžný kabel s průřezem min. 1,5 mm<sup>2</sup>.
- Osoby s motorickými poruchami by měly obsluhovat přístroj pouze v přítomnosti dohlížející osoby.
- **Přístroj musí být používán výhradně s odkapávací miskou, nádobkou na kávovou sedlinu a odkapávací mřížkou!**

### Bezpečnost při čištění a péči

- Řiďte se pokyny pro čištění a odvápnění.
- Před údržbou a čištěním je nutno přístroj vypnout a vytáhnout vidlici síťové šňůry ze zásuvky!
- Přístroj nesmí být ponořen do vody.
- Při čištění parní trysky musí být přístroj vypnutý, studený a nesmí být pod tlakem!
- Díly přístroje nesmějí být umývány v myčce.
- **Do mlýnku nelijte vodu, protože by mohlo dojít k jeho poškození.**

Přístroj neotvírejte a neopravujte. Neodborné opravy mohou ohrozit zdraví uživatele.



Opravy elektrických přístrojů smějí provádět pouze kvalifikovaní pracovníci.



Jestliže přístroj vyžaduje opravu nebo výměnu síťové šňůry, obraťte se laskavě na

- prodejce, u něhož jste přístroj zakoupili
- servisní linku společnosti AEG/ Electrolux.

**Záruka se nevztahuje na škody, které jsou způsobeny používáním přístroje způsobem, k němuž není určen, anebo nesprávnou obsluhou. To platí i v případě, že není okamžitě proveden odvápnovací program podle pokynů uvedených v tomto návodu k obsluze, jakmile se objeví na displeji . Na zablokování nebo poškození mlýnku nežádoucími příměsmi se nevztahuje záruka.**

## 4 Zvláštní režim

Při nastavení tvrdosti vody („Nastavení tvrdosti vody“, str. 213) a teploty kávy („Nastavení teploty kávy“, str. 219), spuštění odvápnovacího programu („Spuštění odvápnovacího programu“, str. 221) a vyvolání statistiky („Režim Statistika“, str. 226) stisknutím tlačítka „P“ (obr. 4) aktivujete zvláštní režim. Ve zvláštním režimu jsou tlačítka „1 šálek kávy“ , „2 šálky kávy“ , „Pára“  a „P“ určena k navigaci. Příslušná funkce je zobrazena na displeji nad tlačítkem (obr. 5):

- „<“ („1 šálek kávy“ ) a „>“ („2 šálky kávy“ ) umožňují pohyb v menu.
- „OK“ („Pára“ ) potvrdí zvolený bod
- „P“ („P“) provede návrat na předcházející úroveň bez uložení změny

## 5 První použití

### 5.1 Umístění přístroje a jeho připojení

Přístroj umístěte na vhodný rovný, stabilní, nevyhříváný, suchý a vodě odolný podklad.

-  Zajistěte dostatečný oběh vzduchu. Na stranách a na zadní straně přístroje musí být volný prostor min. 5 cm a nad přístrojem alespoň 20 cm.

Přístroj nesmí být umístěn do místnosti, v níž může teplota klesnout pod 0 °C (zmrzlá voda poškodí přístroj).



-  **Pozor!** Jestliže přístroj přenesete z chladného prostředí do teplé místnosti, vyčkejte cca. 2 hodiny, než ho zapnete!

Doporučujeme přístroj umístit na podložku, aby nedošlo k poškození podkladu odstříkující vodou.

-  Přístroj je nutno připojit výhradně do uzemněné zásuvky. Přístroj nepřipojujte k zásuvce, která není uzemněná.

### 5.2 Doplnění vody

Před každým zapnutím přístroje se přesvědčte, zda je v zásobníku voda a podle potřeby ji doplňte. Přístroj spotřebovává vodu při každém zapnutí resp. vypnutí na automatické proplachování.

-  Vyjměte z přístroje zásobník na vodu (obr. 6). Otočte parní trysku ke středu přístroje, protože jinak nelze zásobník na vodu z přístroje vyjmout.
-  Nalijte do zásobníku čerstvou studenou vodu. Hladina vody nesmí sahat nad značku MAX.

-  Do zásobníku na vodu doplňujte pouze studenou vodu. Nenalévejte do něj jiné kapaliny, jako např. minerální vodu nebo mléko.

-  Zasuňte zásobník s vodou do přístroje (obr. 6). Přitom ho pevně přitiskněte do provozní polohy, aby se otevřel ventil zásobníku.

-  Jestliže má být zajištěna automatická příprava kávy, je nutno:

- každý den měnit vodu v zásobníku
- zásobník na vodu je třeba alespoň jednou týdně vypláchnout vodou (nikoli v myčce). Nakonec zásobník vypláchněte čerstvou vodou.

### 5.3 Nasypání zrnkové kávy do zásobníku

-  Odklopte víko zásobníku na zrnkovou kávu a nasypte do něj čerstvá kávová zrna (obr. 7). Opět zavřete víko.

-  **Pozor!** Do zásobníku na zrnkovou kávu sypejte pouze praženou zrnkovou kávu, v žádném případě mražená nebo karamelizovaná kávová zrna! Zkontrolujte, zda mezi zrny v zásobníku nejsou nežádoucí příměsi, jako např. kaménky. **Na zablokování nebo poškození mlýnku nežádoucími příměsí se nevztahuje záruka.**

CZ

**i** Mlýnek je ve výrobě nastaven na střední stupeň mletí. Podle potřeby lze toto nastavení změnit. Postup při změně stupně mletí je uveden v části „Nastavení stupně mletí“, str. 218.

**!** **Stupeň mletí smí být měněn pouze v průběhu mletí. Změna nastavení na vypnutém mlýnku může způsobit poškození kávovaru.**

**i** Kávovar prošel výrobní kontrolou. Při této kontrole byla použita káva, a tedy je zcela normální, že zůstala v mlýnku. Tento kávovar je však zaručeně nový.

#### 5.4 První zapnutí

Před prvním uvedením do provozu je třeba kávovar odzdušnit.

**☞** Zapněte přístroj hlavním vypínačem na zadní straně (obr. 8).

Při prvním zapnutí hlavního vypínače se v průběhu vlastního testu rozsvítí všechny symboly na displeji na několik sekund a poté začnou blikat symboly ☼ a △.

**☞** Naplňte zásobník na vodu – viz „Doplnění vody“, str. 211.

**☞** Zasuňte zásobník s vodou do přístroje (obr. 6). Přitom ho pevně přitiskněte do provozní polohy, aby se otevřel ventil zásobníku.

**☞** Otočte parní trysku směrem ven a postavte pod ní šálek (obr. 9).

**☞** Otočný spínač pro páru a horkou vodu nastavte proti směru pohybu hodinových ruček do krajní polohy ☼☼ (obr. 10).

Z parní trysky unikne malé množství vody. Symboly ☼☼ a △ svítí nepřerušovaně.

Jakmile je šálek naplněn 30 ml vody, začnou symboly ☼☼ a △ an zu blikat.

**☞** Otočný spínač pro páru a horkou vodu nastavte ve směru pohybu hodinových ruček do krajní polohy ● (obr. 10), čímž uzavřete výtok vody.

Symbol ☼ bliká několik sekund a přístroj se vypne.

**☞** Doplňte zrnkovou kávu do příslušného zásobníku – viz „Nasypání zrnkové kávy do zásobníku“, str. 211.

#### 5.5 Zapnutí přístroje

Před každým zapnutím přístroje se přesvědčte, zda je v zásobníku voda a podle potřeby ji doplňte. Přístroj spotřebovává vodu při každém zapnutí resp. vypnutí na automatické proplachování.

**☞** Zapněte přístroj tlačítkem „Zapnout/vypnout“ Ⓛ (obr. 11).

**i** Bezprostředně po zapnutí je provedeno nastavení přístroje. Zvuk, který se přitom ozývá, je zcela normální.

**i** Po celou dobu ohřevu (cca. 120 s) bliká symbol ☼.

V průběhu ohřevu provede přístroj automatické propláchnutí (z výtoku kávovaru vyteče malé množství horké vody, která bude zachycena do odkapávací misky).

Po ukončení ohřevu začne svítit symbol ☼ nepřerušovaně.

Přístroj je nyní připraven k provozu. Symboly se rozsvítí v závislosti na posledním zvoleném režimu.

#### 5.6 Vypnutí přístroje

**☞** Vypněte přístroj tlačítkem „Zapnout/vypnout“ Ⓛ (obr. 11).

Symbol ☼ bliká. Přístroj provede proplachovací cyklus a vypne se.

**i** Jestliže přístroj není používán delší dobu, automaticky se vypne z úsporných důvodů po třech hodinách.

**i** Pokud přístroj nebudete používat delší dobu, měli byste ho vypnout tlačítkem „Zapnout/vypnout“ a hlavním vypínačem za zadní straně přístroje (obr. 8).

## 5.7 Nastavení tvrdosti vody

Po prvním uvedení přístroje do provozu nebo při používání vody jiné kvality je třeba nastavit přístroj na stupeň tvrdosti vody, který odpovídá tvrdosti místní vody. Stupeň tvrdosti vody stanovte přiloženým zkušebním proužkem anebo se informujte ve vodárně.

### Zjištění stupně tvrdosti vody

- Ponořte zkušební proužek na cca. 1 s do studené vody. Nechejte okapat vodu a určete stupeň tvrdosti podle růžově zbarvených polí.

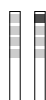

**Žádné** nebo **jedno** růžové pole:  
**Stupeň tvrdosti 1, měkká**  
 až 1,24 mmol/l resp.  
 až 7° německé stupnice resp.  
 až 12,6° francouzské stupnice

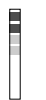

**Dvě** růžová pole:  
**Stupeň tvrdosti 2, středně tvrdá**  
 až 2,5 mmol/l resp.  
 až 14° německé stupnice resp.  
 až 25,2° francouzské stupnice

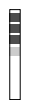

**Tři** růžová pole:  
**Stupeň tvrdosti 3, tvrdá**  
 až 3,7 mmol/l resp.  
 až 21° německé stupnice resp.  
 až 37,8° francouzské stupnice



**Čtyři** růžová pole:  
**Stupeň tvrdosti 4, velmi tvrdá**  
 větší než 3,7 mmol/l resp.  
 větší než 21° německé  
 stupnice resp.  
 větší než 37,8° francouzské  
 stupnice

### Nastavení zjištěného stupně tvrdosti vody a jeho uložení do paměti

Můžete určit čtyři stupně tvrdosti. Výrobce nastavil na přístroji čtvrtý stupeň tvrdosti.

- Po zapnutí přístroje stiskněte tlačítko „P“ (obr. 4).

Symbole „P“ a ☰ se rozsvítí. Dále se nad tlačítka ☰, ☱ a ☲ rozsvítí tři malé symboly, které označují

aktuální funkci těchto tlačítek – viz „Zvláštní režim“, str. 211.

- Potvrďte volbu tlačítkem „OK“ (obr. 5).

Displej zobrazí aktuální nastavení. Stupně tvrdosti jsou zobrazovány následujícím způsobem:

- Stupeň tvrdosti 1
- Stupeň tvrdosti 2
- Stupeň tvrdosti 3
- Stupeň tvrdosti 4

- Poté stiskněte tlačítka pro pohyb v menu „<“ nebo „>“ (obr. 5), dokud se neobjeví zjištěný stupeň tvrdosti.
- Potvrďte volbu tlačítkem „OK“ (obr. 5). Nyní je tento stupeň tvrdosti uložen do paměti.

- i** Pokud nechcete hodnotu uložit, stiskněte „P“ místo „OK“. Pokud není stisknuto „OK“, přístroj se vrátí po cca. 120 sekundách automaticky do režimu přípravy kávy bez uložení údajů.

- Do režimu přípravy kávy se vrátíte tlačítkem „P“ (obr. 4), nebo počkejte cca. 120 sekund, až se přístroj vrátí automaticky do režimu přípravy kávy.

## 6 Příprava nápoje ze zrnkové kávy

Následující postup při přípravě nápoje ze zrnkové kávy probíhá plně automaticky: Mletí, dávkování, stlačení kávy, předběžné spaření, spaření a vyklopení vylouhované kávové sedliny.

Volba stupně mletí a množství namleté kávy umožňuje přizpůsobit přístroj individuálním potřebám.

- !** Do zásobníku na zrnkovou kávu sypejte pouze praženou zrnkovou kávu, v žádném případě mražená nebo karamelizovaná kávová zrna! Zkontrolujte, zda mezi zrny v zásobníku nejsou nežádoucí příměsi, jako např. kaménky. **Na**

CZ

### **zablokování nebo poškození mlýnku nežádoucími příměsmi se nevztahuje záruka.**

Podle chuti nastavte silné espresso nebo slabší kávu s pěnou.

-  Otočným spínačem „Velikost šálku“ (obr. 12) zvolte požadovanou velikost šálku. Na displeji se objeví nastavená velikost šálku.





-  Velikosti šálků jsou zobrazovány následujícím způsobem:

	Šálek espresa
	Malý šálek
	Střední šálek
	Velký šálek
	Pohárek



Je možné zvolit kávu s extra jemnou, jemnou, normální, silnou a extra silnou chutí.



-  Otočným spínačem „Síla kávy“ (obr. 13) zvolte požadovanou sílu. Na displeji se objeví nastavená síla kávy.



-  Síla kávy je zobrazována následujícím způsobem:



	extra jemná
	jemná
	normální
	silná
	extra silná



-  Pod výtok kávy postavte jeden nebo dva šálky (obr. 14). Posunutím výtok kávy nahoru nebo dolů lze optimálně přizpůsobit polohu výtoku výšce šálků, a tím zabránit ochlazení kávy i jejímu rozstříkávání (obr. 15).



-  Stiskněte tlačítko „1 šálek kávy“  při přípravě jednoho šálku nebo tlačítko „2 šálky“  při přípravě 2 šálků.

Rozsvítí se symbol „1 šálek“  nebo „2 šálky“ . Přístroj mele pouze kávová zrna. Při přípravě kávy je mletá káva nejprve při předběžném spaření zvlhčena malým množstvím vody. Po krátkém přerušení začíná vlastní spařování. Při nalévání kávy do šálků.



Jakmile je nalito požadované množství kávy, přístroj automaticky ukončí nalévání a vysype kávovou sedlinu do nádobky na sedlinu. V průběhu této doby bliká symbol „1 šálek“  resp. „2 šálky“ .



-  Nalévání kávy můžete kdykoli ukončit opětovným krátkým stisknutím tlačítka „1 šálek“  či „2 šálky“  nebo otočte otočný spínač „Velikost šálku“ (obr. 12) proti směru pohybu hodinových ruček do polohy „Šálek espresa“.

-  Jakmile je káva nalita, můžete její množství zvýšit stisknutím tlačítka „1 šálek“  nebo „2 šálky“ , přičemž tlačítko přidržte ve stisknuté poloze, dokud není dosaženo požadovaného množství, nebo otáčejte otočným spínačem „Velikost šálku“ (obr. 12) ve směru pohybu hodinových ruček do polohy „Pohárek“ (volbu je nutno provést bezprostředně po nalití kávy a před vysypáním sedliny do nádobky na kávovou sedlinu).

Jakmile po několika sekundách zhasne symbol „1 šálek“  nebo „2 šálky“ , přístroj je znovu připraven k provozu a můžete připravit další šálek.

-  Jestliže káva vytéká pouze po kapkách nebo nevytéká vůbec, popř. vytéká velmi rychle a pěna nesplňuje vaše představy, měli byste změnit nastavený stupeň mletí – viz „Nastavení stupně mletí“, str. 218.

-  Jestliže blikají symboly  a , káva je namleta příliš jemně. Je třeba změnit stupeň mletí – viz „Nastavení stupně mletí“, str. 218.

-  V případě, že se rozsvítí symbol , je nutno dolít vodu do zásobníku na vodu, protože v opačném případě nelze nápoj připravit. (Je zcela normální, že se rozsvítí symbol i v případě, že v zásobníku ještě zůstal zbytek vody.)

**i** Jestliže se rozsvítí symbol , nádoba na kávovou sedlinu je plná a je třeba ji vyprázdnit a vyčistit – viz „Vyprázdnění nádoby na kávovou sedlinu“, str. 220. Dokud není nádoba na kávovou sedlinu vyčištěna, svítí symbol a přístroj nemůže připravit nápoj.

**i** V průběhu nalévání kávy nevyjímejte zásobník na vodu. Vyjmete-li zásobník, přístroj nemůže pokračovat v přípravě kávy. Při odvodušňování kávovaru nastavte otočný spínač pro páru a horkou vodu do krajní polohy ve směru pohybu hodinových ruček  a nechte několik sekund vytékat vodu z parní trysky.

**i** Při prvním zapnutí kávovaru byste měli připravit alespoň 4-5 šáleků, než budete moci připravit skutečně chutný nápoj.

### 6.1 Tipy pro přípravu teplejší kávy

- Pokud ihned po zapnutí přístroje chcete namlít malé množství kávy pro přípravu malého šálku (menší množství než 60 ml), předeďte šálek proplachovací horkou vodou.
- Zvolte v odpovídajícím menu vyšší teplotu kávy – viz „Nastavení teploty kávy“, str. 219.
- Nepoužívejte silnostěnné šálky, které velmi rychle odvádějí teplo, nebo je nejprve předeďte.
- Používejte předeřáté šálky, které ohřejete teplou vodou anebo je postavte na alespoň 20 minut na ohřívanou mřížku pro odkládání šáleků (H), přičemž přístroj musí být zapnutý.

## 7 Příprava více šáleků kávy funkcí Konvice

Tato funkce umožňuje připravit plně automaticky **několik šáleků kávy přímo do termokonvice z nerezové ocele, která je součástí kávovaru**: Mletí, dávkování, stlačení kávy, předběžné spaření, spaření a vyklopení

vylouhované kávové sedliny probíhá jako ve výše uvedeném odstavci.

**☞** Otočte víko nerezové termokonvice do polohy pro otevření (obr. 16) a víko sejměte. Vypláchněte konvici a víko.

**☞** Nasad'te víko na termokonvici do polohy pro nalévání (obr. 17) a postavte konvici pod výtok kávy (D). Výtok kávy se musí nacházet v nejvyšší poloze, aby bylo možné umístit termokonvici pod výtok.

Jeden ze symbolů funkce konvice se rozsvítí v závislosti na počtu šáleků zvolených při posledním použití funkce konvice. Dále svítí symboly listování „<“ a „>“.

Počet šáleků, který má být připraven do konvice, je zobrazován následujícím způsobem:

 4 šálky

 6 šáleků

 8 šáleků

 10 šáleků

**☞** Přesvědčte se, zda je zásobník na vodu plný, zda je v zásobníku na zrnkovou kávu dostatečné množství kávy a zda nádoba na kávovou sedlinu je prázdná, aby mohla být káva připravena.

**i** Jestliže chcete změnit sílu kávy a plnicí množství pro funkci konvice, použijte otočný spínač „Velikost šálku“ (obr. 12) resp. otočný spínač „Síla kávy“ (obr. 13) podle odstavce „Příprava nápoje ze zrnkové kávy“, str. 213.

**☞** Zvolte podle potřeby tlačítka pro listování „<“ nebo „>“ symbol odpovídající počtu šáleků, který má být připraven do konvice, např.  pro 8 šáleků.

**☞** Stiskněte tlačítko „Konvice“  (obr. 18).

V průběhu přípravy kávy bliká symbol konvice se zvoleným počtem šáleků.



CZ

Jakmile je spařování ukončeno, blikají střídavě všechny symboly konvice, přičemž symbol zvoleného počtu šálků svítí dvojnásobně dlouhou dobu než ostatní symboly.

-  Vyměňte termokonvici a přiklopte ji víkem (obr. 19), aby káva zůstala teplá delší dobu.

Přístroj se automaticky vrátí do režimu přípravy kávy.







-  Jestliže množství zrnkové kávy nebo vody v zásobníku na vodu nedostačuje pro dokončení zvolené funkce anebo je nádobka na kávovou sedlinu plná, přístroj přeruší prováděnou funkci a program. Po odstranění chyby je nutno program znovu spustit. Nezapomeňte, že v konvici může být již nalitá káva, a při dalším provozu kávovaru může dojít k přeplnění konvice.

-  Jestliže blikají symboly  a , káva je namleta příliš jemně. V takovém případě je třeba změnit stupeň mletí – viz „Nastavení stupně mletí“, str. 218.



## 8 Příprava nápoje z mleté kávy

Tato funkce umožňuje spařit namletou, např. bezkofeinovou kávu.

-  Pozor! Přesvědčte se, zda v násypce nezůstala mletá káva ani nežádoucí příměsi. Plnicí násypka není zásobník. Mletá káva se musí dostat přímo do spařovací jednotky.

-  Nastavením otočného spínače „Síla kávy / mletá káva“ (obr. 20) do požadované polohy  (pro 1 šálek) nebo  (pro 2 šálky) zvolte funkci pro mletou kávu. Rozsvítí se symbol  (pro 1 šálek) nebo oba symboly   (pro 2 šálky).

-  Otevřete kryt násypky pro mletou kávu a nasypete do přístroje čerstvě namletou kávu (obr. 21).

Používejte pouze odměrku, která je součástí kávovaru. Nesypejte do kávovaru více než dvě zarovnané odměrky, protože v opačném případě přístroj nezačne připravovat kávu a namletá káva zůstane v přístroji a znečistí ho, nebo káva bude nalévána po kapkách a začnou blikat symboly  a .



V průběhu spařování nedoplňujte mletou kávu. Jakmile je spařování dokončeno a přístroj je opět připraven k použití, je možné doplnit mletou kávu pro další šálek. Nesypejte mletou kávu do vypnutého přístroje, protože by zanesla vnitřek přístroje.

-  Mletou kávu používejte pouze v plně automatických kávovarech pro přípravu espresa. Do násypky nesypete zrnkovou kávu, vodou rozpustné prášky, instantní produkty sušené vymrazováním a jiné práškové nápoje. Příliš jemně mletá káva může ucpat násypku.





-  Jestliže je násypka ucpaná (protože je vnitřek přístroje vlhký nebo jste doplnili více než dvě odměrky mleté kávy), nožem anebo obrácenou lžící stlačte mletou kávu dolů (obr. 22). Vyměňte spařovací jednotku. Očistěte jednotku i kávovar podle pokynů v části „Čištění spařovací jednotky“, str. 220.

-  Zavřete víko.



-  Zvolte požadovanou velikost šálku otočným spínačem „Velikost šálku“ (obr. 12) podle odstavce „Tipy pro přípravu teplejší kávy“, str. 215.

-  Stiskněte tlačítko „1 šálek kávy“  při přípravě jednoho šálku nebo tlačítko „2 šálky“  při přípravě 2 šálků.

Příprava kávy je zahájena.

-  Pokud zvolíte funkci přípravy jednoho šálku z namleté kávy, avšak násypka na mletou kávu je prázdná, po stisknutí tlačítka  začnou blikat symboly  a . Jestliže zvolíte funkci pro přípravu dvou šálků z















namleté kávy, avšak násypka na mletou kávu je prázdná, po stisknutí tlačítka  začnou blikat symboly  a .

-  Pokud se chcete po přípravě kávy vrátit opět do režimu pro přípravu nápoje ze zrnkové kávy, nastavte otočný spínač „Síla kávy / mletá káva“ (obr. 20) na libovolnou sílu kávy (tím je znovu uvolněn mlýnek na kávu).

## 9 Napěnění mléka

Páru lze využít pro napěnění mléka nebo ohřev kapalin. Vzhledem k tomu, že k výrobě páry je zapotřebí vyšší teplota než k přípravě kávy, musí přístroj pracovat v parním režimu.



-  Při přípravě jednoho kapučína naplňte šálek z jedné poloviny až ze dvou třetin espresem a přidejte napěněné mléko.
-  **Pozor!** Nebezpečí popálení parní tryskou! Vytékající horká voda resp. horká pára mohou způsobit popáleniny. Parní trysku otevřete, až když je ponořena do mléka.
-  Při přípravě páry stiskněte tlačítko „Pára“  (obr. 23). Symbol  se rozsvítí a přístroj se začne zahřívat. V průběhu ohřevu se rozsvítí symbol . Po ukončení ohřevu začne symbol  svítit nepřerušovaně. Přístroj je připraven k napěnění mléka.
-  Není-li pára využívána déle než 2 minuty, přístroj se automaticky přepne zpět do režimu přípravy kávy.
-  Aby se při napěňování nepromíchalo mléko se zbytkem vody, vodu nejprve nechejte vytéct. Postavte pod parní trysku vhodnou nádobku, nastavte otočný spínač pro páru a horkou vodu (obr. 10) do polohy  a počkejte, dokud pára nepřestane vycházet z trysky. Poté vraťte otočný přepínač zpět do polohy .

-  Nalijte netučné studené mléko do pohárku, který se musí vejít pod parní trysku přístroje.

-  Mléko by mělo být dostatečně vychlazené. Kromě toho by měla být nádoba – nejlépe kelímek z nerezové oceli – také vychlazená a před použitím ji nevyplachujte teplou vodou.



-  Otočte parní trysku směrem ven a přidržte pohárek pod tryskou tak, aby ústí trysky bylo ponořené těsně pod hladinou mléka (obr. 24).

-  **Pozor!** Hrozí nebezpečí znečištění parní trysky zasklým mlékem. Dbejte, aby parní tryska nebyla ponořena do mléka tak hluboko, aby byl otvor pro nasávání vzduchu na horním konci parní trysky zaplaven mlékem. Tímto otvorem může proniknout mléko do parní trysky a způsobit její znečištění.

-  Nastavte otočný spínač pro páru a horkou vodu (obr. 10) do polohy  . Mléko je napěněno.

-  Pokud chcete dosáhnout krémové mléčné pěny, pohybujte nádobkou pomalu nahoru a dolů. Napěňte mléko nejméně na dvojnásobný objem.

-  Doporučujeme používat páru nejvýše dvě minuty bez přerušení.

-  Jakmile je mléko napěněno, nastavte otočný spínač pro páru a horkou vodu (obr. 10) do polohy  a poté nádobu vyjměte.

-  **Pozor!** Nebezpečí popálení odstříkujícím horkým mlékem! Přívod páry uzavřete dříve, než vyjměte nádobu s napěněným mlékem.

-  Režim výroby páry ukončíte stiskem tlačítka „Pára“ (obr. 23), nebo počkejte cca. 120 sekund, dokud se přístroj nevrátí automaticky do režimu přípravy kávy.

Přístroj je nyní opět připraven k přípravě kávy.

-  Po napěnění mléka nechejte krátce protéct tryskou horkou vodu, přičemž

CZ

nastavte otočný spínač pro páru a horkou vodu (obr. 10) do polohy .







Trysku je třeba propláchnout, protože zaschlé mléko by ji mohlo ucpat.

K čištění používejte vhodnou nádobu. V průběhu tohoto cyklu svítí symbol .

-  Poté nastavte otočný spínač pro páru a horkou vodu opět do polohy ● a na displeji se zobrazí nastavení, které jste zvolili jako poslední.

### 9.1 Vyčištění parní trysky

**Důležité upozornění:** Z hygienických důvodů doporučujeme provádět popisovaný postup po každém napěnění mléka. Tím zabráníte usazování mléka uvnitř parní trysky.

-  Nastavte otočný spínač pro páru a horkou vodu ve směru pohybu hodinových ruček do krajní polohy ●. Vyčkejte několik minut, dokud parní tryska nevychladne.
-  Uchopte otočnou trubku za černé držadlo a povolte bajonetový závit parní trysky mírným pootočením ve směru pohybu hodinových ruček. Stáhněte parní trysku dolů (obr. 25).
-  Vytáhněte vnitřní část parní trysky z otočné trubky směrem dolů.
-  Opláchněte parní trysku a vnitřní část teplou vodou.
-  Zkontrolujte, zda oba otvory na obr. 26 nejsou ucpané. Podle potřeby je propíchněte jehlou a vyčistěte.
-  Znovu upevněte vnitřní část, přičemž ji opatrně nasuňte na otočnou trubku.
-  Namontujte parní trysku – nasadte ji a otočte proti směru pohybu hodinových ruček.

### 10 Příprava horké vody

Horkou vodu lze využít pro ohřev šálků a přípravu horkých nápojů, jako např. čaje nebo instantních polévek.





Pozor! Nebezpečí popálení horkovodní tryskou! Vytékající horká voda může způsobit popáleniny. Otevřete přívod horké vody, až když postavíte pod trysku nádobu.



Postavte vhodnou nádobku pod horkovodní trysku.



Nastavte otočný spínač pro páru a horkou vodu do polohy  (obr. 10). Vytéká horká voda; symbol  svítí.



Doporučujeme odebírat horkou vodu nejvýše dvě minuty bez přerušení.



Po odběru horké vody nastavte otočný spínač pro páru a horkou vodu zpět do polohy ● (obr. 10) a nádobu vyjměte.

### 11 Nastavení stupně mletí



Mlýnek je ve výrobě nastaven na střední stupeň mletí. Pokud je káva nalévána příliš rychle nebo příliš pomalu (po kapkách), můžete v průběhu mletí změnit nastavení stupně mletí.



**Stupeň mletí smí být změněn pouze v průběhu mletí, tzn. ovladačem pro nastavení stupně mletí (obr. 2, T a obr. 27) lze otáčet, dokud je v průběhu přípravy kávy mlýnek v chodu. Změna nastavení na vypnutém mlýnku může způsobit poškození kávovaru.**



Nastavte stupeň mletí otočným spínačem pro volbu stupně mletí (obr. 2, T) (obr. 27).

- Pokud káva vytéká po kapkách nebo nevytéká vůbec (pravděpodobně blikají symboly  a ), je třeba ovladač otočit o jeden dílek ve směru pohybu hodinových ruček. Spínač postupně otáčejte vždy o jeden dílek, dokud káva nezačne vytékat uspokojivým způsobem.

- Jestliže káva vytéká příliš rychle nebo pěna nesplňuje vaše požadavky, otočte spínač o jeden dílek proti směru pohybu hodinových ruček.

**i** Nenastavujte otočný spínač nastavení stupně mletí do krajní polohy, protože při přípravě dvou šálků by káva vytékala po kapkách.

**i** Účinek těchto nastavení si uvědomíte teprve po následujících dvou přípravách kávy.

#### **Odstranění nežádoucích příměsí z mlýnku**

Tyto příměsi, jako např. kaménky, mohou vyvolat poškození mlýnku. Příměsi v kávě vyvolají stejnoměrně hlasitý rachotivý zvuk. Pokud v průběhu mletí uslyšíte tento zvuk, přístroj ihned vypněte a obraťte se na servisní středisko. **Na zablokování nebo poškození mlýnku nežádoucími příměsími se nevztahuje záruka.**

## 12 Nastavení teploty kávy

Teplotu můžete nastavit ve třech stupních. Ve výrobě je nastavena „Vysoká teplota“. Při nastavení postupujte následujícím způsobem:

- ☞** Stiskněte tlačítko „P“ (obr. 4).  
Symboly „P“ a ☞ se rozsvítí. Dále se nad tlačítka ☞, ☞ a ☞ rozsvítí tři malé symboly, které označují aktuální funkci těchto tlačítek – viz „Zvláštní režim“, str. 211.
- ☞** Tiskněte tlačítko Listování „<“ nebo „>“ (obr. 5), dokud se neobjeví symbol ↓.
- ☞** Potvrďte vybranou položku menu tlačítkem „OK“ (obr. 5).  
Displej zobrazí aktuální nastavení. Teploty jsou zobrazovány následujícím způsobem:
  - ☞ Nízká teplota
  - ☞ ☞ Střední teplota
  - ☞ ☞ ☞ Vysoká teplota

**☞** V případě potřeby zvolte tlačítka pro pohyb v menu „<“ nebo „>“ (obr. 5) jinou teplotu.

**☞** Zobrazenou teplotu potvrďte stisknutím tlačítka „OK“ (obr. 5). Tím je nastavena požadovaná teplota.

**i** Pokud nechcete hodnotu uložit, stiskněte „P“ místo „OK“.

**i** Pokud není stisknuto „OK“, přístroj se vrátí po cca. 120 sekundách automaticky do režimu přípravy kávy bez uložení údajů.

**☞** Do režimu přípravy kávy se vrátíte tlačítkem „P“ (obr. 4), nebo počkejte cca. 120 sekund, až se přístroj vrátí automaticky do režimu přípravy kávy.

## 13 Čištění a péče

Udržujte přístroj v čistotě, protože jen v takovém případě je zajištěna vysoká kvalita kávy a bezporuchový provoz.

### 13.1 Pravidelné čištění

**!** **Pozor!** Před čištěním přístroj vypněte. Vyčkejte, dokud přístroj nevychladne.

**!** **Pozor!** Přístroj ani jeho části nemyjte v myčce. Kávovar nesmí být ponořen do vody.





**!** **Pozor!** Do zásobníku na zrnkovou kávu nelijte vodu, protože by mohlo dojít k poškození mlýnku.

**!** Při čištění nepoužívejte ostré, drsné ani agresivní prostředky. Otřete vnější i vnitřní povrch přístroje vlhkým hadříkem.

**☞** Každý den vyjměte zásobník na vodu (obr. 6) a vylijte zbytek vody. Vypláchněte zásobník na vodu čerstvou vodou. Vždy používejte čerstvou vodu.





**☞** Každý den je třeba vyprázdnit nádobku na kávovou sedlinu, popř. nejspíše, jakmile se na displeji objeví výzva k vyprázdnění nádobky – viz „Vyprázdnění nádobky na kávovou sedlinu“, str. 220.

CZ



-  Pravidelně vyprazdňujte odkapávací misku. Misku je bezpodmínečně nutné vyprázdnit, jakmile se objeví červený plovák misky (obr. 28), v otvoru v odkapávací mřížce.
-  Čištění provádějte pravidelně, avšak nejméně jednou týdně. Omyjte teplou vodou, mycím prostředkem a popř. očistěte štětcem zásobník na vodu (N), odkapávací misku (O), odkapávací mřížku (A) a nádobku na kávovou sedlinu (Q).
-  Po každém napěnění mléka vyjměte parní trysku a důkladně ji očistěte, abyste odstranili zbytky mléka – viz „Vyčištění parní trysky“, str. 218.
-  Zkontrolujte, zda otvory výtoku kávy nejsou ucpané. Při čištění můžete zaschlou usazenou kávu odstranit jehlou (obr. 29).

### 13.2 Vyprázdnění nádoby na kávovou sedlinu

Jakmile přístroj připraví čtrnáctkrát jednotlivý šálek kávy (nebo sedmkrát dva šálky kávy), rozsvítí se symbol , který upozorňuje, že nádobka na kávovou sedlinu je plná a musí být vyprázdněna a vyčištěna. Dokud nevyprázdníte nádobku na kávovou sedlinu, kávovar nemůže připravit kávu.

-  Při čištění odjistěte servisní dvířka stisknutím příslušného tlačítka a otevřete je (obr. 30). Rozsvítí se symbol .
-  Vyjměte odkapávací nádobku (obr. 31), vyprázdněte ji a vyčistěte.
-  Vyprázdněte nádobku na kávovou sedlinu a pečlivě ji vyčistěte. Odstraňte veškeré usazeniny na dně.



**Důležité upozornění:** Při každém vyjmutí odkapávací nádoby, **je nutno** vyprázdnit rovněž nádobku na kávovou sedlinu, a to i když ještě není plná. Pokud ji nevyprázdníte, může při příští přípravě kávy dojít k přeplnění nádoby na kávovou sedlinu a ucpaní kávovaru.

 Jakmile vyjmete odkapávací nádobku, začne blikat symbol .

 Při každodenním používání přístroje vyprazdňujte nádobku každý den. Vyprázdněte nádobku na kávovou sedlinu vždy, když je přístroj zapnutý. Pouze v takovém případě, přístroj pozná, že jste nádobku vyčistili.

### 13.3 Čištění mlýnku

Ze zásobníku na zrnkovou kávu lze odstranit zbytky kávy měkkým štětcem nebo vysavačem.

-  **Pozor!** Do mlýnku nelijte vodu, protože by mohlo dojít k jeho poškození.
-  Vypněte přístroj tlačítkem „Zapnout/vypnout“ (obr. 11) a hlavním vypínačem (obr. 8). Vytáhněte síťovou vidlici ze zásuvky.
-  Odstraňte zbytky zrnkové kávy (např. použijte vysavač s hadicí a sací štěrbinou).

 Pokud nelze odstranit nežádoucí příměsi, obraťte se na servis. **Na zablokování nebo poškození mlýnku nežádoucími příměsmi se nevztahuje záruka.**

 **Pozor!** Je-li mlýnek v chodu, hrozí nebezpečí úrazu. V žádném případě přístroj nezapínejte při čištění mlýnku. Mohlo by dojít k závažnému úrazu. Vytáhněte síťovou vidlici ze zásuvky.





 Nasypte do mlýnku malé množství kávových zrn a zkontrolujte funkci mlýnku tím, že spustíte přípravu kávy. Při prvním mletí nebo po čištění pronikne do spařovací jednotky menší množství mleté kávy, protože musí být naplněna násypka. To může ovlivnit přípravu prvního šálku kávy.

### 13.4 Čištění spařovací jednotky

Doporučujeme pravidelně čistit spařovací jednotku (v závislosti na způsobu používání). Pokud jste přístroj nepoužívali delší dobu (např. po dobu dovolené), je nutné vyprázdnit nádobku na kávovou sedlinu a

zásobník na vodu a přístroj včetně spařovací jednotky důkladně vyčistit.



Postupujte následujícím způsobem:

-  Stisknutím tlačítka „Zapnout/vypnout“ (obr. 11) vypněte kávovar (nevytahujte síťovou vidlici ze zásuvky) a vyčkejte, dokud nezhasnou všechny symboly!
-  Odjistěte servisní dvířka stisknutím příslušného tlačítka a otevřete je (obr. 30).
-  Vyjměte odkapávací nádobku a nádobku na kávovou sedlinu (obr. 31) a vyčistěte je.
-  Obě červená uvolňovací tlačítka spařovací jednotky na stranách stiskněte směrem ke středu (obr. 32) a jednotku vytáhněte.

 **Upozornění: Spařovací jednotku lze vytáhnout pouze v případě, že přístroj je vypnutý tlačítkem „Zapnout/vypnout“ (1), které je umístěno na přední části přístroje. Přístroj by neměl být odpojen od elektrické sítě. Pokud se pokusíte vyjmout spařovací jednotku ze zapnutého přístroje, mohlo by dojít k jejímu vážnému poškození.**

-  Spařovací jednotku očistěte pod tekoucí vodou bez použití mycích přípravků. **Spařovací jednotku ne-myjte v myčce na nádobí.**
-  Vnitřek přístroje pečlivě vyčistěte. Kávové usazeniny v přístroji odstraňte dřevěnou či plastovou vidličkou apod., abyste nepoškodili a nepoškrábali povrch přístroje (obr. 33), a poté odstraňte veškeré zbytky vysavačem (obr. 34).
-  Při opětovné montáži zasuňte spařovací jednotku (obr. 36, a) do držáku (obr. 36, b), přičemž dbejte na správné zasunutí kolíku (obr. 36, c). Kolík musí zapadnout do trubky (obr. 36, d) na spodní straně spařovací jednotky.
-  Nyní tiskněte nápis PUSH (obr. 36, e), dokud spařovací jednotka neza-

skočí se slyšitelným zvukem do provozní polohy.

-  Jakmile uslyšíte, že jednotka zaskočila do provozní polohy, zkontrolujte, zda jsou červená tlačítka (obr. 36, f) vysunutá, protože v opačném případě není možné zavřít servisní dvířka. Obr. 37: Obě červená tlačítka jsou správně vysunutá.
- Obr. 38: Obě červená tlačítka nejsou správně vysunutá.
-  Vložte do přístroje odkapávací nádobku a nádobku na kávovou sedlinu.
-  Zavřete servisní dvířka.

 Jestliže spařovací jednotka není správně nasazena, tzn. ozve se jen jedno zaklapnutí a červená tlačítka nejsou správně vysunuta, není možné zavřít servisní dvířka.

 V případě, že spařovací jednotku lze namontovat jen s obtížemi, je třeba upravit její výšku. Před nasazením ji z obou stran stlačte tak, jak to ukazuje obr. 35.

 Pokud ji nelze ani potom zasunout do provozní polohy, zavřete servisní dvířka, vytáhněte síťovou vidlici ze zásuvky a znovu ji zapojte. Vyčkejte, dokud nezhasnou všechny symboly, otevřete servisní dvířka a zasuňte spařovací jednotku do přístroje.











### 13.5 Spuštění odvápnovacího programu

Odvápnovací program zajišťuje jednoduché a účinné odvápnění přístroje. Jestliže se symbol rozsvítí , je třeba přístroj odvápnit.









 **Upozornění:** V žádném případě nepoužívejte odvápnovací prostředek, který není doporučen společností AEG/Electrolux. Při používání jiných odvápnovacích prostředků společnost AEG/Electrolux nemůže ručit za případné škody. Odvápnovací přípravek obdržíte ve specializovaných pro-

CZ

dejnách nebo si ho objednejte na servisní lince AEG/Electrolux.

-  Odvápňení trvá cca. 45 minut a nesmí být přerušeno. V případě, že dojde k výpadku sítě, je nutné program znovu spustit.
-  Před spuštěním odvápňovacího programu vyčistěte spařovací jednotku (viz „Čištění spařovací jednotky“, str. 220).
-  Stiskněte tlačítko „P“ (obr. 4). Symboly „P“ a ☰ se rozsvítí. Dále se nad tlačítky ☰, ☱ a ☲ rozsvítí tři malé symboly, které označují aktuální funkci těchto tlačítek – viz „Zvláštní režim“, str. 211.
-  Tiskněte tlačítko Listování „<“ nebo „>“ (obr. 5), dokud se neobjeví symbol ☰.
-  Potvrďte volbu tlačítkem „OK“ (obr. 5). Symboly ☰ a ☲ blikají a „P“ svítí nepřerušovaně.
-  Chcete-li přerušit odvápňovací program, vypněte přístroj tlačítkem „Zapnout/vypnout“ ⏻ (obr. 11).
-  Vyprázdněte zásobník na vodu, nalijte do něj alespoň 1 litr vody a přidejte odvápňovací prostředek.
-  **Upozornění:** Přesvědčete, že případně odstříkující kapky odvápňovacího prostředku nemohou dopadnout na povrch, který by mohla kyselina poškodit, jako např. mramor, vápěnc a keramika.
-  Postavte nádobku o objemu min. 1,5 l pod parní trysku (obr. 9).
-  Nastavte otočný spínač pro páru a horkou vodu do polohy ☰☱☲. Tím spustíte odvápňovací program a odvápňovací roztok začne vytékat z parní trysky. Symboly ☰, ☲ a „P“ svítí nepřerušovaně. Odvápňovací program několikrát s přestávkami automaticky propláchně kávovar, aby usazeniny byly z přístroje dokonale odstraněny.

Po cca. 30 minutách je zásobník na vodu prázdný. Symboly ☰ a ☲ blikají a „P“ svítí nepřerušovaně.

-  Nastavte otočný spínač pro páru a horkou vodu do polohy ●. Přístroj je nyní připraven k propláchnutí čerstvou vodou.
-  Vyjměte zásobník na vodu, naplňte ho čerstvou vodou a znovu ho vložte do přístroje.
-  Nádobku pod parní tryskou vyprázdněte a znovu ji postavte pod parní trysku.
-  Nastavte otočný spínač pro páru a horkou vodu do polohy ☰☱☲. Spustí se proplachování čerstvou vodou, přičemž proplachovací voda vyteče parní tryskou. Symboly ☰, ☲ a „P“ svítí nepřerušovaně. Po několika minutách je zásobník na vodu prázdný. Symboly ☰ a ☲ blikají a „P“ svítí nepřerušovaně.
-  Nastavte otočný spínač pro páru a horkou vodu do polohy ●. Rozsvítí se symboly podle posledního zvoleného režimu přípravy kávy a symbol ☰ svítí nepřerušovaně.
-  Vylijte proplachovací vodu z nádoby.
-  Vyjměte zásobník na vodu, naplňte ho čerstvou vodou a znovu ho zasuňte do přístroje. Přístroj je nyní opět připraven k provozu a ve stavu naposledy zvoleného režimu přípravy kávy.
-  Po provedení odvápňovacího programu doporučujeme vylít šálek kávy, který byl připraven jako první.

## 14 Objednávání příslušenství

Pokud vám má přístroj sloužit k plné spokojenosti a chcete-li předejít závadám, je nezbytné ho pravidelně čistit a odvápnovat. Originální odvápnovací prostředek můžete získat přímo u nás.



V Německu se laskavě obračejte na naši objednávkovou telefonní horkou linku

1801 - 20 30 60\*



(\*Místní sazba v pevné síti Deutsche Telekom) od pondělí do pátku od 8.00 do 18.00 hod.

## 15 Co dělat, když se na displeji objeví následující hlášení...

### Symbol svítí nepřerušovaně

- Zásobník na vodu je prázdný nebo je nesprávně nasazen.
-  Doplníte vodu do zásobníku a správně ho zasuňte do přístroje – viz „Doplňování vody“, str. 211.
- Zásobník na vodu je znečištěný nebo se v něm vytvořily vápenné usazeniny.
-  Vypláchněte ho anebo odstraňte vápenné usazeniny.

### Symbole a blikají

- Kávovar nemůže připravit kávu.
-  Postavte nádobku pod parní trysku a nastavte otočný spínač pro páru a horkou vodu proti směru pohybu hodinových ruček do polohy  (obr. 9).
- Káva vytéká pomalu.
-  Nastavte spínač pro volbu stupně mletí (obr. 12) o jeden dílek ve směru pohybu hodinových ruček, dokud mlýnek mele zrnkovou kávu v průběhu přípravy kávy (viz „Nastavení stupně mletí“, str. 218).

### Symbol svítí nepřerušovaně

- Nádobka na kávovou sedlinu je plná:
-  Nádobku vyprázdněte podle pokynů v „Vyprázdnění nádoby na kávovou sedlinu“, str. 220, vyčistěte ji a správně nasadte do přístroje.



### Symbol bliká

- Nádobka na kávovou sedlinu nebyla po očištění vložena do přístroje.
-  Otevřete servisní dvířka a vložte do přístroje nádobku.

### Symbole nebo a blikají

- Po volbě funkce při přípravu nápoje z mleté kávy nebyla do násypky nasypána mletá káva.
-  Doplníte mletou kávu podle „Příprava nápoje z mleté kávy“, str. 216.

### Všechny symboly síly kávy a blikají

- Zásobník na zrnkovou kávu je prázdný.
-  Naplníte zásobník na zrnkovou kávu – viz „Nasypání zrnkové kávy do zásobníku“, str. 211.
- Jestliže mlýnek je příliš hlučný, může být zablokovaný kaménkem, který se dostal mezi kávová zrna.
-  Obrat'te se na servis. **Na zablokování nebo poškození mlýnku nežádoucími příměsmi se nevztahuje záruka.**

### Symbol svítí nepřerušovaně



- Hlášení upozorňuje, že se v kávovaru vytvořily vápenné usazeniny.
-  Proveďte co nejrychleji odvápnovací program popisovaný v části „Spuštění odvápnovacího programu“, str. 221.

### Symbol svítí nepřerušovaně

- Servisní dvířka jsou otevřená.
-  Zavřete servisní dvířka. Pokud servisní dvířka nelze zavřít, příčinou může být nesprávně nasazená spařovací jednotka (viz „Čištění spařovací jednotky“, str. 220)

CZ



**Symbol  bliká**

- Pravděpodobně jste zapomněli po očištění vložit do přístroje spařovací jednotku.
-  Vložte do přístroje spařovací jednotku – viz „Čištění spařovací jednotky“, str. 220.
- Vnitřek přístroje je velmi znečištěný.
-  Vnitřek přístroje pečlivě vyčistěte – viz „Čištění spařovací jednotky“, str. 220. Pokud i po očištění hlášení nezmizí, obraťte se laskavě na servis.

**Symbol  nepřerušovaně**

- Symbol signalizuje všeobecný alarm.
-  Obrat'te se laskavě na servis.

**Symbole  a  blikají**

- Přístroj byl zapnut otočným spínačem pro páru a horkou vodu, který byl nastaven do polohy „Otevřeno“ .
-  Nastavte otočný spínač pro páru a horkou vodu ve směru pohybu hodinových ruček (obr. 10) do krajní polohy .

**Symbole  a  blikají**

- Okolní teplota je příliš nízká, aby přístroj mohl být uveden do provozu.
-  Přístroj použijte v teplé místnosti.

**16 Obtíže, které se můžete pokusit odstranit, než se obrátíte na servis**



Jestliže kávovar není funkční, můžete se pokusit zjistit záadu a odstranit ji podle kapitoly „Co dělat, když se na displeji objeví následující hlášení...“, str. 223. V případě, že se na kávovaru nerozsvítí žádný symbol, proveďte následující kontroly, než se obrátíte na servis.

**Káva není horká**

- Šálky nebyly předeřhřáty.
-  Šálky je třeba předeřhřát. Vypláchněte je horkou vodou anebo je alespoň na 20 minut postavte na ohřívanou mříž-

ku pro odkládání šálků (H) (viz „Tipy pro přípravu teplejší kávy“, str. 215).

**Na kávě je vytvořena nedostatečná pěna**

- Káva je namleta příliš hrubě.
-  Nastavte spínač pro volbu stupně mletí o jeden dílek proti směru pohybu hodinových ruček, dokud v průběhu přípravy nápoje mlýnek mele zrnkovou kávu (viz „Nastavení stupně mletí“, str. 218).
- Směs není vhodná.
-  Použijte směs určenou pro kávovar.

**Káva vytéká příliš pomalu**

- Káva je namleta příliš jemně.
-  Nastavte spínač pro volbu stupně mletí o jeden dílek ve směru pohybu hodinových ruček, dokud v průběhu přípravy nápoje mlýnek mele zrnkovou kávu (viz „Nastavení stupně mletí“, str. 218).

**Káva vytéká příliš rychle**

- Káva je namleta příliš hrubě.
-  Nastavte spínač pro volbu stupně mletí o jeden dílek proti směru pohybu hodinových ruček, dokud v průběhu přípravy nápoje mlýnek mele zrnkovou kávu (viz „Nastavení stupně mletí“, str. 218).

**Káva vytéká pouze z jednoho otvoru výtoku**

- Otvory výtoku jsou ucpané.
-  Zaschlou kávu odstraňte jehlou (obr. 29).

**Ačkoli jste nastavili otočný spínač pro páru a horkou vodu, z parní trysky nevychází pára**

- Malé otvory v parní trysce a vnitřní část parní trysky jsou ucpané.
-  Vyčistěte malé otvory v parní trysce a vnitřní část parní trysky (viz „Vyčistění parní trysky“, str. 218).



**Pokud zvolíte funkci ☞ nebo ☞, nevytéká z přístroje káva, nýbrž voda**

- Mletá káva zůstala v násypce.
- ☞ Kávu v ucpané násypce uvolněte nožem (viz „Příprava nápoje z mleté kávy“, str. 216) (obr. 22). Vyčistěte spařovací jednotku a přístroj (viz „Čištění spařovací jednotky“, str. 220).

**Při stisknutí tlačítka ① se přístroj nezapne**

- Hlavní vypínač na zadní straně není zapnutý (obr. 8) nebo síťová vidlice není zapojena do zásuvky.
- ☞ Zkontrolujte, zda se hlavní vypínač nachází v poloze „I“ a zda je síťový kabel zapojen do zásuvky.

**Spařovací jednotku nelze při čištění vyjmout z přístroje**

- Kávovar je zapnutý. Spařovací jednotku lze vyjmout z kávovaru pouze v případě, že je přístroj vypnutý.
- ☞ Vypněte přístroj a vyjměte spařovací jednotku (viz „Čištění spařovací jednotky“, str. 220).

- i** **Upozornění: Spařovací jednotku lze vytáhnout pouze v případě, že přístroj je vypnutý tlačítkem „Zapnout/vypnout“ ①, které je umístěno na přední části přístroje. Přístroj by neměl být odpojen od elektrické sítě. Pokud se pokusíte vyjmout spařovací jednotku ze zapnutého přístroje, mohlo by dojít k jejímu vážnému poškození.**

**Káva nevytéká z výtoku, nýbrž kolem servisních dvířek**

- Otvory výtoku jsou zaneseny zaslou kávou.
- ☞ Zaslou kávu odstraňte jehlou (obr. 29).
- Na vnitřní straně servisních dvířek se nachází výklopná přihrádka (R), která je zablokována a nepohybuje se.
- ☞ Výklopnou přihrádku pečlivě vyčistěte, především okolí závěsů, aby byla zajištěna pohyblivost.

**K přípravě kávy byla použita mletá káva (místo zrnkové kávy) a z přístroje nevytéká káva.**

- Do přístroje jste nasypali příliš velké množství mleté kávy.
- ☞ Vyjměte spařovací jednotku a vnitřek přístroje vyčistěte podle bodu „Čištění spařovací jednotky“, str. 220. Celý postup opakujte a do přístroje nasypejte nejvýše dvě zarovnané odměrky.
- Otočný spínač „Síla kávy / mletá káva“ nebyl nastaven do polohy ☞ nebo ☞ přístroj používá současně mletou kávu i kávu rozemletou v mlýnku.
- ☞ Pečlivě vyčistěte vnitřek přístroje podle bodu „Čištění spařovací jednotky“, str. 220. Opakujte celý postup a nastavte otočný spínač do správné polohy „Síla kávy / mletá káva“ jako v bodě „Příprava nápoje z mleté kávy“, str. 216.
- Mletá káva byla doplněna do vypnutého přístroje.
- ☞ Vyjměte spařovací jednotku a vnitřek přístroje vyčistěte podle bodu „Čištění spařovací jednotky“, str. 220. Postup opakujte po zapnutí přístroje.

**Co dělat, když chcete přístroj přepravit na jiné místo?**

- Uschovejte originální obal, abyste v něm mohli přístroj přepravovat. Jako ochranu proti poškrábání je bezpodmínečně nutné používat originální fólii.
- Chraňte termokanvici proti nárazům. Záruka se nevztahuje na škody způsobené při přepravě.
- Vyprázdněte zásobník na vodu a nádobku na kávovou sedlinu.
- Laskavě zvažte, kam umístíte přístroj, především v chladných ročních obdobích. Přístroj může být poškozen mrazem.

CZ

## 17 Režim Statistika

Přístroj umožňuje vyvolat následující hodnoty:





- počet všech dosud připravených šálek,
- počet připravených konvic se 4 šálky, 6 šálky, 8 šálky a 10 šálky,
- počet provedených odvápnovacích cyklů a dále
- počet litrů vody, které kávovar nadávkoval.

**i** Jestliže jste připravili dva šálky kávy najednou, jsou započítány jako dva šálky.







Režim Statistika lze zvolit pouze u vypnutého přístroje.

**☞** Podle potřeby vypněte přístroj tlačítkem „Zapnout/vypnout“  (obr. 11).

**☞** Stiskněte tlačítko „P“ (obr. 4) nejméně na 6 sekund.

Symbole „P“ a  se rozsvítí. Dále se nad tlačítky ,  a  rozsvítí tři malé symboly, které označují aktuální funkci těchto tlačítek – viz „Zvláštní režim“, str. 211.





**☞** Tiskněte tlačítko Listování „<“ nebo „>“ (obr. 5), dokud se nerozsvítí symbol příslušného statistického údaje:

-  Počet připravených šálek kávy
-  Počet provedených odvápnovacích cyklů
-  Počet připravených konvic se 4 šálky
-  Počet připravených konvic se 6 šálky
-  Počet připravených konvic se 8 šálky
-  Počet připravených konvic se 10 šálky
-  Počet nadávkovaných litrů vody

Pokud svítí některý symbol, můžete vyvolat příslušný počet následujícím způsobem:

**☞** Stiskněte tlačítko „OK“ a přidržte je ve stisknuté poloze (obr. 5).





Nyní začnou jednotlivé kontrolky postupně blikat a tím ukazují počet:

	1 bliknutí odpovídá 1
	1 bliknutí odpovídá 10
	1 bliknutí odpovídá 100
	1 bliknutí odpovídá 1,000
	1 bliknutí odpovídá 10,000

Blikání se průběžně opakuje, dokud tisknete tlačítko „OK“. Jednotlivé cykly jsou odděleny třísekundovou prodlevou.

**☞** Spočítejte počet jednotlivých bliknutí.

Příklad: Následující počet bliknutí vyjadřuje číslo 1529.

	9 bliknutí
	2 bliknutí
	5 bliknutí
	1 bliknutí
	žádné bliknutí

**☞** Režim Statistika opustíte stisknutím tlačítka „P“ (obr. 4), které je třeba přidržet nejméně 6 sekund.

## 18 Technické údaje

Síťové napětí: 220-240 V  
Příkon: 1350 W

**CE** Přístroj splňuje následující směrnice EU:

- 73/23/EHS z 19.2.1973 „Směrnice pro nízké napětí“ včetně pozměňovací směrnice 93/68/EHS.
- 89/336/EHS z 3.5.1989 „Směrnice pro elektromagnetickou kompatibilitu“ včetně pozměňovací směrnice 92/31/EHS.

## 19 Likvidace



### Obalový materiál

Obalové materiály nezatěžují životní prostředí a jsou recyklovatelné. Plastové díly jsou označeny, např. >PE<, >PS< atd. Tyto obalové materiály vyhod'te do příslušných kontejnerů podle označení na místech pro likvidaci komunálního odpadu.



### Vyřazený přístroj

Symbol  na výrobku nebo jeho obalu upozorňuje na to, že s tento výrobek nepatří do normálního domovního odpadu, nýbrž musí být odevzdán na sběrném místě pro recyklování elektrických a elektronických přístrojů. Správná likvidace tohoto výrobku představuje váš příspěvek k ochraně životního prostředí a zdraví spoluobčanů. Nesprávná likvidace ohrožuje životní prostředí i zdraví. Další informace o recyklaci tohoto výrobku vám poskytne obecní úřad, společnosti pro svoz odpadu nebo prodejna, v níž jste tento výrobek zakoupili.

## 20 Servis

Uschovejte originální obal včetně polystyrénových vložek. Přístroj musí být bezpečně zabalen, aby nedošlo k jeho poškození při přepravě.

Přístroj musí být vždy vrácen včetně termokonvice. Konvice je nutná pro zkoušení přístroje.

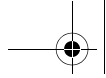

CZ

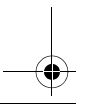
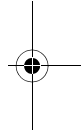
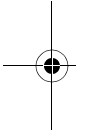

228

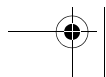
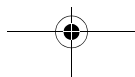

**PL WáŜszanowni klienci!**

Prosimy o dokładne przeczytanie tej instrukcji obsługi. A w szczególności wskazówek dotyczących bezpieczeństwa użytkowania! Instrukcję obsługi należy przechowywać w celu korzystania z niej w przyszłości lub przekazania jej ewentualnemu następnemu użytkownikowi tego urządzenia.

**Spis treści**

<b>1 Opis rysunku</b>	<b>230</b>	<b>10 Przygotowywanie gorącej wody</b>	<b>241</b>
1.1 Widok z przodu (rys. 1)	230	<b>11 Ustawianie stopnia mielenia</b>	<b>241</b>
1.2 Widok od przodu przy otwartych drzwiczkach serwisowych (rys. 2)	230	<b>12 Ustawianie temperatury kawy</b>	<b>242</b>
1.3 Panel obsługi (rys. 3)	230	<b>13 Czyszczenie i konserwacja</b>	<b>242</b>
<b>2 Kawa i kawa espresso</b>	<b>231</b>	13.1 Regularne czyszczenie	242
<b>3 Zasady bezpieczeństwa</b>	<b>231</b>	13.2 Opróżnianie pojemnika na fusy	243
<b>4 Tryb specjalny</b>	<b>233</b>	13.3 Czyszczenie młynka	243
<b>5 Pierwsze uruchomienie</b>	<b>233</b>	13.4 Czyszczenie komory zaparzania	244
5.1 Ustawienie i podłączenie urządzenia	233	13.5 Wykonywanie programu usuwania kamienia	245
5.2 Napełnianie wodą	233	<b>14 Zamawianie wyposażenia dodatkowego</b>	<b>246</b>
5.3 Napełnianie pojemnika na kawę ziarnistą	233	<b>15 Co zrobić, jeżeli na wyświetlaczu pojawi się następujący komunikat...</b>	<b>246</b>
5.4 Pierwsze włączenie	234	<b>16 Problemy, które można samodzielnie rozwiązać przed wezwaniem serwisu</b>	<b>247</b>
5.5 Włączanie urządzenia	234	<b>17 Tryb statystyki</b>	<b>249</b>
5.6 Wyłączanie urządzenia	235	<b>18 Dane techniczne</b>	<b>250</b>
5.7 Ustawianie twardości wody	235	<b>19 Utylizacja</b>	<b>250</b>
<b>6 Przygotowywanie naparu z kawy ziarnistej</b>	<b>236</b>	<b>20 W przypadku naprawy</b>	<b>250</b>
6.1 Co zrobić, aby kawa była bardziej gorąca	237		
<b>7 Przygotowywanie większej ilości filiżanek za pomocą funkcji dzbanka</b>	<b>238</b>		
<b>8 Przygotowywanie naparu z kawy sypkiej</b>	<b>238</b>		
<b>9 Spienianie mleka</b>	<b>239</b>		
9.1 Czyszczenie dyszy	241		

PL

## 1 Opis rysunku















### 1.1 Widok z przodu (rys. 1)

- A** Kratka ociekowa
- B** Dzbaneł podtrzymujący ciepłó
- C** Wyłącznik główny (z tyłu urządzenia)
- D** Wylót kawy o regulowanej wysokości
- E** Panel obsługi (patrz rys. 3)
- F** Pokrywa pojemnika na kawę ziarnistą
- G** Pokrywa pojemnika na mieloną kawę
- H** Ogrzewana podstawał na filiżankę
- J** Rurka obrotowa na parę i gorącą wodę
- K** Dysza parowa (zdejmowana)
- L** Część wewnętrzna dyszy parowej (zdejmowana)
- M** Przycisk do otwierania drzwiczek serwisowych
- N** Pojemnik na wodę ze znakiem poziomu Max (wyjmowany)
- O** Podstawał ociekowa z pływakiem (wyjmowana)

### 1.2 Widok od przodu przy otwartych drzwiczkach serwisowych (rys. 2)

- P** Drzwiczki serwisowe (otwarte)
- Q** Pojemnik na fusy (wyjmowany)
- R** Półka obrotowa
- S** Zaparzacł
- T** Przełącznik zmiany stopnia mielenia
- U** Pojemnik na kawę ziarnistą
- V** Miarka
- W** Otwór wysypowy na mieloną kawę
- X** Tabliczka znamionowa (spód urządzenia)
- Y** Odkamieniacł w płynie
- Z** Pasek testowy

### 1.3 Panel obsługi (rys. 3)

- a** Pokrętló „Moc kawy / kawa mielona”
- b** Pokrętló „Wielkość filiżanki”
- c** Wyświetlacł
- d** Przycisk „1 filiżanka kawy”   
W trybie specjalnym przycisk ten służy do przeglądania („<”)
- e** Przycisk „2 filiżanki kawy”   
W trybie specjalnym przycisk ten służy do przeglądania („>”)
- f** Przycisk „Para”   
W trybie specjalnym przycisk ten służy do potwierdzania punktu menu („OK”)
- g** Przycisk „P”  
W trybie specjalnym przycisk ten służy do powrotu do ostatniego poziomu bez wprowadzania zmian („P”)
- h** Przycisk „Wł./Wyt.” 
- j** Rurka obrotowa na parę i gorącą wodę
- k** Przycisk „Dzbaneł” 
- l** Symbol „Zmielona kawa”
- m** Symbol „Dzbaneł”
- n** Symbol „Moc naparu kawy”
- o** Symbol „Wielkość filiżanki”
- p** Symbol „Pojemnik na wodę pustą” 
- q** Symbol „Odwapnianie” 
- r** Symbol „Temperatura urządzenia” 
- s** Symbol „Drzwiczki serwisowe otwarte” 
- t** Symbol „Pojemnik na fusy” 
- u** Symbol „Uwaga” 
- v** Symbol „Gorąca woda” 
- w** Symbol „Para” 
- x** Symbol „2 filiżanki kawy” 
- y** Symbol „1 filiżanka kawy” 
- z** Symbole trybu specjalnego

## 2 Kawa i kawa espresso

Zasada działania tego automatu do kawy gwarantuje bardzo prostą **obsługę**, zarówno przy przyrządzaniu kawy, jak i konserwacji i pielęgnacji urządzenia.

Znakomity i indywidualnie dobrany **smak kawy** dzięki

- systemowi wstępnego zaparzania: temu, że przed właściwym zaparzeniem zmielona kawa zostaje zwilżona, aby wydobyć cały jej aromat,
- indywidualnemu doborowi ilości wody – od małych, „krótkich” filiżaneczek espresso po duże, „długie” filiżanki kawy z pianką,
- indywidualnemu wyborowi temperatury wody zaparzającej kawę,
- możliwości wyboru pomiędzy normalnym a mocnym naparem kawy,
- stopniowi mielenia dostosowanemu do stopnia wyprażenia kawy,
- a nawet dzięki gwarantowanej „piankowej koronie” Crema, która dla znawców kawy espresso czyni ją jedyną w swoim rodzaju.

Ponadto: Czas zaparzania zmielonej kawy jest w przypadku kawy espresso znacznie krótszy niż w przypadku zwyczajnego zaparzania kawy z użyciem filtra. Dzięki temu do naparu przechodzi mniej goryczy, co czyni kawę espresso znacznie łagodniejszą!

## 3 Zasady bezpieczeństwa



Bezpieczeństwo tego urządzenia odpowiada ogólnie stosowanym przepisom technicznym i zasadom dotyczącym bezpieczeństwa sprzętu. Jednak jako producent tego urządzenia zalecamy szczególnie stosowanie się do poniższych zasad bezpieczeństwa.

### Ogólne zasady bezpieczeństwa

- Sprzęt ten można podłączać tylko do źródła zasilania, którego napięcie jest zgodne z podanym na tabliczce znamionowej (patrz: spód urządzenia)!
- Chronić przewód zasilający przed stykaniem się z gorącymi elementami urządzenia.
- Wtyczka przewodu zasilającego nigdy nie powinna być wyjmowana z gniazdka przez pociąganie za przewód!
- Nie włączać urządzenia w przypadku, gdy:
  - przewód zasilający jest uszkodzony lub
  - na obudowie widać wyraźne ślady uszkodzenia.
- Wtyczkę przewodu zasilającego włączać do gniazda tylko wtedy, gdy urządzenie jest wyłączone.
- Urządzenie nie jest przeznaczone dla osób (w tym dzieci), które z powodu braku doświadczenia lub stosownej wiedzy nie są w stanie zapewnić bezpiecznego użytkowania, ani też dla osób (w tym dzieci) niepełnosprawnych fizycznie, sensorycznie lub umysłowo, chyba że osoby te zostały odpowiednio poinstruowane, jak należy poprawnie obchodzić się z urządzeniem i były od początku nadzorowane przez osoby sprawujące nad nimi opiekę.

### Zagrożenie dla dzieci

- **Nigdy nie należy pozostawiać włączonego sprzętu bez nadzoru; należy zachować szczególną ostrożność w obecności dzieci!**

PL

- Materiałów opakowaniowych, np. worków foliowych, nie należy oddawać dzieciom do zabawy.

#### **Bezpieczeństwo w trakcie użytkowania**

- **Uwaga! Otwór wypływu kawy, dysza parowa i tacka na filiżanki są podczas pracy urządzenia gorące. Należy chronić przed dostępem do nich dzieci!**
- **Uwaga! Niebezpieczeństwo poparzenia podczas wypływu pary! Wypływająca gorąca woda, względnie gorąca para wodna, może spowodować poparzenie. Dyszę parową należy włączać tylko wtedy, gdy znajduje się pod nią jakiś pojemnik.**
- Nie wolno podgrzewać parą żadnych łatwopalnych płynów!
- Urządzenie można używać tylko wtedy, gdy znajduje się w nim woda! Pojemnik na wodę wypełniać tylko zimną wodą, **nigdy wodą gorącą, mlekiem ani innymi płynami.** Maksymalne wypełnienie pojemnika wynosi ok. 1,8 litra.
- **Do pojemnika na kawę ziarnistą wsypywać tylko paloną kawę – nie wsypywać kawy mrożonej ani kawy z dodatkiem cukru! Z kawy ziarnistej należy usunąć wszelkie obce ciała, np. drobne kamyki. Zablokowanie lub uszkodzenie młynka przez ciała obce nie jest objęte gwarancją.**
- Do pojemnika na kawę sypką wsypywać tylko kawę mieloną.
- Nie pozostawiać bez potrzeby włączzonego urządzenia.
- Nie narażać urządzenia na wpływ warunków pogodowych.
- W przypadku konieczności zastosowania przedłużacza używać wyłącznie przedłużaczy dostępnych w handlu, o przekroju co najmniej 1,5 mm<sup>2</sup>.
- Aby uniknąć zagrożenia, osoby o ograniczonej sprawności motorycznej nigdy nie powinny korzystać z urządzenia bez nadzoru.

- **Urządzenie używać tylko z założoną podstawką ociekową, pojemnikiem na fusy i kratką ociekową!**

#### **Bezpieczeństwo podczas czyszczenia i konserwacji**

- Stosować się do wskazówek dotyczących czyszczenia i usuwania kamienia.
- Przed rozpoczęciem czynności konserwacyjnych i czyszczenia wyłączyć urządzenie i wyjąć wtyczkę z sieci!
- Nie zanurzać urządzenia w wodzie.
- Dyszę wylotu pary czyścić tylko wtedy, gdy urządzenie jest wyłączone, zimne i nie pod ciśnieniem!
- Części urządzenia nie czyścić w zmywarce do naczyń.
- **Nie wlewać wody do młynka**, ponieważ spowoduje to jego uszkodzenie.

Urządzenia nie wolno samodzielnie rozkręcać ani naprawiać. Niefachowa naprawa może spowodować poważne zagrożenia dla użytkownika.

Elektryczne urządzenia mogą być naprawiane wyłącznie przez przeszkolony personel!



W przypadku konieczności naprawy, w tym wymiany kabla zasilającego, należy zwrócić się do



- punktu sprzedaży, w którym urządzenie zostało zakupione lub
- do serwisu firmy AEG/Electrolux.

**W przypadku niezgodnego z przeznaczeniem lub niewłaściwego użytkowania urządzenia producent nie udziela gwarancji, ani nie ponosi odpowiedzialności za ewentualne szkody – również wtedy, gdy program odkamieniania nie był wykonywany zaraz po pojawieniu się symbolu ☞ zgodnie z zaleceniami niniejszej instrukcji obsługi. Zablokowanie lub uszkodzenie młynka przez ciała obce nie jest objęte gwarancją.**



## 4 Tryb specjalny

Aby ustawić twardość wody („Ustawianie twardości wody”, strona 235), temperaturę naparu kawy („Ustawianie temperatury kawy”, strona 242), włączyć program odkamieniania („Wykonywanie programu usuwania kamienia”, strona 245) oraz przejrzeć statystykę („Tryb statystyki”, strona 249) za pomocą przycisku „P” (rys. 4) przechodzi się do trybu specjalnego. W trybie specjalnym do nawigacji służą przyciski „1 filiżanka kawy” , „2 filiżanki kawy” , „Para”  i „P”. Dana funkcja jest podana na wyświetlaczu nad przyciskiem (rys. 5):

- „<” („1 filiżanka kawy” ) i „>” („2 filiżanki kawy” ) umożliwiają przeglądanie menu
- „OK” („Para” ) potwierdza punkt menu
- „P” („P”) – powrót do ostatniego poziomu bez wprowadzania zmian

## 5 Pierwsze uruchomienie

### 5.1 Ustawienie i podłączenie urządzenia

Do ustawienia należy wybrać odpowiednie, poziome, stabilne, niepodgrzewane, suche miejsce na wodoodpornym podłożu.

-  Należy zwrócić uwagę na dobrą wentylację. Po bokach i za urządzeniem należy zachować wolne miejsce min. 5 cm, a nad urządzeniem min. 20 cm. Urządzenia nie wolno wstawiać do pomieszczeń, w których może wystąpić temperatura równa lub niższa od 0 °C (urządzenie może ulec uszkodzeniu z powodu zamarznięcia wody).



-  Uwaga! W przypadku wniesienia urządzenia z zimna do ciepłego pomieszczenia należy odczekać ok. 2 godzin przed włączeniem go!

Zalecane jest umieszczenie odpowiedniej podkładki pod urządzeniem, aby uniknąć uszkodzeń spowodowanych rozpryskiwaniem.

-  Urządzenie należy podłączać wyłącznie do gniazdka z uziemieniem. Nie używać gniazdek bez uziemienia.

### 5.2 Napełnianie wodą

Przed każdym włączeniem należy upewnić się, czy w pojemniku na wodę znajduje się woda i uzupełnić go w razie potrzeby. Urządzenie potrzebuje wody przy każdym włączeniu i wyłączeniu do przeprowadzenia automatycznego płukania.

-  Wyjąć pojemnik na wodę (rys. 6). Przed wyjęciem pojemnika na wodę należy obrócić dyszę parową do środka urządzenia, ponieważ w przeciwnym razie nie będzie można wyjąć pojemnika.
-  Do pojemnika nalać świeżej, zimnej wody. Nie wlewać więcej wody, niż do poziomu znaku MAX.

-  Napełniać pojemnik tylko zimną wodą. Nie wlewać do pojemnika innych płynów, np. wody mineralnej lub mleka.

-  Włożyć pojemnik na wodę na swoje miejsce (rys. 6). Wcisnąć mocno pojemnik, aby zawór pojemnika wody otworzył się.

-  Aby zawsze uzyskiwać aromatyczną kawę, należy:
- zmieniać codziennie wodę w pojemniku na wodę,
  - co najmniej raz w tygodniu oczyścić pojemnik podczas normalnego zmywania (nie w zmywarce do naczyń). Następnie opłukać czystą wodą.

### 5.3 Napełnianie pojemnika na kawę ziarnistą

-  Odchylić pokrywę pojemnika na kawę i wypełnić go świeżą kawą ziarnistą (rys. 7). Następnie zamknąć pokrywę.

PL



**Uwaga!** Do pojemnika na kawę ziarnistą wsypywać tylko paloną kawę, nie wolno wsypywać kawy mrożonej lub z dodatkiem cukru! Należy upewnić się, że do pojemnika na kawę nie dostały się żadne ciała obce, np. kamyki. **Zablokowanie lub uszkodzenie młynka przez ciała obce nie jest objęte gwarancją.**



Fabrycznie młynek jest ustawiony na średni stopień grubość mielenia. W razie potrzeby ustawienie to można zmienić. Wskazówki dotyczące zmiany stopnia grubości mielenia znajdują się poniżej „Ustawianie stopnia mielenia”, strona 241.



**Stopień grubości mielenia może być zmieniony tylko podczas mielenia. Regulacja przy zatrzymanym młynku może spowodować uszkodzenie automatu do kawy.**



Automat do kawy został sprawdzony przez producenta. Do tego celu użyta została kawa, a więc w młynku mogą znajdować się jej pozostałości. Gwarantujemy, że Państwa automat jest nowy.

#### 5.4 Pierwsze włączenie

Przy pierwszym uruchomieniu urządzenia należy odpowietrzyć automat do kawy.



Włączyć urządzenie za pomocą wyłącznika głównego znajdującego się z tyłu urządzenia (rys. 8).

Przy pierwszym włączeniu wyłącznika głównego na wyświetlaczu przez kilka sekund wyświetlone zostają wszystkie symbole w celu wykonania autotestu, a następnie migają symbole i .



Napełnić pojemnik na wodę – patrz „Napełnianie wodą”, strona 233.



Włożyć pojemnik na wodę na swoje miejsce (rys. 6). Wcisnąć mocno pojemnik, aby zawór pojemnika wody otworzył się.



Należy przekręcić dyszę pary na zewnątrz i podstawić filiżankę (rys. 9).



Przekręcić pokrętko pary i gorącej wody do oporu w stronę przeciwną do ruchu wskazówek zegara na pozycję (rys. 10).

Z dyszy parowej wypływa niewielka ilość wody. Symbole i świecą w sposób ciągły.

Gdy filiżanka napełniona jest ok. 30 ml wody, symbole i zaczynają migać.



Przekręcić pokrętko pary i gorącej wody do oporu w stronę zgodną z ruchem wskazówek zegara na pozycję (rys. 10), aby zakręcić wypływ wody.

Symbol miga przez kilka sekund i urządzenie wyłącza się.



Napełnić pojemnik kawą ziarnistą – patrz „Napełnianie pojemnika na kawę ziarnistą”, strona 233.

#### 5.5 Włączanie urządzenia

Przed każdym włączeniem należy upewnić się, czy w pojemniku na wodę znajduje się woda i uzupełnić go w razie potrzeby. Urządzenie potrzebuje przy każdym włączeniu i wyłączeniu wody do przeprowadzenia automatycznego płukania.



Włączyć urządzenie za pomocą przycisku „Wł./Wyl” (rys. 11).



Bezpośrednio po włączeniu urządzenie ustawia się samoczynnie. Dające się wtedy słyszeć szmery są normalnym objawem.





Podczas podgrzewania wody (ok. 120 sekund) miga symbol .

Podczas podgrzewania urządzenie wykonuje płukanie w trybie automatycznym (niewielka ilość gorącej wody wypływa z otworu wypływu kawy i spada do podstawki ociekowej).

Po zakończeniu podgrzewania symbol świeci się w sposób ciągły.

Urządzenie jest teraz gotowe do pracy. Świecą się symbole zgodne z ostatnio wybranym trybem pracy.

## 5.6 Wyłączanie urządzenia

 Wyłączyć urządzenie za pomocą przycisku „Wł./Wyl.”  (rys. 11). Miga symbol . Urządzenie wykona operację płukania, a następnie wyłączy się.

 Jeśli urządzenie nie jest używane przez dłuższy czas, to ze względów ekonomicznych wyłączy się automatycznie po upływie 3 godzin.

 Jeżeli urządzenie nie będzie przez dłuższy czas używane, to po wyłączeniu przyciskiem „Wł./Wyl.” należy dodatkowo wyłączyć wyłącznik główny znajdujący się w tylnej części urządzenia (rys. 8).

## 5.7 Ustawianie twardości wody

Po pierwszym uruchomieniu lub przy zmianie jakości wody, urządzenie należy ustawić na właściwy stopień twardości wody, odpowiadający stopniowi twardości wody z lokalnego ujęcia. W tym celu należy użyć dołączonych do urządzenia pasków do oceny stopnia twardości wody lub zasięgnąć informacji u lokalnego dostawcy.

### Określenie stopnia twardości wody

 Zanurzyć pasek testowy na ok. 1 sekundę w zimnej wodzie. Strząsnąć nadmiar wody i określić stopień twardości wody na podstawie liczby zabarwionych na różowo pól.

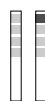
 **Brak** lub **jedno** różowe pole:  
**stopień twardości 1,**  
**woda miękka**  
do 1,24 mmol/l, wzgl.  
do 7° w niemieckiej skali twardości wody, wzgl.  
do 12,6° we francuskiej skali twardości wody

 **Dwa** różowe pola:  
**stopień twardości 2,**  
**woda średnio twarda**  
do 2,5 mmol/l, wzgl.  
do 14° w niemieckiej skali twardości wody, wzgl.  
do 25,2° we francuskiej skali twardości wody



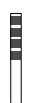

 **Trzy** różowe pola:  
**stopień twardości 3,**  
**woda twarda**  
do 3,7 mmol/l, wzgl.  
do 21° w niemieckiej skali twardości wody, wzgl.  
do 37,8° we francuskiej skali twardości wody

 **Cztery** różowe pola:  
**stopień twardości 4,**  
**woda bardzo twarda**  
ponad 3,7 mmol/l, wzgl.  
ponad 21° w niemieckiej skali twardości wody, wzgl.  
ponad 37,8° we francuskiej skali twardości wody

### Nastawianie i zapamiętanie określonego stopnia twardości wody











Można ustawić 4 stopnie twardości wody. Urządzenie jest ustawione fabrycznie na stopień twardości 4.

 Nacisnąć przy włączonym urządzeniu przycisk „P” (rys. 4).

Nacisnąć przy włączonym urządzeniu przycisk „P” (rys. 4). Świecą się symbole „P” i . Ponadto świecą się 3 małe symbole nad filizankami ,  i , które wskazują bieżącą funkcję filizanek, patrz „Tryb specjalny”, strona 233.

 Wybrać ten punkt menu, naciskając przycisk „OK” (rys. 5).

Wyświetlacz wskazuje bieżące ustawienie przyrządzania kawy. Ustawiona twardość wody jest wskazywana w podany niżej sposób:

 Stopień twardości 1  
  Stopień twardości 2  
   Stopień twardości 3  
    Stopień twardości 4

PL

 Naciskać przyciski przeglądania menu „<” lub „>” (rys. 5), tak często, aż pojawi się żądany stopień twardości.

 Wybrać ten punkt menu, naciskając przycisk „OK” (rys. 5). Ten stopień twardości zostanie zapamiętany.

 Aby przerwać bez zapisywania ustawień, należy nacisnąć przycisk „P” zamiast „OK”.

Jeżeli przycisk „OK” nie zostanie wciśnięty, urządzenie po ok. 120 sekundach automatycznie powróci do trybu przygotowania kawy bez zapisywania wprowadzonych ustawień.

 Aby powrócić do trybu przygotowywania kawy, należy nacisnąć przycisk „P” (rys. 4) lub odczekać około 120 sekund, aż urządzenie przełączy się automatycznie w ten tryb.

## 6 Przygotowywanie naparu z kawy ziarnistej

Następujący proces przygotowania kawy przy użyciu kawy ziarnistej przebiega w pełni automatycznie: Mielenie, porcjowanie, ugniatanie, wstępne zaparzenie, zaparzenie i wyrzucanie zużytych fusów kawy.





Dzięki możliwości ustawienia stopnia mielenia i ilości mielonego surowca, można dostosować urządzenie do indywidualnych upodobań smakowych.

 Do pojemnika na kawę ziarnistą wsypywać tylko paloną kawę, nie wolno wsypywać kawy mrożonej lub z dodatkiem cukru! Należy upewnić się, że do pojemnika na kawę nie dostały się żadne ciała obce, np. kamyki. **Zablokowanie lub uszkodzenie młynka przez ciała obce nie jest objęte gwarancją.**

W zależności od upodobania można ustawić pojemność na „krótką” filiżankę espresso lub „długą” filiżankę kawy z pianką.

 Wybrać żądaną wielkość filiżanki za pomocą pokrętki „Wielkość filiżanki” (rys. 12). Na wyświetlaczu pojawi się wybrana wielkość filiżanki.





Wielkość filiżanki jest wskazywana w następujący sposób:

 filiżanka espresso  
 mała filiżanka  
 średnia filiżanka  
 duża filiżanka  
 kubek



Można wybierać kawę bardzo łagodną, łagodną, normalną, mocną i bardzo mocną.



 Wybrać żądaną moc kawy za pomocą pokrętki „Moc kawy” (rys. 13). Na wyświetlaczu pojawi się wybrana moc kawy.

 Moc naparu kawy wskazywana jest w następujący sposób:



 bardzo łagodna  
 łagodna  
 normalna  
 mocna  
 bardzo mocna



 Postawić jedną lub dwie filiżanki pod otworami wypływu kawy (rys. 14). Przez uniesienie lub opuszczenie wypływu można dopasować wysokość wypływu do wysokości filiżanki, aby wypływająca kawa nie ochładzała się i nie przyskała (rys. 15).



 Nacisnąć przycisk „1 filiżanka kawy” , aby przyrządzić 1 filiżankę, lub „2 filiżanki”  aby przyrządzić 2 filiżanki.



Świeci się symbol „1 filiżanka”  lub „2 filiżanki” . Urządzenie miele teraz ziarno. W procesie wstępnego zaparzenia zmielona kawa zostaje zwilżona niewielką ilością wody. Po krótkiej przerwie rozpoczyna się właściwe zaparzenie. Kawa zostanie nalana do filiżanki.

Po nalaniu żądanej ilości kawy urządzenie automatycznie zakończy jej nalewanie, a zużyte fusy zostaną



wyrzucone do odpowiedniego pojemnika. W tym czasie miga symbol „1 filiżanka”  lub „2 filiżanki” .



 Nalewanie kawy można zawsze zakończyć wcześniej poprzez ponowne naciśnięcie przycisku „1 filiżanka”  lub „2 filiżanki”  lub obrócenie pokrętkiem „Wielkość filiżanki” (rys. 12) w kierunku przeciwnym do ruchu wskazówek zegara, w kierunku „Filiżanka espresso”.



 Po zakończeniu nalewania kawy można zwiększyć jej ilość naciskając przycisk „1 filiżanka”  lub „2 filiżanki” , który należy przytrzymać, aż nalana zostanie żądana ilość kawy, lub też obracając pokrętkiem „Wielkość filiżanki” (rys. 12) w kierunku zgodnym z ruchem wskazówek zegara w stronę symbolu „Kubek” (musi to nastąpić bezpośrednio po nalaniu kawy, ale jeszcze przed wyrzuceniem zużytych fusów do pojemnika).



Po kilku sekundach, gdy zgaśnie symbol „1 filiżanka”  lub „2 filiżanki” , urządzenie będzie znowu gotowe do pracy i przyrządzenia następnej kawy.

 Jeżeli kawa wypływa kroplami, niepełnym strumieniem lub za szybko, lub też śmietanka nie ma oczekiwanego smaku, należy zmienić ustawienie stopnia mielenia – patrz „Ustawianie stopnia mielenia”, strona 241

 Jeżeli migają symbole  i  oznacza to, że kawa jest zbyt drobno zmielona. Należy zmienić ustawienia miאלkości kawy, patrz „Ustawianie stopnia mielenia”, strona 241.

 Jeżeli świeci się symbol , należy napełnić pojemnik na wodę, aby automat mógł przyrządzić kawę. (Normalną sytuacją jest, że symbol ten pojawia się, gdy w pojemniku znajduje się jeszcze niewielka ilość wody.)

 Jeżeli świeci się symbol , pojemnik na fusy jest pełen i należy go opróżnić i wyczyścić, patrz „Opróżnianie pojemnika na fusy”, strona 243. Dopóki pojemnik nie zostanie wyczyszczony symbol będzie się świecił, a automat nie będzie mógł przyrządzić kolejnego naparu kawy.

 Podczas nalewania kawy nie wolno wyjmować pojemnika na wodę. Jeżeli zostanie on wyjęty, automat nie może dalej przyrządzać kawy. W celu odpowietrzenia automatu do kawy należy obrócić pokrętko pary i gorącej wody maksymalnie w kierunku przeciwnym do ruchu wskazówek zegara na pozycję , aby woda wypływała z dyszy pary przez kilka sekund.

 Przy pierwszym uruchomieniu urządzenia zadowalający rezultat wystąpi po przyrządzeniu przynajmniej 4-5 kaw.



## 6.1 Co zrobić, aby kawa była bardziej gorąca:

- Aby przyrządzić małą filiżankę (poniżej 60 ml) kawy zaraz po włączeniu automatu, do podgrzania filiżanek należy wykorzystać gorącą wodę z płukania.
- W odpowiednim menu należy nastawić wyższą temperaturę kawy – patrz „Ustawianie temperatury kawy”, strona 242.
- Nie używać zbyt grubych, niepodgrzanych filiżanek, ponieważ pochłaniają one dużo ciepła.
- Podgrzewać filiżanki, płuczając je ciepłą wodą lub stawiając je na co najmniej 20 minut na ogrzewaną podstawkę na filiżanki (H) włączonego automatu do kawy.

PL

## 7 Przygotowywanie większej ilości filiżanek za pomocą funkcji dzbanka

Za pomocą tej funkcji można automatycznie przygotować **większą ilość filiżanek bezpośrednio do dzbanka ze stali szlachetnej, który podtrzymuje ciepło**: Mielenie, porcjowanie, ugniatanie, wstępne zaparzenie, zaparzenie i wyrzucanie zużytych fusów kawy odbywa się tak samo, jak opisano w poprzednim rozdziale.

-  Odchylić pokrywkę dzbanka stalowego w pozycję zdejmowania (rys. 16) i zdjąć pokrywkę. Wypluć dzbanek i pokrywkę.
-  Położyć pokrywkę w pozycji wylewania (rys. 17) na dzbanku i podstawić go pod wylot kawy (D). Wylot kawy musi być przesunięty całkowicie do góry, aby można było wsunąć dzbanek.

W zależności od wybranej ilości filiżanek podczas ostatniego użycia funkcji dzbanka świeci się jeden z symboli funkcji dzbanka. Ponadto świecą się symbole przeglądania menu „<” i „>”.



Liczba filiżanek kawy nalewanej do dzbanka wskazywana jest w następujący sposób:



-  4 filiżanki
-  6 filiżanek
-  8 filiżanek
-  10 filiżanek

-  Sprawdzić, czy pojemnik na wodę jest pełny, czy w pojemniku na ziarna jest dość kawy, a pojemnik na fusy jest pusty, aby móc przygotować serię kaw.

-  Aby zmienić moc oraz ilość nalewanej kawy, należy użyć pokrętła „Wielkość filiżanki” (rys. 12) lub „Moc naparu kawy” (rys. 13) zgodnie z

opisem w rozdz. „Przygotowywanie naparu z kawy ziarnistej”, strona 236.

-  W razie potrzeby za pomocą przycisków przeglądania „<” lub „>” wybrać symbol odpowiednio do liczby filiżanek kawy, która ma zostać przygotowana i nalana do dzbanka, np.  8 filiżanek.



-  Nacisnąć przycisk „Dzbanek”  (rys. 18).

Podczas przygotowywania naparu kawy miga symbol dzbanka odpowiednio do wybranej liczby filiżanek.

Po zakończeniu zaparzenia na zmianę migają wszystkie symbole dzbanka, przy czym symbol wybranej liczby filiżanek świeci się dwa razy dłużej niż pozostałe symbole.

-  Należy teraz wyjąć dzbanek i zamknąć pokrywkę (rys. 19), aby kawa była ciepła przez jak najdłuższy czas. Urządzenie powraca automatycznie do trybu przygotowywania kawy.





-  Jeżeli ilość ziaren kawy jest zbyt mała lub ilość wody w pojemniku nie wystarcza na dokończenie żądanej funkcji, lub też pojemnik na fusy jest pełny, to urządzenie przerywa aktualną operację i bieżący program zostaje przerwany. Po usunięciu przyczyny zakłócenia program wymaga ponownego uruchomienia. Należy przy tym uwzględnić ilość kawy, która jest już w dzbanku, aby dzbanek nie został przepełniony.

-  Jeżeli migają symbole  i  oznacza to, że kawa jest zbyt drobno zmielona. Należy zmienić ustawienia mialkości kawy, patrz „Ustawianie stopnia mielenia”, strona 241.



## 8 Przygotowywanie naparu z kawy sypkiej

Korzystając z tej funkcji można przygotować napar z kawy już zmielonej, na przykład z kawy pozbawionej kofeiny.

 Uwaga! Należy upewnić się, czy w pojemniku na kawę sybką nie zostały resztki kawy z poprzedniego parzenia i czy nie dostały się tam żadne ciała obce. Otwór na kawę sybką nie jest przeznaczony do przechowywania zapasu kawy; kawa z tego otworu musi dostać się bezpośrednio do komory zaparzania.

 Obrócić pokrętkę „Moc kawy / kawa mielona” (rys. 20) w żadaną pozycję  (1 filiżanka) lub  (2 filiżanki), aby wybrać funkcję z użyciem kawy sypkiej, mielonej. Wtedy młynek jest wyłączony. Świeci się symbol  (1 filiżanka) lub obydwa symbole  (2 filiżanki).

 Otworzyć pokrywę otworu kawy sypkiej i nasypać świeżo zmielonej kawy (rys. 21).

Używać do tego celu miarki dostarczonej wraz z urządzeniem. Nie wsypywać nigdy więcej niż 2 płaskie miarki kawy, ponieważ w przeciwnym razie urządzenie nie przyrządzi kawy, albo zmielona kawa zostanie rozsypana po urządzeniu i zanieczyści go, lub też kawa będzie nalewana kroplami i będą migaly symbole  i .



Nie wsypywać zmielonej kawy podczas parzenia. Kawę sybką do zaparzenia następnej filiżanki wsypać dopiero po zakończeniu zaparzania poprzedniej, gdy urządzenie jest ponownie gotowe. Nie wsypywać zmielonej kawy do wyłączonego urządzenia, ponieważ wtedy zostanie ona rozsypana w jego wnętrzu.

 Używać wyłącznie kawy mielonej przeznaczonej do parzenia w automatach Espresso. Otwór ten nie jest przeznaczony na kawę ziarnistą, rozpuszczalną, zamrożoną lub wysuszone produkty typu instant ani inne proszki do przygotowywania napojów. Zbyt miękko zmielona kawa może spowodować zapchanie urządzenia.







 W razie zapchania otworu wysypowego (wskutek obecności wilgoci w urządzeniu lub dlatego, że wysypano więcej niż 2 miarki zmielonej kawy) należy go przepchać za pomocą noża lub uchwyty łyżeczki (rys. 22). Następnie wyjąć zaparzac i wyczyścić go razem z automatem w sposób opisany w p. „Czyszczenie komory zaparzania”, strona 244.

 Zamknąć pokrywę.

 Wybrać żadaną wielkość filiżanki za pomocą pokrętki „Wielkość filiżanki” (rys. 12), zgodnie z opisem w rozdz. „Przygotowywanie naparu z kawy ziarnistej”, strona 236.

 Nacisnąć przycisk „1 filiżanka kawy” , aby przyrządzić 1 filiżankę, lub „2 filiżanki” , aby przyrządzić 2 filiżanki.

Rozpoczyna się proces przygotowania kawy.

 Jeżeli wybrana została funkcja zaparzania kawy sypkiej dla 1 filiżanki, a w otworze na kawę sybką nie ma kawy, to po wciśnięciu przycisku  migają symbole  i . Jeżeli wybrana została funkcja zaparzania kawy sypkiej dla 2 filiżanek, a w otworze na kawę sybką nie ma kawy, to po wciśnięciu przycisku  migają symbole  i .

 Aby po przyrządzeniu kawy ponownie powrócić do trybu pracy z użyciem kawy ziarnistej, należy obrócić pokrętkę „Moc kawy / kawa mielona” (rys. 20) na dowolne ustawienie (praca młynka będzie znowu możliwa).

## 9 Spienianie mleka

Wytworzoną parę można zastosować do spieniania mleka i do podgrzewania płynów. Ponieważ do wytworzenia pary potrzebna jest wyższa temperatura niż do zaparzania kawy, urządzenie ma tryb wytwarzania pary.

PL

- i** Aby otrzymać jedną porcję kawy cappuccino, należy wypełnić większą filiżankę do 1/2 lub 2/3 kawą espresso i dodać spienione mleko.
- !** Uwaga! Niebezpieczeństwo poparzenia podczas wypływu pary! Wypływająca gorąca woda, względnie gorąca para wodna, może spowodować poparzenie. Dlatego dyszę wypływu pary należy włączyć dopiero wtedy, gdy jest całkowicie zanurzona w mleku.
- ☞** Aby wytworzyć parę, nacisnąć przycisk „Para”  (rys. 23). Świeci się symbol  i trwa proces podgrzewania. Podczas podgrzewania miga symbol . Po zakończeniu podgrzewania symbol  świeci się w sposób ciągły. Urządzenie jest gotowe do spieniania mleka.
- i** Jeśli funkcja wytwarzania pary nie jest używana dłużej niż 2 minuty, urządzenie przełącza się automatycznie w tryb przygotowywania kawy.
- i** Aby uniknąć zmieszania pozostałości wody z mlekiem podczas spieniania, należy wcześniej spuścić wodę. W tym celu należy umieścić naczynie pod dyszą wylotu pary i obracać pokrętko pary i gorącej wody (rys. 10) odpowiednio długo w położenie , aż do ustawienia się pary. Następnie obrócić przełącznik obrotowy z powrotem w położenie .
- ☞** Nalać chude, zimne mleko do kubeczka pasującego do wstawienia pod dyszę wylotu pary.
- i** Mleko powinno być dobrze schłodzone. Również kubeczek na mleko powinien być chłodny, najlepiej stalowy, nie płukany uprzednio w ciepłej wodzie.
- ☞** Odchylić dyszę wylotu pary na zewnątrz i trzymać kubeczek pod nią tak, że otwór dyszy jest lekko zanurzony w mleku (rys. 24).
- !** **Uwaga!** Niebezpieczeństwo zanieczyszczenia dyszy wylotu pary przez zaschnięte mleko. Należy zwracać uwagę na to, aby dyszy wylotu pary nie zanurzać zbyt głęboko w mleku. Otwór wlotu powietrza w górnej części dyszy nie może być przykryty mlekiem. W przeciwnym razie mleko może być zassane do dyszy i spowodować jej zanieczyszczenie.
- ☞** Obrócić pokrętko pary i gorącej wody (rys. 10) na pozycję . Rozpocznie się spienianie mleka.
- i** Aby pianka mleka była bardziej kremowa, należy poruszać naczyniem powoli z dołu do góry. Spienianie należy kontynuować co najmniej tak długo, aż mleko podwoi swoją objętość.
- i** Zaleca się, aby nie nagrzewać pary przez dłużej niż 2 minuty bez przerwy.
- ☞** Aby zakończyć spienianie, obrócić pokrętko pary i gorącej wody (rys. 10) do pozycji  i następnie wyjąć naczynie.
- !** **Uwaga!** Niebezpieczeństwo poparzenia przez pryskające, gorące mleko! Wypływ pary należy wyłączyć, zanim odstawi się spod niego kubeczek ze spienionym mlekiem.
- ☞** Aby zakończyć tryb przygotowywania pary, nacisnąć przycisk „Para” (rys. 23) lub poczekać około 120 sekund, aż urządzenie przełączy się automatycznie w tryb przygotowywania kawy. Teraz urządzenie jest znowu gotowe do przygotowywania kawy.
- ☞** W każdym przypadku po zakończeniu spieniania należy jeszcze raz krótko wypuścić trochę gorącej wody z dyszy, obracając pokrętko pary i gorącej wody (rys. 10) na pozycję . Ta czynność jest niezbędna, aby zapobiec zaschnięciu resztek mleka w dyszy i zapchaniu jej. Należy użyć w tym celu odpowiedniego naczynia. Podczas tego procesu świeci się symbol .



- Następnie należy ponownie obrócić pokrętkę na pozycję ●, na wyświetlaczu pojawi się ostatnio wybrane ustawienie.

### 9.1 Czyszczenie dyszy

**Ważne:** Ze względu na higienę zaleca się, aby opisane poniżej czynności powtarzać za każdym razem po spienieniu mleka. W ten sposób można zapobiec osadzeniu się mleka we wnętrzu dyszy.

- Obrócić pokrętkę pary i gorącej wody w kierunku zgodnym z ruchem wskazówek zegara do oporu na pozycję ●. Poczekać kilka minut, aż dysza ostygnie.
- Następnie chwycić rurkę obrotową za czarny uchwyt i otworzyć zamknięcie bagnetowe dyszy, obracając delikatnie w kierunku zgodnym z ruchem wskazówek zegara. Ściągnąć dyszę w dół (rys. 25).
- Ściągnąć wewnętrzną część dyszy w dół z rurki.
- Wymyć dyszę i wewnętrzną część ciepłą wodą.
- Sprawdzić, czy dwa otwory zaznaczone na rys. 26 nie są zatkane. W razie potrzeby należy je przetkać igłą i oczyścić.
- Zamontować ponownie wewnętrzną część, nasuwając ją ostrożnie na rurkę.
- Zamontować ponownie dyszę, nasuwając i obracając ją w kierunku przeciwnym do ruchu wskazówek zegara.

## 10 Przygotowywanie gorącej wody

Gorącą wodę można używać do podgrzewania filiżanek i do przygotowywania gorących napojów, np. herbaty lub gotowych zup w proszku.

- ⚠ Uwaga! Niebezpieczeństwo poparzenia podczas wypływu gorącej wody! Wypływająca gorąca woda może spowodować poparzenie. Przed włą-

zeniem wypływu gorącej wody należy pod otworem wypływu ustawić odpowiednie naczynie.

- Ustawić naczynie pod otworem wypływu gorącej wody.
- Obrócić pokrętkę pary i gorącej wody na pozycję ☺☺☺ (rys. 10). Rozpocznie się przygotowywanie gorącej wody; pojawi się symbol ☺☺☺.
- ⓘ Zaleca się, aby nie nagrzewać gorącej wody przez dłużej niż 2 minuty bez przerwy.
- Po pobraniu gorącej wody obrócić pokrętkę pary i gorącej wody z powrotem na pozycję ● (rys. 10) i wyjąć naczynie.

## 11 Ustawianie stopnia mielenia

Fabrycznie młynek jest ustawiony na średni stopień grubość mielenia. Jeżeli kawa jest podawana za szybko lub za wolno (kroplami), to podczas mielenia można zmienić stopień miakości.

- ⚠ **Stopień mielenia można zmieniać tylko podczas procesu mielenia, tzn. pokrętkę ustawiania stopnia mielenia (rys. 2, T i rys. 27) obracać tylko, gdy pracuje młynek podczas przyrządzania kawy. Regulacja przy zatrzymanym młynku może spowodować uszkodzenie automatu do kawy.**

- Stopień mielenia ustawia się za pomocą pokrętki (rys. 2, T) (rys. 27).
  - Jeżeli kawa wypływa kroplami lub niecałkowicie (mogą przy tym migać symbole ☺ i ☺), należy wykonać jeden obrót pokrętkiem w kierunku zgodnym z ruchem wskazówek zegara. Obracać po jednej pozycji aż do uzyskania zadowalającej intensywności nalewania kawy.
  - Jeżeli kawa wycieka zbyt szybko lub jej smak nie spełnia oczekiwań, należy obrócić pokrętkę o jedną

PL

pozycję w kierunku przeciwnym do ruchu wskazówek zegara.

**i** Nie należy za daleko obracać pokrętki do regulacji stopnia mielenia, ponieważ przy 2 filiżankach kawa mogłaby wypływać kroplami.

**i** Skuteczność tych korekt można jednak zauważyć dopiero po co najmniej 2 kolejnych operacjach przyrządzania kawy.





#### **Usuwanie obcych ciał z młynka**

Dostanie się obcych ciał do młynka, np. kamyków, może spowodować jego uszkodzenie. Obce ciała w kawie powodują równomierne, głośne trzaskanie. Jeżeli podczas mielenia słychać taki dźwięk, należy natychmiast wyłączyć urządzenie i zwrócić się do serwisu.

**Zablokowanie lub uszkodzenie młynka przez ciała obce nie jest objęte gwarancją.**

## 12 Ustawianie temperatury kawy



Urządzenie ma trzy stopnie wyboru temperatury kawy. Fabrycznie ustawiona jest „Temperatura wysoka”. Można ją zmienić w następujący sposób:

**☞** Nacisnąć przycisk „P” (rys. 4). Nacisnąć przy włączonym urządzeniu przycisk „P” (rys. 4). Świecą się symbole „P” i . Ponadto świecą się 3 małe symbole nad filiżankami ,  i , które wskazują bieżącą funkcję filiżanek, patrz „Tryb specjalny”, strona 233.

**☞** Naciskać przyciski przeglądania menu „<” lub „>” (rys. 5) tak często, aż pojawi się symbol .

**☞** Wybrać ten punkt menu, naciskając przycisk „OK” (rys. 5).

Wyświetlacz wskazuje bieżące ustawienie przyrządzania kawy. Temperatura jest wskazywana w następujący sposób:

 Temperatura niska  
 Temperatura średnia  
 Temperatura wysoka

**☞** W razie potrzeby przyciskami przeglądania menu „<” lub „>” (rys. 5) wybrać inną temperaturę.

**☞** Po pojawieniu się żądanej temperatury potwierdzić wybór, naciskając przycisk „OK” (rys. 5). Ta temperatura zostanie zaprogramowana.

**i** Aby przerwać bez zapisywania ustawień, należy nacisnąć przycisk „P” zamiast „OK”.

**i** Jeżeli przycisk „OK” nie zostanie wciśnięty, urządzenie po ok. 120 sekundach automatycznie powróci do trybu przygotowania kawy bez zapisywania wprowadzonych ustawień.

**☞** Aby powrócić do trybu przygotowywania kawy, należy nacisnąć przycisk „P” (rys. 4) lub odczekać około 120 sekund, aż urządzenie przełączy się automatycznie w ten tryb.

## 13 Czyszczenie i konserwacja

Urządzenie powinno być stale utrzymywane w czystości, aby zapewnić stałą jakość kawy i sprawne funkcjonowanie.

### 13.1 Regularne czyszczenie

**!** **Uwaga!** Przed przystąpieniem do czyszczenia urządzenie należy wyłączyć. Następnie odczekać, aż ostygnie.

**!** **Uwaga!** Nigdy nie wkładać całego urządzenia lub jego części do zmywarki do naczyń. Automatu do kawy nie wolno zanurzać w wodzie.

**!** **Uwaga!** Nie wlewać wody do pojemnika na kawę ziarnistą, ponieważ spowoduje to uszkodzenie młynka.

**!** Nie używać szorujących, trących ani żrących środków do czyszczenia. Zewnętrzną i wewnętrzną część obudowy przecierać wilgotną ściereczką.

- ☞ Codziennie wyjmować pojemnik na wodę (rys. 6) i wylewać resztkę wody. Zbiornik na wodę płukać świeżą wodą. Codziennie nalewać świeżą wodę.
- ☞ Pojemnik na fusy należy opróżniać codziennie, a najpóźniej po pojawieniu się polecenia na wyświetlaczu – patrz „Opróżnianie pojemnika na fusy”, strona 243.
- ☞ Regularnie opróżniać podstawkę ociekową. Jednak nie później, niż gdy czerwony pływak podstawki ociekowej (rys. 28) pojawi się w otworze kratki ociekowej.
- ☞ Regularnie – co najmniej raz w tygodniu – czyścić pojemnik na wodę (N), podstawkę ociekową (O), kratkę ociekową (A) i pojemnik na fusy (Q), używając do tego celu ciepłej wody, łagodnego środka do mycia naczyń i ewentualnie pędzla.
- ☞ Po każdym spienieniu zdjąć dyszę i dokładnie oczyścić ją z resztek mleka – patrz „Czyszczenie dyszy”, strona 241.
- ☞ Sprawdzić, czy otwory w wylocie na kawę nie są zatkane. Podczas czyszczenia zaschniętą kawę można usunąć igłą (rys. 29).

### 13.2 Opróżnianie pojemnika na fusy

Urządzenie liczy ilość przygotowanych kaw. Po przyrządzeniu 14 pojedynczych filiżanek (lub 7 par) kawy pojawia się symbol ☒, informujący o tym, że pojemnik jest pełny i wymaga opróżnienia i wyczyszczenia. D czasu wyczyszczenia pojemnika na fusy automat nie może przyrządzać kawy.

- ☞ W celu wyczyszczenia pojemnika należy odblokować i otworzyć drzwiczki serwisowe, naciskając na odpowiedni przycisk (rys. 30), pojawi się symbol ☒.
- ☞ Wyjąć, opróżnić i wyczyścić podstawkę ociekową (rys. 31).
- ☞ Opróżnić i dokładnie wyczyścić pojemnik na fusy. Usunąć dokładnie

wszystkie resztki, które osadziły się na dnie.

**Ważne:** Za każdym razem, gdy wyjmowana jest podstawka ociekowa opróżniony, **musi** zostać też pojemnik na fusy – nawet, gdy nie jest jeszcze pełny. Jeżeli czynność ta nie zostanie wykonana, to przy następnych kawach może się zdarzyć, że zostanie on nadmiernie napełniony, a nadmiar fusów zatka urządzenie.

- i** Po wyjęciu podstawki ociekowej miga symbol ☒.
- i** Przy codziennym używaniu urządzenia pojemnik należy w zasadzie opróżniać codziennie. Pojemnik na fusy należy opróżniać przy włączonym urządzeniu. W przeciwnym razie urządzenie „nie pamięta” opróżnienia.

### 13.3 Czyszczenie młynka

Resztki zmielonej kawy można usunąć z pojemnika na ziarna kawowe za pomocą miękkiego pędzla lub odkurzacza.

- !** Uwaga! Nie wlewać wody do młynka, bo spowoduje to jego uszkodzenie.
- ☞ Wyłączyć urządzenie za pomocą przycisku Wł./Wył. (rys. 11) i wyłączyć głównego (rys. 8). Wyciągnąć wtyczkę z gniazdka sieciowego.
- ☞ Usunąć pozostałości ziaren kawy (np. przy pomocy odkurzacza z rurą lub z końcówką szczelinową).
- i** Jeżeli nie można usunąć obcego przedmiotu, należy skontaktować się z serwisem. Zablokowanie lub uszkodzenie młynka przez ciała obce nie jest objęte gwarancją.
- !** **Uwaga!** Niebezpieczeństwo obrażenia przy obracającym się młynku. Nigdy nie włączać urządzenia przy pracach z młynkiem. Może to spowodować bardzo poważne obrażenia. Wyciągnąć wtyczkę z gniazdka sieciowego.

PL

- ☞ Sprawdzić z małą ilością ziaren kawy działanie młynka, przygotowując jedną kawę. Przy pierwszym mieleniu lub także po czyszczeniu, do komory zaparzania dostaje się mniej zmielonej kawy, gdyż kanał musi zostać wypełniony. Może to mieć wpływ na jakość pierwszej kawy.

### 13.4 Czyszczenie komory zaparzania

Zalecane jest regularne czyszczenie zaparzacza (w zależności od intensywności użytkowania). Przed dłuższymi okresami nieużywania urządzenia (np. przed urlopem) konieczne jest opróżnienie pojemnika na fusy, pojemnika na wodę i dokładne oczyszczenie całości, w tym również komory zaparzania.

Postępowanie:

- ☞ Naciskając przycisk Wł./Wyl. (rys. 11) wyłączyć automat (nie wyciągać wtyczki z gniazdka) i poczekać, aż zgasną wszystkie symbole!
- ☞ Odblokować i otworzyć drzwiczki serwisowe, naciskając na odpowiedni przycisk (rys. 30).
- ☞ Wyjąć i wyczyścić podstawkę ociekową i pojemnik na fusy (rys. 31).
- ☞ Docisnąć z boku i do środka dwa czerwone przyciski odblokowujące zaparzacza (rys. 32), a następnie wyciągnąć zaparzacza.
- i** **Uwaga: Wyjęcie zaparzacza jest możliwe tylko wtedy, gdy urządzenie jest wyłączone przyciskiem Wł./Wyl. ① znajdującym się w przedniej części urządzenia. Nie należy odłączać urządzenia od sieci zasilającej. W razie prób wyjęcia zaparzacza przy włączonym urządzeniu może ulec ono poważnemu uszkodzeniu.**
- ☞ Zaparzacza myć bez używania żadnych środków myjących pod bieżącą wodą sieciową. **Nie wolno myć zaparzacza w zmywarkach do naczyń.**
- ☞ Dokładnie wyczyścić wnętrze automatu do kawy. Zbrylone resztki kawy wewnątrz urządzenia zdrapać drewnianym lub plastikowym widelcem lub innym podobnym przedmiotem, który nie powoduje zadrapań na powierzchni (rys. 33), a następnie wszystkie resztki usunąć odkurzaczem (rys. 34).
- ☞ Przy wkładaniu zaparzacza (rys. 36, a) włożyć do uchwytu (rys. 36, b) i wsunąć trzpień (rys. 36, c). Trzpień musi być wprowadzony do rurki (rys. 36, d) na dole przy zaparzaczu.
- ☞ Następnie nacisnąć mocno na PUSH (rys. 36, e), aż rozlegnie się dźwięk zatrzaśnięcia.
- ☞ Po usłyszeniu odgłosu zatrzaśnięcia sprawdzić, czy czerwone przyciski (rys. 36, f) są wysunięte. W przeciwnym razie nie można zamknąć drzwiczek serwisowych.

Rys. 37: Oba czerwone przyciski są prawidłowo wysunięte.

Rys. 38: Oba czerwone przyciski nie są prawidłowo wysunięte.

- ☞ Włożyć podstawkę ociekową razem z pojemnikiem na fusy.
- ☞ Zamknąć drzwiczki serwisowe.

**i** Jeżeli zaparzacza nie został prawidłowo włożony, tzn. bez charakterystycznego trzasku, a czerwone przyciski nie są wysunięte, zamknięcie drzwiczek serwisowych nie jest możliwe.

**i** Jeżeli występują trudności przy wkładaniu zaparzacza, to przed włożeniem należy go ustawić na odpowiednią wysokość, ściskając go jednocześnie od dołu i od góry, jak na rys. 35.

**i** Jeżeli nadal trudno jest włożyć zaparzacza, należy zamknąć drzwiczki serwisowe, wyciągnąć a następnie ponownie włączyć do gniazdka wtyczkę kabla zasilającego.

Poczekaj, aż zgasną wszystkie symbole, a następnie otworzyć drzwiczki serwisowe i włożyć zaparzacza.





### 13.5 Wykonywanie programu usuwania kamienia



Program usuwania kamienia umożliwia łatwe i skuteczne oczyszczenie urządzenia z osadów kamienia. Jeżeli symbol  wskazuje na konieczność odkamienienia urządzenia, należy je wykonać.



**Uwaga:** Nie wolno stosować odkamieniaczy, które nie są zalecane przez firmę AEG/Electrolux. W razie stosowania innych odkamieniaczy firma AEG/Electrolux nie odpowiada za ewentualne szkody. Odkamieniacz w płynie można nabyć u sprzedawcy automatów do kawy lub po kontakcie z linią serwisową AEG/Electrolux.

**i** Proces usuwania kamienia trwa około 45 minut i nie powinien być przerywany. Na skutek przerywania lub chwilowego braku prądu program trzeba uruchomić ponownie.

 Przed wykonaniem programu odkamieniania należy oczyścić zaparzacz (patrz „Czyszczenie komory zaparzania”, strona 244).

 Nacisnąć przycisk „P” (rys. 4).  
Nacisnąć przy włączonym urządzeniu przycisk „P” (rys. 4). Świecą się symbole „P” i . Ponadto świecą się 3 małe symbole nad filiżankami ,  i , które wskazują bieżącą funkcję filiżanek, patrz „Tryb specjalny”, strona 233.

 Naciskać przyciski przeglądania menu „<” lub „>” (rys. 5) tak często, aż pojawi się symbol .

 Potwierdzić, naciskając przycisk „OK” (rys. 5). Symbole  i  migają, a „P” świeci się w sposób ciągły.



**i** Aby przerwać program odkamieniania w tym miejscu, należy wyłączyć urządzenie za pomocą przycisku „Wi./Wył”  (rys. 11).



 Opróżnić pojemnik na wodę, włączyć do niego co najmniej litr wody i dodać odkamieniacz.



**!** Uwaga: Ewentualne odpryski odkamieniacza nie mogą spaść na powierzchnie wrażliwe na działanie kwasów, np. marmur, wapień i ceramika.

 Pod dyszę parową podstawić naczynie o pojemności co najmniej 1,5 litra (rys. 9).

 Ustawić pokrętkę pary i gorącej wody w pozycji  .

Rozpocznie się program usuwania kamienia, a płynny odkamieniacz będzie wypływał z dyszy. Symbole ,  i „P” świecą się w sposób ciągły. Program usuwania kamienia automatycznie wykona serię płukań z przerwami, których celem jest usunięcie osadów kamienia z wnętrza automatu do kawy.

Po upływie ok. 30 minut pojemnik na wodę jest pusty i migają symbole  i , a „P” świeci się w sposób ciągły.



 Ustawić pokrętkę pary i gorącej wody z powrotem w pozycji .



Teraz urządzenie jest gotowe do płukania świeżą wodą.



 Wyjąć pojemnik na wodę, włączyć do niego świeżej wody i włożyć go na swoje miejsce.

 Opróżnić naczynie pod dyszą i wstawić ją w to samo miejsce.

 Ustawić pokrętkę pary i gorącej wody w pozycji  .

Zostanie przeprowadzone płukanie świeżą wodą, a z dyszy wypłynie woda użyta do tego płukania. Symbole ,  i „P” świecą się w sposób ciągły.

Po upływie kilku minut pojemnik na wodę jest pusty i migają symbole  i , a „P” świeci się w sposób ciągły.

 Ustawić pokrętkę pary i gorącej wody z powrotem w pozycji .

Pojawiają się symbole odpowiednio do ostatnio wybranego trybu przygotowywania kawy, a symbol  świeci się w sposób ciągły.

 Opróżnić naczynie z wodą z płukania.

PL

- ☞ Wyjąć pojemnik na wodę, włączyć do niego świeżej wody i włożyć go na swoje miejsce.

Urządzenie jest teraz ponownie gotowe do pracy i jest w stanie ostatnio wybranego trybu przygotowywania kawy.

- i Po wykonaniu programu odkamieniania zalecane jest wylanie pierwszej zaparzonej filiżanki kawy.

## 14 Zamawianie wyposażenia dodatkowego

Aby urządzenie służyło jak najdłużej i aby uniknąć przedwczesnych uszkodzeń, należy je regularnie czyścić i odkamieniać. Oryginalny odkamieniacz mogą Państwo zakupić również bezpośrednio w naszej firmie.

Mieszkając w Niemczech, można dzwonić na specjalny numer „gorącej linii” zamówień

1801 - 20 30 60\*

(\*wg stawek jak za rozmowy lokalne z sieci stacjonarnej Deutsche Telekom) od poniedziałku do piątku w godz. 8.00 - 18.00.

## 15 Co zrobić, jeżeli na wyświetlaczu pojawi się następujący komunikat...

### Symbol ☹️ świeci się w sposób ciągły

- Pojemnik na wodę jest pusty lub niewłożony prawidłowo.
- ☞ Napełnić i prawidłowo włożyć pojemnik – patrz „Napełnianie wodą”, strona 233.
- Pojemnik na wodę jest zabrudzony lub utworzyły się w nim bryłki kamienia.
- ☞ Wypłukać lub oczyścić pojemnik z kamienia.

### Migają symbole ☹️ i ⚠️

- Przyrządzenie kawy nie jest możliwe.
- ☞ Podstawić naczynie pod dyszę i obrócić pokrętką pary i gorącej

wody w kierunku przeciwnym do ruchu wskazówek zegara w pozycję ☹️☹️☹️ (rys. 9).

- Kawa wypływa zbyt powoli.
- ☞ Obrócić gałkę do regulacji stopnia mielenia (rys. 12) o jedną pozycję w kierunku zgodnym z ruchem wskazówek zegara, gdy młynek pracuje w czasie zaparzania kawy ziarnistej (patrz „Ustawianie stopnia mielenia”, strona 241).

### Symbol ☹️ świeci się w sposób ciągły

- Pojemnik na fusy jest pełny.
- ☞ Opróżnić i wyczyścić i włożyć pojemnik jak opisano w „Opróżnianie pojemnika na fusy”, strona 243.

### Miga symbol ☹️

- Po czyszczeniu pojemnik na fusy nie został z powrotem włożony do urządzenia.
- ☞ Otworzyć drzwiczki serwisowe i włożyć pojemnik na fusy.

### Migają symbole ☹️ lub ☹️ i ⚠️

- Po wybraniu tej funkcji do otworu nie wsypano zmielonej kawy.
- ☞ Wsypanie zmieloną kawę, jak opisano w p. „Przygotowywanie naparu z kawy sypkiej”, strona 238.

### Wszystkie symbole mocy naparu kawy ☹️☹️☹️☹️ i ⚠️ migają

- Pojemnik na kawę ziarnistą jest pusty.
- ☞ Napełnić pojemnik na kawę ziarnistą – patrz „Napełnianie pojemnika na kawę ziarnistą”, strona 233.
- Jeżeli młynek pracuje bardzo głośno, to może to oznaczać, że został on zablokowany kamyczkiem znajdującym się w między ziarnami kawy.
- ☞ W takiej sytuacji należy zwrócić się do serwisu. **Zablokowanie lub uszkodzenie młynka przez ciała obce nie jest objęte gwarancją.**



**Symbol  świeci się w sposób ciągły**

- Komunikat ten informuje, że w automacie do kawy znajdują się osady kamienia.
-  Należy jak najszybciej przeprowadzić program odkamieniania opisany w rozdziale „Wykonywanie programu usuwania kamienia”, strona 245.

**Symbol  świeci się w sposób ciągły**

- Drzwiczki serwisowe są otwarte.
-  Zamknąć drzwiczki. Jeżeli zamknięcie drzwiczek nie jest możliwe, należy sprawdzić, czy zaparacz jest prawidłowo włożony (patrz „Czyszczenie komory zaparzania”, strona 244).



**Miga symbol **

- Prawdopodobnie po czyszczeniu zapomniano włożyć zaparacz z powrotem do urządzenia.
-  Włożyć zaparacz – patrz „Czyszczenie komory zaparzania”, strona 244.
- Wnętrze urządzenia jest bardzo zanieczyszczone.
-  Dokładnie oczyścić wnętrze urządzenia – patrz punkt „Czyszczenie komory zaparzania”, strona 244. Jeżeli po wyczyszczeniu urządzenie nadal zgłasza ten komunikat, należy zwrócić się do serwisu.

**Symbol  świeci się w sposób ciągły**

- Oznacza to alarm ogólny.
-  W takiej sytuacji należy zwrócić się do serwisu.

**Migają symbole  i **

- Urządzenie zostało włączone z pokrętkiem do wytwarzania pary i gorącej wody w położeniu „otwartym” .
-  Obrócić pokrętko pary i gorącej wody w kierunku zgodnym z ruchem wskazówek zegara (rys. 10) do oporu do pozycji .

**Migają symbole  i **

- Temperatura otoczenia jest zbyt niska, aby korzystać z automatu.
-  Urządzenie należy eksploatować w cieplejszym pomieszczeniu.



## 16 Problemy, które można samodzielnie rozwiązać przed wezwaniem serwisu

Jeżeli automat do kawy nie działa, przyczynę awarii można łatwo znaleźć i usunąć, korzystając z porad zawartych w rozdziale „Co zrobić, jeżeli na wyświetlaczu pojawi się następujący komunikat...”, strona 246. Jeżeli urządzenie nie wyświetla żadnego symbolu, przed zgłoszeniem się do serwisu należy sprawdzić poniższą listę problemów.

**Kawa nie jest gorąca**

- Filiżanki nie zostały podgrzane.
-  Podgrzać filiżanki, płucząc je gorącą wodą lub stawiając na co najmniej 20 minut na ogrzewanej podstawce (H) (patrz „Co zrobić, aby kawa była bardziej gorąca:”, strona 237).

**Kawa ma mało pianki Crema**

- Za grubo zmielona kawa.
-  Obrócić gałką do regulacji stopnia mielenia o jedną pozycję w kierunku przeciwnym do ruchu wskazówek zegara, gdy młynek pracuje w czasie zaparzania naparu z kawy ziarnistej (patrz „Ustawianie stopnia mielenia”, strona 241).
- Niewłaściwa mieszanka kawy.
-  Zastosować mieszanki kawowe nadające się do stosowania w automatach.

**Kawa wypływa zbyt powoli**

- Kawa zmielona jest zbyt miękko.
-  Obrócić gałką do regulacji stopnia mielenia o jedną pozycję w kierunku zgodnym z ruchem wskazówek zegara, gdy młynek pracuje w czasie

PL

zaparzania naparu z kawy ziarnistej (patrz „Ustawianie stopnia mielenia”, strona 241).

#### **Kawa wypływa zbyt szybko**

- Za grubo zmielona kawa.
- ☞ Obrócić gałką do regulacji stopnia mielenia o jedną pozycję w kierunku przeciwnym do ruchu wskazówek zegara, gdy młynek pracuje w czasie zaparzania naparu z kawy ziarnistej (patrz „Ustawianie stopnia mielenia”, strona 241).

#### **Kawa wypływa tylko z jednego otworu wypływowego**

- Otwory wypływowe są zatkane.
- ☞ Usunąć zaschniętą kawę za pomocą igły (rys. 29).

#### **Mimo obracania pokręteł pary i gorącej wody z dyszy nie wydostaje się para**

- Zatkane są małe otworki w dyszy i wewnętrznej części dyszy.
- ☞ Wyczyścić otworki w dyszy i wewnętrznej części dyszy (patrz „Czyszczenie dyszy”, strona 241).

#### **Gdy wybrana jest funkcja ☞ lub ☞, z automatu nie płynie kawa, tylko woda**

- Zmielona kawa zawiesiła się w kanale wyspowym.
- ☞ Przepchać kanał wyspowy zatkany zmieloną kawą za pomocą noża (patrz „Przygotowywanie naparu z kawy sypkiej”, strona 238) (rys. 22). Następnie wyczyścić zaparzacze i wnętrze urządzenia (patrz „Czyszczenie komory zaparzania”, strona 244).

#### **Po naciśnięciu przycisku ① urządzenie nie włącza się**

- Nie jest włączony wyłącznik główny znajdujący się w tylnej części urządzenia (rys. 8) lub wtyczka nie została włożona do gniazdka.
- ☞ Sprawdzić, czy wyłącznik główny jest ustawiony w pozycji „I” i czy wtyczka jest prawidłowo włożona do gniazdka.

#### **Nie można wyjąć zaparzacza, aby go wyczyścić**

- Automat jest włączony. Zaparzacze można wyjąć tylko przy wyłączonym urządzeniu.
- ☞ Wyłączyć urządzenie i wyjąć zaparzacze (patrz „Czyszczenie komory zaparzania”, strona 244).

**i Uwaga: Wyjęcie zaparzacza jest możliwe tylko wtedy, gdy urządzenie jest wyłączone przyciskiem Wł./Wyl. ① znajdującym się w przedniej części urządzenia. Nie należy odłączać urządzenia od sieci zasilającej. W razie prób wyjęcia zaparzacza przy włączonym urządzeniu może ulec ono poważnemu uszkodzeniu.**

#### **Kawa nie wypływa z otworów wypływowych, tylko z boku przez drzwiczki serwisowe**

- Otwory wypływowe są zatkane zaschniętymi resztkami kawy.
- ☞ Usunąć zaschniętą kawę za pomocą igły (rys. 29).
- Półka obrotowa znajdująca się od wewnątrz na drzwiczkach serwisowych (R) jest zablokowana i nie przechyliła się.
- ☞ Oczyszczyć półkę, przede wszystkim w pobliżu zawiasów, aby były ruchome.

#### **Zastosowano kawę mieloną (zamiast ziarnistej) i dlatego maszyna nie produkuje kawy.**

- Wsypano za dużo zmielonej kawy.
- ☞ Wyjąć zaparzacze i dokładnie wyczyścić wnętrze urządzenia, jak opisano w p. „Czyszczenie komory zaparzania”, strona 244. Powtórzyć tę czynność, używając maks. 2 płaskie miarki mielonej kawy.
- Pokrętko „Moc kawy / kawa mielona” nie została ustawiona w pozycji ☞ lub ☞ i urządzenie używało zarówno wsypanej kawy mielonej, jak i samodzielnie zmielonej kawy ziarnistej.
- ☞ Wyczyścić dokładnie wnętrze urządzenia, jak opisano w p. „Czyszcze-



nie komory zaparzania”, strona 244. Powtórz tę czynność, ustawiając najpierw pokrętko „Moc kawy / kawa mielona” we właściwym pozycji, jak opisano w p. „Przygotowywanie naparu z kawy sypkiej”, strona 238.

- Zmielona kawa została wsypana do urządzenia, gdy było ono wyłączone.
-  Wyjąć zaparzacze i dokładnie wyczyścić wnętrze urządzenia, jak opisano w p. „Czyszczenie komory zaparzania”, strona 244. Powtórz tę czynność przy włączonym urządzeniu.

#### Przed transportem urządzenia

- Przechowywać oryginalne opakowanie w celu zabezpieczenia podczas transportu. W celu ochrony przed zadrapaniami stosować koniecznie folię oryginalną.
- Zabezpieczyć urządzenie i dzbanek przed uderzeniami. Producent nie odpowiada za szkody podczas transportu.
- Opróżnić pojemnik na wodę i pojemnik na fusy.
- Zwracać uwagę na odpowiednie miejsce przechowywania urządzenia, szczególnie w zimnych porach roku. W przeciwnym razie mogą powstać uszkodzenia spowodowane mrozem.



## 17 Tryb statystyki

Urządzenie umożliwia sprawdzenie następujących wartości:





- liczba wszystkich kaw przyrządzonych dotychczas przy pomocy tego urządzenia,
- liczba wszystkich przyrządzonych dzbanków z 4 filiżankami, 6 filiżankami, 8 filiżankami i 10 filiżankami,
- liczba wykonanych procesów odkamieniania, i ponadto
- liczba litrów wody zużytych przez maszynę.

-  Również gdy przygotowano jednorazowo 2 filiżanki, zostaną one policzone jako 2 filiżanki.

Aby włączyć tryb statystyki, urządzenie musi być wyłączone.

-  Jeżeli to konieczne, włączyć urządzenie za pomocą przycisku „Wł./Wyl”  (rys. 11).

-  Nacisnąć przycisk „P” (rys. 4) przynajmniej na 6 sekund.

Nacisnąć przy włączonym urządzeniu przycisk „P” (rys. 4). Świecą się symbole „P” i . Ponadto świecą się 3 małe symbole nad filiżankami ,  i , które wskazują bieżącą funkcję filiżanek, patrz „Tryb specjalny”, strona 233.

-  Naciskać przyciski przeglądania menu „<” lub „>” (rys. 5) tak często, aż pojawi się symbol, dla którego ma zostać wyświetlona statystyka.

 Liczba przyrządzonych kaw

 Liczba wykonanych procesów odkamieniania

 Liczba przyrządzonych dzbanków na 4 filiżanki kawy

 Liczba przyrządzonych dzbanków na 6 filiżanek kawy

 Liczba przyrządzonych dzbanków na 8 filiżanek kawy



 Liczba przyrządzonych dzbanków na 10 filiżanek kawy

 Liczba litrów wody zużytych przez maszynę



Gdy świeci się dany symbol, właściwą liczbę można wyświetlić w następujący sposób:

-  Nacisnąć przycisk „OK” i przytrzymać (rys. 5).

W kolejności zaczynają migać poszczególne wskazania, przy czym żądana liczba wskazywana jest w następujący sposób:





-  1 x mignięcie odpowiada 1
-  1 x mignięcie odpowiada 10
-  1 x mignięcie odpowiada 100

PL

-  1 x mignięcie  
odpowiada 1,000
-  1 x mignięcie  
odpowiada 10,000

Mignięcia powtarzają się na bieżąco tak długo, jak długo naciśnięty jest przycisk „OK”. Przed każdym powtórzeniem następuje przerwa trwająca 3 sekundy.

-  Należy policzyć liczbę poszczególnych mignięć.  
Przykład: następujący szereg mignięć odpowiada liczbie 1529.

-  9 x mignięć
-  2 x mignięć
-  5 x mignięć
-  1 x mignięć
-  0 x mignięć

-  Aby wyjść z trybu statystyki, nacisnąć przycisk „P” (rys. 4) przynajmniej na 6 sekund.

## 18 Dane techniczne

Napięcie znamionowe: 220-240 V  
Pobór mocy: 1350 W

 To urządzenie odpowiada następującym dyrektywom obowiązującym w Unii Europejskiej:

- 73/23/EWG z dnia 19.02.1973 „Dyrektywa w sprawie urządzeń niskonapięciowych”, włącznie z dyrektywą nowelizującą 93/68/EWG.
- 89/336/EWG z dnia 03.05.1989 „Dyrektywa w sprawie zgodności elektromagnetycznej”, włącznie z dyrektywą nowelizującą 92/31/EWG.

## 19 Utylizacja



### Opakowanie

Opakowanie wykonano z materiałów ekologicznych i nadających się do ponownego wykorzystania. Części wykonane z tworzyw sztucznych są oznakowane, np. >PE<, >PS< itd. Opakowania należy utylizować zgodnie z ich oznaczeniem w zakładach oczyszczania i przetwarzania odpadów miejskich, w pojemnikach służących do gromadzenia tego typu odpadów.



### Stare urządzenia

Symbol  na samym produkcie lub jego opakowaniu wskazuje, że stare urządzenie nie może być wyrzucone z normalnymi odpadami domowymi, lecz trzeba je utylizować w punktach zajmujących się recyklingiem urządzeń elektrycznych i elektronicznych. Stosując prawidłowe procedury utylizacji tego rodzaju urządzeń przyczyniamy się do ochrony środowiska i zdrowia współmieszkańców. Niewłaściwa utylizacja zagraża zdrowiu i środowisku. Więcej informacji dotyczących recyklingu tego produktu można otrzymać w urzędach gminnych, zakładach usług komunalnych i w miejscu zakupu.

## 20 W przypadku naprawy

Bezwzględnie zachować oryginalne opakowanie i elementy piankowe. Aby uniknąć uszkodzeń podczas transportu, urządzenie należy odpowiednio opakować.

Urządzenie przesyłać zawsze z dzbankiem. Jest on niezbędny do wykonania testu urządzenia.

**H Tisztelt Vásárló!**

Kérjük, figyelmesen olvassa el ezt a használati útmutatót.

Mindenekelőtt kérjük, tartsa be az útmutató első lapjain közölt biztonsági tudnivalókat. A használati útmutatót gondosan őrizze meg, hogy később is felhasználhassa. Ha a készüléket eladja vagy elajándékozza, kérjük, adja tovább az útmutatót is az új tulajdonosnak.

**Tartalomjegyzék**

<b>1</b>	<b>Jelmagyarázat</b>	<b>252</b>	<b>11</b>	<b>Az őrlési finomság beállítása</b>	<b>263</b>
1.1	Előlnézet (1. ábra)	252	<b>12</b>	<b>A kávéhőmérséklet beállítása</b>	<b>263</b>
1.2	Előlnézet nyitott karbantartónyílással (2. ábra)	252	<b>13</b>	<b>Tisztítás és ápolás</b>	<b>264</b>
1.3	Kezelőmező (3. ábra)	252	13.1	Rendszeres tisztítás	264
<b>2</b>	<b>Kávé és presszókávé</b>	<b>253</b>	13.2A	zacctartály kiürítése	264
<b>3</b>	<b>Biztonsági tudnivalók</b>	<b>253</b>	13.3A	daráló tisztítása	265
<b>4</b>	<b>Speciális üzemmód</b>	<b>255</b>	13.4A	forrázóegység tisztítása	265
<b>5</b>	<b>Az első üzembe helyezés</b>	<b>255</b>	13.5A	vízkömentesítő program végrehajtása	266
5.1	A készülék felállítása és csatlakoztatása	255	<b>14</b>	<b>Tartozékrendelés</b>	<b>267</b>
5.2	Víz betöltése	255	<b>15</b>	<b>Mi a teendő, ha a kijelzőn az alábbi üzenet jelenik meg?</b>	<b>267</b>
5.3	A babkávé tartályának feltöltése	255	<b>16</b>	<b>A vevőszolgálat nélkül megoldható problémák</b>	<b>268</b>
5.4	A készülék első bekapcsolása	256	<b>17</b>	<b>Statisztika üzemmód</b>	<b>270</b>
5.5	A készülék bekapcsolása	256	<b>18</b>	<b>Műszaki adatok</b>	<b>271</b>
5.6	A készülék kikapcsolása	256	<b>19</b>	<b>Ártalmatlanítás</b>	<b>272</b>
5.7	A vízkeménység beállítása	257	<b>20</b>	<b>Ha javításra van szükség</b>	<b>272</b>
<b>6</b>	<b>Kávékészítés babkávéból</b>	<b>258</b>			
6.1	Tanácsok forróbb kávé kiadásához	259			
<b>7</b>	<b>Több csésze kávé készítése a kanna funkcióval</b>	<b>259</b>			
<b>8</b>	<b>Kávékészítés őrölt kávéból</b>	<b>260</b>			
<b>9</b>	<b>Tejhabosítás</b>	<b>261</b>			
9.1	A gőzfúvóka megtisztítása	262			
<b>10</b>	<b>Forró víz készítése</b>	<b>262</b>			

H

## 1 Jelmagyarázat















### 1.1 Előlnézet (1. ábra)

- A** Csepegtetőrács
- B** Melegen tartó kanna
- C** Főkapcsoló (a készülék hátoldalán)
- D** Állítható magasságú kávékifolyó
- E** Kezelőmező (lásd 3. ábra)
- F** A babkávétartály fedele
- G** Az őrölt kávé rekeszének fedele
- H** Fűtött csészétároló
- J** A gőz és a forró víz forgatható csöve
- K** Gőzfűvóka (levehető)
- L** A gőzfűvóka belső része (levehető)
- M** A karbantartónyílás nyitó gombja
- N** Víztartály maximum-jelöléssel (kivehető)
- O** Cseptálca úszóval (kivehető)

### 1.2 Előlnézet nyitott karbantartónyílással (2. ábra)

- P** Karbantartónyílás (nyitva)
- Q** Zacctartály (kivehető)
- R** Mozgatható rekesz
- S** Forrázóegység
- T** Az őrlési finomság beállító gombja
- U** A babkávétartály
- V** Mérőkanál
- W** Az őrölt kávé betöltőrekesze
- X** Típustábla (a készülék alján)
- Y** Folyékony vízkömentesítő
- Z** Tesztcsík

### 1.3 Kezelőmező (3. ábra)

- a** „Kávéerősség / őrölt kávé” forgatható gomb
- b** „Csészeméret” forgatható gomb
- c** Kijelző
- d** 1 csésze kávé készítésére szolgáló  gomb  
Speciális üzemmódban ez a gomb „lapozásra” szolgál („<”)
- e** 2 csésze kávé készítésére szolgáló  gomb  
Speciális üzemmódban ez a gomb „lapozásra” szolgál („>”)
- f** „Gőz” gomb   
Speciális üzemmódban ez a gomb nyugtázza a menüpontot („OK”)
- g** „P” gomb  
Speciális üzemmódban ezzel a gombbal – módosítások végrehajtása nélkül – visszatérhetünk a legutóbbi szintre („P”)
- h** „KI/BE” gomb 
- j** A gőz és a forró víz forgatható gombja
- k** „Kanna: kávéerősség” gomb 
- l** „Őrölt kávé” szimbólumok
- m** „Kanna” szimbólumok
- n** „Kávéerősség” szimbólumok
- o** „Csészeméret” szimbólumok
- p** „Víztartály üres” szimbólum 
- q** „Vízkömentesítés” szimbólum 
- r** „Készülék hőmérséklet” szimbólum 
- s** „Karbantartónyílás nyitva” szimbólum 
- t** „Zacctartály” szimbólum 
- u** „Figyelem” szimbólum 
- v** „Forró víz” szimbólum 
- w** „Gőz” szimbólum 
- x** „2 csésze készítése” szimbólum 
- y** „1 csésze készítése” szimbólum 
- z** A speciális üzemmód szimbólumai

## 2 Kávé és presszókávé

A kávéautomata működése egyszerű **kezelhetőséget** biztosít a kávékészítés, valamint a karbantartás és a gondozás során is.

A kitűnő, egyéni **íz** az alábbiaknak köszönhető:

- előforrázó rendszer: a tulajdonképpeni forrázás előtt a készülék megnedvesíti az őrölt kávé, hogy kiaknázza a teljes aromát,
  - csészénként egyedileg beállítható vízmennyiség a kávéhabos rövid presszókávé és „hosszú” kávé között,
  - egyedileg beállítható forrázási kávéhőmérséklet,
  - választási lehetőség normál és erős kávé között,
  - a babkávé pörköléséhez állítható őrlési finomság,
  - és nem utolsósorban a garantált kávéhab, az a habkorona, ami a hozzáértők számára a presszókávé páratlaná teszi.
- Egyebekben: A víz az őrölt kávéval lényegesen rövidebb ideig érintkezik a presszókávé esetében, mint a hagyományos filteres kávénál. Ezáltal kevesebb keserű anyag oldódik ki a kávéból, ami sokkal kellemesebbé teszi a presszókávé!

## 3 Biztonsági tudnivalók



Ez a készülék biztonsági szempontból megfelel az elismert műszaki szabványoknak és a készülékbiztonságról szóló törvény előírásainak. Gyártóként mégis kötelességünknek érezzük, hogy felhívjuk a figyelmét az alábbi biztonsági tudnivalókra.

### Általános biztonság

- A készüléket kizárólag olyan elektromos hálózatra szabad csatlakoztatni, amelynek feszültsége, áramfajtája és frekvenciája megegyezik a típustáblán megadottakkal (lásd a készülék alján)!
- A tápvezeték sohasem érintkezzen a készülék forró részeivel.
- A hálózati csatlakozódugót sohasem a vezetéknél fogva húzza ki az aljzatból!
- Ne helyezze üzembe a készüléket, ha:
  - sérült a tápvezeték vagy
  - a házon látható sérülések vannak.
- A hálózati csatlakozódugót mindig a készülék kikapcsolt állapotában dugja be az aljzatba.
- Korlátozott fizikai, érzékszervi vagy szellemi képességű, ill. a készülék kezeléséhez szükséges tapasztalattal és ismeretekkel nem rendelkező személyek (beleértve a gyermekeket) a készüléket kizárólag csak az értük felelős személy által végzett betanítás és kezdeti felügyelet után üzemeltethetik és használhatják.

### A gyermekek biztonsága

- **Sohase működtesse a készüléket felügyelet nélkül, és gyermekek jelenlétében különösen körültekintően használja!**
- Csomagolóanyagok (pl. fóliazacskók) nem gyermekek kezébe valók.

(H)

**Biztonságos üzemeltetés**

- **Vigyázat! A kávékifolyó, a gőzfúvóka és a csészetároló működés közben üzemszerűen felforrósodik. A gyermekeket tartsa távol a készüléktől!**
- **Vigyázat! Bekapcsolt gőzfúvóka esetén forrázveszély áll fenn! A kilépő forró víz ill. forró vízgőz égési sérülést okozhat. A gőzfúvókát csak akkor kapcsolja be, amikor edényt tart a gőzfúvóka alá.**
- Gyúlékony folyadékot ne melegítsen gőzzel!
- A készüléket csak akkor üzemeltesse, ha van víz a rendszerben! A víz-tartályba kizárólag hideg vizet töltsön. **Ne töltsön bele forró vizet, tejet vagy más folyadékot.** Vegye figyelembe, hogy a max. feltöltési mennyiség kb. 1,8 liter.
- **Ne tegyen fagyasztott vagy karamellezett kávészemeket a kávé-tartályba, csak pörkölt babkávét! Az idegen testeket, pl. az apró kövecskéket távolítsa el a kávészemek közül. Ha a daráló megakad vagy megsérül egy idegen test miatt, az lehet, hogy nem esik a garancia hatálya alá.**
- Az őrölt kávé rekeszébe csak őrölt kávé-t tegyen.
- Ne hagyja szükségtelenül bekapcsoltva a készüléket.
- A készüléket ne tegye ki az időjárás hatásának.
- Hosszabbító kábel használata esetén kizárólag kereskedelemben kapható, legalább 1,5 mm<sup>2</sup> vezeték-keresztmetszetű kábelt használjon.
- A veszélyek elkerülése érdekében mozgászavarban szenvedő személyek soha ne használják a készüléket kísérszemély nélkül.
- **A készüléket csak akkor üzemeltesse, ha be van helyezve a csepptálca, a zacstartály és a csepegtetőrács!**

**Biztonság a tisztítás és gondozás során**

- Vegye figyelembe a tisztítási és vízkő-mentesítési tudnivalókat.
- A karbantartás ill. a tisztítás előtt a készüléket kapcsolja ki, és húzza ki a hálózati csatlakozódugót!
- Ne merítse víz alá a készüléket.
- A gőzfúvókát csak kikapcsolt, lehűlt és nyomásmentes állapotban tisztítsa!
- A készülék alkatrészeit ne tisztítsa mosogatógépben.
- **Sohase öntsön vizet a darálóba, a víz károsítja a darálót.**

A készüléket ne nyissa fel, és ne próbálja megjavítani. A szakszerűtlen javítás következtében a felhasználó súlyos veszélynek lehet kitéve.



Villamos készülékeken csak képzett szakember végezhet javítást.



Amennyiben esetleg javítás szükséges, beleértve a hálózati tápvezeték cseréjét is, kérjük forduljon

- ahhoz a szakkereskedőhöz, akinél a készüléket vásárolta, vagy
- az AEG/Electrolux szervizvoná-lá-hoz.

**A készülék nem rendeltetésszerű használata vagy helytelen kezelése esetén nem tudunk garanciát ill. felelősséget vállalni az esetleges károkért – ugyanez érvényes abban az esetben is, ha a tisztítási és a vízkőmentesítő programot nem ennek a használati útmutatónak megfelelően, vagy a  szimbólum megjelenése után nem azonnal hajtják végre. Ha a daráló megakad vagy megsérül egy idegen test miatt, az lehet, hogy nem esik a garancia hatálya alá.**

## 4 Speciális üzemmód

A vízkeménység („A vízkeménység beállítása”, 257. oldal) és a kávéhőmérséklet („A kávéhőmérséklet beállítása”, 263. oldal) beállításához, a vízkömentesítő program indításához („A vízkömentesítő program végrehajtása”, 266. oldal) és a statisztika megtekintéséhez („Statisztika üzemmód”, 270. oldal) a „P” gomb (4. ábra) megnyomásával kapcsolhatunk át speciális üzemmódba. Speciális üzemmódban az „1 csésze kávé” , „2 csésze kávé” , „gőz”  és „P” gomb a menüben való lépkedésre szolgál. A megfelelő funkció a kijelzőn a gomb felett látható (5. ábra):

- Az „<” („1 csésze kávé” ) és a „>” („2 csésze kávé” ) gombbal „lapozhatunk”.
- Az „OK” („gőz” ) gombbal nyugtázható az adott pont.
- A „P” („P”) gombbal visszatérhetünk a legutóbbi szintre, módosítás végrehajtása nélkül.

## 5 Az első üzembe helyezés

### 5.1 A készülék felállítása és csatlakoztatása

Válasszon ki egy megfelelő, vízszintes, stabil, fűtetlen, száraz és vízálló felületet.

-  Ügyeljen a jó levegőáramlásra. A készülék oldalán és hátulján legalább 5 cm, a készülék felett legalább 20 cm szabad helynek kell lennie. A készüléket tilos olyan helyiségben felállítani, amelyben 0 °C-os vagy az alatti hőmérséklet léphet fel (a készülék a megfagyó víz következtében károsodik).



-  **Figyelem!** Ha a hideg helyről érkező készüléket meleg helyiségben állítja fel, a bekapcsolás előtt várjon kb. 2 órát!



A kifröccsenésből eredő károk elkerülése érdekében javasoljuk, hogy helyezzen megfelelő alátétet a készülék alá.

-  A készüléket kizárólag földelt aljzathoz csatlakoztassa. Ne használjon földetlen dugaszolóaljzatot.

### 5.2 Víz betöltése

Minden bekapcsolás előtt győződjön meg arról, hogy van-e víz a víztartályban, és szükség esetén töltsse fel. A készüléknek az automatikus öblítéshez minden be- ill. kikapcsolási folyamatnál vízre van szüksége.

-  Vegye ki a víztartályt a készülékből (6. ábra). A víztartály kivétele előtt a gőzfúvókát mindig fordítsa a készülék közepe felé, máskülönben a tartály nem vehető ki.
-  Töltsse fel a víztartályt friss, hideg vízzel. Sohase töltsse a tartályt a MAX jelölés fölé.

-  A víztartályba kizárólag hideg vizet töltsön. Sohase töltsön bele egyéb folyadékot, pl. ásványvizet vagy tejet.
-  Helyezze be ismét a víztartályt (6. ábra). A tartályt erősen nyomja a helyére, hogy kinyíljon a víztartály szelepe.

-  Annak érdekében, hogy mindig aromás kávét kapjon:
- naponta cserélje a vizet a víztartályban,
  - a víztartályt hetente legalább egyszer tisztítsa meg normál mosogatóvízben (ne mosogatógépben). Utána öblítse át friss vízzel.

### 5.3 A babkávé tartályának feltöltése

-  Hajtsa fel a babkávé tartályának fedelét, és töltsse fel a tartályt friss babkávával (7. ábra). Ezt követően ismét zárja le a fedelet.

-  **Vigyázat!** Ne tegyen fagyasztott vagy karamellezett kávészemeket a kávétartályba, csak pörkölt babkávét! Győződjön meg arról, hogy nem

(H)

kerül idegen test, pl. kavics a babkávétartályába. **Ha a daráló megakad vagy megsérül egy idegen test miatt, az lehet, hogy nem esik a garancia hatálya alá.**

- i** A daráló gyárilag közepes őrlési finomságra van beállítva. Szükség esetén módosíthatjuk ezt a beállítást. Az őrlési finomság módosítására vonatkozó tudnivalókat lásd: „Az őrlési finomság beállítása”, 263. oldal.

**!** **Az őrlési finomságot csak őrlés közben szabad módosítani. Az álló darálón végzett beállítás a kávégép sérülését okozhatja.**

- i** A kávégépet gyárilag ellenőrizték. Ehhez kávéet használtak, így teljesen normális, ha a darálóban némi kávé található. Minden esetben garantáljuk, hogy a kávégép új.

#### 5.4 A készülék első bekapcsolása

A készülék első üzembe helyezésekor a kávégépet légteleníteni kell.

- ☞** Kapcsolja be a készüléket a hátoldalon található főkapcsolóval (8. ábra). Amikor a legelső alkalommal kapcsolják be a főkapcsolót, az önteszthez néhány másodpercre minden szimbólum világít a kijelzőn, azután villog a ☞ és a ▲ szimbólum.
- ☞** Töltse fel a víztartályt, lásd „Víz betöltése”, 255. oldal.
- ☞** Helyezze be ismét a víztartályt (6. ábra). A tartályt erősen nyomja a helyére, hogy kinyíljon a víztartály szelepe.
- ☞** Fordítsa ki a gőzfűvókát, és állítson alá egy csészét (9. ábra).
- ☞** A gőz és a forró víz forgatható gombját, amennyire csak lehet, fordítsa az óramutató járásával ellentétes irányban ☞ állásba (10. ábra). Némi víz lép ki a gőzfűvókából. Folyamatosan világít a ☞ és a ▲ szimbólum.

Amikor a csésze fel van töltve mintegy 30 ml vízzel, villogni kezd a ☞ és a ▲ szimbólum.

- ☞** A víz kifolyásának leállítására, amennyire csak lehet, fordítsa a gőz és a forró víz forgatható gombját az óramutató járásával megegyező irányban ● állásba (10. ábra). A ↓ szimbólum néhány másodpercig villog, és a készülék kikapcsol..
- ☞** Töltse fel a babkávétartályát babkávétal, lásd „A babkávétartályának feltöltése”, 255. oldal.

#### 5.5 A készülék bekapcsolása

Minden bekapcsolás előtt győződjön meg arról, hogy van-e víz a víztartályban, és szükség esetén töltse fel. A készüléknek az automatikus öblítéshez minden be- ill. kikapcsolási folyamatnál vízre van szüksége.

- ☞** Kapcsolja be a készüléket a „KI/BE” ⓪ gombbal (11. ábra).

- i** Közvetlenül a bekapcsolást követően a készülék beállítja önmagát. Az ezáltal keletkező zajok teljesen normálisak.

- i** A felfűtési folyamat alatt (kb. 120 másodperc) villog a ↓ szimbólum.

A felfűtés során a készülék automatikus öblítést végez (egy kevés forró víz kifolyik a kávékifolyón, ezt a csepptálca felfogja).

A felfűtés befejeztével a ↓ szimbólum folyamatosan világít.

A készülék ekkor üzemkés. A legutóbb használt kávékészítési módnak megfelelő szimbólumok világítanak.

#### 5.6 A készülék kikapcsolása

- ☞** Kapcsolja ki a készüléket a „KI/BE” ⓪ gombbal (11. ábra).

Villog a ↓ jelzés. A készülék öblítést végez, majd kikapcsol.



**i** Ha a készüléket hosszabb ideig nem használják, akkor 3 óra elteltével energiatakarékosági okokból automatikusan kikapcsol.

**i** Ha hosszabb ideig nem használjuk a készüléket, a „KI/BE” gombbal történő kikapcsolás után kapcsoljuk ki a készülék hátoldalán található főkapcsolót is (8. ábra).

### 5.7 A vízkeménység beállítása

Az első üzembe helyezés után ill. más vízminőség használata esetén a készüléket be kell állítani a helyi vízkeménységnek megfelelő keménységi fokra. A keménységi fok meghatározásához használja a mellékelt tesztcsíkot, vagy kérdezze meg a vízműveket.

#### A vízkeménységi fokozat meghatározása

 Mártsa a tesztcsíkot kb. 1 másodpercre hideg vízbe. Rázza le a felesleges vizet, és a rózsaszínre színeződött mezők alapján határozza meg a keménységi fokozatot.



**Nulla** vagy **egy** rózsaszín mező:  
**1. keménységi fokozat, lágy**  
 max. 1,24 mmol/l, ill.  
 max. 7 német keménységi fok, ill.  
 max. 12,6 francia keménységi fok



**Két** rózsaszín mező:  
**2. keménységi fokozat, közepesen kemény**  
 max. 2,5 mmol/l, ill.  
 max. 14 német keménységi fok, ill.  
 max. 25,2 francia keménységi fok



**Három** rózsaszín mező:  
**3. keménységi fokozat, kemény**  
 max. 3,7 mmol/l, ill.  
 max. 21 német keménységi fok, ill.  
 max. 37,8 francia keménységi fok







**Négy** rózsaszín mező:  
**4. keménységi fokozat, nagyon kemény**  
 3,7 mmol/l felett, ill.  
 21 német keménységi fok felett, ill.  
 37,8 francia keménységi fok felett

#### A meghatározott vízkeménységi fokozat beállítása és tárolása





A beállítható keménységi fokozatok száma 4. A készülék gyárilag a 4. keménységi fokozatra van beállítva.

 Bekapcsolt készüléknél nyomja meg a „P” gombot (4. ábra).

Folyamatosan világít a „P” és a  szimbólum. Ezenkívül a gombok pillanatnyi funkciójának jelzésére a , a  és a  gomb felett világít a 3 kicsi szimbólum, lásd „Speciális üzemmód”, 255. oldal.

 Nyugtázza a választást az „OK” gombbal (5. ábra).

A kijelzőn a jelenlegi beállítás látható. A keménységi fokozatok kijelzése a következő:

 keménységi fokozat 1  
 keménységi fokozat 2  
 keménységi fokozat 3  
 keménységi fokozat 4

 Ezután nyomja meg a lapozásra szolgáló „<” vagy „>” gombot (5. ábra) annyiszor, hogy a kijelzőn a meghatározott keménységi fokozat jelenjen meg.

 Nyugtázza a választást az „OK” gombbal (5. ábra). A készülék megjegyzi ezt a keménységi fokozatot.

**i** Az eltárolás nélküli megszakításhoz az „OK” helyett a „P”-t nyomja meg. Ha nem nyomják meg az „OK” gombot, a készülék kb. 120 másodperc után a bevitel mentése nélkül automatikusan visszatér kávékészítési üzemmódba.

 A kávékészítési üzemmódba való visszatéréshez végül nyomja meg a „P” gombot (4. ábra) vagy várjon kb. 120 másodpercet, míg a készülék automatikusan visszatér kávékészítési üzemmódba.

H

## 6 Kávékészítés babkávéből

A babkávéből történő kávékészítés során a következő folyamat teljesen automatikusan megy végbe: őrlés, adagolás, préselés, előforrázás, forrázás és a leforrázott kávézacc kidobása.

Az őrlési finomság és az őrlési mennyiség beállításának lehetősége által a készülék egyedileg az Ön személyes ízléséhez állítható.



Ne tegyen fagyasztott vagy karamellezett kávészemeket a kávétartályba, csak pörkölt babkávét! Győződjön meg arról, hogy nem kerül idegen test, pl. kavics a babkávétartályába. **Ha a daráló megakad vagy megsérül egy idegen test miatt, az lehet, hogy nem esik a garancia hatálya alá.**





Ízlés szerint válasszon a „rövid” presszókávé és a kávéhabos „hosszú” kávé közül.



Válassza ki a kívánt csészeméretet a forgatható „csészeméret” gombbal (12. ábra). Megjelenik a kiválasztott csészeméret.



A csészeméret kijelzése a következő:

-  presszócsésze
-  kis csésze
-  közepes csésze
-  nagy csésze
-  bögre





Kiválaszthatja, hogy kávéja extra-könnyű, könnyű, normál, erős vagy extraerős ízű legyen.



Válassza ki a kívánt kávéerősséget a forgatható „kávéerősség” gombbal (13. ábra). Megjelenik a kiválasztott kávéerősség.





A kávéerősség kijelzése a következő:



-  extra könnyű
-  könnyű
-  normál
-  erős
-  extraerős





Helyezzen egy vagy két csészét a kávékifolyó alá (14. ábra). A kifolyó fel- vagy lehúzásával a kifolyási magasság optimális módon a csésze magasságához illeszthető, a hővesztesség és a kávé kifröcskölésének csökkentése érdekében (15. ábra).





Egy csésze kávé készítéséhez nyomja meg az „1 csésze kávé”  gombot, ill. 2 csésze készítéséhez a „2 csésze kávé”  gombot.



Világít az „1 csésze”  vagy a „2 csésze”  jelzés. A készülék ekkor megőrli a babkávét. A kávékészítés során a készülék először kevés vízzel előforrázza az őrölt kávé. Rövid megszakítást követően megtörténik a tulajdonképpeni forrázás. A kávé kifolyik a csészébe.



Ha megtörtént a kívánt kávé mennyiség kiadása, a készülék automatikusan befejezi a kávékészítést, és az elhasznált őrölt kávé a zacstartályba dobja. Ez alatt az idő alatt villog az „1 csésze”  ill. a „2 csésze”  jelzés.



A kávékészítés bármikor befejezhető idő előtt az „1 csésze kávé”  vagy „2 csésze kávé”  gomb ismételt rövid megnyomásával, vagy a forgatható „csészeméret” gombot (12. ábra) az óramutató járásával ellentétes irányban a „presszócsésze” felé forgatva.



Amikor befejeződött a kávékiadás, a kávé mennyiség növelhető az „1 csésze”  vagy a „2 csésze”  gomb megnyomásával és a kívánt kávé mennyiség eléréséig történő nyomva tartásával, vagy a forgatható „csészeméret” gombot (12. ábra) az óramutató járásával megegyező irányban a „bögre” felé forgatva (közvetlenül a kávé kiadása után kell beavatkozni, mielőtt az elhasznált őrölt kávé a készülék a zacstartályba dobná).

A készülék pár másodperc elteltével – amikor kialszik az „1 csésze”  vagy a „2 csésze”  jelzés – ismét

üzemkész, és elkészíthető a következő kávé.

- i** Ha a kávé cseppenként ill. egyáltalán nem vagy túl gyorsan folyik ki, és a kávéhab nem ízlésének megfelelő, módosítsa az őrlés beállítását, lásd „Az őrlési finomság beállítása”, 263. oldal.
- i** Ha villog a ☰ és a ▲ jelzés, túl finomra van őrölve a kávé. Az őrlési finomság módosításához lásd: „Az őrlési finomság beállítása”, 263. oldal.
- i** Ha világít a ☰ jelzés, fel kell tölteni a víztartályt, különben a készülék nem tud kávé készíteni. (Az normális, hogy a jelzés megjelenésekor még van egy kevés víz a tartályban.)
- i** Ha világít a ☳ jelzés, tele van a zacctartály. Ki kell üríteni és meg kell tisztítani, lásd „A zacctartály kiürítése”, 264. oldal. Amíg a zacctartály meg nem tisztítják, a jelzés világít, és a kávégépet nem tud kávé készíteni.
- i** Kávékészítés közben sohase vegye ki a víztartályt. Ha kivette, a kávégépet már nem tud kávé készíteni. A kávégépet légtelenítése céljából, amennyire csak lehet, fordítsa a gőz és a forró víz forgatható gombját az óramutató járásával ellentétes irányban ☳☰ állásba, és néhány másodpercig folyassa a vizet a gőzfúvókából.
- i** A kávégépet első üzembe helyezésekor legalább 4-5 kávé kell készíteni, mielőtt a gép kielégítő eredményt nyújtana.



### 6.1 Tanácsok forróbb kávé kiadásához:

- Ha a rögtön a kávégépet bekapcsolása után kis csésze kávé kíván készíteni (60 ml-nél kevesebbet), használja az öblítés forró vizét a csészék előmelegítésére.
- A megfelelő menüben állítson be magasabb kávéhőmérsékletet, lásd „A kávéhőmérséklet beállítása”, 263. oldal.

- Ne használjon túl vastag csészét, kivéve ha előmelegíti őket, mivel az ilyenek túl sok hőt nyelnek el.
- Meleg vízzel kiöblítve vagy legalább 20 percre a bekapcsolt kávégépet fűtött csészétárolójára (H) állítva előmelegített csészéket használjon.

## 7 Több csésze kávé készítése a kanna funkcióval

Ezzel a funkcióval teljesen automatikusan készíthet **több csésze kávé közvetlenül a mellékelt nemesacél termoszkannába**: őrlés, adagolás, préselés, előforrzás, forrzás és a leforrzott kávézacc kidobása az előző fejezetben leírtak szerint.

-  Fordítsa a mellékelt nemesacél termoszkanna fedelét levélteli helyzetbe (16. ábra), és vegye le a fedelet. Öblítse át a kannát és a fedelet.
-  Helyezze a fedelet kiöntőállásban (17. ábra) a termoszkannára, és tegye azt a kávékifolyó (D) alá. A kávékifolyónak egészen feltolva kell lennie, hogy a termoszkanna behelyezhető legyen.





Világít a kanna funkció valamelyik szimbóluma, attól függően, hogy a kanna funkció utolsó használatkor hány csésze volt kiválasztva. Ezenkívül világít a „<” és a „>” lapozó szimbólum.

A kannába töltött csészék számának kijelzése a következő:

-  4 csésze
-  6 csésze
-  8 csésze
-  10 csésze





-  Győződjön meg arról, hogy a víztartály tele van, hogy elegendő babkávé van a babkávé tartályában, és hogy üres a zacctartály, hogy egy sorozat kávé lehessen készíteni a kannába.



H

- i** Ha módosítani kívánja a kanna funkció kávéerősségét és feltöltési mennyiségét, használja a „csészeméret” (12. ábra) ill. a „kávéerősség” (13. ábra) forgatható gombot, és a „Kávékészítés babkávéból”, 258. oldal c. részben leírtak szerint járjon el.
- ☞** Adott esetben a lapozásra szolgáló „<” vagy „>” gombbal válassza ki, hogy hány csésze kávé kíván a kannába készíteni (pl. 8 csészényihez válassza a  jelzést).
- ☞** Nyomja meg a „kanna”  gombot (18. ábra).  
A kávékészítés során villog a kiválasztott csészeszámnak megfelelő kannaszimbólum.  
Ha befejeződött a forrázás, felváltva villog az összes kannaszimbólum, a kiválasztott csészeszám szimbóluma pedig kétszer olyan hosszán világít, mint a többi.
- ☞** Vegye ki a termoszkannát, és zárja le a fedelet (19. ábra), hogy hosszú időn át melegen tartsa a kávé.  
A készülék automatikusan visszatér kávékészítés üzemmódba..
- i** A készülék megszakítja a folyamatot és leáll a futó program, ha túl kevés a betöltött babkáv vagy túl kevés víz van a víztartályban a kívánt funkció végrehajtásához, illetve ha tele van a zacstartály. A hiba elhárítása után újra kell indítani a programot. Ekkor, annak érdekében, hogy ne töltsük túl a kannát, figyelembe kell venni a már a kannában található kávé-mennyiséget is.
- i** Ha villog a  és a  jelzés, túl finomra van őrölve a kávé. Az őrlési finomság módosításához lásd: „Az őrlési finomság beállítása”, 263. oldal.

## 8 Kávékészítés őrölt kávéból

Ezzel a funkcióval már megőrölt kávé, pl. koffeinmentesített kávé forrázható.

- !** Figyelem! Győződjön meg arról, hogy nem kerül idegen test a rekeszbe, és hogy az őrölt kávé nem akadt fenn a rekeszben. A betöltőrekesz nem készletezőtartály, az őrölt kávé közvetlenül a forrázóegységhez kerül.
- ☞** Az őrölt kávé funkció kiválasztásához forgassa a „kávéerősség / őrölt kávé” gombot (20. ábra) a kívánt helyzetbe:  (1 csészéhez) vagy  (2 csészéhez). Ezáltal üzenem kívül helyezi a kávédarálót. Világít egy  jelzés (1 csészéhez) vagy mindkét  jelzés (2 csészéhez).
- ☞** Nyissa fel az őrölt kávé rekeszének fedelét, és töltsön bele friss őrölt kávé (21. ábra).

Csak a mellékelt mérőkanalat használja. Sohase töltsön be 2 csapott mérőkanálnál többet, különben vagy nem készít kávé a készülék, és az őrölt kávé szétoslik a gépben és elszennyezi azt, vagy a kávé cseppenként folyik ki, és villog a  és a  jelzés.



Kávéfőzés közben ne töltsön be őrölt kávé. A következő csészéhez való őrölt kávé csak a kávéfőzés teljes befejezése után töltsse be, amikor a készülék ismét üzemkész. Kikapcsolt gépbe sohase töltsön őrölt kávé, mivel máskülönben az szétoslik a készülék belsejében.







- !** Csak automata presszógépekhez való őrölt kávé használjon. Ne töltsön babkávét, vízben oldható, fagyasztva szárított azonnal oldódó terméket vagy más italport a rekeszbe. A túl finomra őrölt kávé dugulást okozhat.

**i** Ha eldugult a betöltőrekesz (a készülékbe jutott nedvesség miatt, vagy mert több mint 2 mérőkanál őrölt kávét töltöttek be) az őrölt kávé lejjebb tolására használjon kést vagy kanálnyelet (22. ábra). Ezután vegye ki a forrázóegységet és tisztítsa meg a kávégéppel együtt, lásd „A forrázóegység tisztítása”, 265. oldal.

 Zárja le a fedelet.

 Válassza ki a kívánt csészeméretet a forgatható „csészeméret” gombbal (12. ábra), a „Kávékészítés babkávéból”, 258. oldal c. részben leírtak szerint.

 Egy csésze kávé készítéséhez nyomja meg az „1 csésze kávé”  gombot, ill. 2 csésze készítéséhez a „2 csésze kávé”  gombot. Elkészül a kávé.

**i** Ha az őrölt kávé 1 csészehez funkció lett kiválasztva és nem töltöttek őrölt kávét az őrölt kávé rekeszébe, a  gomb megnyomása után villog a  és a  jelzés. Ha az őrölt kávé 2 csészehez funkció lett kiválasztva és nem töltöttek őrölt kávét az őrölt kávé rekeszébe, a  gomb megnyomása után villog a  és a  jelzés.





**i** Ahhoz, hogy a kávé elkészítése után ismét visszatérjünk babkávét üzemmódba, forgassuk el a „kávéeórség / őrölt kávé” gombot (20. ábra) egy tetszőleges kávéeórség-beállításra (ismét lehetségessé válik a kávédaráló üzeme).

## 9 Tejhabosítás

A gőz használható tej habosítására és folyadékok felforrósítására. Mivel a gőz létrehozásához a kávékészítésnél magasabb hőmérséklet szükséges, a készülék kiegészítő gőz üzemmóddal rendelkezik.



**i** Egy adag cappuccinóhoz töltsön meg egy nagy csészét félig vagy 2/3-ig presszókávéval, majd adja hozzá a felhabosított tejet.

**!** Vigyázat! Bekapcsolt gőzfűvóka esetén forrázásveszély áll fenn! A kilépő forró víz ill. forró vízgőz égési sérülést okozhat. Ezért a gőzfűvókát csak akkor kapcsolja be, ha az már belemerült a tejsbe.

 A gőz előkészítéséhez nyomja meg a „gőz” gombot  (23. ábra). Világít a  szimbólum, és felfűt a készülék. A felfűtés során villog a  szimbólum..

A felfűtés befejeztével a  szimbólum folyamatosan világít.

**i** Ha a gőzfunkciót 2 percnél hosszabb ideig nem használják, a készülék automatikusan visszkapcsol kávékészítés üzemmódba.

**i** Annak érdekében, hogy a maradék víz habosítás közben bele ne keveredjen a tejsbe, előzőleg eressze le a vizet. Ehhez tartson egy edényt a gőzfűvóka alá, és fordítsa a gőz és a forró víz forgatható gombját (10. ábra)   pozícióba. Hagyja ebben a helyzetben, amíg gőz nem képződik. Ezt követően fordítsa vissza a forgatható váltókapcsolót  pozícióba.

 Öntsön zsírszegény, hideg tejet egy a készülék gőzfűvókája alá illő bögrébe.



**i** A tej legyen jól behűtve. Az edény (lehetőleg nemesacél bögre) szintén legyen hideg, ne öblítse ki előzőleg meleg vízzel.

 Hajtsa ki a gőzfűvókát, és tartsa a bögrét a gőzfűvóka alá, hogy a fűvókanyílás éppen belemerüljön a tejsbe (24. ábra).

**!** **Figyelem!** A gőzfűvókát szennyező beszáradt tejmaradványok veszélyt jelenthetnek. Ügyeljen arra, hogy ne merítse a gőzfűvókát a tejsbe olyan mélyen, hogy a tej ellepje a gőzfűvóka felső részén található légszivónyí-



H

lást. Ezáltal a tej beszívódna a fűvókába, és esetleg a fűvóka szennyeződését idézné elő.

 Fordítsa a gőz és a forró víz forgatható gombját (10. ábra)  pozícióba. Megtörténik a tej felhabosítása.

 Krémesebb tejhab készítéséhez az edényt mozgassa lassan alulról felfelé. A tejet legalább térfogatának megduplázódásáig habosítsa fel.



 Azt ajánljuk, hogy 2 percnél hosszabban megszakítás nélkül ne gőzöljön.

 A habosítás befejezéséhez fordítsa a gőz és a forró víz forgatható gombját (10. ábra)  pozícióba, majd távolítsa el az edényt.



 **Vigyázat!** A kifröccsenő, forró tej forrázásveszéllyel jár! Kapcsolja le a gőzt, mielőtt kivesszi a felhabosított tej edényét.

 A gőzölési üzemmódból való kilépéshez nyomja meg a „gőz” gombot (23. ábra) vagy várjon kb. 120 másodpercet, amíg a készülék automatikusan visszatér a kávékészítési üzemmódhoz.

A készülék ekkor ismét kész a kávékészítésre.

 Tejhabosítás után a gőz és a forró víz forgatható gombját (10. ábra)  pozícióba fordítva mindig folyasson ki még egy kevés forró vizet a fűvókán.



Ez szükséges ahhoz, hogy a tejszáradványok ne száradjanak a fűvókába, és ne tömítsék el a fűvókát. Ilyenkor használjon egy alkalmas felfogóedényt. Ezalatt világít a  szimbólum.

 Ezután állítsa a gőz és a forró víz forgatható gombját a  pozícióra, a kijelzőn a legutóbb kiválasztott kávékészítési beállítás látható.

### 9.1 A gőzfűvóka megtisztítása

**Fontos:** Higiéniai okokból azt ajánljuk, hogy az alábbiakban leírt folyamatot minden alkalommal hajtsa

vége, miután tejet habosított. Ezzel elkerülhető, hogy a tej lerakódjon a gőzfűvóka belsejében.

 Fordítsa a gőz és a forró víz forgatható gombját az óramutató járásával megegyező irányban ütközésig  pozícióba. Várjon pár percet, amíg lehül a gőzfűvóka.

 Azután fogja meg a forgatható cső fekete fogantyúját, és az óramutató járásával megegyező irányban enyhén elforgatva nyissa ki a gőzfűvóka bajonettzárát. Húzza le a gőzfűvókát lefelé (25. ábra).

 A gőzfűvóka belső részét lefelé húzza le a forgatható csőről.

 Tisztítsa meg a gőzfűvókát és a belső részt meleg vízzel.

 Ellenőrizze, hogy nincs-e eldugulva a 26. ábrán jelölt két furat. Adott esetben túvel szűrje át és tisztítsa meg őket.

 Óvatosan a forgatható csőre dugva szerelje fel ismét a belső részt.



 Ismét feltolva és az óramutató járásával ellentétes irányban elforgatva szerelje ismét fel a gőzfűvókát.

## 10 Forró víz készítése

A forró víz csészék előmelegítésére és forró italok, pl. tea vagy zacskós leves készítésére használható.

 **Vigyázat!** Bekapcsolt forróvízfűvóka esetén forrázásveszély áll fenn! A kilépő forró víz égési sérülést okozhat. A forróvízfűvókát csak akkor kapcsolja be, ha van edény a forróvízfűvóka alatt.

 Állítson egy edényt a forróvízfűvóka alá.

 Fordítsa a gőz és a forró víz forgatható gombját  pozícióba (10. ábra). Megtörténik a forró víz kiadása, világít a  szimbólum.

 Azt ajánljuk, hogy 2 percnél hosszabban megszakítás nélkül ne folyassa a forró vizet.

-  A forróvíz-vételt követően fordítsa vissza a gőz és a forró víz forgatható gombját ● pozícióba (10. ábra), majd távolítsa el az edényt.

## 11 Az őrlési finomság beállítása

A daráló gyárilag közepes őrlési finomságra van beállítva.

Amennyiben a kávékiadás túl gyors vagy túl lassú (cseppenkénti) volna, az őrlés során módosíthatja az őrlési finomságot.

-  **Az őrlési finomságot csak az őrlési folyamat alatt szabad állítani, azaz az őrlési finomság beállító gombját (2. ábra, T tétel és 27. ábra) csak olyankor szabad elfordítani, amikor a kávékészítés során a daráló babkávét őröl. Az álló darálón végzett beállítás a kávégép sérülését okozhatja.**

-  Az őrlési finomság beállító gombjával (2. ábra, T) állítsa be az őrlési finomságot (27. ábra).

- Ha a kávé cseppenként ill. egyáltalán nem folyik ki (esetleg villog a ☰ és a ▲ jelzés), a gombot egy pozícióval el kell fordítani az óramutató járásával megegyező irányban. Mindig egy pozícióval fordítsa odébb, egészen a kielégítő kávékiadás eléréséig.

- Amennyiben túl gyorsan folyik ki a kávé, és a kávéhab sem felel meg az ízlésének, fordítsa vissza a gombot egy pozícióval, az óramutató járásával ellentétes irányba.

-  Ügyeljen arra, hogy az őrlési finomság beállító gombját ne fordítsa el túlságosan, különben 2 kávé készítésekor esetleg cseppenként fog kifolyni a kávé.

-  E korrekció hatása azonban csak legalább 2 kávékészítéssel később észlelhető.

## Idegen testek eltávolítása a darálóból

A darálóban található idegen testek, pl. kavicsok károsíthatják a darálót. A kávéban található idegen test egyenletes, hangos kattogást okoz. Ha a darálás alatt ilyen zajt hall, haladéktalanul kapcsolja ki a készüléket, és forduljon a vevőszolgálathoz. **Ha a daráló megakad vagy megsérül egy idegen test miatt, az lehet, hogy nem esik a garancia hatálya alá.**

## 12 A kávéhőmérséklet beállítása

Három hőmérsékleti fokozat közül lehet választani. A gyári beállítás a „magas hőmérséklet”. Ezt a következőképpen módosíthatja:

-  Nyomja meg a „P” gombot (4. ábra). Folyamatosan világít a „P” és a ☰ szimbólum. Ezenkívül a gombok pillanatnyi funkciójának jelzésére a ☐, a ☐☐ és a ☐☐☐ gomb felett világít a 3 kicsi szimbólum, lásd „Speciális üzemmód”, 255. oldal.

-  Nyomja meg a lapozásra szolgáló „<” vagy „>” gombot (5. ábra) annyiszor, hogy a ↓ jelzés világítson.

-  Nyugtázza az „OK” gombbal (5. ábra).

A kijelzőn a jelenlegi beállítás látható. A hőmérséklet kijelzése a következő:

- ☐ alacsony hőmérséklet
- ☐☐ közepes hőmérséklet
- ☐☐☐ magas hőmérséklet

-  A lapozásra szolgáló „<” vagy „>” gomb (5. ábra) segítségével adott esetben válasszon más hőmérsékletet.

-  Amikor megjelenik a kívánt hőmérséklet, nyugtázza az „OK” gombbal (5. ábra). Ezzel a kívánt hőmérséklet került beállításra.

-  Az eltárolás nélküli megszakításhoz az „OK” helyett a „P”-t nyomja meg.

H

**i** Ha nem nyomják meg az „OK” gombot, a készülék kb. 120 másodperc után a bevitel mentése nélkül automatikusan visszatér kávékészítési üzemmódba.

**☞** A kávékészítési üzemmódba való visszatéréshez végül nyomja meg a „P” gombot (4. ábra) vagy várjon kb. 120 másodpercet, míg a készülék automatikusan visszatér kávékészítési üzemmódba.

## 13 Tisztítás és ápolás

A kávé egyenletes minősége és a zavarmentes működés érdekében készülékét tartsa mindig tisztán.

### 13.1 Rendszeres tisztítás

**⚠ Vigyázat!** Tisztítás előtt kapcsolja ki a készüléket! Hagyja lehűlni a készüléket!

**⚠ Figyelem!** A készüléket és annak részeit sohase tegye mosogatógépbe. A kávégépet sohase merítse vízbe.

**⚠ Figyelem!** Sohase öntsön vizet a babkávé tartályába, a víz károsítja a darálót.

**⚠** Ne használjon karcoló, súroló vagy maró szereket. A házat kívül és belül csak nedves kendővel törölje le.

**☞** Naponta vegye ki a víztartályt (6. ábra), és öntse ki a maradék vizet. Friss vízzel öblítse ki a víztartályt. Használjon naponta friss vizet.

**☞** A zacctartályt ürítse ki naponta, vagy legkésőbb amikor a kijelzőn erre felhívó üzenet jelenik meg, lásd „A zacctartály kiürítése”, 264. oldal.

**☞** Rendszeresen ürítse ki a csepptálcát, de a legkésőbb akkor, amikor a csepptálca piros úszója (28. ábra) megjelenik a csepegtetőrács nyílásában.

**☞** Rendszeresen, hetente legalább egyszer tisztítsa meg a víztartályt (N), a csepptálcát (O), a csepegtetőrácsot (A) és a zacctartályt (Q) meleg vízzel,

enyhe mosogatószerrel és esetleg ecsettel.

**☞** Minden habosítás után vegye le a gőzfúvókát és gondosan tisztítsa meg a tejmaradványoktól, lásd „A gőzfúvóka megtisztítása”, 262. oldal.

**☞** Ellenőrizze, hogy nincsenek-e eldugulva a kávékifolyó nyílásai. Tisztításként túlvél távolíthatja el a beszáradt kávé (29. ábra).

### 13.2 A zacctartály kiürítése

A készülék számolja az elkészített kávékat. 14 egycsészes (vagy 7 kétsészes) kávékészítés után világít a ☞ szimbólum, amely arra utal, hogy tele van a zacctartály, ki kell üríteni és meg kell tisztítani. Amíg a zacctartályt meg nem tisztítják, a kávégép nem tud kávé készíteni.

**☞** Tisztításhoz a megfelelő nyitógombot megnyomva reteszelve ki és nyissa fel a karbantartónyílást (30. ábra), ekkor világít a ☞ szimbólum.

**☞** Ezután vegye ki és tisztítsa meg csepptálcát (31. ábra).

**☞** Gondosan ürítse ki és tisztítsa meg a zacctartályt. Kérjük, ügyeljen arra, hogy eltávolítson a fenékre lerakódott minden maradványt.

**Fontos:** Minden alkalommal, amikor kihúzza a csepptálcát, ki **kell** üríteni a zacctartályt is, még ha az nincs is egészen tele. Ha nem hajtjuk végre ezt a műveletet, akkor a rákövetkező kávékészítésekénél előfordulhat, hogy a zacctartály túlságosan megtelik, és a túlcserdülő kávézacc eltömíti a kávégépet.







**i** Ha kivette a csepptálcát, villog a ☞ szimbólum.

**i** A készülék napi használata esetén a tartályt is naponta ürítse ki. A zacctartályt mindig bekapcsolt készüléknél ürítse ki. A készülék csak így ismeri fel az ürítést.



### 13.3 A daráló tisztítása

Az őrölt kávé maradványai puha ecsettel vagy porszívóval távolíthatók el a babkávétartályból.

-  **Figyelem!** Sohase öntsön vizet a darálóba, a víz károsítja a darálót.
-  Kapcsolja ki a készüléket a KI/BE gombbal (11. ábra) és a főkapcsolóval (8. ábra). Húzza ki a hálózati csatlakozódugót.
-  Távolítsa el a maradék kávészemeket (pl. használjon tömlős vagy résszívós porszívót).
-  Ha egy idegen test nem távolítható el, forduljon a vevőszolgálathoz. **Ha a daráló megakad vagy megsérül egy idegen test miatt, az lehet, hogy nem esik a garancia hatálya alá.**
-  **Vigyázat!** A forgó daráló sérülésveszélyt okoz. Sose kapcsolja be a készüléket, amikor a darálón dolgozik. Ez rendkívül súlyos sérüléseket okozhat. Feltétlenül húzza ki a hálózati csatlakozódugót.
-  Kevés babkávével kávé készítve próbálja ki a daráló működését. Az első darálás alkalmával vagy tisztítás után kevesebb kávé kerül a forrázóegységbe, mivel fel kell tölteni a csatornát is. Ez hatással lehet az első kávéra.

### 13.4 A forrázóegység tisztítása

Javasoljuk, hogy a forrázóegységet (a használat gyakoriságától függően) rendszeresen tisztítsa meg. Mielőtt a készüléket hosszabb időre leállítja (pl. nyaraláskor), a zacctartályt és a víztartályt ki kell üríteni, és a készüléket – a forrázóegységet is beleértve – alaposan meg kell tisztítani.



A következőképpen járjon el:

-  A KI/BE gomb (11. ábra) megnyomásával kapcsolja ki a kávégépet (ne húzza ki a hálózati csatlakozódugót) és várjon, amíg ki nem alszik minden szimbólum!

-  A megfelelő nyitó gombot megnyomva reteszelve ki és nyissa fel a karbantartónyílást (30. ábra).

-  Vegye ki és tisztítsa meg cseptálcát és a zacctartályt (31. ábra).

-  Nyomja meg a forrázóegység két piros kioldógombját oldalra és középfelé (32. ábra), és húzza ki a forrázóegységet.

 **Figyelem! A forrázóegység csak akkor vehető ki, ha a készüléket a készülék elülső oldalán található KI/BE  gombbal kikapcsolták. A készüléket nem kell leválasztani a hálózatról. Ha megkísérli a bekapcsolt kávégépből kivenni a forrázóegységet, súlyosan károsodhat a gép.**

-  A forrázóegységet mosogatószer használata nélkül, folyó vezetékes víz alatt tisztítsa meg. **A forrázóegységet sohase tisztítsa mosogatógépben.**

-  Alaposan tisztítsa meg a gép belsejét. A kávégépre rásült kávémaradványokat fa vagy műanyag villával vagy hasonló, a felületet nem karcoló tárggyal kaparja le (33. ábra), majd porszívózzon ki minden maradványt (34. ábra).

-  Az ismételt behelyezéshez tegye a forrázóegységet (36. ábra, a) a tartóba (36. ábra, b) és tolja be a rögzítőcsapot (36. ábra, c). A rögzítőcsapot be kell vezetni a forrázóegységen alul található csőbe (36. ábra, d).



-  Ekkor nyomja meg erősen a PUSH feliratot (36. ábra, e), amíg a forrázóegység hallhatóan be nem kattant.

-  Miután hallotta a bekattanást, győződjön meg arról, hogy a piros gombok (36. ábra, f) ki vannak pattanva, máskülönben nem zárható be a karbantartónyílás.

37. ábra: A két piros gomb helyesen ki van pattanva.

38. ábra: A két piros gomb nincs kipattanva.

(H)

-  A zacstartállyal együtt helyezze vissza a csepptálcát.
-  Zárja le a karbantartónyílást.

 Ha a forrázóegység nincs megfelelően behelyezve, azaz a hallható kattánásig bepattintva, és a piros gombok nincsenek helyesen kipattanva, nem zárható be a karbantartónyílás.

 Ha a forrázóegység csak nehezen helyezhető be, akkor (behelyezés előtt) megfelelő magasságba kell állítani, mégpedig a 35. ábrán bemutatott módon alulról és felülről egyidejűleg erősen összenyomva a forrázóegységet.

 Amennyiben a forrázóegység még mindig nehezen helyezhető be, zárja le a karbantartónyílást, húzza ki a tápkábel csatlakozódugóját a dugaszolóaljzatból, majd dugja ismét vissza.

Várja meg, hogy minden szimbólum kialudjon, majd nyissa fel a karbantartónyílást, és helyezze be ismét a forrázóegységet.





### 13.5 A vízkőmentesítő program végrehajtása



A vízkőmentesítő program lehetővé teszi a készülék egyszerű és hatásos vízkőmentesítését. A készüléket vízkőmentesíteni kell, amikor a világító  szimbólum erre figyelmeztet.



 **Figyelem!** Semmi esetre se használjon az AEG/Electrolux által ajánlottak között nem szereplő vízkőmentesítőt. Más vízkőmentesítő szer használata esetén az AEG/Electrolux nem vállal felelősséget az esetleges károkért. Vízkőmentesítő folyadék kapható a szakkereskedésekben és az AEG/Electrolux szervizvonalán.



 A vízkő-mentesítési folyamat kb. 45 percig tart, és nem ajánlott megszakítani. Áramkimaradás esetén újra kell indítani a programot!

 A vízkő-mentesítési program elindítása előtt tisztítsa meg a forrázóegységet (lásd „A forrázóegység tisztítása”, 265. oldal).

 Nyomja meg a „P” gombot (4. ábra). Folyamatosan világít a „P” és a  szimbólum. Ezenkívül a gombok pillanatnyi funkciójának jelzésére a , a  és a  gomb felett világít a 3 kicsi szimbólum, lásd „Speciális üzemmód”, 255. oldal.

 Nyomja meg a lapozásra szolgáló „<” vagy „>” gombot (5. ábra) annyiszor, hogy a  jelzés világítson.



 Nyugtázza az „OK” gombbal (5. ábra). A  és a  szimbólum villog és a „P” folyamatosan világít.



 Ha most akarja megszakítani a vízkőmentesítő programot, kapcsolja ki a készüléket a „KI/BE”  gombbal (11. ábra).

 Ürítse ki a víztartályt, töltsse fel legalább 1 liter friss vízzel és tegye bele a vízkőoldó szert.



 Vigyázat: Győződjön meg arról, hogy az esetleg kifröccsenő vízkőoldó szer nem kerül olyan, savra érzékeny felületre, mint a márvány, a mészkő és a kerámia.



 Állítson legalább 1,5 liter űrtartalmú edényt a gőzfúvóka alá (9. ábra).

 Állítsa a gőz és a forró víz forgatható gombját  pozícióba.







Elindul a vízkő-mentesítési program és vízkőmentesítő folyadék folyik a gőzfúvókából. A , a  és a „P” szimbólum folyamatosan világít.



A vízkő-mentesítési program automatikusan végrehajt egy sor öblítést (szünetekkel elválasztva), hogy eltávolítsa a vízkőlerakódásokat a kávégép belsejéből.





Mintegy 30 perc elteltével a víztartály kiürül, a  és a  szimbólum villog és a „P” folyamatosan világít.

 Állítsa vissza a gőz és a forró víz forgatható gombját  pozícióba.

A készülék ekkor elő van készítve a friss vízzel való öblítésre.

-  Vegye ki a víztartályt, töltsse fel friss vízzel, majd helyezze vissza.
-  Ürítse ki a gőzfúvóka alatti edényt, majd helyezze ismét a gőzfúvóka alá.
-  Állítsa a gőz és a forró víz forgatható gombját  pozícióba.  
A készülék a friss vízzel öblítést végez, öblítővíz folyik a gőzfúvókából. A , a  és a „P” szimbólum folyamatosan világít.

Pár perc elteltével a víztartály kiürül, a  és a  szimbólum villog és a „P” folyamatosan világít.

-  Állítsa vissza a gőz és a forró víz forgatható gombját  pozícióba.  
A legutóbb kiválasztott kávékészítési üzemmódnak megfelelő szimbólumok láthatók, és folyamatosan világít a  szimbólum.
-  Ürítse ki az öblítővízes edényt.
-  Vegye ki a víztartályt, töltsse fel friss vízzel, majd helyezze vissza.  
A készülék ekkor ismét üzemkész állapotban, az utoljára kiválasztott kávékészítési üzemmódban van.

-  Javasoljuk, hogy a vízkömentesítő program futtatása utáni első csésze kávént öntse ki.

## 14 Tartozékrendelés

Annak érdekében, hogy sokáig öröme teljen készülékében, valamint az idő előtti meghibásodások elkerülésére a készüléket rendszeresen tisztítani és vízkömentesíteni kell. Az eredeti vízkömentesítő szert megvásárolhatja közvetlenül tőlünk is.



Németországban kérjük, forduljon rendelési forródrótunkhoz:

1801 - 20 30 60\*



(\* A Deutsche Telekom vezetékes hálózatáról helyi díjjal hívható) hétfőtől péntekig 8.00 órától 18.00 óráig.

## 15 Mi a teendő, ha a kijelzőn az alábbi üzenet jelenik meg?

### Folyamatosan világít a jelzés

- A víztartály üres vagy nem megfelelően van behelyezve:
-  Töltsse fel és helyezze be előírászerűen a víztartályt, lásd „Víz betöltése”, 255. oldal.
- Szennyezett a víztartály, vagy vízkőkéreg képződött rajta.
-  Öblítse ki vagy vízkömentesítse a víztartályt.

### Villog a és a jelzés

- A kávégép nem tud kávé készíteni.
-  Állítson egy edényt a gőzfúvóka alá és fordítsa a gőz és a forró víz forgatható gombját az óramutató járásával ellentétes irányban  pozícióba (9. ábra).
- A kávé túl lassan folyik ki.
-  Fordítsa az őrlési finomság beállító gombját (12. ábra) az óramutató járásával megegyező irányban egy pozícióval odébb, mialatt a daráló a kávékészítés során babkávét őröl (lásd „Az őrlési finomság beállítása”, 263. oldal).

### Folyamatosan világít a jelzés

- A zacstartály megtelt.
-  „A zacstartály kiürítése”, 264. oldal részben leírtak szerint ürítse ki, tisztítsa meg és helyezze ismét be a zacstartályt.

### Villog a jelzés

- A zacstartályt a tisztítás után nem helyezték vissza.
-  Nyissa fel a karbantartónyílást, és helyezze be a zacstartályt.

(H)

**Villog a ☞ vagy a ☞☞ és a ▲ jelzés**

- Az őröltkávé-funkció kiválasztása után nem töltöttek őrölt kávé a betöltőrekeszbe.
- ☞ Töltse be az őrölt kávé, lásd „Kávékészítés őrölt kávéból”, 260. oldal.

**Villog a kávéerősség minden ☞☞☞☞☞ szimbóluma és a ▲ jelzés**

- Nincs több babkávé a babkávé tartályában.
- ☞ Töltse fel a babkávé tartályát, lásd „A babkávé tartályának feltöltése”, 255. oldal.
  - Ha túl hangossá válik a daráló, az azt jelentheti, hogy a babkávéban lévő kis kavics megakasztotta a darálót.

☞ Forduljon a vevőszolgálathoz. **Ha a daráló megakad vagy megsérül egy idegen test miatt, az lehet, hogy nem esik a garancia hatálya alá.**

**Folyamatosan világít a ☞ jelzés**

- Azt jelzi, hogy a kávégép elvízkövesedett.
- ☞ A lehető leghamarabb végre kell hajtani a vízkő-mentesítési programot, lásd „A vízkőmentesítő program végrehajtása”, 266. oldal.

**Folyamatosan világít a ☞ jelzés**

- Nyitva van a karbantartónyílás.
- ☞ Zárja le a karbantartónyílást. Ha a karbantartónyílás nem volna lezárható, győződjön meg arról, hogy helyesen van-e behelyezve a forrázóegység (lásd „A forrázóegység tisztítása”, 265. oldal).

**Villog a ▲ jelzés**

- Valószínűleg elfelejtették visszatenni a forrázóegységet a kávégépbe a tisztítás után.
- ☞ Helyezze be a forrázóegységet, lásd „A forrázóegység tisztítása”, 265. oldal.

- A gép nagyon szennyezett.

☞ Alaposan tisztítsa meg a gép belsejét, lásd „A forrázóegység tisztítása”, 265. oldal. Ha a tisztítás elvégzését követően a kávégép még mindig ilyen üzenetet jelenít meg, kérjük, forduljon a vevőszolgálathoz.

**Folyamatosan világít a ▲ jelzés**

- Ez egy általános figyelmeztetés.
- ☞ Kérjük, forduljon a vevőszolgálathoz.

**Villog a ☞☞ és a ▲ jelzés**

- A készüléket úgy kapcsolták be, hogy a gőz és a forró víz forgatható gombja „nyitva” ☞☞ pozícióban volt.
- ☞ Fordítsa a gőz és a forró víz forgatható gombját az óramutató járásával megegyező irányban ütközésig ● pozícióba.

**Villog a ☞ és a ▲ jelzés**

- A készülék üzemeltetéséhez túl alacsony a környezeti hőmérséklet.
- ☞ Melegebb helyiségben üzemeltesse a készüléket.

## 16 A vevőszolgálat nélkül megoldható problémák

Amennyiben nem működik a kávégép, könnyen megtalálhatja és elháríthatja az üzemzavar okát, ha tanulmányozza az alábbi fejezetet: „Mi a teendő, ha a kijelzőn az alábbi üzenet jelenik meg?”, 267. oldal. Ha azonban a kávégépen nem látható jelzés, kérjük, végezze el az alábbi ellenőrzéseket, mielőtt a vevőszolgálathoz fordul.

**Nem elég forró a kávé**

- Nem melegítették elő a csészéket.
- ☞ Melegítse elő a csészéket úgy, hogy vízzel kiöblíti vagy legalább 20 perc-re a fűtött csészetárolóra (H) állítja őket (lásd „Tanácsok forróbb kávé kiadásához”, 259. oldal).

**Kevés a kávéhab**

- Túl durvára van őrölve a kávé.
- ☞ Fordítsa az őrlési finomság beállító gombját az óramutató járásával ellentétes irányban egy pozícióval odébb, mialatt a daráló a kávékészítés során babkávét őröl (lásd „Az őrlési finomság beállítása”, 263. oldal).
- Nem alkalmas a kávékeverék.
- ☞ Használjon kávéautomatához alkalmas kávékeveréket.

**A kávé túl lassan folyik ki.**

- Túl finomra van őrölve a kávé.
- ☞ Fordítsa az őrlési finomság beállító gombját az óramutató járásával megegyező irányban egy pozícióval odébb, mialatt a daráló a kávékészítés során babkávét őröl (lásd „Az őrlési finomság beállítása”, 263. oldal).

**A kávé túl gyorsan folyik ki.**

- Túl durvára van őrölve a kávé.
- ☞ Fordítsa az őrlési finomság beállító gombját az óramutató járásával ellentétes irányban egy pozícióval odébb, mialatt a daráló a kávékészítés során babkávét őröl (lásd „Az őrlési finomság beállítása”, 263. oldal).

**Csak az egyik kávékifolyóból jön kávé.**

- Eldugultak a kifolyók furatai.
- ☞ A beszáradt kávé tüllel távolíthatja el (29. ábra).

**A gőz és a forró víz forgatható gombjának elfordítása ellenére nem jön gőz a gőzfűvókából.**

- Eldugultak a gőzfűvóka és a gőzfűvóka belső részének kis furatai.
- ☞ Tisztítsa meg a gőzfűvóka és a gőzfűvóka belső részének kis furatait (lásd „A gőzfűvóka megtisztítása”, 262. oldal).

**Ha ☞ vagy ☞☞ funkció van kiválasztva, nem kávé, hanem víz folyik a gépből.**

- Az őrölt kávé megakadhatott a betöltőrekeszben.
- ☞ Kés segítségével távolítsa el a betöltőrekeszt eltömítő őrölt kávé (lásd „Kávékészítés őrölt kávéból”, 260. oldal) (22. ábra). Ezután tisztítsa meg a forrázóegységet és a gép belsejét (lásd „A forrázóegység tisztítása”, 265. oldal).

**A gép nem kapcsol be a ① gomb megnyomásakor.**

- Nincs bekapcsolva a készülék hátoldalán található főkapcsoló (8. ábra) vagy nincs bedugva a hálózati csatlakozódugó.
- ☞ Ellenőrizze, hogy a főkapcsoló „I” állásban áll-e, és hogy a hálózati kábel megfelelően be van-e dugva a dugaszolóaljzatba.

**A forrázóegység nem vehető ki tisztítás céljából.**

- Be van kapcsolva a kávégép. A forrázóegység csak kikapcsolt gépnél vehető ki.
- ☞ Kapcsolja ki a készüléket és vegye ki a forrázóegységet (lásd „A forrázóegység tisztítása”, 265. oldal).

**i** **Figyelem! A forrázóegység csak akkor vehető ki, ha a készüléket a készülék elülső oldalán található KI/BE ① gombbal kikapcsolták. A készüléket nem kell leválasztani a hálózatról. Ha megkísérli a bekapcsolt kávégépből kivenni a forrázóegységet, súlyosan károsodhat a gép.**

**A kávé nem a kávékifolyó nyílásain, hanem oldalt, a karbantartónyíláson folyik ki.**

- A kávékifolyó nyílásait eltömítette a beszáradt kávé.
- ☞ A beszáradt kávé tüllel távolíthatja el (29. ábra).

(H)



- A karbantartónyláson belül található mozgatható rekesz (R) megakadt és nem mozog.

 Alaposan tisztítsa meg a mozgatható rekeszt, különösen a zsanérok közelében, hogy azok mozgathatók maradjanak.

#### **Őrölt kávé használata (bábkávé helyett), és a gép nem ad kávé.**

- Túl sok őrölt kávé töltöttek be.

 Vegye ki a forrázóegységet, és alaposan tisztítsa meg a gép belsejét, lásd „A forrázóegység tisztítása”, 265. oldal. Ismétlje meg a kávékészítést és ennek során legfeljebb 2 csapott mérőkanál őrölt kávé használjon.

- A forgatható „kávéerősség / őrölt kávé” gombot nem  vagy  pozícióba állították, és a készülék felhasználta az őrölt kávé és a daráló által őrölt kávé is.

 Alaposan tisztítsa meg a gép belsejét, lásd „A forrázóegység tisztítása”, 265. oldal. Ismétlje meg a kávékészítést, és ennek során először állítsa a forgatható „kávéerősség / őrölt kávé” gombot a helyes pozícióba, lásd „Kávékészítés őrölt kávéból”, 260. oldal.

- Az őrölt kávé kikapcsolt gépnél töltöttek be.

 Vegye ki a forrázóegységet, és alaposan tisztítsa meg a gép belsejét, lásd „A forrázóegység tisztítása”, 265. oldal. Ismétlje meg a műveletet bekapcsolt gépnél.

#### **Mi a teendő, ha a készüléket szállítani kell?**

- Szállítási célokra őrizze meg az eredeti csomagolást. A karcolások elleni védelemre használja az eredeti műanyag zsákot.
- Biztosítsa a készüléket és a termoszkannát ütődés ellen. A szállítás során bekövetkező sérülésekért nem tudunk felelősséget vállalni.
- A készülék beküldésekor mindig mellékelje a termoszkannát is. A készülék próbájához szükség van rá.
- A víztartályt és a zacctartályt ürítse ki.
- Kérjük, fordítson gondot a készülék tárolási helyére, különösen hideg időben. Fagykarak keletkezhetnek.



## 17 Statisztika üzemmód

A készülék lehetőséget ad a következő értékek lekérdezésére:





- a készülékkel eddig elkészített összes kávék száma,
- a 4, 6, 8 vagy 10 csészes kannák száma,
- az elvégzett vízkömentesítések száma, és ezenkívül
- a készülékkel kiadott vízmennyiség literben mérve.

 Két csésze kávé egyidejű elkészítése esetén a készülék két csésze elkészítését is számolja.

A statisztika üzemmód bekapcsolásához a készüléknek kikapcsolt állapotban kell lennie.

 Szükség esetén a „KI/BE”  gombbal kapcsolja ki a készüléket (11. ábra).

 A „P” gombot (4. ábra) legalább 6 másodperc hosszan tartsa nyomva.

Folyamatosan világít a „P” és a  szimbólum. Ezenkívül a gomb pillanatnyi funkciójának jelzésére a , a  és a  gomb felett világít a 3 kicsi szimbólum, lásd „Speciális üzemmód”, 255. oldal.

 Nyomja meg a lapozásra szolgáló „<” vagy „>” gombot (5. ábra) annyiszor, hogy az a jelzés világítson, amelynek statisztikáját meg kívánja jeleníteni.

-  az elkészített kávék száma
-  az elvégzett vízkömentesítések száma
-  az elkészített 4 csészés kannák száma
-  az elkészített 6 csészés kannák száma
-  az elkészített 8 csészés kannák száma
-  az elkészített 10 csészés kannák száma
-  a kiadott vízmennyiség literben mérve

Amikor világít egy jelzés, a hozzá tartozó szám a következőképpen jeleníthető meg:





 Nyomja meg és tartsa nyomva az „OK” gombot (5. ábra). Ekkor az egyes kijelzések egymás után villogni kezdenek, s ezzel megjelenítik a lekérdezett számot:

-  1 villanás  
1-nek felel meg
-  1 villanás  
10-nek felel meg
-  1 villanás  
100-nak felel meg
-  1 villanás  
1000-nek felel meg
-  1 villanás  
10 000-nek felel meg

A villogás mindaddig folyamatosan ismétlődik, amíg az „OK” gombot nyomva tartja. Minden ismétlés előtt 3 másodperc szünet van.

 Számolja meg az egyes jelzések számát.

Példa: A következő jelzőssor 1529-nek felel meg.

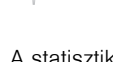
-  9 x villan
-  2 x villan
-  5 x villan
-  1 x villan
-  0 x villan

 A statisztika üzemmód elhagyásához a „P” gombot (4. ábra) legalább 6 másodperc hosszan tartsa nyomva.

## 18 Műszaki adatok

Hálózati feszültség: 220-240 V  
Teljesítményfelvétel: 1350 W

 Ez a készülék megfelel az EK alábbi irányelveinek:

- A kisfeszültségről szóló, a 93/68/EGK irányelvel módosított, 1973. 02. 19-i 73/23/EGK irányelv.
- Az elektromágneses összeférhetőségről szóló, a 92/31/EGK irányelvel módosított, 1989. 05. 03-i 89/336/EGK irányelv.

(H)

## 19 Ártalmatlanítás



### Csomagolóanyagok

A csomagolószhoz felhasznált anyagok nem károsítják a környezetet és újrahasznosíthatók. A műanyag részek meg vannak jelölve, pl. >PE<, >PS< stb. A csomagolóanyagokat jelölésüknek megfelelően ártalmatlanítsa a kommunális hulladékgyűjtő helyeken, az erre a célra szolgáló gyűjtőkonténerekben.



### Kiselejtezett készülék

A terméken vagy a csomagolásán

található  jelzés azt jelenti, hogy a termék nem kezelhető szokványos háztartási hulladékként, hanem az elektromos és az elektronikai készülékek újrahasznosítási gyűjtőhelyeinek egyikén kell leadni. E termék megfelelő ártalmatlanításával Ön védi a természetet és embertársainak egészségét. A helytelen hulladékkezelés veszélyt jelent a természetre és az egészségre. E termék újrahasznosításával kapcsolatos további információkért forduljon a helyi önkormányzathoz, a szemétszállítóhoz, vagy az üzlethez, amelyben a terméket megvásárolta.

## 20 Ha javításra van szükség

Feltétlenül őrizze meg az eredeti csomagolást, beleértve a habosított darabokat is. A szállítási károk elkerülése érdekében a készüléket biztonságosan be kell csomagolni.

A készülék beküldésekor mindig mellékelje a termoszkannát is. A készülék próbájához szükség van rá.



**RUS Уважаемые покупатели!**

Внимательно прочитайте это руководство по эксплуатации. Обязательно соблюдайте указания по технике безопасности! Храните руководство и, в случае продажи прибора, передайте его новому владельцу.

**Содержание**

<b>1 Пояснение к иллюстрации</b>	<b>274</b>	<b>11 Настройка тонкости помола</b>	<b>285</b>
1.1 Вид спереди (рис. 1)	274	<b>12 Настройка температуры кофе</b>	<b>286</b>
1.2 Вид спереди с открытой служебной дверцей (рис. 2)	274	<b>13 Чистка и уход</b>	<b>286</b>
1.3 Панель управления (рис. 3)	274	13.1 Регулярный уход	287
<b>2 Кофе и эспрессо</b>	<b>275</b>	13.2 Удаление кофейной гущи	287
<b>3 Указания по технике безопасности</b>	<b>275</b>	13.3 Чистка мельницы	287
<b>4 Специальный режим</b>	<b>277</b>	13.4 Чистка варочного блока	288
<b>5 Первый ввод в эксплуатацию</b>	<b>277</b>	13.5 Запуск программы удаления накипи	289
5.1 Установка и подключение прибора	277	<b>14 Как заказать оригинальные принадлежности</b>	<b>290</b>
5.2 Добавление воды	277	<b>15 Что делать, если на дисплее появится следующее сообщение...</b>	<b>290</b>
5.3 Помещение зерен в контейнер	278	<b>16 Проблемы, которые можно устранить перед тем, как позвонить в клиентскую службу</b>	<b>291</b>
5.4 Первое включение	278	<b>17 Режим статистики</b>	<b>293</b>
5.5 Включение прибора	278	<b>18 Технические характеристики</b>	<b>294</b>
5.6 Выключение прибора	279	<b>19 Утилизация</b>	<b>295</b>
5.7 Настройка жесткости воды	279	<b>20 Клиентская служба</b>	<b>295</b>
<b>6 Приготовление кофе из зерен</b>	<b>280</b>		
6.1 Советы по розливу горячего кофе	281		
<b>7 Приготовление нескольких чашек с помощью функции кувшина</b>	<b>282</b>		
<b>8 Приготовление молотого кофе</b>	<b>283</b>		
<b>9 Вспенивание молока</b>	<b>284</b>		
9.1 Прочистка паровой трубки	285		
<b>10 Подогрев воды</b>	<b>285</b>		

RUS

## 1 Пояснение к иллюстрации















### 1.1 Вид спереди (рис. 1)

- A** Сетка
- B** Термокувшин
- C** Главный выключатель (задняя сторона прибора)
- D** Регулируемая по высоте выпускная трубка
- E** Панель управления (см. рис. 3)
- F** Крышка контейнера для зерен
- G** Крышка воронки для кофе
- H** Подогреваемая площадка для чашек
- J** Шарнирная труба для пара и горячей воды
- K** Паровая трубка (съёмная)
- L** Внутренняя часть паровой трубки (съёмная)
- M** Кнопка для открывания служебной дверцы
- N** Емкость для воды с отметкой максимального уровня (съёмная)
- O** Поддон для сбора капель с поплавком (съёмный)

### 1.2 Вид спереди с открытой служебной дверцей (рис. 2)

- P** Служебная дверца (открыта)
- Q** Контейнер для кофейной гущи (съёмный)
- R** Откидная полка
- S** Варочный блок
- T** Ручка настройки тонкости помола
- U** Контейнер для зерен
- V** Мерная ложка
- W** Воронка для размолотого кофейного порошка
- X** Фирменная табличка (нижняя сторона прибора)
- Y** Жидкость для удаления накипи
- Z** Тестовая полоска

### 1.3 Панель управления (рис. 3)

- a** Регулятор «Крепость кофе / молотый кофе»
- b** Регулятор «Размер чашки»
- c** Дисплей
- d** Клавиша «1 чашка кофе»  В специальном режиме эта клавиша служит для перемещения по меню («<»)
- e** Клавиша «2 чашки кофе»  В специальном режиме эта клавиша служит для перемещения по меню («>»)
- f** Клавиша «Пар»  В специальном режиме эта клавиша служит для подтверждения пункта меню («ОК»)
- g** Клавиша «Р» В специальном режиме эта клавиша служит для подтверждения пункта меню („P”)
- h** Клавиша «вкл./выкл.» 
- j** Регулятор пара и горячей воды
- k** Клавиша «Кувшин кофе» 
- l** Символы «Молотый кофе»
- m** Символы «Кувшин»
- n** Символы «Крепость кофе»
- o** Символы «Размер чашки»
- p** Символ «Пустая емкость для воды» 
- q** Символ «Удаление накипи» 
- r** Символ «Температура прибора» 
- s** Символ «Служебная дверца открыта» 
- t** Символ «Контейнер для кофейной гущи» 
- u** Символ «Внимание» 
- v** Символ «Горячая вода» 
- w** Символ «Пар» 
- x** Символ «Приготовление 2 чашек» 
- y** Символ «Приготовление 1 чашки» 
- z** Символы для специального режима

## 2 Кофе и эспрессо

С помощью полностью автоматизированной кофеварки можно легко **приготовить** кофе, она проста в обслуживании и уходе.

Превосходный, неповторимый **вкус** благодаря

- специальной подготовке кофе: перед завариванием молотый кофе увлажняется, что делает напиток необыкновенно ароматным,
  - индивидуальной настройке количества воды в чашке от крошечного «эспрессо» до обильного кофе с пенкой,
  - настраиваемой температуре заваривания кофе,
  - возможности выбора между стандартным и крепким кофе,
  - настройке тонкости помола в зависимости от обжарки зерен,
  - и, не в последнюю очередь, — венчику пены, который так ценят истинные гурманы.
- Кроме того, для приготовления кофе «эспрессо» требуется значительно менее продолжительное взаимодействие воды с кофейным порошком, чем для традиционного кофе. По этой причине из порошка извлекается меньшее количество горьких веществ, а значит, готовый напиток легче усваивается организмом.

## 3 Указания по технике безопасности



Безопасность данного прибора отвечает существующим техническим и законодательным нормам. Несмотря на это, рекомендуется внимательно ознакомиться с представленными ниже указаниями по технике безопасности.

### Общие указания

- Напряжение, вид и частота тока в сети, к которой подключен прибор, должны соответствовать значениям, указанным на фирменной табличке в нижней части прибора.
- Питающий кабель не должен соприкасаться с горячими частями прибора.
- Не тяните за питающий кабель для извлечения вилки из розетки!
- Не используйте прибор, если:
  - поврежден питающий кабель;
  - имеются заметные повреждения на корпусе.
- Выключите прибор перед тем, как вставлять штекер в розетку.
- Этот прибор не предназначен для использования людьми (включая детей), которые по причине своей неопытности или неосведомленности не в состоянии безопасно им управлять, а также людьми (включая детей) с ограниченными физическими, сенсорными или умственными способностями. Исключением из данного правила являются случаи, когда такие люди получают инструкции по безопасной эксплуатации прибора от ответственного за них лица и первое время пользуются прибором под наблюдением этого лица.

### Безопасность детей

- **Не оставляйте включенный прибор без надзора и не подпускайте к нему детей!**

RUS

- Упаковочные материалы, например, полиэтиленовые пакеты, не должны попадать детям в руки.

#### **Указания по безопасной эксплуатации**

- **Внимание! Выпускная трубка, паровая трубка и площадка для чашек в процессе эксплуатации нагреваются. Не подпускайте близко детей!**
- **Внимание! Будьте осторожны, когда открыта паровая трубка! Попав на кожу, исходящий пар или пар может вызвать обваривание. Открывайте паровую трубку, только если под ней находится соответствующая емкость.**
- Не используйте пар для разогрева воспламеняющихся жидкостей!
- Перед включением прибора убедитесь, что в системе имеется вода! Нельзя заливать в емкость для воды ничего, кроме холодной воды, **например, молоко, горячую воду или другие жидкости.** Не наливайте больше 1,8 л воды.
- **Не используйте замороженных или карамелизированных кофейных зерен! Удалите из зерен все посторонние предметы, например, камешки. Блокировка или повреждение мельницы, вызванные наличием в ней посторонних предметов, может не подпадать под гарантийный случай.**
- В загрузочную воронку можно засыпать только молотый кофе.
- Выключайте прибор, когда он не используется.
- Не подвергайте прибор воздействию атмосферных явлений.
- В случае необходимости используйте стандартный удлинитель с диаметром провода не менее 1,5 мм<sup>2</sup>.
- Во избежание получения травмы люди с нарушением моторно-двигательных функций должны

пользоваться прибором только под присмотром.

- **Прибор должен использоваться только после установки контейнера для гуши, сетки и поддона для сбора капель!**

#### **Чистка и уход**

- Соблюдайте правила чистки и удаления накипи.
- Отключите прибор и вытащите штепсель перед проведением чистки или технического обслуживания.
- Не погружайте прибор в воду.
- Паровую трубку можно чистить только на отключенном, остывшем и не находящимся под давлением приборе!
- Не используйте для мойки прибора посудомоечную машину.
- **Попадание в мельницу воды может вызвать ее повреждение.**

Не открывайте и не пытайтесь отремонтировать прибор самостоятельно. Неправильно выполненный ремонт может послужить причиной травмирования пользователя.

Ремонт электроприборов должен производиться только подготовленным специалистом.



В случае необходимости выполнения ремонтных работ, включая замену питающего кабеля, обращайтесь



- к продавцу прибора или
- в клиентскую службу компании AEG/Electrolux.

**Кроме того, действие гарантии не распространяется на случаи неправильной эксплуатации прибора, использования его не по назначению, а также невыполнения программы удаления накипи немедленно после появления символа «☰», в соответствии с инструкциями, приведенными в данном руководстве. Блокировка или повреждение мельницы,**

**вызванные наличием в ней посторонних предметов, может не подпадать под гарантийный случай.**

## 4 Специальный режим

Для настройки жесткости воды («Настройка жесткости воды», стр. 279) и температуры кофе («Настройка температуры кофе», стр. 286), для пуска программы удаления накипи («Запуск программы удаления накипи», стр. 289) и для просмотра статистики («Режим статистики», стр. 293), нажмите на клавишу «Р» (рис. 4), чтобы перейти в специальный режим. В специальном режиме клавиши «1 чашка кофе» , «2 чашки кофе» , «Пар»  и «Р» используются для навигации. Соответствующая функция показана на дисплее над клавишей (рис. 5):

- «<» («1 чашка кофе» ) и «>» («2 чашки кофе» ) позволяют «листать» меню
- «ОК» («Пар» ) подтверждает пункт
- «Р» («Р») служит для возврата на последний уровень без внесения изменений.

## 5 Первый ввод в эксплуатацию

### 5.1 Установка и подключение прибора

Подберите горизонтальное, устойчивое, сухое, водостойкое и не подогреваемое основание для установки прибора.

- ⚠ Помните о необходимости свободной циркуляции воздуха вокруг прибора. Сбоку и сзади от прибора должен быть отступ не менее 5 см, над прибором – не менее 20 см.

Прибор нельзя устанавливать в помещениях, в которых температура может опускаться ниже 0 °С (прибор может повредиться в результате замерзания воды).



Внимание! Подождите около 2 часов перед тем, как включить прибор, если он транспортировался или хранился при низких температурах!

Чтобы предотвратить повреждение поверхности брызгами, установите прибор на подходящей подставке.



Подключите прибор к заземленной розетке. Не используйте незаземленные розетки.

### 5.2 Добавление воды

Перед включением прибора проверяйте наличие воды в емкости и доливайте ее при необходимости. Прибор автоматически промывается водой при каждом включении и выключении.



Вытащите емкость для воды из прибора (рис. 6). Перед тем как вынуть емкость для воды, переместите паровую трубку в середину прибора, иначе вынуть емкость не удастся.



Наполните емкость свежей холодной водой. Уровень воды не должен превышать отметку MAX.



В емкость нельзя наливать другие жидкости, кроме холодной воды (например, минеральную воду или молоко).



Вставьте емкость для воды обратно (рис. 6). Нажмите на емкость для воды, чтобы открылся вентиль.



Чтобы кофе всегда был ароматным и вкусным,

- ежедневно меняйте воду в емкости и
- как минимум раз в неделю мойте емкость свежей, проточной водой (но не в посудомоечной машине). После этого ополосните емкость свежей водой.

RUS

### 5.3 Помещение зерен в контейнер

- Откройте крышку контейнера для зерен и наполните его свежими кофейными зёрнами (рис. 7). Затем закройте крышку.

**Внимание!** Не используйте замороженных или карамелизированных кофейных зёрен! В прибор должны засыпаться только жареные зёрна. Убедитесь, что в контейнер не попали посторонние предметы, например, камешки. **Блокировка или повреждение мельницы, вызванные наличием в ней посторонних предметов, может не подпадать под гарантийный случай.**

- Предприятием-изготовителем устанавливается средняя тонкость помола. При необходимости эту установку можно изменить. Инструкции по установке требуемой тонкости помола см. в разделе «Настройка тонкости помола», стр. 285.

**Тонкость помола можно изменять только в процессе размола. Изменение установок при выключенной мельнице может привести к повреждению прибора.**

- Кофеварка была проверена на заводе. Для этого использовался кофе, поэтому в мельнице может оставаться немного кофе. Существует абсолютная гарантия того, что эта кофеварка новая.

### 5.4 Первое включение

При первом вводе прибора в эксплуатацию необходимо произвести удаление воздуха из кофеварки.

- Включите прибор с помощью главного выключателя, расположенного на задней стороне (рис. 8). При первом включении главного выключателя, все символы на

дисплее загорятся на пару секунд для теста самоконтроля, затем будут мигать символы ☰ и △.

- О заправке емкости для воды см. «Добавление воды», стр. 277.
- Вставьте емкость для воды обратно (рис. 6). Нажмите на емкость для воды, чтобы открылся вентиль.
- Поверните паровую трубку наружу и поставьте под нее чашку (рис. 9).
- Поверните регулятор пара и горячей воды до упора против часовой стрелки в положение ☰ (рис. 10). Из паровой трубки вытечет некоторое количество воды. Символы ☰ и △ горят непрерывно.

Когда чашка наполнится приблизительно 30 мл воды, начнут мигать символы ☰ и △.

- Поверните регулятор пара и горячей воды до упора по часовой стрелке в положение ● (рис. 10), чтобы выключить сток воды. Символ ↓ мигает несколько секунд, и прибор отключится.
- Засыпьте кофейные зёрна в контейнер для зерен, см. «Помещение зерен в контейнер», стр. 278.

### 5.5 Включение прибора

Перед включением прибора проверяйте наличие воды в емкости и доливайте ее при необходимости. Прибор автоматически промывается водой при каждом включении и выключении.

- Включите прибор, нажав клавишу «вкл./выкл.» Ⓛ (рис. 11).
- После включения происходит автоматическая настройка прибора. Об этом свидетельствует несколько повышенный уровень шума.



- Во время разогрева (около 120 секунд) мигает символ ↓. Во время разогрева прибор проводит автоматическое ополаскивание (немного горячей

воды вытечет из выпускной трубы и попадет в поддон для сбора капель).

После завершения нагревания символ  будет гореть непрерывно.

Прибор готов к эксплуатации. На дисплее горят символы режима, который был выбран последним пользователем.

## 5.6 Выключение прибора

 Выключите прибор, нажав клавишу «вкл./выкл.»  (рис. 11).

Символ  мигает. Прибор выполнит ополаскивание и выключится.

 Для экономии электроэнергии прибор, который длительное время не используется, автоматически отключается через 3 часа.

 Если прибор не будет использоваться длительное время, то после выключения с помощью клавиши «вкл./выкл.» выключите дополнительно главный выключатель на задней стенке прибора (рис. 8).

## 5.7 Настройка жесткости воды

После первого ввода прибора в эксплуатацию, а также в случае применения воды из другого источника на приборе необходимо настроить жесткость воды. Для определения жесткости воспользуйтесь прилагаемым тестером или обратитесь к поставщику воды.

### Определение жесткости воды

 Примерно на 1 секунду погрузите тестовую полоску в холодную воду. Стряхните лишнюю воду. Уровень жесткости определяется по количеству розовых полосок.

 **Нет или одна розовая полоска: уровень жесткости 1 (мягкая вода)**  
до 1,24 ммол/л, или до 7° немецкой меры жесткости, или до 12,6° французской меры жесткости



**Две розовых полоски: уровень жесткости 2 (вода средней жесткости)**  
до 2,5 ммол/л, или до 14° немецкой меры жесткости, или до 25,2° французской меры жесткости

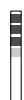

**Три розовых полоски: уровень жесткости 3 (жесткая вода)**  
до 3,7 ммол/л, или до 21° немецкой меры жесткости, или до 37,8° французской меры жесткости







**Четыре розовых полоски: уровень жесткости 4 (очень жесткая вода)**  
более 3,7 ммол/л, или более 21° немецкой меры жесткости, или более 37,8° французской меры жесткости

### Настройка и сохранение уровня жесткости воды

Можно настроить любой из четырех уровней жесткости. Предприятием-изготовителем стандартно устанавливается значение 4.

 Нажмите на включенном приборе клавишу «Р» (рис. 4).

Загорятся символы «Р» и . Кроме того, загорятся 3 малых символа над клавишами ,  и  для отображения актуальной функции этих клавиш, см. «Специальный режим», стр. 277.

 Для подтверждения выбора нажмите клавишу «OK» (рис. 5).

На дисплее будут показаны актуальные настройки. Уровень жесткости отображается следующим образом:

 Уровень 1

 Уровень 2

 Уровень 3

 Уровень 4

 Затем нажимайте клавиши «<» или «>» (рис. 5), пока не появится нужный уровень жесткости воды.

 Для подтверждения выбора нажмите клавишу «OK» (рис. 5). Теперь этот уровень сохранен в памяти прибора.

RUS

-  Для прерывания настройки без сохранения введенных параметров необходимо нажать «Р» вместо «ОК».

Если клавиша «ОК» не нажата, то приблизительно через 120 секунд прибор автоматически вернется в режим приготовления кофе без сохранения введенных данных.

-  Чтобы вернуться в режим приготовления кофе, нажмите клавишу «Р» (рис. 4) или подождите около 120 секунд, пока возврат не будет выполнен автоматически.

## 6 Приготовление кофе из зерен

Если кофе готовится из зерен, автоматически выполняются следующие действия: размалывание, разделение на порции, прессование, подготовка, заваривание и выброс кофейной гущи.





Прибор можно настроить в соответствии с личными предпочтениями в отношении тонкости помола и количества кофейного порошка на одну чашку.

-  Не используйте замороженных или карамелизированных кофейных зерен! В прибор должны засыпаться только жареные зерна. Убедитесь, что в контейнер не попали посторонние предметы, например, камешки. **Блокировка или повреждение мельницы, вызванные наличием в ней посторонних предметов, может не подпадать под гарантийный случай.**

Выберите «эспрессо» краткого приготовления или кофе с пенкой длинного приготовления.

-  Выберите нужный размер чашки с помощью регулятора «Размер чашки» (рис. 12). Будет показан выбранный размер чашки.





-  Размер чашки отображается следующим образом:

	Чашка «Эспрессо»
	маленькая чашка
	средняя чашка
	большая чашка
	кружка







Можно выбрать кофе с очень мягким, мягким, обычным, сильным или очень сильным вкусом.

-  Выберите нужную крепость кофе с помощью регулятора «Крепость кофе» (рис. 13). Будет показана выбранная крепость кофе.



-  Крепость кофе отображается следующим образом:



	очень мягкий
	мягкий
	обычный
	крепкий
	очень крепкий



-  Поставьте под выпускными трубками одну или две чашки (рис. 14). Чтобы уменьшить потерю тепла и предотвратить разбрызгивание кофе, отрегулируйте длину трубки в соответствии с высотой чашки (рис. 15).

-  Нажмите клавишу «1 чашка кофе»  для приготовления одной чашки кофе или клавишу «2 чашки»  для приготовления двух чашек кофе. Символ «1 чашка»  или «2 чашки»  горит. Прибор начнет размалывать зерна. Сначала кофейный порошок смачивается небольшим количеством воды. После небольшой паузы начинается непосредственное заваривание кофе. Кофе выливается в чашку. После того, как поступит требуемое количество кофе, прибор автоматически завершит выдачу кофе и отбросит использованный кофейный порошок в контейнер для кофейной гущи. Все это время горит символ «1 чашка»  или «2 чашки» .





☞ Выдачу кофе можно досрочно прервать в любой момент, для этого нужно повторно нажать уже нажатую клавишу «1 чашка»  или «2 чашки»  или повернуть регулятор «Размер чашки» (рис. 12) против часовой стрелки в направлении «Чашка эспрессо».

☞ После завершения выдачи кофе можно увеличить количество кофе, нажав и удерживая клавишу «1 чашка»  или «2 чашки» , пока не будет получено нужное количество, или повернув регулятор «Размер чашки» (рис. 12) по часовой стрелке в направлении «Кружка» (это необходимо выполнить непосредственно после выдачи кофе и до сброса использованного кофейного порошка в контейнер для кофейной гущи).

Через пару секунд, когда символ «1 чашка»  или «2 чашки»  погаснет, прибор будет снова готов к эксплуатации, и можно будет готовить следующую порцию кофе.

**i** Если кофе вытекает каплями или не полностью или вытекает слишком быстро и пенка образуется не так, как Вам хочется, то необходимо изменить настройку тонкости помола, см. «Настройка тонкости помола», стр. 285

**i** Если символы  и  мигают, кофе слишком мелко помолот. Необходимо изменить тонкость помола, см. «Настройка тонкости помола», стр. 285.

**i** Если на дисплее горит символ , то необходимо заполнить емкость для воды, поскольку иначе прибор не сможет приготовить кофе. (Когда этот символ загорится, в емкости для воды может оставаться еще немного воды.)

**i** Если горит символ , контейнер для кофейной гущи полон и требует опорожнения и очистки, см. «Удаление кофейной гущи», стр. 287. Пока контейнер для кофейной гущи не будет очищен, символ будет гореть, и кофеварка не сможет приготовить кофе.

**i** Не вынимайте емкость для воды в процессе выдачи кофе. Если она вынута, кофеварка не сможет больше приготовить кофе. Для выпуска воздуха из кофеварки поверните регулятор пара и горячей воды до упора против часовой стрелки в положение  и дайте воде несколько секунд протечь через паровую трубку.

**i** При первом пуске в эксплуатацию кофеварки необходимо приготовить 4-5 чашек кофе, только после этого прибор начнет давать удовлетворительный результат.

## 6.1 Советы по розливу горячего кофе:

- Если сразу же после включения кофейной машины приготовить маленькую чашку кофе (меньше 60 мл), используйте горячую воду операции промывки для предварительного разогрева чашек.
- Установите в соответствующем меню более высокую температуру, см. «Настройка температуры кофе», стр. 286.
- Не используйте очень толстые чашки, если только они не подогреты, поскольку они слишком быстро поглощают тепло.
- Используйте только подогретье чашки, для этого их нужно ополоснуть теплой водой или поставить как минимум на 20 минут на подогреваемую площадку для чашек (Н) включенной кофеварки.

RUS





## 7 Приготовление нескольких чашек с помощью функции кувшина

С помощью этой функции можно автоматически **приготовить несколько чашек кофе непосредственно во входящий в комплект термокувшин из нержавеющей стали**: размалывание, разделение на порции, прессование, подготовка, заваривание и выброс кофейной гущи происходят так же, как описано в предыдущем разделе.

- ☞ Поверните крышку входящего в комплект кувшина из нержавеющей стали (рис. 16) и снимите крышку. Ополосните кувшин и крышку.
- ☞ Поверните крышку на кувшине в положение высыпания (рис. 17) и поставьте его под выпускную трубу (D). Чтобы вставить кувшин, выпускную трубу нужно полностью поднять вверх.

Один из символов функции кувшина горит, в зависимости от того, сколько чашек были выбраны при последнем использовании этой функции. Кроме того, горят символы перемещения «<<» и «>>».

Количество чашек, выданных в кувшин, отображаются следующим образом:

-  4 чашки
-  6 ашки
-  8 ашки
-  10 ашки

- ☞ Убедитесь в том, что емкость для воды полна, что в контейнере достаточно зерен и что контейнер для кофейной гущи пуст, чтобы можно было приготовить несколько порций кофе для кувшина.

**i** Если требуется изменить крепость кофе и объем для функции кувшина, используйте регулятор «Размер чашки» (рис. 12) или регулятор «Крепость кофе» (рис. 13), как описывается в разделе «Приготовление кофе из зерен», стр. 280.

☞ При необходимости установите с помощью клавиш «<<» или «>>» символ, соответствующий количеству чашек, которое необходимо залить в кувшин, например,  для 8 чашек.

☞ Нажмите клавишу «Кувшин»  (рис. 18).



Во время приготовления кофе мигает символ кувшина для выбранного количества чашек.

По окончании процесса заваривания кофе, все символы кувшина мигают попеременно, при чем символ для выбранного количества чашек горит в два раза дольше.

☞ Теперь нужно вынуть термокувшин и закрыть крышку (рис. 19), чтобы кофе долгое время оставался теплым.

Прибор автоматически возвратится в режим приготовления кофе.







**i** Если засыпано слишком мало кофе в зернах или в емкости недостаточно воды для завершения указанной процедуры, или контейнер для кофейной гущи заполнен, прибор прервет процесс и текущую программу. После устранения причины прерывания программу необходимо запустить повторно. При этом следует учесть уже находящееся в кувшине количество кофе, чтобы кувшин не переполнился.

**i** Если символы  и  мигают, кофе слишком мелко помолот. Необходимо изменить тонкость помола, см. «Настройка тонкости помола», стр. 285.



## 8 Приготовление молотого кофе

Эта функция предназначена для приготовления молотого кофе, например, без содержания кофеина.

 **Внимание!** Убедитесь, что порошок не остается на стенках воронки и не содержит посторонних предметов. Воронка не предназначена для хранения кофе, порошок должен попадать непосредственно в варочный блок.

 Поверните регулятор «Крепость кофе / молотый кофе» (рис. 20) в нужное положение  (для 1 чашки) или  (для 2 чашек), чтобы выбрать функцию для молотого кофе. В результате кофемолка будет отключена. Горит символ  (для 1 чашки) или оба символа   (для 2 чашек).

 Откройте крышку воронки для кофе и засыпьте свежий кофейный порошок (рис. 21).

Обязательно пользуйтесь входящей в состав мерной ложкой. Не засыпайте больше 2 мерных ложечек без горки, иначе прибор не сможет приготовить кофе, или кофейный порошок рассыплется по прибору и испачкает его, или кофе будет течь отдельными каплями, и загорятся символы  и .

В процессе заваривания кофе добавлять порошок нельзя. Дождитесь окончания заваривания и засыпьте порошок для следующей чашки. Никогда не засыпайте кофейный порошок в выключенную кофеварку, т.к. при этом он размажется внутри прибора.



 Используйте только кофейный порошок для полностью автоматических кофеварок. Не засыпайте в воронку кофейные зерна, растворимые, высушенные вымораживанием порошки и другие аналогичные продукты. Слишком мелкий

порошок может привести к засорению машины.









 Если воронка для размолотого кофейного порошка засорилась (по причине повышенной влажности в приборе или из-за того, что было засыпано больше 2 мерных ложек кофейного порошка), протолкните застрявший порошок ножом или черенком ложки (рис. 22). Затем выньте варочный блок и очистите его вместе с кофеваркой как описано в «Чистка варочного блока», стр. 288.

 Закройте крышку.

 Выберите нужный размер чашки с помощью регулятора «Размер чашки» (рис. 12), как описано в разделе «Приготовление кофе из зерен», стр. 280.

 Нажмите клавишу «1 чашка кофе»  для приготовления одной чашки кофе или клавишу «2 чашки»  для приготовления двух чашек кофе.

Начинается приготовление кофе.

 Если была выбрана функция для молотого кофе для 1 чашки, а порошок в воронку для кофе не насыпан, после нажатия клавиши  начнут мигать символы  и . Если была выбрана функция для молотого кофе для 2 чашек, а порошок в воронку для кофе не насыпан, после нажатия клавиши  начнут мигать символы   и .

 Чтобы вернуться после приготовления кофе в режим приготовления кофе из зерен, поверните регулятор «Крепость кофе / молотый кофе» (рис. 20) на произвольную крепость кофе (снова появится возможность включения кофемолки).



RUS

## 9 Вспенивание молока

Пар может быть использован для вспенивания молока и нагрева жидкостей. Для генерации пара прибор запускается в специальном режиме, поскольку для этого требуется более высокая температура, чем для приготовления кофе.



-  Рецепт приготовления кофе «капучино»: на 1/2–1/3 наполните большую чашку кофе «эспрессо» и добавьте вспененное молоко.

-  **Внимание!** Будьте осторожны, когда открыта паровая трубка! Попав на кожу, исходящий кипяток или пар может вызвать обваривание. Открывайте паровую трубку, только когда она погружена в молоко.

-  Чтобы начать генерирование пара, нажмите клавишу «Пар» (рис. 23). Загорится символ  и прибор начнет нагрев. Во время нагрева мигает символ .

После завершения нагревания символ  будет гореть непрерывно. Прибор готов к вспениванию молока.

-  Если функция генерирования пара не используется больше 2 минут, прибор автоматически переключается в режим приготовления кофе.

-  Чтобы при вспенивании остатки воды не смешались с молоком, воду необходимо предварительно слить. Для этого поместите сосуд под паровой трубкой и установите регулятор пара и горячей воды (рис. 10) в положение , пока не начнет выходить пар. Поверните регулятор назад в положение .



-  Налейте нежирное холодное молоко в узкую кружку, которая помещается под паровой трубкой.

-  Молоко необходимо хорошо охладить. Кроме того, пользуйтесь холодной посудой (лучше всего –

кружкой из нержавеющей стали) и не ополаскивайте ее теплой водой.



-  Вытащите трубку и поместите кружку таким образом, чтобы отверстие паровой трубки погрузилось в молоко (рис. 24).

-  **Внимание!** При высыхании молока происходит засорение паровой трубки. Не погружайте паровую трубку в молоко насколько глубоко, чтобы оно покрывало отверстие воздухозаборника в верхней части паровой трубки. При этом молоко может засосаться в паровую трубку, и вызвать ее засорение.

-  Поверните регулятор пара и горячей воды (рис. 10) в положение . Начнется вспенивание молока.

-  Для получения густой пенки медленно покачайте кружку снизу вверх. Дождитесь, пока молоко увеличится в объеме минимум вдвое.



-  Не рекомендуется пользоваться паром больше 2 минут без перерыва.

-  Чтобы закончить вспенивание, поверните регулятор пара и горячей воды (рис. 10) в положение  и вытащите кружку.

-  **Внимание!** Попадание горячих брызг молока на кожу может вызвать обваривание! Перед извлечением кружки обязательно отключите пар.



-  Чтобы выйти из режима генерирования пара, нажмите клавишу «Пар» (рис. 23) или подождите примерно 120 секунд, пока прибор автоматически не переключится в режим приготовления кофе.

Прибор готов к приготовлению кофе.

-  После вспенивания молока поверните регулятор пара и горячей воды (рис. 10) на короткое время в положение , чтобы промыть паровую трубку горячей водой.









Это позволяет предотвратить засорение трубки засохшими частицами

молока. Подставьте емкость для улавливания вытекающей воды. Всё это время горит символ .

-  Снова поверните регулятор пара и горячей воды в положение . На дисплее отображаются последние выбранные настройки.

### 9.1 Прочистка паровой трубки

**Внимание!** Из гигиенических соображений рекомендуется проводить описанную ниже процедуру каждый раз после вспенивания молока. Это предотвратит оседание молока внутри паровой трубки.





-  Поверните регулятор пара и горячей воды по часовой стрелке до упора в положение . Подождите пару минут, пока остынет паровая трубка.
-  Затем возьмите шарнирную трубу за зажим черного цвета и откройте байонетное соединение паровой трубки, слегка повернув по часовой стрелке. Вытащите паровую трубку вниз (рис. 25).
-  Вытащите внутреннюю часть паровой трубки вниз из шарнирной трубы.
-  Промойте паровую трубку и внутреннюю часть теплой водой.
-  Проверьте, что оба отверстия, отмеченные на рис. 26, не забиты. При необходимости проткните их иглой и прочистите.
-  Снова установите нижнюю часть, аккуратно насадив ее на шарнирную трубу.
-  Снова установите паровую трубку, для этого отодвиньте ее и поверните против часовой стрелки.

## 10 Подогрев воды

Горячая вода используется для подогрева чашек и приготовления горячих напитков, например, чая или бульона.





Внимание! Будьте осторожны, когда открыта трубка горячей воды! Попав на кожу, кипяток может вызвать обваривание. Открывайте трубку, только когда под ней находится соответствующая емкость.

-  Поместите емкость под трубкой.
-  Поверните регулятор пара и горячей воды в положение  (рис. 10). Начинается подача горячей воды; горит символ .



Не рекомендуется сливать горячую воду больше 2 минут без перерыва.

-  После наливания горячей воды поверните регулятор пара и горячей воды в положение  (рис. 10) и вытащите емкость.

## 11 Настройка тонкости помола

Предприятием-изготовителем устанавливается средняя тонкость помола. Если кофе выливается слишком быстро или слишком медленно (каплями), то в процессе размола необходимо изменить степень помола.



**Изменение тонкости помола допускается только в процессе помола, т.е. кнопку для настройки тонкости помола (рис. 2, T и рис. 27) можно поворачивать лишь до тех пор, пока мельница мелет зерна кофе во время приготовления кофе. Изменение установок при выключенной мельнице может привести к повреждению прибора.**

-  В процессе измельчения зерен настройте тонкость помола с помо-

RUS

шью ручки настройки тонкости помола (рис. 2, Т) и (рис. 27).

- Если кофе вытекает отдельными каплями или совсем не вытекает (возможно, мигают символы ☕ и ⚙), то регулятор нужно повернуть на одно деление по часовой стрелке. Поворачивайте регулятор на одно деление, пока не будет достигнут удовлетворительный результат.
- Если кофе вытекает слишком быстро и пенка образуется не так, как Вам хочется, поверните регулятор на одно деление против часовой стрелки.

**i** Не поворачивайте ручку настройки тонкости помола слишком сильно, т.к. иначе кофе для второй чашки может литься медленно (капать).

**i** Результат изменения настроек будет виден только после двух следующих приготовлений кофе.

#### **Удаление посторонних предметов из мельницы**

Попадание посторонних предметов (например, мелких камешков) может привести к повреждению мельницы. Посторонний предмет в кофе вызывает равномерный громкий звук. Услышав этот звук, немедленно выключите прибор и обратитесь в клиентскую службу.

**Блокировка или повреждение мельницы, вызванные наличием в ней посторонних предметов, может не подпадать под гарантийный случай.**

## 12 Настройка температуры кофе

Можно выбрать один из 3 температурных режимов. Предприятием-изготовителем настраивается значение «Температура высокая». Ее можно изменить следующим образом:

**☞** Нажмите клавишу «Р» (рис. 4). Загорятся символы «Р» и ☕. Кроме того, загорятся 3 малых символа над клавишами ☕, ☕ и ☕ для отображения актуальной функции этих клавиш, см. «Специальный режим», стр. 277

**☞** Нажимайте клавиши «<» или «>» (рис. 5), пока не загорится символ ↓.

**☞** Для подтверждения выбора нажмите клавишу «ОК» (рис. 5). На дисплее будут показаны актуальные настройки. Температура отображается следующим образом:

☕ Температура низкая  
☕☕ Температура средняя  
☕☕☕ Температура высокая

**☞** С помощью клавиш «<» или «>» (рис. 5) выберите требуемый температурный режим.

**☞** Когда будет показана нужная температура, подтвердите выбор, нажав клавишу «ОК» (рис. 5). Настроенная температура сохраняется в памяти прибора.

**i** Для прерывания настройки без сохранения введенных параметров необходимо нажать «Р» вместо «ОК».











**i** Если клавиша «ОК» не нажата, то приблизительно через 120 секунд прибор автоматически вернется в режим приготовления кофе без сохранения введенных данных.

**☞** Чтобы вернуться в режим приготовления кофе, нажмите клавишу «Р» (рис. 4) или подождите около 120 секунд, пока возврат не будет выполнен автоматически.

## 13 Чистка и уход





Регулярная чистка позволяет обеспечить бесперебойное функционирование прибора и высокое качество приготавливаемого кофе.



### 13.1 Регулярный уход

-  **Внимание!** Перед началом чистки прибор необходимо выключить. Подождите, пока он остынет.
-  **Внимание!** Прибор или отдельные его части нельзя мыть с помощью посудомоечной машины. Прибор нельзя погружать в воду.
-  **Внимание!** Попадание воды в контейнер для зерен может вызвать повреждение мельницы.
-  Не используйте для чистки абразивные и едкие средства. Внутри и снаружи корпус необходимо протереть влажным полотенцем.
-  Ежедневно снимайте емкость для воды (рис. 6) и выливайте из нее остатки воды. Сполосните емкость проточной водой. Используйте для приготовления кофе только свежую воду.
-  Содержимое контейнера для кофейной гущи следует удалять каждый день или сразу же после того, как появится соответствующее сообщение на дисплее, см. «Удаление кофейной гущи», стр. 287.
-  Регулярно выливайте жидкость из поддона для сбора капель. Жидкость также необходимо слить, если через сетку виден красный поплавок поддона для сбора капель (рис. 28).
-  Регулярно (не менее одного раза в неделю) необходимо мыть теплой водой, мягким моющим средством и щеткой емкость для воды (N), поддон для сбора капель (O), сетку (A) и контейнер для кофейной гущи (Q).
-  После каждого вспенивания снимайте паровую трубку и тщательно удалите остатки молока, см. «Прочистка паровой трубки», стр. 285.
-  Следите за тем, чтобы не забивалось отверстие выпускной трубки. Засохший кофе можно счистить иголкой (рис. 29).

### 13.2 Удаление кофейной гущи

После приготовления 14 одинарных (или 7 парных порций кофе) загорится символ , указывающий на то, что контейнер полон, и его необходимо очистить. Пока контейнер для кофейной гущи не будет очищен, машина не сможет приготовить кофе.

-  Разблокируйте служебную дверцу нажатием на соответствующую кнопку для открывания и откройте ее (рис. 30), загорится символ .
  -  Выньте и очистите поддон для сбора капель (рис. 31).
  -  Вылейте содержимое контейнера для кофейной гущи и тщательно очистите его. Следите за тем, чтобы были удалены все остатки, находящиеся на днище.
- Внимание!** Каждый раз, вынимая поддон для сбора капель **необходимо** также выбросить содержимое контейнера для кофейной гущи, даже если он не совсем полон. Если не выполнить эту операцию, то при следующем приготовлении кофе контейнер для кофейной гущи может переполниться, и лишняя гуща забьет кофеварку.

 После извлечения поддона для сбора капель символ  начнет мигать.

 Если прибор активно используется, контейнер для кофейной гущи следует чистить ежедневно. Контейнер для кофейной гущи можно вынимать только из включенного прибора. Только в этом случае прибор может определить, что он вынут.

### 13.3 Чистка мельницы

Остатки кофейного порошка из контейнера для зерен можно удалить мягкой щеточкой или пылесосом.

-  **Внимание!** Попадание в мельницу воды может вызвать ее повреждение.

RUS

☞ Выключите прибор с помощью клавиши «вкл./выкл.» (рис. 11) и главного выключателя (рис. 8). Отключите прибор от сети электропитания.

☞ Извлеките оставшиеся зерна (например, с помощью пылесоса со специальной насадкой).

**i** Если не удастся удалить посторонний предмет, обратитесь в клиентскую службу. **Блокировка или повреждение мельницы, вызванные наличием в ней посторонних предметов, может не подпадать под гарантийный случай.**

**!** **Внимание!** Контакт с работающей мельницей может привести к получению травмы. Не включайте прибор в процессе чистки мельницы. Это может послужить причиной получения тяжелых увечий. Обязательно отключите прибор от сети электропитания.

☞ Чтобы проверить работу мельницы, запустите процесс приготовления кофе с небольшим количеством зерен. При первом запуске мельницы в варочный блок попадает меньше порошка, поскольку часть его остается в канале. Это может повлиять на вкусовые характеристики первой чашки кофе.

### 13.4 Чистка варочного блока

Варочный блок рекомендуется чистить регулярно, в зависимости от интенсивности использования прибора. Если не предполагается использовать прибор на протяжении длительного периода времени (например, на время отпуска), необходимо произвести тщательную чистку прибора, включая варочный блок, емкость для воды и контейнер для кофейной гущи. Для этого выполните следующие действия:

☞ Нажав клавишу «вкл./выкл.» (рис. 11), выключите прибор (не вынимайте сетевой штекер) и подождите, пока погаснут все символы!

☞ Разблокируйте служебную дверцу нажатием на соответствующую кнопку для открывания и откройте ее (рис. 30).

☞ Выньте и очистите поддон для сбора капель и контейнер для кофейной гущи (рис. 31).

☞ Нажмите на обе боковые красные клавиши разблокирования варочного блока и на середину блока (рис. 32) и достаньте варочный блок.

**i** **Внимание!** Варочный блок можно достать только, если прибор отключен с помощью клавиши «вкл./выкл.» **1** на передней части прибора. Прибор нельзя отключать от сети. Попытка вынуть варочный блок при включенной кофеварке может привести к повреждению прибора.

☞ Промойте варочный блок под проточной водой, не используя моющие средства. **Не используйте для мойки варочного блока посудомоечную машину.**

☞ Тщательно очистите внутреннюю часть прибора. Счистите засохший кофе с помощью деревянной или пластиковой вилки или аналогичного инструмента, не царапающего поверхность (рис. 33), затем удалите все остатки с помощью пылесоса (рис. 34).

☞ Для последующего применения вставьте варочный блок (рис. 36, a) в крепление (рис. 36, b) и задвиньте штифт (рис. 36, c). Штифт должен войти в трубу (рис. 36, d) в нижней части варочного блока.

☞ Теперь сильно нажмите на надпись PUSH (рис. 36, e), чтобы варочный блок встал на место с щелчком.





 Услышав щелчок, убедитесь в том, что красные клавиши (рис. 36, f) встали на место, в противном случае не удастся закрыть служебную дверцу.

Рис. 37: Обе красные клавиши вышли правильно.

Рис. 38: Красные клавиши не вышли.

 Вставьте поддон для сбора капель и контейнер для кофейной гущи в прибор.

 Закройте служебную дверцу.

 Если варочный блок вставлен неправильно, т.е. при вставке не было слышно щелчка, а красные клавиши вышли неправильно, то служебная дверца не закроется.

 Если варочный блок вставляется с трудом, то его (перед вставкой) нужно привести к нужной высоте, для этого одновременно нажмите на блок снизу и сверху, как показано на рис. 35.

 Если варочный блок и после этого вставляется с трудом, закройте служебную дверцу, выньте штекер питающего кабеля из розетки и снова вставьте его в розетку. Подождите, пока погаснут все символы, затем откройте служебную дверцу и снова вставьте варочный блок.

### 13.5 Запуск программы удаления накипи





Выполнение программы удаления накипи позволяет полностью удалить образовавшуюся внутри прибора накипь. Если загорелся символ , то необходимо удалить накипь.



 **Внимание!** Пользуйтесь только рекомендованными AEG/Electrolux средствами для удаления накипи. При использовании других средств AEG/Electrolux не несет ответственности за возможный ущерб. Средства для удаления накипи можно заказать в специализированных ма-



газинах или в клиентской службе AEG/Electrolux.



 Процесс удаления накипи (длительность около 45 минут) прерывать нельзя. В случае перебоев с электричеством программу необходимо запустить повторно.

 Перед запуском программы удаления накипи необходимо помыть варочный блок (см. раздел «Чистка варочного блока», стр. 288).

 Нажмите клавишу «P» (рис. 4). Загорятся символы «P» и . Кроме того, загорятся 3 малых символа над клавишами ,  и  для отображения актуальной функции этих клавиш, см. «Специальный режим», стр. 277

 Нажимайте клавиши «<» или «>» (рис. 5), пока не загорится символ .





 Для подтверждения нажмите клавишу «OK» (рис. 5). Символы  и  мигают, а «P» горит непрерывно.

 Чтобы прервать программу удаления накипи на этом месте, выключите прибор, нажав клавишу «вкл./выкл.»  (рис. 11).

 Слейте воду из емкости, залейте не менее 1 литра воды и добавьте средство для удаления накипи.

 **Внимание!** Следите за тем, чтобы брызги средства для удаления накипи не попадали на восприимчивые к кислоте поверхности, например, на мрамор, известняк или керамику.

 Поставьте под паровую трубку сосуд объемом не менее 1,5 литра (рис. 9).

 Поверните регулятор пара и горячей воды в положение . Запустится программа удаления накипи и средство для удаления накипи вытечет из паровой трубки. Символы ,  и «P» горят непрерывно.

RUS

Программа удаления накипи автоматически выполнит несколько промываний, разделенных паузой, чтобы удалить известковые отложения внутри кофеварки.

Примерно через 30 минут емкость для воды опустеет, символы ☕ и ⚠ начнут мигать, а «P» будет гореть непрерывно.

- ☞ Верните регулятор пара и горячей воды в положение ●.

Прибор готов к промыванию свежей водой.

- ☞ Вытащите емкость для воды, наполните ее свежей водой и вставьте назад.

- ☞ Слейте воду из емкости под паровой трубкой и опять подставьте ее под трубку.

- ☞ Поверните регулятор пара и горячей воды в положение ☕.

Будет выполнено ополаскивание свежей водой, использованная вода вытечет из паровой трубки. Символы ☕, ⚠ и «P» горят непрерывно.

Через несколько минут емкость для воды опустеет, символы ☕ и ⚠ начнут мигать, а «P» будет гореть непрерывно.

- ☞ Верните регулятор пара и горячей воды в положение ●.

Символы будут отображаться в соответствии с режимом приготовления кофе, который был выбран последним пользователем, а символ ☕ будет гореть непрерывно.

- ☞ Вылейте воду из емкости.

- ☞ Вытащите емкость для воды, наполните ее свежей водой и вставьте назад.

Прибор готов к использованию и находится в режиме приготовления кофе, который был настроен последним.

- 📘 Мы рекомендуем вылить первую чашку кофе, заваренную после вы-

полнения программы удаления накипи.

## 14 Как заказать оригинальные принадлежности

Чтобы прибор прослужил долго и без поломок, его необходимо регулярно чистить и удалять накипь.

Оригинальные средства для удаления накипи можно заказать непосредственно у нас.

Для этого звоните по телефону горячей линии (на территории Германии): 1801 - 20 30 60\*

(\*из стационарной телефонной сети Deutsche Telekom) с понедельника по пятницу с 8.00 до 18.00

## 15 Что делать, если на дисплее появится следующее сообщение...

### Символ ☕ горит непрерывно

- Емкость для воды пуста или неправильно установлена.

- ☞ Заполните емкость для воды и вставьте ее в соответствии с инструкцией, см. «Добавление воды», стр. 277.

- Емкость для воды загрязнена, или в ней образовались известковые отложения.

- ☞ Промойте емкость для воды или удалите накипь.

### Символы ☕ и ⚠ мигают

- Кофеварка не может приготовить кофе.

- ☞ Поместите сосуд под паровой трубкой и поверните регулятор пара и горячей воды в положение ☕, (рис. 9).

- Кофе вытекает слишком медленно.

- ☞ Поверните ручку настройки тонкости помола (рис. 12) на одно деление по часовой стрелке стрелке, пока мельница во время приготовления кофе размалывает зерна (см. «Настройка тонкости помола», стр. 285).

**Символ  горит непрерывно**

- Контейнер для кофейной гущи полон.
-  Очистите контейнер для кофейной гущи как описано в «Удаление кофейной гущи», стр. 287 и правильно установите его на место.



**Символ  мигает**

- Контейнер для кофейной гущи не был установлен после очистки.
-  Откройте служебную дверцу и установите контейнер для кофейной гущи.

**Символы  или  и  мигают**

- После выбора функции приготовления кофе из молотого кофе в воронку не был засыпан порошок.
-  Засыпьте кофейный порошок, как описано в пункте «Приготовление молотого кофе», стр. 283.

**Все символы для крепости кофе      и  мигают**

- В контейнере для зерен больше нет зерен.
-  Заполните контейнер для зерен, см. «Помещение зерен в контейнер», стр. 278.
- Если при работе кофемолки создается сильный шум, это означает, что мельница заблокирована маленьким камешком, попавшим с зернами.
-  Обратитесь в клиентскую службу. Блокировка или повреждение мельницы, вызванные наличием в ней посторонних предметов, может не подпадать под гарантийный случай.



**Символ  горит непрерывно**

- Указывает на то, что кофеварка покрыта налетом известняка.
-  Необходимо как можно быстрее запустить программу удаления накипи, описанную в главе «Запуск программы удаления накипи», стр. 289.

**Символ  горит непрерывно**

- Открыта служебная дверца.
-  Закройте служебную дверцу. Если служебная дверца не закрывается, убедитесь в том, что правильно вставлен варочный блок (см. «Чистка варочного блока», стр. 288)



**Символ  мигает**

- Возможно, варочный блок не был установлен после очистки.
-  Установите варочный блок, см. «Чистка варочного блока», стр. 288.
- Внутренняя часть машины сильно загрязнена.
-  Тщательно очистите внутреннюю часть прибора, см. «Чистка варочного блока», стр. 288. Если после очистки сообщение не пропадет, обратитесь в клиентскую службу.

**Символ  горит непрерывно**

- Это означает общий аварийный сигнал.
-  Обратитесь в клиентскую службу.

**Символы  и  мигают**

- Прибор был включен с регулятором пара и горячей воды в положении «открыто» .
-  Поверните регулятор пара и горячей воды по часовой стрелке (рис. 10) до упора в положение .

**Символы  и  мигают**

- Слишком низкая температура окружающей среды, недостаточно теплая для эксплуатации прибора.
-  Используйте машину в более теплом помещении.

## 16 Проблемы, которые можно устранить перед тем, как позвонить в клиентскую службу

Если кофеварка не работает, причину сбоя можно найти и устранить самостоятельно, воспользовав-

RUS

шись главой «Что делать, если на дисплее появится следующее сообщение...», стр. 290. Если кофеварка не отображает каких-либо символов, выполните следующие меры контроля перед тем, как обратиться в клиентскую службу.

#### Кофе не горячий.

- Чашки не были подогреты.
- ☞ Чтобы подогреть чашки, их нужно ополоснуть теплой водой или поставить как минимум на 20 минут на подогреваемую площадку для чашек (H) (см. «Советы по розливу горячего кофе:», стр. 281).

#### В кофе слишком мало пенки.

- Кофе слишком крупно помолот.
- ☞ Поверните ручку настройки тонкости помола на одно деление против часовой стрелки, пока мельница во время приготовления кофе размалывает зерна (см. «Настройка тонкости помола», стр. 285).
- неподходящая смесь для кофе.
- ☞ Используйте смесь, предназначенную для автоматических кофеварок.

#### Кофе вытекает слишком медленно.

- Кофе слишком тонко помолот.
- ☞ Поверните ручку настройки тонкости помола на одно деление по часовой стрелке, пока мельница во время приготовления кофе размалывает зерна (см. «Настройка тонкости помола», стр. 285).

#### Кофе вытекает слишком быстро.

- Кофе слишком крупно помолот.
- ☞ Поверните ручку настройки тонкости помола на одно деление против часовой стрелки, пока мельница во время приготовления кофе размалывает зерна (см. «Настройка тонкости помола», стр. 285).

#### Кофе вытекает только из одного отверстия выпускной трубки.

- Отверстия засорились.
- ☞ Счистите присохший кофе иголкой (рис. 29).

#### При повороте регулятора пара и горячей воды из паровой трубки не выходит пар.

- Засорились мелкие отверстия паровой трубки и внутренней части паровой трубки.
- ☞ Необходимо прочистить отверстия паровой трубки и внутренней части паровой трубки (см. «Прочистка паровой трубки», стр. 285).

#### При выборе функции ☞ или ☞☞, из прибора вытекает не кофе, а вода

- Кофейный порошок застрял в воронке.
- ☞ Устраните застрявший в воронке порошок с помощью ножа (см. «Приготовление молотого кофе», стр. 283) (рис. 22). Затем очистите варочный блок и внутреннюю часть машины (см. «Чистка варочного блока», стр. 288).

#### Кофеварка не включается при нажатии клавиши ①.

- Главный выключатель на задней стороне прибора не включен (рис. 8), или не вставлен сетевой штекер.
- ☞ Убедитесь в том, что главный выключатель находится в положении «I» и что сетевой кабель правильно вставлен в розетку.

#### Невозможно вынуть варочный блок для очистки.

- Кофеварка включена. Варочный блок можно вынуть только из выключенного прибора.
- ☞ Выключите прибор и извлеките варочный блок (см. раздел «Чистка варочного блока», стр. 288).

**i** **Внимание! Варочный блок можно достать только, если прибор от-**

**ключен с помощью клавиши «вкл./выкл.» ① на передней части прибора. Прибор нельзя отключать от сети. Попытка вынуть варочный блок при включенной кофеварке может привести к повреждению прибора.**

**Кофе вытекает не из отверстий выпускной трубы, а сбоку из служебной дверцы.**

- Отверстия выпускной трубы засорились засохшим кофе.
- ☞ Счистите присохший кофе иголкой (рис. 29).
- Откидная полка (R), расположенная с внутренней части служебной дверцы, заблокирована и не откидывается.
- ☞ Тщательно очистите откидную полку, в особенности вблизи шарниров, чтобы они могли свободно двигаться.

**Вместо кофейных зерен использовался кофейный порошок, и кофеварка не выдает кофе.**

- Засыпано слишком много молотого кофе.
- ☞ Выньте варочный блок и тщательно очистите внутреннюю часть прибора как описано в «Чистка варочного блока», стр. 288. Повторите операцию, не засыпайте больше двух мерных ложек без горки кофейного порошка.
- Регулятор «Крепость кофе / молотый кофе» не установлен в положение ☞ или ☞, и прибор использует и молотый кофе, и кофейный порошок, полученный из кофемолки.
- ☞ Тщательно очистите внутреннюю часть прибора как описано в «Чистка варочного блока», стр. 288. Повторите операцию, при этом сначала установите регулятор «Крепость кофе / молотый кофе» в нужное положение, как описано в разделе «Приготовление молотого кофе», стр. 283.

- Молотый кофе был засыпан в выключенную кофеварку.

☞ Выньте варочный блок и тщательно очистите внутреннюю часть прибора как описано в «Чистка варочного блока», стр. 288. Повторите операцию при включенной кофеварке.

**Что делать, если прибор необходимо перевезти в другое место?**

- Перевозите прибор только в оригинальной упаковке. Для защиты от царапин обязательно используйте оригинальный пластиковый пакет.
- Предохраняйте прибор и термокувшин от ударов. Гарантия не распространяется на повреждения, произошедшие во время перевозки.
- Прибор всегда отправляйте вместе с термокувшином. Он требуется для тестирования прибора.
- Опустошите емкость для воды и контейнер для кофейной гущи.
- Внимательно относитесь к подбору места расположения прибора, особенно в холодное время года. Воздействие минусовой температуры может привести к повреждению прибора.

## 17 Режим статистики

Прибор позволяет запрашивать следующие значения:

- общее количество кофе, изготовленного прибором к данному моменту,
- количество приготовленных кувшинов на 4 чашки, 6 чашек, 8 чашек и 10 чашек,
- количество выполненных процедур удаления накипи, а также
- количество литров воды, выданных машиной.





☛ Если одновременно заваривается две чашки кофе, то счетчик увеличивается на 2.

RUS

Для возможности включения режима статистики прибор должен быть выключен.

 При необходимости выключите прибор, нажав клавишу «вкл./выкл» (рис. 11).

 Нажмите клавишу «Р» (рис. 4) и удерживайте, по крайней мере, 6 секунд.

Загорятся символы «Р» и . Кроме того, загорятся 3 малых символа над клавишами ,  и  для отображения актуальной функции этих клавиш, см. «Специальный режим», стр. 277

 Нажимайте клавиши перемещения «<<» или «>>» (рис. 5) до тех пор, пока не загорится символ, для которого необходимо отобразить соответствующую статистику:

 Количество приготовленных порций кофе

 Количество проведенных процедур удаления накипи

 Количество приготовленных кувшинов из 4 чашек

 Количество приготовленных кувшинов из 6 чашек

 Количество приготовленных кувшинов из 8 чашек

 Количество приготовленных кувшинов из 10 чашек

 Количество выданных литров воды

Если символ горит, соответствующее количество можно отобразить следующим образом:

 Нажмите и удерживайте клавишу «OK» (рис. 5).

Теперь отдельные сообщения начнут попеременно мигать, отображая запрошенную статистику:

 1 вспышка 1

 1 вспышка 10

 1 вспышка 100

 1 вспышка 1,000

 1 вспышка 10,000

Индикаторы будут продолжать попеременно мигать до тех пор, пока не будет нажата клавиша «OK». Перед каждым повторением имеется пауза в 3 секунды.

 Сосчитайте количество вспышек каждого индикатора.

Например, приведенная ниже последовательность соответствует числу 1529.

 9 вспышек

 2 вспышки

 5 вспышек

 1 вспышка

 0 вспышек

 Для выхода из режима статистики нажмите клавишу «Р» (рис. 4) и удерживайте, по крайней мере, 6 секунд.

## 18 Технические характеристики

Напряжение в сети: 220-240 В

Потребляемая мощность: 1350 Вт

 Характеристики прибора соответствуют следующим директивам ЕС:

- 73/23/ЕЭС от 19.02.1973 г. «О низком напряжении», включая поправки 93/68/ЕЭС.
- 89/336/ЕЭС от 03.05.1989 г. «Об электромагнитной совместимости», включая поправки 92/31/ЕЭС.

## 19 Утилизация



### Упаковочные материалы

Упаковочные материалы экологически безопасны и пригодны для вторичного использования. Синтетические части снабжены специальной маркировкой, например: >PE<, >PS< и т.д. Помещайте упаковочные материалы в соответствии с маркировкой в специальные контейнеры для сбора утиля, установленные местной коммунальной службой.



### Старый прибор

Символ  на изделии или на его упаковке указывает, что оно не подлежит утилизации в качестве бытовых отходов. Вместо этого его следует сдать в соответствующий пункт приемки электронного и электрооборудования для последующей утилизации. Соблюдая правила утилизации изделия, Вы можете предотвратить нанесение вреда окружающей среде и здоровью людей. Неправильная утилизация подвергает опасности людей и окружающую среду. За более подробной информацией об утилизации этого изделия просьба обращаться к местным властям, в службу по вывозу и утилизации отходов или в магазин, в котором Вы приобрели изделие.

## 20 Клиентская служба

Храните оригинальную упаковку, включая прокладки из пеноматериалов. Тщательно упаковывайте прибор перед перевозкой. Прибор всегда отправляйте вместе с термокувшином. Он требуется для тестирования прибора.

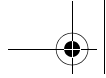

RUS

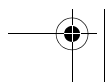
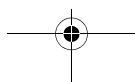
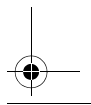
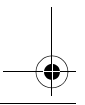
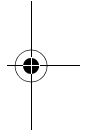
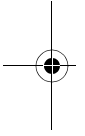



## GR **Αγαπητή πελάτισσα, αγαπητέ πελάτη,**

Παρακαλούμε να διαβάσετε προσεκτικά το παρόν εγχειρίδιο οδηγιών χρήσης. Δώστε ιδιαίτερη προσοχή στις υποδείξεις ασφαλείας! Φυλάξτε το παρόν εγχειρίδιο οδηγιών χρήσης για μελλοντική αναφορά και παραχωρήστε το σε ενδεχόμενο μελλοντικό χρήστη της συσκευής.

### Περιεχόμενα

<b>1</b>	<b>Λεζάντα εικόνας</b>	<b>298</b>	<b>11</b>	<b>Ρύθμιση βαθμού αλέσματος</b>	<b>311</b>
1.1	Μπροστινή όψη (εικόνα 1)	298	<b>12</b>	<b>Ρύθμιση θερμοκρασίας καφέ</b>	<b>312</b>
1.2	Μπροστινή όψη με ανοικτό πορτάκι σέρβις (εικόνα 2)	298	<b>13</b>	<b>Καθαρισμός και φροντίδα</b>	<b>313</b>
1.3	Πίνακας ελέγχου (εικόνα 3)	298	13.1	Τακτικός καθαρισμός	313
<b>2</b>	<b>Καφέs και εσπρέσσο</b>	<b>299</b>	13.2	Αδειασμα δοχείου συλλογής υπολειμμάτων καφέ	313
<b>3</b>	<b>Υποδείξεις ασφαλείας</b>	<b>299</b>	13.3	Καθαρισμός του μύλου	314
<b>4</b>	<b>Ειδικός τρόπος λειτουργίας</b>	<b>301</b>	13.4	Καθαρισμός της μονάδας παρασκευής	314
<b>5</b>	<b>Πρώτη θέση σε λειτουργία</b>	<b>301</b>	13.5	Εκτέλεση προγράμματος αφαλάτωσης	315
5.1	Τοποθέτηση και σύνδεση της συσκευής	301	<b>14</b>	<b>Παραγγελία εξαρτημάτων</b>	<b>317</b>
5.2	Πλήρωση νερού	302	<b>15</b>	<b>Τι πρέπει να γίνει όταν στην οθόνη εμφανίζεται το μήνυμα...</b>	<b>317</b>
5.3	Πλήρωση δοχείου κόκκων	302	<b>16</b>	<b>Προβλήματα που μπορούν να επιλυθούν προτού απευθυνθείτε στο τμήμα εξυπηρέτησης πελατών</b>	<b>318</b>
5.4	Πρώτη ενεργοποίηση	303	<b>17</b>	<b>Τρόπος λειτουργίας στατιστικής</b>	<b>321</b>
5.5	Ενεργοποίηση της συσκευής	303	<b>18</b>	<b>Τεχνικά χαρακτηριστικά</b>	<b>322</b>
5.6	Απενεργοποίηση της συσκευής	303	<b>19</b>	<b>Απόρριψη</b>	<b>322</b>
5.7	Ρύθμιση της σκληρότητας νερού	304	<b>20</b>	<b>Σε περίπτωση που χρειαστεί σέρβις</b>	<b>322</b>
<b>6</b>	<b>Παρασκευή καφέ με κόκκους</b>	<b>305</b>			
6.1	Συμβουλές για την εξαγωγή πιο ζεστού καφέ	307			
<b>7</b>	<b>Παρασκευή πολλών φλιτζανιών καφέ με τη λειτουργία κανάτας.</b>	<b>307</b>			
<b>8</b>	<b>Ετοιμασία καφέ με σκόνη</b>	<b>308</b>			
<b>9</b>	<b>Αφρόγαλα</b>	<b>309</b>			
9.1	Καθαρίστε το ακροφύσιο ατμού	310			
<b>10</b>	<b>Παρασκευή ζεστού νερού</b>	<b>311</b>			

GR

## 1 Λεζάντα εικόνας

### 1.1 Μπροστινή όψη (εικόνα 1)

- A** Σχάρα στράγγισης
- B** Κανάτα διατήρησης θερμότητας
- C** Γενικός διακόπτης (πίσω πλευρά συσκευής)
- D** Ρυθμιζόμενο στο ύψος στόμιο εκροής καφέ
- E** Πίνακας ελέγχου (βλέπε εικόνα 3)
- F** Καπάκι δοχείου κόκκων καφέ
- G** Καπάκι θήκης πλήρωσης αλεσμένου καφέ
- H** Θερμαινόμενη βάση φλιτζανιών
- J** Περιστρεφόμενος σωλήνας για ατμό και ζεστό νερό
- K** Ακροφύσιο ατμού (αφαιρούμενο)
- L** Εσωτερικό τμήμα ακροφυσίου ατμού (αφαιρούμενο)
- M** Κουμπί ανοίγματος για το πορτάκι σέρβις
- N** Δοχείο νερού με σημάδι MAX (αφαιρούμενο)
- O** Δοχείο στράγγισης με πλωτήρα (αφαιρούμενο)

### 1.2 Μπροστινή όψη με ανοικτό πορτάκι σέρβις (εικόνα 2)

- P** Πορτάκι σέρβις (ανοικτό)
- Q** Δοχείο συλλογής υπολειμμάτων καφέ (αφαιρούμενο)
- R** Στρεφόμενη θήκη
- S** Μονάδα παρασκευής
- T** Κουμπί ρύθμισης βαθμού αλέσματος
- U** Δοχείο κόκκων καφέ
- V** Μεζούρα
- W** Θήκη πλήρωσης για αλεσμένο καφέ
- X** Πινακίδα τύπου (Κάτω πλευρά συσκευής)
- Y** Υγρό αφαίρεσης αλάτων
- Z** Ταινία ελέγχου

### 1.3 Πίνακας ελέγχου (εικόνα 3)

- a** Περιστροφικό κουμπί "Γεύση καφέ / αλεσμένος καφές"
- b** Περιστροφικό κουμπί "Μέγεθος φλιτζανιού"
- c** Οθόνη
- d** Πλήκτρο "1 φλιτζάνι καφέ" ☐  
Στον ειδικό τρόπο λειτουργίας το πλήκτρο αυτό χρησιμεύει στην "Περιήγηση" ("<")
- e** Πλήκτρο "2 φλιτζάνια καφέ" ☐  
Στον ειδικό τρόπο λειτουργίας το πλήκτρο αυτό χρησιμεύει στην "Περιήγηση" (">")
- f** Πλήκτρο "ατμός" ☼  
Στον ειδικό τρόπο λειτουργίας το πλήκτρο αυτό επιβεβαιώνει το στοιχείο μενού ("OK")
- g** Πλήκτρο "P"  
Στον ειδικό τρόπο λειτουργίας με το πλήκτρο αυτό γίνεται επιστροφή στο τελευταίο επίπεδο, χωρίς να πραγματοποιηθούν αλλαγές ("P")
- h** Πλήκτρο "On/Off" ①
- j** Περιστροφικό κουμπί για ατμό και ζεστό νερό
- k** Πλήκτρο "Jug coffee function (λειτουργία κανάτας)" ☐
- l** Σύμβολο "Αλεσμένος καφές"
- m** Σύμβολο "Κανάτα"
- n** Σύμβολο "Γεύση καφέ"
- o** Σύμβολο "Μέγεθος φλιτζανιού"
- p** Σύμβολο ".οχείο νερού άδειο" ☐
- q** Σύμβολο "Αφαλάτωση" ☐
- r** Σύμβολο "Θερμοκρασία συσκευής" ↓
- s** Σύμβολο "Πορτάκι σέρβις ανοικτό" ☐
- t** Σύμβολο ".οχείο συλλογής υπολειμμάτων καφέ" ☐
- u** Σύμβολο "Προσοχή" ⚠
- v** Σύμβολο "Ζεστό νερό" ☐
- w** Σύμβολο "Ατμός" ☼
- x** Σύμβολο "Παρασκευή 2 φλιτζανιών" ☐
- y** Σύμβολο "Παρασκευή 1 φλιτζανιού" ☐
- z** Σύμβολο για τον ειδικό τρόπο λειτουργίας

## 2 Καφές και εσπρέσσο

Η λειτουργία της αυτόματης μηχανής σας εξασφαλίζει απλούστατο **χειρισμό**, στην προετοιμασία του καφέ καθώς και στη συντήρηση και φροντίδα.

Η εξαιρετική, χαρακτηριστική **γεύση** επιτυγχάνεται χάρη

- στο σύστημα προπαρασκευής: πριν ξεκινήσει ουσιαστικά η διαδικασία παρασκευής, ο αλεσμένος καφές υγραίνεται, έτσι ώστε να αντληθεί όλο του το άρωμα,
- στην εξατομικευμένη ρύθμιση της ποσότητας νερού ανά φλιτζάνι με δυνατότητα επιλογής μεταξύ ενός μικρού φλιτζανιού εσπρέσσο και ενός μεγάλου φλιτζανιού καφέ με καϊμάκι,
- στην εξατομικευμένη ρύθμιση της θερμοκρασίας, με την οποία παρασκευάζεται ο καφές,
- στη δυνατότητα επιλογής μεταξύ κανονικού και δυνατού καφέ,
- στη δυνατότητα ρύθμισης του βαθμού αλέσματος ανάλογα με το καβούρντισμα των κόκκων,
- και τέλος, χάρη στο εγγυημένο καϊμάκι, αυτόν τον κρεμώδη αφρό που κάνει τον καφέ εσπρέσσο μοναδικό για τους γνώστες. Επιπλέον: Στον εσπρέσσο, ο χρόνος επαφής του αλεσμένου καφέ με το νερό είναι πολύ μικρότερος από ό,τι στο συνηθισμένο καφέ φίλτρου. Με αυτό τον τρόπο ελευθερώνονται λιγότερες πικρές ουσίες από τον αλεσμένο καφέ, κι έτσι ο εσπρέσσο γίνεται πολύ πιο εύπεπτος!

## 3 Υποδείξεις ασφαλείας



Η ασφάλεια της παρούσας συσκευής ανταποκρίνεται στους ισχύοντες τεχνολογικούς κανόνες καθώς και στις νομοθετικές διατάξεις σχετικά με την ασφάλεια των συσκευών. Ωστόσο, από την πλευρά μας ως κατασκευαστές, θεωρούμε υποχρέωσή μας να σας γνωστοποιήσουμε τις παρακάτω υποδείξεις ασφαλείας.

### Γενική ασφάλεια

- Η συσκευή πρέπει να συνδέεται σε ηλεκτρικό δίκτυο, με αντίστοιχη τάση, τύπο ρεύματος και συχνότητα σύμφωνα με τα στοιχεία που αναγράφονται στην πινακίδα τεχνικών χαρακτηριστικών (βλέπε κάτω πλευρά της συσκευής)!
- Μην φέρνετε το καλώδιο τροφοδοσίας σε επαφή με θερμά τμήματα της συσκευής.
- Μην τραβάτε ποτέ το βύσμα από την πρίζα πιάνοντάς το από το καλώδιο τροφοδοσίας!
- Μην θέτετε τη συσκευή σε λειτουργία όταν:
  - το καλώδιο τροφοδοσίας έχει υποστεί φθορά ή
  - εντοπίζονται εμφανείς βλάβες στο περίβλημα.
- Τοποθετείτε το βύσμα στην πρίζα μόνον όταν η συσκευή είναι απενεργοποιημένη.
- Η συσκευή δεν προορίζεται για χρήση ή λειτουργία από άτομα (και παιδιά) που λόγω της απειρίας τους ή της έλλειψης γνώσεων δεν είναι σε θέση να τη χειριστούν με ασφάλεια, ούτε από άτομα (και παιδιά) με μειωμένες σωματικές, αισθητηριακές ή πνευματικές ικανότητες, παρά μόνον εφόσον ο ασφαλής τρόπος χειρισμού τους υποδειχθεί από υπεύθυνο για τα άτομα αυτά πρόσωπο, το οποίο και αρχικά θα τα επιτηρεί.

GR

**Ασφάλεια παιδιών**

- Μην αφήνετε τη συσκευή από την επίβλεψή σας κατά τη διάρκεια της λειτουργίας της και δείξτε ιδιαίτερη προσοχή όταν υπάρχουν παιδιά!
- Κρατάτε τα υλικά της συσκευασίας, όπως π.χ. την πλαστική σακούλα, μακριά από παιδιά.

**Ασφάλεια κατά τη λειτουργία**

- Προσοχή! Το στόμιο εκροής καφέ, το ακροφύσιο ατμού και η βάση φλιτζανιών αναπτύσσουν υψηλή θερμοκρασία κατά τη λειτουργία. Κρατήστε μακριά τα παιδιά!
- Προσοχή! Κίνδυνος εγκαυμάτων όταν είναι ενεργοποιημένο το ακροφύσιο ατμού! Το καυτό νερό και ο καυτός ατμός που εξέρχονται μπορούν να προκαλέσουν εγκαυματα. Ενεργοποιείτε το ακροφύσιο ατμού μόνο όταν κρατάτε ένα δοχείο από κάτω.
- Μην θερμαίνετε εύφλεκτα υγρά με ατμό!
- Ενεργοποιείτε τη συσκευή μόνον εφόσον υπάρχει νερό στο σύστημα! Γεμίζετε το δοχείο νερού μόνο με κρύο νερό, μην προσθέτετε ζεστό νερό, γάλα ή άλλα υγρά. Προσέξτε τη μέγιστη χωρητικότητα περίπου 1,8 λίτρων.
- Προσθέτετε μόνο καβουρντισμένους, όχι κατεψυγμένους ή καραμελωμένους κόκκους καφέ στο δοχείο κόκκων! Αφαιρέστε τα ξένα σώματα, π.χ. πετραδάκια, από τους κόκκους καφέ. Το μπλοκάρισμα ή η πρόκληση ζημιάς στο μύλο λόγω της παρουσίας ξένου σώματος, ενδέχεται να μην καλύπτεται από την εγγύηση.
- Προσθέτετε αποκλειστικά αλεσμένο καφέ στο δοχείο καφέ.
- Μην αφήνετε τη συσκευή ενεργοποιημένη χωρίς λόγο.

- Μην εκθέτετε τη συσκευή σε άσχημες καιρικές συνθήκες.
- Σε περίπτωση που χρειαστείτε καλώδιο προέκτασης, χρησιμοποιήστε μόνο κοινό καλώδιο διαμέτρου 1,5 mm<sup>2</sup> τουλάχιστον.
- Άτομα με κινητικές διαταραχές συνιστάται να μην χρησιμοποιούν τη συσκευή χωρίς επίβλεψη, ώστε να αποφευχθούν ενδεχόμενοι κίνδυνοι.
- Θέτετε τη συσκευή σε λειτουργία μόνον εφόσον το δοχείο στράγγισης, το δοχείο συλλογής υπολειμμάτων καφέ και η σχάρα στράγγισης είναι τοποθετημένα!

**Ασφάλεια κατά τον καθαρισμό και τη φροντίδα**

- Λάβετε υπόψη τις υποδείξεις καθαρισμού και αφαίρεσης αλάτων.
- Πριν από τη συντήρηση ή τον καθαρισμό θέστε τη συσκευή εκτός λειτουργίας και τραβήξτε το βύσμα!
- Μην βυθίζετε τη συσκευή στο νερό.
- Καθαρίζετε το ακροφύσιο ατμού μόνο όταν είναι απενεργοποιημένο, κρύο και χωρίς πίεση!
- Μην πλένετε τμήματα της συσκευής στο πλυντήριο πιάτων.
- Μην ρίχνετε ποτέ νερό στο μύλο, καθώς μπορεί να υποστεί ζημιές.

Μην ανοίγετε και μην επισκευάζετε μόνοι σας τη συσκευή. Μπορεί να προκύψουν σοβαροί κίνδυνοι για το χρήστη εξαιτίας ακατάλληλων εργασιών επισκευής.



Οι επισκευές σε ηλεκτρικές συσκευές πρέπει να γίνονται μόνο από εξειδικευμένους τεχνικούς.



Σε περίπτωση που χρειαστεί επισκευή, καθώς και αλλαγή του καλωδίου τροφοδοσίας, παρακαλούμε απευθυνθείτε

- στον αντιπρόσωπο από τον οποίο προμηθευτήκατε τη συσκευή, ή
- καλέστε τη γραμμή εξυπηρέτησης της AEG/ Electrolux.

**Ο κατασκευαστής δεν φέρει καμία ευθύνη για βλάβες που μπορεί να προκύψουν από εσφαλμένη ή διαφορετική από την προβλεπόμενη χρήση, και σε αυτήν την περίπτωση δεν υποχρεούται να τηρήσει την εγγύηση. Το ίδιο ισχύει σε περίπτωση που το πρόγραμμα αφαλάτωσης δεν εκτελεστεί αμέσως μετά την εμφάνιση του συμβόλου  και βάσει των οδηγιών του παρόντος εγχειριδίου οδηγιών χρήσης. Το μπλοκάρισμα ή η πρόκληση ζημιάς στο μύλο λόγω της παρουσίας ξένου σώματος, ενδέχεται να μην καλύπτεται από την εγγύηση.**

## 4 Ειδικός τρόπος λειτουργίας

Για τη ρύθμιση της σκληρότητας του νερού („Ρύθμιση της σκληρότητας νερού“ Σελίδα 304) και της θερμοκρασίας του καφέ („Ρύθμιση θερμοκρασίας καφέ“ Σελίδα 312), για την εκκίνηση του προγράμματος αφαλάτωσης („Εκτέλεση προγράμματος αφαλάτωσης“ Σελίδα 315) και για τη μελέτη των στατιστικών στοιχείων („Τρόπος λειτουργίας στατιστικής“ Σελίδα 321), μεταβείτε στον ειδικό τρόπο λειτουργίας με το πάτημα του πλήκτρου "P" (εικόνα 4). Στον ειδικό τρόπο λειτουργίας τα πλήκτρα "1 φλιτζάνι καφέ" , "2 φλιτζάνια καφέ" , "Ατμός"  και "P" χρησιμεύουν στην πλοήγηση. Η εκάστοτε λειτουργία εμφανίζεται στην οθόνη πάνω από το πλήκτρο (εικόνα 5):

- Τα πλήκτρα "<" ("1 φλιτζάνι καφέ" ) και ">" ("2 φλιτζάνια καφέ" ) επιτρέπουν την "περιήγηση" στο μενού
- Με το "OK" ("Ατμός" ) επιβεβαιώνετε ένα σημείο.
- Με το "P" ("P") επιστρέφετε στο προηγούμενο επίπεδο, χωρίς να πραγματοποιηθούν αλλαγές

## 5 Πρώτη θέση σε λειτουργία

### 5.1 Τοποθέτηση και σύνδεση της συσκευής

Τοποθετήστε τη συσκευή σε μία κατάλληλη, οριζόντια, σταθερή, μη θερμαινόμενη, στεγνή και υδατοστεγή επιφάνεια.



Φροντίστε για σωστή κυκλοφορία του αέρα γύρω από τη συσκευή. Στα πλάγια και πίσω από τη συσκευή πρέπει να υπάρχει ελεύθερος χώρος τουλάχιστον 5 cm, και πάνω από τη συσκευή τουλάχιστον 20 cm.

GR

Η συσκευή δεν επιτρέπεται να τοποθετείται σε χώρους, στους οποίους η θερμοκρασία ενδέχεται να πέσει στους 0°C ή και χαμηλότερα (πρόκληση ζημιών στη συσκευή από το νερό που παγώνει).

 Προσοχή! Αν η συσκευή μεταφερθεί από κρύο σε ζεστό περιβάλλον, περιμένετε περ. 2 ώρες πριν τη θέσετε σε λειτουργία!

Συνιστούμε να τοποθετήσετε μία κατάλληλη βάση κάτω από τη συσκευή προκειμένου να αποφύγετε ζημιές από πιτσιλιές.

 Συνδέετε τη συσκευή μόνο σε γειωμένη πρίζα. Μη χρησιμοποιείτε πρίζα που δεν διαθέτει γείωση.

## 5.2 Πλήρωση νερού

Πριν από κάθε ενεργοποίηση βεβαιωθείτε ότι υπάρχει νερό μέσα στο δοχείο νερού και αν χρειαστεί συμπληρώστε την απαιτούμενη ποσότητα. Σε κάθε ενεργοποίηση και απενεργοποίηση η συσκευή χρειάζεται νερό για τις λειτουργίες αυτόματου πλυσίματος.

 Αφαιρέστε το δοχείο νερού από τη συσκευή (εικόνα 6). Προτού αφαιρέσετε το δοχείο νερού, στρέψτε πάντοτε το ακροφύσιο ατμού προς το κέντρο της συσκευής, γιατί διαφορετικά το δοχείο δεν μπορεί να αφαιρεθεί.

 Γεμίστε το δοχείο νερού με φρέσκο κρύο νερό. Ποτέ μη γεμίζετε το δοχείο πάνω από το σημάδι MAX.

 Γεμίζετε το δοχείο μόνο με κρύο νερό. Ποτέ μην προσθέτετε άλλα υγρά, όπως π.χ. μεταλλικό νερό ή γάλα.

 Τοποθετήστε το δοχείο νερού ξανά στη συσκευή (εικόνα 6). Πιέστε δυνατά το δοχείο, έτσι ώστε η βαλβίδα του δοχείου νερού να ανοίξει.

 Για να παρασκευάζετε πάντοτε αρωματικό καφέ, συνιστάται:

- να αλλάζετε καθημερινά το νερό στο δοχείο νερού,
- να πλένετε το δοχείο νερού τουλάχιστον μία φορά την εβδομάδα σε σαπουνόνερο (όχι στο πλυντήριο πιάτων). Στη συνέχεια ξεπλένετε με φρέσκο νερό.

## 5.3 Πλήρωση δοχείου κόκκων

 Ανοίξτε το καπάκι του δοχείου κόκκων καφέ και γεμίστε το με φρέσκους κόκκους καφέ (εικόνα 7). Στη συνέχεια κλείστε ξανά το καπάκι.

 Προσοχή! Προσθέτετε μόνο καβουρντισμένους, όχι κατεψυγμένους ή καραμελωμένους κόκκους καφέ στο δοχείο κόκκων! Φροντίστε να μην εισέλθουν ξένα σώματα, όπως π.χ. πετραδάκια, στο δοχείο κόκκων. **Το μπλοκάρισμα ή η πρόκληση ζημιών στο μύλο λόγω της παρουσίας ξένου σώματος, ενδέχεται να μην καλύπτεται από την εγγύηση.**

 Ο μύλος είναι ρυθμισμένος από το εργοστάσιο στη μέση βαθμίδα άλεσης. Αν χρειαστεί, μπορείτε να αλλάξετε αυτήν τη ρύθμιση. Υποδείξεις σχετικά με την αλλαγή του βαθμού αλέσματος θα βρείτε στην ενότητα „Ρύθμιση βαθμού αλέσματος“ Σελίδα 311.

 **Ο βαθμός αλέσματος επιτρέπεται να τροποποιείται μόνο κατά τη διάρκεια της διαδικασίας αλέσματος. Οι ρυθμίσεις σε ακινητοποιημένο μύλο μπορεί να προκαλέσουν ζημιές στην καφετιέρα.**

 Η καφετιέρα έχει ελεγχθεί στο εργοστάσιο. Για το σκοπό αυτόν έχει χρησιμοποιηθεί καφές, πράγμα που σημαίνει ότι είναι φυσικό να βρείτε λίγο καφέ στο

μύλο. Σε κάθε περίπτωση παρέχεται εγγύηση ότι η καφετιέρα είναι καινούργια.

#### 5.4 Πρώτη ενεργοποίηση

Την πρώτη φορά που θα θέσετε τη συσκευή σε λειτουργία, πρέπει να την εξαρώσετε.

- ☞ Ενεργοποιήστε τη συσκευή με το γενικό διακόπτη στην πίσω πλευρά της συσκευής (εικόνα 8).

Την πρώτη φορά που θα ενεργοποιηθεί ο γενικός διακόπτης, ανάβουν για μερικά δευτερόλεπτα στην οθόνη όλα τα σύμβολα στα πλαίσια ενός αυτοελέγχου, και στη συνέχεια αναβοσβήνουν τα σύμβολα ☞ και ▲.

- ☞ Γεμίστε τη δεξαμενή νερού, βλ. „Πλήρωση νερού“ Σελίδα 302.
- ☞ Τοποθετήστε το δοχείο νερού ξανά στη συσκευή (εικόνα 6). Πιέστε δυνατά το δοχείο, έτσι ώστε η βαλβίδα του δοχείου νερού να ανοίξει.
- ☞ Στρέψτε το ακροφύσιο ατμού προς τα έξω και βάλτε από κάτω ένα φλιτζάνι (εικόνα 9).
- ☞ Στρέψτε το περιστροφικό κουμπί ατμού και ζεστού νερού όσο το δυνατόν περισσότερο προς τα αριστερά στη θέση ☞☞ (εικόνα 10). Μια μικρή ποσότητα νερού εκρέει από το ακροφύσιο ατμού. Τα σύμβολα ☞☞ και ▲ ανάβουν διαρκώς. Όταν το φλιτζάνι έχει γεμίσει με περίπου 30 ml νερού, τα σύμβολα ☞☞ και ▲ αρχίζουν να αναβοσβήνουν.
- ☞ Στρέψτε το περιστροφικό κουμπί ατμού και ζεστού νερού όσο το δυνατόν περισσότερο προς τα δεξιά στη θέση ● (εικόνα 10) για να σταματήσετε την εκροή νερού. Το σύμβολο ↓ αναβοσβήνει για μερικά δευτερόλεπτα και η συσκευή απενεργοποιείται.

- ☞ Γεμίστε το δοχείο κόκκων καφέ με κόκκους καφέ, βλ. „Πλήρωση δοχείου κόκκων“ Σελίδα 302.

#### 5.5 Ενεργοποίηση της συσκευής

Πριν από κάθε ενεργοποίηση βεβαιωθείτε ότι υπάρχει νερό μέσα στο δοχείο νερού και αν χρειαστεί συμπληρώστε την απαιτούμενη ποσότητα. Σε κάθε ενεργοποίηση και απενεργοποίηση η συσκευή χρειάζεται νερό για τις λειτουργίες αυτόματου πλυσίματος.

- ☞ Θέστε τη συσκευή σε λειτουργία με το πλήκτρο "On/Off" ① (εικόνα 11).

- i Αμέσως μετά την ενεργοποίηση εκτελείται η λειτουργία ρύθμισης της συσκευής. Οι ήχοι που συνοδεύουν αυτή τη διαδικασία είναι απόλυτα φυσιολογικοί.

- i Κατά τη διάρκεια της προθέρμανσης (περίπου 120 δευτερόλεπτα) αναβοσβήνει το σύμβολο ↓. Κατά τη διάρκεια της προθέρμανσης η συσκευή ξεπλένεται αυτόματα (μια μικρή ποσότητα ζεστού νερού εκρέει από το στόμιο εκροής καφέ και συλλέγεται στο δοχείο στράγγισης). Όταν ολοκληρωθεί η προθέρμανση το σύμβολο ↓ ανάβει διαρκώς. Η συσκευή είναι πλέον έτοιμη προς χρήση. Ανάβουν τα σύμβολα που αντιστοιχούν στον τελευταίο επιλεγμένο τρόπο λειτουργίας παρασκευής καφέ.

#### 5.6 Απενεργοποίηση της συσκευής

- ☞ Απενεργοποιήστε τη συσκευή με το πλήκτρο "On/Off" ① (εικόνα 11). Το σύμβολο ↓ αναβοσβήνει. Η συσκευή εκτελεί μια διαδικασία έκπλυσης και η συσκευή απενεργοποιείται.

GR

**i** Η συσκευή απενεργοποιείται αυτόματα μετά από τρεις ώρες, εφόσον δεν χρησιμοποιείται, για λόγους εξοικονόμησης ενέργειας.

**i** Αν η συσκευή δεν πρόκειται να χρησιμοποιηθεί για μεγάλο χρονικό διάστημα, μετά την απενεργοποίηση με το πλήκτρο "On/Off" θα πρέπει να κλείσετε τη συσκευή και με το γενικό διακόπτη που βρίσκεται στο πίσω μέρος της (σχ. 8).

### 5.7 Ρύθμιση της σκληρότητας νερού

Μετά την πρώτη θέση σε λειτουργία ή σε περίπτωση χρήσης άλλης ποιότητας νερού συνιστάται να προσαρμόζετε τη συσκευή στο βαθμό σκληρότητας νερού που αντιστοιχεί στην τοπική σκληρότητα του νερού. Χρησιμοποιήστε τη συνοδευτική ράβδο ελέγχου για τον προσδιορισμό του βαθμού σκληρότητας του νερού ή ρωτήστε την εταιρεία ύδρευσης της περιοχής σας.

#### Προσδιορισμός του βαθμού σκληρότητας του νερού

**i** Βυθίστε την ταινία ελέγχου για 1 δευτερόλεπτο περίπου σε κρύο νερό. Χύστε το επιπλέον νερό και προσδιορίστε το βαθμό σκληρότητας με τη βοήθεια των ροζ πεδίων στην ταινία.

 **Κανένα ή ένα ροζ πεδίο: Βαθμός σκληρότητας 1, μαλακό**  
έως 1,24 mmol/l, ή  
έως 7° σε γερμανικούς βαθμούς, ή  
έως 12,6° σε γαλλικούς βαθμούς





 **Δύο ροζ πεδία: Βαθμός σκληρότητας 2, μέτρια σκληρότητα**  
έως 2,5 mmol/l, ή  
έως 14° σε γερμανικούς βαθμούς, ή  
έως 25,2° σε γαλλικούς βαθμούς

 **Τρία ροζ πεδία: Βαθμός σκληρότητας 3, σκληρό**  
έως 3,7 mmol/l, ή  
έως 21° σε γερμανικούς βαθμούς, ή  
έως 37,8° σε γαλλικούς βαθμούς

 **Τέσσερα ροζ πεδία: Βαθμός σκληρότητας 4, πολύ σκληρό**  
πάνω από 3,7 mmol/l, ή  
πάνω από 21° σε γερμανικούς βαθμούς, ή  
πάνω από 37,8° σε γαλλικούς βαθμούς





#### Ρύθμιση και αποθήκευση του προσδιορισμένου βαθμού σκληρότητας νερού

Μπορείτε να ρυθμίσετε 4 βαθμούς σκληρότητας. Η συσκευή είναι ρυθμισμένη από το εργοστάσιο στο βαθμό σκληρότητας 4.

**i** Με ενεργοποιημένη τη συσκευή πατήστε το πλήκτρο "P" (εικόνα 4). Ανάβουν τα σύμβολα "P" και . Επιπλέον ανάβουν τα 3 μικρά σύμβολα πάνω από τα πλήκτρα ,  και , για να δηλώσουν τη λειτουργία των συγκεκριμένων πλήκτρων τη δεδομένη στιγμή, βλέπε „Ειδικός τρόπος λειτουργίας“ Σελίδα 301.

**i** Επιβεβαιώστε με το πλήκτρο "OK" (εικόνα 5).

Στην οθόνη εμφανίζεται η τρέχουσα ρύθμιση. Οι βαθμοί σκληρότητας εμφανίζονται ως εξής:

 Βαθμός σκληρότητας 1  
 Βαθμός σκληρότητας 2  
 Βαθμός σκληρότητας 3  
 Βαθμός σκληρότητας 4

**i** Στη συνέχεια πατήστε τα πλήκτρα περιήγησης "<" ή ">" (εικόνα 5) τόσες φορές, ωστόσο εμφανιστεί ο προσδιορισμένος βαθμός σκληρότητας.



☞ Επιβεβαιώστε την επιλογή με το πλήκτρο "OK" (εικόνα 5). Ο συγκεκριμένος βαθμός σκληρότητας αποθηκεύεται.

**i** Για να διακόψετε χωρίς να αποθηκεύσετε, πατήστε το πλήκτρο "P" αντί για το "OK". Εάν το "OK" δεν πατηθεί, η συσκευή επιστρέφει αυτόματα, μετά από 120 δευτερόλεπτα περίπου, στον τρόπο λειτουργίας παρασκευής καφέ, χωρίς να γίνει αποθήκευση των ρυθμίσεων.

☞ Για επιστροφή στον τρόπο λειτουργίας παρασκευής καφέ, πατήστε στη συνέχεια το πλήκτρο "P" (εικόνα 4) ή περιμένετε περ. 120 δευτ., ωστόσο η συσκευή επιστρέφει αυτόματα στον τρόπο λειτουργίας παρασκευής καφέ.

## 6 Παρασκευή καφέ με κόκκους

Κατά την παρασκευή καφέ με κόκκους, η παρακάτω διαδικασία διεξάγεται **πλήρως αυτόματα**: Άλεσμα, δΟΣολογία, συμπίεση, προπαρασκευή, παρασκευή και εξαγωγή του χρησιμοποιημένου αλεσμένου καφέ.

Χάρη στη δυνατότητα επιλογής του βαθμού αλέσματος και της ποσότητας για άλεσμα, μπορείτε να προσαρμόσετε τη συσκευή στις προτιμήσεις σας

**!** Προσοχή! Προσθέτετε μόνο καβουρντισμένους, όχι κατεψυγμένους ή καραμελωμένους κόκκους καφέ στο δοχείο κόκκων! Φροντίστε να μην εισέλθουν ξένα σώματα, όπως π.χ. πετραδάκια, στο δοχείο κόκκων. **Το μπλοκάρισμα ή η πρόκληση ζημιάς στο μύλο λόγω της παρουσίας ξένου σώματος, ενδέχεται να μην καλύπτεται από την εγγύηση.**

Επιλέξτε σύμφωνα με τις προτιμήσεις σας ένα μικρό φλιτζάνι εσπρέσσο ή ένα μεγάλο φλιτζάνι καφέ με καϊμάκι.

☞ Επιλέξτε το επιθυμητό μέγεθος φλιτζανιού με το περιστροφικό κουμπί "Μέγεθος φλιτζανιού" (εικόνα 12). Εμφανίζεται το επιλεγμένο μέγεθος φλιτζανιού.

**i** Τα μεγέθη των φλιτζανιών εμφανίζονται ως εξής:

☐	φλιτζάνι εσπρέσσο
☐ ☐	μικρό φλιτζάνι
☐ ☐ ☐	μεσαίο φλιτζάνι
☐ ☐ ☐ ☐	μεγάλο φλιτζάνι
☐ ☐ ☐ ☐ ☐	κούπα

Μπορείτε να επιλέξετε ο καφές σας να είναι πολύ ελαφρύς, ελαφρύς, κανονικός, δυνατός ή πολύ δυνατός.

☞ Επιλέξτε την επιθυμητή γεύση καφέ με το περιστροφικό κουμπί "Γεύση καφέ" (εικ. 13). Εμφανίζεται η επιλεγμένη γεύση καφέ.

**i** Η γεύση καφέ εμφανίζεται ως εξής:

☉	πολύ ελαφρύς
☉☉	ελαφρύς
☉☉☉	κανονικός
☉☉☉☉	δυνατός
☉☉☉☉☉	πολύ δυνατός

☞ Τοποθετήστε ένα ή δύο φλιτζάνια κάτω από το στόμιο εκροής καφέ (εικόνα 14). Ωθώντας το στόμιο εκροής καφέ προς τα πάνω ή κάτω, μπορείτε να προσαρμόσετε το ύψος του στομίου στο ύψος των φλιτζανιών σας, προκειμένου να ελαττώσετε την απώλεια θερμότητας και τις πιτσιλιές (εικόνα 15).

☞ Πατήστε το πλήκτρο "1 φλιτζάνι καφέ" ☐ για να ετοιμάσετε ένα φλιτζάνι, ή το πλήκτρο "2 φλιτζάνια" ☐ για 2 φλιτζάνια.

Ανάβει το σύμβολο "1 φλιτζάνι" ☐ ή "2 φλιτζάνια" ☐. Η συσκευή αλέθει τώρα τους κόκκους. Κατά την παρασκευή του καφέ ο αλεσμένος καφές υγραίνεται

(GR)

καταρχάς με λίγο νερό (προπαρασκευή). Έπειτα από μία σύντομη διακοπή ακολουθεί η κανονική διαδικασία παρασκευής. Ο καφές εκρέει στο φλιτζάνι.

Όταν η ποσότητα καφέ που επιθυμείτε είναι έτοιμη, η συσκευή διακόπτει αυτόματα την εκροή και ρίχνει το χρησιμοποιημένο αλεσμένο καφέ στο δοχείο συλλογής υπολειμμάτων καφέ. Στο διάστημα αυτό αναβοσβήνει το σύμβολο "1 φλιτζάνι" ☐ ή "2 φλιτζάνια" ☐.

- ☞ Μπορείτε ανά πάσα στιγμή να διακόψετε πρόωρα την εκροή καφέ, πατώντας και πάλι στιγμιαία το πλήκτρο "1 Φλιτζάνι" ☐ ή "2 φλιτζάνια" ☐ που είχατε πατήσει προηγουμένως, ή γυρίζοντας προς τα αριστερά το περιστροφικό κουμπί „Μέγεθος φλιτζανιού“ (εικόνα 12), προς την κατεύθυνση της ένδειξης "Φλιτζάνι εσπρέσσο".
- ☞ Μόλις ολοκληρωθεί η εκροή καφέ, μπορείτε να αυξήσετε την ποσότητα καφέ πατώντας και κρατώντας πατημένο το πλήκτρο "1 φλιτζάνι" ☐ ή "2 φλιτζάνια" ☐, μέχρι να επιτευχθεί η επιθυμητή ποσότητα, ή γυρίζοντας το περιστροφικό κουμπί "Μέγεθος φλιτζανιού" (εικόνα 12) προς τα δεξιά προς την κατεύθυνση της ένδειξης "Κούπα" (αυτό πρέπει να συμβεί αμέσως μόλις σταματήσει η εκροή καφέ και προτού ο χρησιμοποιημένος αλεσμένος καφές απορριφθεί στο δοχείο συλλογής υπολειμμάτων καφέ). Μετά από μερικά δευτερόλεπτα, όταν σβήσει το σύμβολο "1 φλιτζάνι" ☐ ή "2 φλιτζάνια" ☐, η συσκευή είναι και πάλι έτοιμη για λειτουργία και μπορείτε να ετοιμάσετε τον επόμενο καφέ σας.
- i** Όταν ο καφές εκρέει σε σταγόνες ή δεν εκρέει καθόλου, ή όταν ο καφές εκρέει υπερβολικά γρήγορα και η

κρέμα δεν είναι ικανοποιητική για τις προτιμήσεις σας, θα πρέπει να τροποποιήσετε τη ρύθμιση βαθμού αλέσματος, δείτε „Ρύθμιση βαθμού αλέσματος“ Σελίδα 311.

- i** Όταν αναβοσβήνουν τα σύμβολα ☐ και ☐, ο καφές είναι υπερβολικά ψιλοαλεσμένος. Συνιστούμε να αλλάξετε τη ρύθμιση του βαθμού αλέσματος, βλέπε „Ρύθμιση βαθμού αλέσματος“ Σελίδα 311.
- i** Όταν ανάβει το σύμβολο ☐, πρέπει να γεμίσετε το δοχείο νερού, διαφορετικά η συσκευή δεν μπορεί να παρασκευάσει καφέ. (Είναι φυσιολογικό να υπάρχει ακόμα μια μικρή ποσότητα νερού στο δοχείο νερού όταν εμφανίζεται το σύμβολο.).
- i** Όταν ανάβει το σύμβολο ☐, το δοχείο συλλογής υπολειμμάτων καφέ είναι γεμάτο και πρέπει να το αδειάσετε και να το καθαρίσετε, βλέπε „Άδειασμα δοχείου συλλογής υπολειμμάτων καφέ“ Σελίδα 313. Μέχρι να καθαριστεί το δοχείο συλλογής υπολειμμάτων καφέ, το σύμβολο ανάβει και η καφετιέρα δεν μπορεί να παρασκευάσει καφέ.
- i** Κατά τη διάρκεια της εκροής καφέ, μη βγάξετε ποτέ το δοχείο νερού. Αν αφαιρεθεί το δοχείο, η καφετιέρα δεν μπορεί πλέον να παρασκευάσει καφέ. Για την εξαέρωση της καφετιέρας, στρέψτε το περιστροφικό κουμπί ατμού και ζεστού νερού όσο το δυνατόν περισσότερο προς τα αριστερά στη θέση ☐☐☐ και αφήστε να τρέξει για λίγα δευτερόλεπτα νερό από το ακροφύσιο ατμού.
- i** Κατά την πρώτη θέση σε λειτουργία, θα πρέπει να παρασκευάσετε τουλάχιστον 4-5 φλιτζάνια καφέ, μέχρις ότου το μηχάνημα να προσφέρει ένα ικανοποιητικό αποτέλεσμα.

### 6.1 Συμβουλές για την εξαγωγή πιο ζεστού καφέ:

- Όταν αμέσως μετά την ενεργοποίηση της καφετιέρας θέλετε να παρασκευάσετε την ποσότητα για ένα μικρό φλιτζάνι καφέ (κάτω από 60 ml), χρησιμοποιήστε το καυτό νερό της διαδικασίας έκπλυσης για την προθέρμανση του φλιτζανιού.
- Ρυθμίστε στο αντίστοιχο μενού μια μεγαλύτερη θερμοκρασία καφέ, βλ. „Ρύθμιση θερμοκρασίας καφέ“ Σελίδα 312.
- Μη χρησιμοποιείτε φλιτζάνια με πολύ μεγάλο πάχος, εκτός κι αν τα προθερμαίνετε, δεδομένου ότι απορροφούν υπερβολική ποσότητα θερμότητας.
- Χρησιμοποιείτε προθερμασμένα φλιτζάνια, ξεπλένοντάς τα με ζεστό νερό ή αφήνοντάς τα τουλάχιστον για 20 λεπτά στη ζεστή βάση φλιτζανιών (H) της ενεργοποιημένης καφετιέρας.

## 7 Παρασκευή πολλών φλιτζανιών καφέ με τη λειτουργία κανάτας.

Με αυτήν τη λειτουργία μπορείτε να παρασκευάσετε εντελώς αυτόματα **πολλά φλιτζάνια καφέ στη συνοδευτική κανάτα διατήρησης θερμότητας από ανοξείδωτο χάλυβα**: Άλεσμα, δοσολογία, συμπίεση, προπαρασκευή, παρασκευή και εξαγωγή του χρησιμοποιημένου αλεσμένου καφέ. όπως περιγράφεται στο προηγούμενο κεφάλαιο.

- ☞ Γυρίστε το καπάκι της συνοδευτικής κανάτας διατήρησης θερμότητας από ανοξείδωτο χάλυβα στη θέση αφαίρεσης (σχ. 16) και αφαιρέστε το καπάκι. Ξεπλύνετε την κανάτα και το καπάκι.

- ☞ Τοποθετήστε το καπάκι στη θέση σερβιρίσματος (εικ. 17) στην κανάτα διατήρησης θερμότητας και βάλτε την κάτω από το στόμιο εκροής καφέ (D). Για να μπορέσετε να ωθήσετε την κανάτα διατήρησης θερμότητας, το στόμιο εκροής καφέ πρέπει να έχει μετακινηθεί εντελώς προς τα πάνω.

Ένα από τα σύμβολα για τη λειτουργία κανάτας ανάβει, ανάλογα με τον αριθμό φλιτζανιών που ήταν επιλεγμένοι την τελευταία φορά που χρησιμοποιήσατε τη λειτουργία κανάτας. Επιπλέον ανάβουν τα σύμβολα περιήγησης "<" και ">".

Ο αριθμός των φλιτζανιών που ρέουν στην κανάτα εμφανίζεται ως εξής:

☐ 4 φλιτζάνια

☐ 6 φλιτζάνια

☐ 8 φλιτζάνια

☐ 10 φλιτζάνια

- ☞ Βεβαιωθείτε ότι το δοχείο νερού είναι γεμάτο, ότι υπάρχουν αρκετοί κόκκοι καφέ στο αντίστοιχο δοχείο και ότι το δοχείο συλλογής υπολειμμάτων καφέ είναι άδειο, για να μπορέσετε να ετοιμάσετε μια σειρά καφέδων στην κανάτα.

- ☐ Αν θέλετε να αλλάξετε τη γεύση καφέ και την ποσότητα πλήρωσης για τη λειτουργία κανάτας, χρησιμοποιήστε ένα από τα περιστροφικά κουμπιά "Μέγεθος φλιτζανιού" (εικόνα 12) ή "Γεύση καφέ" (εικόνα 13) αντίστοιχα, όπως περιγράφεται στην ενότητα „Παρασκευή καφέ με κόκκους“ Σελίδα 305.

- ☞ Επιλέξτε κατά περίπτωση με τα πλήκτρα περιήγησης "<" ή ">" το σύμβολο που αντιστοιχεί στον αριθμό φλιτζανιών καφέ που θέλετε να ετοιμάσετε στην κανάτα, π.χ. ☐ για 8 φλιτζάνια.

- ☞ Πατήστε το πλήκτρο "Κανάτα" ☐ (εικόνα 18).

GR

Κατά τη διάρκεια της παρασκευής καφέ αναβοσβήνει το σύμβολο κανάτας για τον επιλεγμένο αριθμό φλιτζανιών.

Όταν ο καφές είναι έτοιμος, αναβοσβήνουν διαδοχικά όλα τα σύμβολα κανάτας, ενώ το σύμβολο που αντιστοιχεί στον επιλεγμένο αριθμό φλιτζανιών ανάβει για διπλάσιο χρόνο από τα υπόλοιπα σύμβολα.

- ☞ Αφαιρέστε τώρα την κανάτα διατήρησης θερμότητας και κλείστε το καπάκι (σχ. 19) για να διατηρήσετε τον καφέ ζεστό για αρκετή ώρα.

Η συσκευή επιστρέφει αυτόματα στον τρόπο λειτουργίας παρασκευής καφέ.

- i** Αν δεν υπάρχουν αρκετοί κόκκοι καφέ ή αρκετό νερό στο δοχείο νερού ώστε να μπορεί να ολοκληρωθεί η επιθυμητή λειτουργία, ή ακόμα αν το δοχείο συλλογής υπολειμμάτων καφέ είναι γεμάτο, η συσκευή διακόπτει τη διαδικασία και το τρέχον πρόγραμμα. Το τρέχον πρόγραμμα διακόπτεται. Μετά την αντιμετώπιση του προβλήματος, το πρόγραμμα πρέπει να εκκινηθεί και πάλι. Γι' αυτόν το σκοπό, η ποσότητα καφέ που βρίσκεται ήδη στην κανάτα πρέπει να ληφθεί υπόψη, έτσι ώστε η κανάτα να μην ξεχειλίζει.

- i** Όταν αναβοσβήνουν τα σύμβολα ☞ και ▲, ο καφές είναι υπερβολικά ψιλοαλεσμένος. Συνιστούμε να αλλάξετε τη ρύθμιση του βαθμού αλέσματος, βλέπε „Ρύθμιση βαθμού αλέσματος” Σελίδα 311.

## 8 Ετοιμασία καφέ με σκόνη

Με αυτήν τη λειτουργία μπορείτε να χρησιμοποιήσετε ήδη αλεσμένο καφέ, π.χ. ντεκαφεϊνέ, για την παρασκευή.

- !** Προσοχή! Βεβαιωθείτε ότι δεν έμεινε αλεσμένος καφές στη θήκη πλήρωσης και προσέξτε να μην εισέλθουν ξένα σώματα. Η θήκη πλήρωσης δεν προορίζεται για χώρος αποθήκευσης, ο αλεσμένος καφές πρέπει να φτάνει απευθείας στη μονάδα παρασκευής.

- ☞ Γυρίστε το περιστροφικό κουμπί "Γεύση καφέ / αλεσμένος καφές" (εικόνα 20) στην επιθυμητή θέση ☞ (για 1 φλιτζάνι) ή ☞☞ (για 2 φλιτζάνια), για την επιλογή της λειτουργίας για αλεσμένο καφέ. Με αυτόν τον τρόπο, ο μύλος καφέ τίθεται εκτός λειτουργίας. Ανάβει ένα σύμβολο ☞ (για 1 φλιτζάνι) ή και τα δύο σύμβολα ☞☞ (για 2 φλιτζάνια).

- ☞ Ανοίξτε το καπάκι της θήκης πλήρωσης αλεσμένου καφέ και προσθέστε τον φρεσκοαλεσμένο καφέ (εικόνα 21).

Χρησιμοποιείτε μόνο τη μεζούρα που περιλαμβάνεται στη συσκευασία. Μη βάζετε ποτέ περισσότερο από 2 κοφτές μεζούρες, γιατί διαφορετικά είτε η συσκευή δεν θα παρασκευάσει καφέ, είτε ο αλεσμένος καφές θα σκορπιστεί στη συσκευή και θα τη λερώσει, ή ο καφές θα πέφτει σε σταγόνες και θα αναβοσβήνουν τα σύμβολα ☞☞ και ▲.

Κατά τη διάρκεια της διαδικασίας παρασκευής μη συμπληρώνετε αλεσμένο καφέ. Προσθέστε τον αλεσμένο καφέ για το επόμενο φλιτζάνι μόνον αφού ολοκληρωθεί η διαδικασία παρασκευής και η συσκευή είναι και πάλι έτοιμη. Ποτέ μη βάζετε αλεσμένο καφέ με τη μηχανή απενεργοποιημένη, γιατί στην περίπτωση αυτή διασκορπίζεται στο εσωτερικό της συσκευής.



- !** Χρησιμοποιείτε μόνο καφέ για αυτόματες μηχανές εσπρέσο. Μην προσθέτετε κόκκους καφέ, υδροδιαλυτά ή λυοφιλιωμένα στιγμιαία προϊόντα καθώς και άλλα

ροφήματα σε σκόνη στη θήκη πλήρωσης. Ο πολύ λεπτός αλεσμένος καφές μπορεί να οδηγήσει σε απόφραξη.







- i** Σε περίπτωση απόφραξης της θήκης πλήρωσης (λόγω υγρασίας στη συσκευή ή επειδή έχουν εισαχθεί περισσότερες από 2 μεζούρες αλεσμένου καφέ), χρησιμοποιήστε ένα μαχαίρι ή το στέλεχος ενός κουταλιού για να σπρώξετε τη σκόνη προς τα κάτω (εικόνα 22). Στη συνέχεια αφαιρέστε τη μονάδα παρασκευής και καθαρίστε τη μαζί με την καφετιέρα όπως περιγράφεται στην ενότητα „Καθαρισμός της μονάδας παρασκευής” Σελίδα 314”.

 Κλείστε το καπάκι.

 Επιλέξτε το μέγεθος φλιτζανιού που επιθυμείτε με το περιστροφικό κουμπί “Μέγεθος φλιτζανιού” (εικόνα 12) όπως περιγράφεται στην ενότητα „Παρασκευή καφέ με κόκκους” Σελίδα 305.

 Πατήστε το πλήκτρο “1 φλιτζάνι καφέ”  για να ετοιμάσετε ένα φλιτζάνι, ή το πλήκτρο “2 φλιτζάνια”  για 2 φλιτζάνια.

Η παρασκευή καφέ ξεκινάει.

- i** Αν είναι επιλεγμένη η λειτουργία αλεσμένου καφέ για 1 φλιτζάνι και δεν έχει προστεθεί αλεσμένος καφές στην αντίστοιχη θήκη πλήρωσης, μετά το πάτημα του πλήκτρου  αναβοσβήνουν τα σύμβολα  και . Αν είναι επιλεγμένη η λειτουργία αλεσμένου καφέ για 2 φλιτζάνια και δεν έχει προστεθεί αλεσμένος καφές στην αντίστοιχη θήκη πλήρωσης, μετά το πάτημα του πλήκτρου  αναβοσβήνουν τα σύμβολα  και .

- i** Για να επιστρέψετε μετά την παρασκευή στον τρόπο λειτουργίας για κόκκους καφέ, γυρίστε το περιστροφικό κουμπί “Γεύση καφέ / αλεσμένος καφές”

(εικόνα 20) σε μια οποιαδήποτε ρύθμιση γεύσης καφέ (η λειτουργία του μύλου καθίσταται και πάλι εφικτή).



## 9 Αφρόγαλα

Μπορείτε να χρησιμοποιήσετε τον ατμό για να ετοιμάσετε αφρόγαλα, καθώς και για να ζεστάνετε υγρά. Δεδομένου ότι για τη δημιουργία ατμού απαιτείται υψηλότερη θερμοκρασία από ότι για την παρασκευή καφέ, η συσκευή διαθέτει έναν επιπλέον τρόπο λειτουργίας με ατμό.

- i** Για μία μερίδα καπουτσίνο γεμίστε ένα μεγάλο φλιτζάνι κατά 1/2 έως 2/3 με εσπρέσσο και προσθέστε το αφρόγαλα.

 Προσοχή! Κίνδυνος εγκαυμάτων όταν είναι ενεργοποιημένο το ακροφύσιο ατμού! Το καυτό νερό και ο καυτός ατμός που εξέρχονται μπορούν να προκαλέσουν εγκαύματα. Για αυτόν το λόγο ενεργοποιείτε το ακροφύσιο ατμού μόνον αφού έχει βυθιστεί στο γάλα.

-  Για την προετοιμασία του ατμού πιάστε το πλήκτρο “Ατμός” (εικόνα 23).

Ανάβει το σύμβολο  και η συσκευή προθερμαίνεται. Κατά τη διάρκεια της προθέρμανσης αναβοσβήνει το σύμβολο . Όταν ολοκληρωθεί η προθέρμανση το σύμβολο  ανάβει μόνιμα. Η συσκευή είναι έτοιμη για τη δημιουργία αφρογάλακτος.

- i** Εάν η λειτουργία ατμού δεν χρησιμοποιηθεί για περισσότερο από 2 λεπτά, η συσκευή επανέρχεται αυτόματα στον τρόπο λειτουργίας παρασκευής καφέ.

- i** Για να αποφύγετε την ανάμιξη υπολειμμάτων νερού στο γάλα όταν παρασκευάζετε αφρόγαλα, πρέπει προηγουμένως να

GR



αδειάσετε το νερό. Για το σκοπό αυτό κρατήστε ένα δοχείο κάτω από το ακροφύσιο ατμού και στρέψτε το περιστροφικό κουμπί ατμού και ζεστού νερού (εικόνα 10) στη θέση , μέχρι να αρχίσει να βγαίνει ατμός. Στη συνέχεια στρέψτε τον επιλογέα ξανά στη θέση ●.

-  Προσθέστε άπαχο, κρύο γάλα σε ένα δοχείο που να χωράει κάτω από το ακροφύσιο ατμού της συσκευής.

-  Το γάλα συνιστάται να είναι αρκετά κρύο. Επίσης συνιστάται να χρησιμοποιήσετε ένα κρύο δοχείο, κατά προτίμηση από ανοξείδωτο ατσάλι, το οποίο δεν θα έχετε ξεπλύνει προηγουμένως με ζεστό νερό.

-  Στρέψτε το ακροφύσιο ατμού προς τα έξω και κρατήστε το κύπελλο κάτω από το ακροφύσιο ατμού με τέτοιο τρόπο, ώστε το στόμιό του να βυθίζεται μόλις στο γάλα (εικ. 24).

-  **Προσοχή!** Κίνδυνος από ακαθαρσίες από αποξηραμένο γάλα μέσα στο ακροφύσιο ατμού. Προσέξτε να μην βυθίσετε το ακροφύσιο ατμού τόσο βαθιά μέσα στο γάλα, ώστε να καλυφτεί με γάλα το άνοιγμα εισαγωγής αέρα στο άνω άκρο του ακροφυσίου ατμού. Μπορεί να εισέλθει γάλα μέσα στο ακροφύσιο με αποτέλεσμα να δημιουργηθούν ακαθαρσίες εντός του ακροφυσίου.



-  Στρέψτε το περιστροφικό κουμπί ατμού και ζεστού νερού (εικόνα 9) στη θέση . Το γάλα σχηματίζει αφρό.

-  Για να επιτύχετε πιο κρεμώδη υφή στο αφρόγαλα, κινήστε αργά το δοχείο από κάτω προς τα πάνω. Δημιουργήστε αφρόγαλα μέχρι να διπλασιαστεί τουλάχιστον ο όγκος.



-  Συνιστάται να μην παράγετε ατμό για περισσότερο από 2 λεπτά χωρίς διακοπή.

-  Για να διακόψετε τη δημιουργία αφρού, στρέψτε το περιστροφικό κουμπί ατμού και ζεστού νερού (εικόνα 9) στη θέση ● και στη συνέχεια απομακρύνετε το δοχείο.

-  **Προσοχή!** Υπάρχει κίνδυνος εγκαύματος από πιπιλιές καυτού γάλακτος! Απενεργοποιήστε τον ατμό προτού απομακρύνετε το δοχείο με το αφρόγαλα.

-  Εγκαταλείψτε τον τρόπο λειτουργίας ατμού πιέζοντας το πλήκτρο "Ατμός"  (εικόνα 23) ή περιμένετε περ. 120 δευτερόλεπτα, μέχρι η συσκευή να επιστρέψει αυτόματα στον τρόπο λειτουργίας παρασκευής καφέ.

Η συσκευή είναι ξανά έτοιμη για την παρασκευή καφέ.

-  Αφήνετε πάντα μετά τη δημιουργία αφρογάλακτος να περάσει λίγο καυτό νερό από το ακροφύσιο, στρέφοντας το περιστροφικό κουμπί ατμού και ζεστού νερού (εικόνα 10) στη θέση .

Αυτό είναι απαραίτητο, προκειμένου να μην στεγνώσουν τα υπολείμματα γάλακτος στο εσωτερικό του ακροφυσίου και το φράξουν. Χρησιμοποιείτε για το σκοπό αυτόν ένα κατάλληλο δοχείο συλλογής. Κατά τη διαδικασία αυτή ανάβει το σύμβολο .

-  Στη συνέχεια ρυθμίστε το περιστροφικό κουμπί ατμού και ζεστού νερού ξανά στη θέση ●, στην οθόνη εμφανίζεται η τελευταία επιλεγμένη ρύθμιση παρασκευής καφέ.

## 9.1 Καθαρίστε το ακροφύσιο ατμού

**Σημαντικό:** Για λόγους υγιεινής συνιστάται η εκτέλεση της διαδικασίας που περιγράφεται παρακάτω μετά από κάθε φορά που δημιουργείτε αφρόγαλα. Με

αυτόν τον τρόπο αποφεύγετε την εναπόθεση γάλακτος στο εσωτερικό του ακροφυσίου ατμού.

- ☞ Στρέψτε το περιστροφικό κουμπί ατμού και ζεστού νερού προς τα δεξιά μέχρι να τερματίσει στη θέση ●. Περιμένετε λίγα λεπτά, μέχρι να κρυώσει το ακροφύσιο ατμού.
- ☞ Στη συνέχεια κρατήστε το περιστρεφόμενο ακροφύσιο από τη μαύρη λαβή και ανοίξτε το λογχοειδή σύνδεσμο περιστρέφοντάς τον ελαφρώς δεξιόστροφα. Βγάλτε το ακροφύσιο ατμού τραβώντας το προς τα κάτω (εικ. 25).
- ☞ Βγάλτε το εσωτερικό τμήμα του ακροφυσίου ατμού από τον περιστρεφόμενο σωλήνα τραβώντας το προς τα κάτω.
- ☞ Καθαρίστε το ακροφύσιο ατμού και το εσωτερικό τμήμα με ζεστό νερό.
- ☞ Βεβαιωθείτε ότι οι δύο σπές που επισημαίνονται στην εικόνα 26 δεν είναι βουλωμένες. Αν χρειάζεται, τρυπήστε με μια βελόνα και καθαρίστε.
- ☞ Τοποθετήστε και πάλι το εσωτερικό τμήμα, ωθώντας το προσεκτικά στον περιστρεφόμενο σωλήνα.
- ☞ Τοποθετήστε και πάλι το ακροφύσιο ατμού, ωθώντας το ξανά και γυρίζοντάς το αριστερόστροφα.

## 10 Παρασκευή ζεστού νερού

Το ζεστό νερό μπορεί να χρησιμοποιηθεί για το ζέσταμα των φλιτζανιών και για την παρασκευή ζεστών ροφημάτων, π.χ. τσάι ή έτοιμες σούπες.

- ⚠ Προσοχή! Κίνδυνος εγκαυμάτων όταν είναι ενεργοποιημένο το ακροφύσιο ζεστού νερού! Το ζεστό νερό που εξέρχεται μπορεί να προκαλέσει εγκαύματα. Ενεργοποιείτε το ακροφύσιο ζεστού νερού μόνο όταν βρίσκεται ένα δοχείο από κάτω.

☞ Τοποθετήστε ένα δοχείο κάτω από το ακροφύσιο ζεστού νερού.

☞ Στρέψτε το περιστροφικό κουμπί ατμού και ζεστού νερού στη θέση ☺ (εικ. 10). Εκκρέει ζεστό νερό και ανάβει το σύμβολο ☺.

ⓘ Συνιστάται να μην παράγετε ζεστό νερό για περισσότερο από 2 λεπτά χωρίς διακοπή.

☞ Μετά τη λήψη του ζεστού νερού, επαναφέρετε το περιστροφικό κουμπί ατμού και ζεστού νερού στη θέση ● (εικόνα 10) και αφαιρέστε το δοχείο.

## 11 Ρύθμιση βαθμού αλέσματος

Ο μύλος είναι ρυθμισμένος από το εργοστάσιο στη μεσαία βαθμό αλέσματος. Αν η εκροή καφέ είναι πολύ γρήγορη ή πολύ αργή (σταγόνες), μπορείτε να αλλάξετε το βαθμό αλέσματος κατά τη διάρκεια της διαδικασίας αλέσματος.

⚠ **Ο βαθμός αλέσματος επιτρέπεται να τροποποιηθεί μόνο κατά τη διάρκεια του αλέσματος. Αυτό σημαίνει ότι μπορείτε να γυρίσετε το κουμπί για τη ρύθμιση του βαθμού αλέσματος (εικόνα 2, T και εικόνα 27), μόνο στο διάστημα που ο μύλος αλέθει κόκκους καφέ κατά τη διάρκεια της παρασκευής καφέ. Οι ρυθμίσεις σε ακινητοποιημένο μύλο μπορεί να προκαλέσουν ζημιές στην καφετιέρα.**

- ☞ Ρυθμίστε το βαθμό αλέσματος με το κουμπί για τη ρύθμιση βαθμού αλέσματος (εικ. 2, T) (εικ. 27).
  - Αν ο καφές εκκρέει σε σταγόνες ή δεν εκκρέει όλη η ποσότητα, (μπορεί να αναβοσβήνουν τα σύμβολα ☺ και ☺), το κουμπί πρέπει να περιστραφεί κατά μία θέση προς τα δεξιά. Στρέψτε το κουμπί κατά μία θέση

GR

κάθε φορά, μέχρις ότου να επιτευχθεί η επιθυμητή εκροή καφέ.

- Αν ο καφές εκρέει πολύ γρήγορα και το καϊμάκι δεν είναι ικανοποιητικό για τις προτιμήσεις σας, στρέψτε το κουμπί κατά μία θέση προς τα αριστερά.

**i** Προσέξτε να μη γυρίσετε υπερβολικά το κουμπί για τη ρύθμιση του βαθμού αλέσματος, γιατί διαφορετικά, αν παρασκευάζετε 2 φλιτζάνια, ο καφές ενδέχεται να εκρέει σταγόνα-σταγόνα.

**i** Ωστόσο, η επίδραση αυτών των διορθώσεων γίνεται αντιληπτή μόνο μετά από 2 τουλάχιστον παρασκευές καφέ.

#### Απομάκρυνση ξένων σωμάτων από το μύλο

Τα ξένα σώματα εντός του μύλου όπως π.χ. πετραδάκια μπορούν να προκαλέσουν ζημιές στο μύλο. Η ύπαρξη ξένου σώματος στον καφέ προκαλεί ένα συνεχή δυνατό κρότο. Αν κατά τη διάρκεια του αλέσματος ακουστεί ο συγκεκριμένος ήχος, απενεργοποιήστε αμέσως τη συσκευή και απευθυνθείτε στο τμήμα εξυπηρέτησης πελατών. **Το μπλοκάρισμα ή η πρόκληση ζημιάς στο μύλο λόγω της παρουσίας ξένου σώματος, ενδέχεται να μην καλύπτεται από την εγγύηση.**

## 12 Ρύθμιση θερμοκρασίας καφέ

Μπορείτε να επιλέξετε μεταξύ τριών βαθμίδων θερμοκρασίας. Η εργοστασιακή ρύθμιση είναι "Θερμοκρασία υψηλή". Τη ρύθμιση αυτή μπορείτε να την αλλάξετε ως εξής:

**☞** Πατήστε το πλήκτρο "P" (εικόνα 4). Ανάβουν τα σύμβολα "P" και ☞. Επιπλέον ανάβουν τα 3 μικρά σύμβολα πάνω από τα πλήκτρα ☞, ☞ και ☞, για να δηλώσουν τη λειτουργία των συγκεκριμένων πλήκτρων τη δεδομένη στιγμή, βλέπε „Ειδικός τρόπος λειτουργίας“ Σελίδα 301.

**☞** Πατήστε επανειλημμένα τα πλήκτρα περιήγησης "<" ή ">" (εικόνα 5) μέχρι να ανάψει το σύμβολο ↓.

**☞** Επιβεβαιώστε με το πλήκτρο "OK" (εικόνα 5).

Στην οθόνη εμφανίζεται η τρέχουσα ρύθμιση. Οι θερμοκρασίες εμφανίζονται ως εξής:

☞ ☞ ☞ θερμοκρασία χαμηλή

☞ ☞ ☞ θερμοκρασία μέτρια

☞ ☞ ☞ θερμοκρασία μέτρια

**☞** Κατά περίπτωση, επιλέξτε με τα πλήκτρα περιήγησης "<" ή ">" (εικ. 5) μια άλλη θερμοκρασία.

**☞** Όταν εμφανιστεί η επιθυμητή θερμοκρασία, επιβεβαιώστε την με το πλήκτρο "OK" (εικόνα 5). Με τον τρόπο αυτό προγραμματίζεται η συγκεκριμένη θερμοκρασία.

**i** Για να διακόψετε χωρίς να αποθηκεύσετε, πατήστε το πλήκτρο "P" αντί για το "OK".

**i** Εάν το "OK" δεν πατηθεί, η συσκευή επιστρέφει αυτόματα, μετά από 120 δευτερόλεπτα περίπου, στον τρόπο λειτουργίας παρασκευής καφέ, χωρίς να γίνει αποθήκευση των ρυθμίσεων.









**☞** Για επιστροφή στον τρόπο λειτουργίας παρασκευής καφέ, πατήστε στη συνέχεια το πλήκτρο "P" (εικόνα 4) ή περιμένετε περ. 120 δευτ., ωστόσο η συσκευή επιστρέφει αυτόματα στον τρόπο λειτουργίας παρασκευής καφέ.





## 13 Καθαρισμός και φροντίδα

Διατηρείτε τη συσκευή σας καθαρή για να εξασφαλίσετε μια σταθερή ποιότητα καφέ και την άψογη λειτουργία της συσκευής.

### 13.1 Τακτικός καθαρισμός





-  **Προσοχή!** Απενεργοποιήστε τη συσκευή πριν τον καθαρισμό. Αφήστε τη συσκευή να κρυώσει.
-  **Προσοχή!** Σε καμία περίπτωση μην τοποθετείτε τη συσκευή ή μεμονωμένα τμήματά της μέσα στο πλυντήριο πιάτων. Ποτέ μη βυθίζετε την καφετιέρα στο νερό.
-  **Προσοχή!** Μην ρίχνετε ποτέ νερό στο δοχείο κόκκων, καθώς μπορεί να υποστεί ζημιές ο μύλος.
-  Μην χρησιμοποιείτε καθαριστικά που χαράζουν καθώς και λειαντικά ή καυστικά απορρυπαντικά. Καθαρίζετε το περίβλημα της συσκευής μέσα και έξω μόνο με υγρό πανί.
-  Αφαιρείτε καθημερινά το δοχείο νερού (εικόνα 6) και αδειάζετε το υπολειπόμενο νερό. Ξεπλένετε το δοχείο νερού με φρέσκο νερό. Χρησιμοποιείτε καθημερινά φρέσκο νερό.
-  Αδειάζετε το δοχείο συλλογής υπολειμμάτων καφέ καθημερινά ή το αργότερο όταν δείτε τη σχετική προτροπή στην οθόνη, βλέπε „Αδειασμα δοχείου συλλογής υπολειμμάτων καφέ“ Σελίδα 313.
-  Αδειάζετε τακτικά το δοχείο στράγγισης. Αδειάστε το δοχείο στράγγισης το αργότερο όταν ο κόκκινος πλωτήρας του δοχείου στράγγισης (εικόνα 28) γίνει ορατός από το άνοιγμα στη σχάρα στράγγισης.
-  Καθαρίζετε τακτικά, τουλάχιστον μία φορά την εβδομάδα, το δοχείο νερού (N), το δοχείο στράγγισης (O), τη σχάρα στράγγισης (A) και το δοχείο συλλογής υπολειμμάτων

καφέ (Q) με χλιαρό νερό, απαλό απορρυπαντικό και, εάν χρειαστεί, με πινέλο.

-  Μετά από κάθε δημιουργία αφρογάλακτος αφαιρείτε το ακροφύσιο ατμού και καθαρίζετε το διεξοδικά από υπολείμματα γάλακτος, βλ. „Καθαρίστε το ακροφύσιο ατμού“ Σελίδα 310.
-  Βεβαιωθείτε ότι τα ανοίγματα εκροής καφέ δεν είναι αποφραγμένα. Για καθαρίσμα μπορείτε να αφαιρέσετε τα ξεραμένα υπολείμματα καφέ με μια βελόνα (εικόνα 29).

### 13.2 Άδειασμα δοχείου συλλογής υπολειμμάτων καφέ

Μετά από παρασκευή 14 μεμονωμένων (ή 7 διπλών) καφέδων ανάβει το σύμβολο , επισημαίνοντας ότι το δοχείο συλλογής υπολειμμάτων καφέ είναι γεμάτο και πρέπει να αδειάσει για να καθαριστεί. Μέχρι να καθαριστεί το δοχείο συλλογής υπολειμμάτων καφέ, η καφετιέρα δεν μπορεί να παρασκευάσει άλλο καφέ.

-  Για τον καθαρισμό απασφαλίστε και ανοίξτε το πορτάκι σέρβις πατώντας το αντίστοιχο κουμπί ανοίγματος (εικόνα 30), το σύμβολο  ανάβει.
-  Στη συνέχεια αφαιρέστε το δοχείο στράγγισης (εικόνα 31), αδειάστε το και καθαρίστε το.
-  Αδειάστε και καθαρίστε προσεκτικά το δοχείο συλλογής υπολειμμάτων καφέ. Προσέξτε να απομακρυνθούν όλα τα κατάλοιπα που έχουν εναποτεθεί στη βάση.  
**Σημαντικό:** Κάθε φορά που αφαιρείτε το δοχείο στράγγισης, **πρέπει** να καθαρίζετε και το δοχείο συλλογής υπολειμμάτων καφέ, ακόμη κι αν δεν είναι εντελώς γεμάτο. Αν δεν εκτελέσετε αυτήν τη διαδικασία, ενδέχεται τις επόμενες φορές που θα παρασκευάσετε καφέ, το δοχείο συλλογής

GR

υπολειμμάτων καφέ να υπερχειλίσει και η πλεονάζουσα ποσότητα καφέ να προκαλέσει την απόφραξη της καφετιέρας.

**i** Όταν έχετε αφαιρέσει το δοχείο στράγγισης, αναβοσβήνει το σύμβολο .

**i** Εφόσον χρησιμοποιείτε τη συσκευή καθημερινά, πρέπει να αδειάζετε και το δοχείο καθημερινά. Αδειάζετε το δοχείο συλλογής υπολειμμάτων καφέ πάντοτε με ενεργοποιημένη τη συσκευή. Μόνο τότε η συσκευή αναγνωρίζει το άδειασμα.

### 13.3 Καθαρισμός του μύλου

Τα υπολείμματα αλεσμένου καφέ μπορούν να αφαιρεθούν από το δοχείο κόκκων με ένα μαλακό πινέλο ή με ηλεκτρική σκούπα.

**!** Προσοχή! Μη ρίχνετε ποτέ νερό στο μύλο, καθώς μπορεί να υποστεί ζημιές.

**☞** Θέστε τη συσκευή σε λειτουργία με το πλήκτρο "On/Off" (εικόνα 11) και το γενικό διακόπτη (εικόνα 8). Τραβήξτε το ρευματολήπτη.

**☞** Απομακρύνετε τα υπολείμματα κόκκων καφέ (χρησιμοποιήστε π.χ. ηλεκτρική σκούπα με εύκαμπτο σωλήνα ή πλακέ απορροφητήρα).

**i** Σε περίπτωση που δεν μπορείτε να απομακρύνετε κάποιο ξένο σώμα, πρέπει να απευθυνθείτε στο τμήμα εξυπηρέτησης πελατών. **Το μπλοκάρισμα ή η πρόκληση ζημιών στο μύλο λόγω της παρουσίας ξένου σώματος, ενδέχεται να μην καλύπτεται από την εγγύηση.**

**!** Προσοχή! Κίνδυνος τραυματισμού από τον περιστρεφόμενο μύλο. Ποτέ μην θέτετε τη συσκευή σε λειτουργία ενώ εκτελείτε εργασίες στο μύλο. Μπορούν να προκληθούν σοβαροί

τραυματισμοί. Τραβήξτε οπωσδήποτε το ρευματολήπτη.

**☞** Ελέγξτε με μία μικρή ποσότητα κόκκων τη λειτουργία του μύλου, παρασκευάζοντας έναν καφέ. Στο πρώτο άλεσμα ή μετά τον καθαρισμό μεταφέρεται λιγότερος αλεσμένος καφές στη μονάδα παρασκευής, διότι πρέπει να πληρωθεί ο σωλήνας. Αυτό μπορεί να επηρεάσει την ποιότητα του πρώτου καφέ.

### 13.4 Καθαρισμός της μονάδας παρασκευής

Συνιστούμε να καθαρίζετε τακτικά τη μονάδα παρασκευής (ανάλογα με τη συχνότητα χρήσης). Σε περίπτωση παρατεταμένης παύσης λειτουργίας της συσκευής (π.χ. όταν φεύγετε για διακοπές), είναι απαραίτητο να αδειάζετε το δοχείο συλλογής υπολειμμάτων καφέ και το δοχείο νερού και να καθαρίζετε καλά τη συσκευή, συμπεριλαμβανομένης της μονάδας παρασκευής.

Ακολουθήστε την εξής διαδικασία:

**☞** Με πάτημα του πλήκτρου On/Off (εικόνα 11) απενεργοποιήστε τη καφετιέρα (μη βγάξετε το βύσμα) και περιμένετε μέχρι να σβήσουν όλα τα σύμβολα!

**☞** Απασφαλίστε το πορτάκι σέρβις με πάτημα στο αντίστοιχο κουμπί ανοίγματος και ανοίξτε το (εικόνα 30).

**☞** Αφαιρέστε το δοχείο στράγγισης και το δοχείο συλλογής υπολειμμάτων καφέ (εικόνα 31) και καθαρίστε τα.

**☞** Πιέστε τα δύο κόκκινα πλήκτρα απασφάλισης της μονάδας παρασκευής στα πλάγια και προς το κέντρο (εικόνα 32) και τραβήξτε έξω τη μονάδα παρασκευής.

**i** Προσοχή: Η μονάδα παρασκευής μπορεί να αφαιρεθεί μόνο όταν η συσκευή έχει απενεργοποιηθεί με το

**πλήκτρο On/Off ① στην μπροστινή πλευρά της συσκευής. Η συσκευή δεν πρέπει να αποσυνδεθεί από το ρεύμα. Αν επιχειρήσετε να αφαιρέσετε τη μονάδα παρασκευής με ενεργοποιημένη την καφετιέρα, η καφετιέρα μπορεί να υποστεί σοβαρές ζημιές.**

- ☞ Καθαρίζετε τη μονάδα με τρεχούμενο νερό βρύσης, χωρίς τη χρήση απορρυπαντικών. **Ποτέ μην πλένετε τη μονάδα παρασκευής στο πλυντήριο πιάτων.**
- ☞ Καθαρίζετε προσεκτικά το εσωτερικό της μηχανής. Τα ξεραμένα υπολείμματα καφέ στην καφετιέρα θα πρέπει να αφαιρούνται με ξύσιμο (εικόνα 33) με ένα ξύλινο ή πλαστικό πιρούνι ή κάτι παρόμοιο που να μην προκαλεί γρατζουνιές στην επιφάνεια, και στη συνέχεια να αναρροφώνται με ηλεκτρική σκούπα (εικόνα 34).
- ☞ Για την επανατοποθέτηση, ωθήστε τη μονάδα παρασκευής (εικόνα 36, a) στη βάση (εικόνα 36, b) και τον αξονίσκο (εικόνα 36, c). Ο αξονίσκος πρέπει να εισαχθεί στο σωλήνα (εικόνα 36, d) που υπάρχει στο κάτω μέρος της μονάδας παρασκευής.
- ☞ Πατήστε τώρα σταθερά στην επιγραφή PUSH (εικόνα 36, e) μέχρι να ασφαλίσει η μονάδα παρασκευής.
- ☞ Αφού ακούσετε το κλικ της ασφάλισης, βεβαιωθείτε ότι τα κόκκινα πλήκτρα (εικόνα 36, f) έχουν πεταχτεί προς τα έξω, διαφορετικά το πορτάκι σέρβις δεν μπορεί να κλείσει.  
Εικόνα 37: Τα δύο κόκκινα πλήκτρα έχουν πεταχτεί σωστά προς τα έξω.  
Εικόνα 38: Τα δύο κόκκινα πλήκτρα δεν έχουν πεταχτεί προς τα έξω.

☞ Τοποθετήστε ξανά το δοχείο στράγγισης μαζί με το δοχείο συλλογής υπολειμμάτων καφέ.

☞ Κλείστε το πορτάκι σέρβις.

**i** Αν η μονάδα παρασκευής δεν έχει τοποθετηθεί σωστά, δηλαδή μέχρι να ακουστεί το κλικ της ασφάλισης, και τα κόκκινα πλήκτρα δεν έχουν πεταχτεί σωστά προς τα έξω, το καπάκι σέρβις δεν μπορεί να κλείσει.

**i** Αν η μονάδα παρασκευής δεν τοποθετείται με ευκολία, θα πρέπει (πριν από την τοποθέτηση) να έρθει στο σωστό ύψος, με σταθερή πίεση της μονάδας ταυτόχρονα από κάτω και από πάνω, όπως φαίνεται στην εικόνα 35.

**i** Αν η τοποθέτηση της μονάδας παρασκευής εξακολουθεί να είναι δύσκολη, κλείστε το πορτάκι σέρβις, τραβήξτε το βύσμα του καλωδίου παροχής ρεύματος από την πρίζα, και ξαναβάλτε το. Περιμένετε μέχρι να σβήσουν όλα τα σύμβολα, και στη συνέχεια ανοίξτε το πορτάκι σέρβις και βάλτε πάλι τη μονάδα παρασκευής στη θέση.

### 13.5 Εκτέλεση προγράμματος αφαλάτωσης

Το πρόγραμμα αφαλάτωσης επιτρέπει την εύκολη και αποτελεσματική αφαίρεση των αλάτων από τη συσκευή σας. Όταν ανάβει το σύμβολο  αυτό σημαίνει ότι η συσκευή πρέπει να αφαλατωθεί.

**!** **Προσοχή:** Σε καμία περίπτωση μη χρησιμοποιείτε μέσα αφαλάτωσης που δεν συνιστώνται από την AEG/Electrolux. Σε περίπτωση χρήσης άλλων μέσων αφαλάτωσης, η AEG/Electrolux δεν αναλαμβάνει καμία ευθύνη για τυχόν ζημιές. Υγρά αφαιρέσεις αλάτων μπορείτε να προμηθευτείτε από εξειδικευμένα καταστήματα ή καλώντας τη γραμμή εξυπηρέτησης AEG/Electrolux.

GR

**i** Η διαδικασία αφαίρεσης αλάτων διαρκεί περίπου 45 λεπτά και δεν πρέπει να διακόπτεται. Σε περίπτωση διακοπής ρεύματος το πρόγραμμα πρέπει να ξεκινήσει πάλι από την αρχή!

➔ Προτού ξεκινήσετε το πρόγραμμα αφαλάτωσης, καθαρίστε τη μονάδα παρασκευής (βλέπε „Καθαρισμός της μονάδας παρασκευής” Σελίδα 314).

➔ Πατήστε το πλήκτρο "P" (εικόνα 4). Ανάβουν τα σύμβολα "P" και ☐. Επιπλέον ανάβουν τα 3 μικρά σύμβολα πάνω από τα πλήκτρα ☐, ☐ και ☐, για να δηλώσουν τη λειτουργία των συγκεκριμένων πλήκτρων τη δεδομένη στιγμή, βλέπε „Ειδικός τρόπος λειτουργίας” Σελίδα 301.

➔ Πατήστε επανειλημμένα τα πλήκτρα περιήγησης "< ή >" (εικόνα 5), μέχρι να ανάψει το σύμβολο ☐.

➔ Επιβεβαιώστε με το πλήκτρο "OK" (εικόνα 5). Τα σύμβολα ☐ και ☐ αναβοσβήνουν και το "P" ανάβει διαρκώς.

**i** Για να διακόψετε στο σημείο αυτό το πρόγραμμα αφαλάτωσης, απενεργοποιήστε τη συσκευή με το πλήκτρο "On/Off" Ⓛ.

➔ Αδειάστε το δοχείο νερού, γεμίστε το τουλάχιστον με 1 λίτρο νερό και προσθέστε το υλικό αφαλάτωσης.

⚠ Προσοχή: Βεβαιωθείτε ότι οι ενδεχόμενες πιτσιλιές υλικού αφαλάτωσης δεν θα πέσουν σε επιφάνειες ευαίσθητες στα οξέα, όπως είναι οι μαρμάρινες και οι επιφάνειες από ασβεστόλιθο και κεραμικά υλικά.

➔ Τοποθετήστε κάτω από το ακροφύσιο ατμού ένα δοχείο με χωρητικότητα τουλάχιστον 1,5 λίτρο (εικόνα 9).

➔ Στρέψτε το περιστρεφόμενο κουμπί ατμού και ζεστού νερού στη θέση ☐.

Το πρόγραμμα αφαλάτωσης ξεκινάει και το υγρό αφαλάτωσης εκρέει από το ακροφύσιο ατμού. Τα σύμβολα ☐, και ☐ "P" ανάβουν διαρκώς.

Το πρόγραμμα αφαλάτωσης διενεργεί αυτόματα μια σειρά από ξεπλύματα και παύσεις, για να αφαιρεθούν από το εσωτερικό της καφετιέρας οι εναποθέσεις αλάτων. Μετά από 30 λεπτά περίπου το δοχείο νερού έχει αδειάσει, τα σύμβολα ☐ και ☐ αναβοσβήνουν και το "P" ανάβει διαρκώς.

➔ Επαναφέρετε το περιστρεφόμενο κουμπί ατμού και ζεστού νερού στη θέση ●.

Η συσκευή είναι τώρα έτοιμη για ξέπλυμα με φρέσκο νερό.

➔ Αφαιρέστε το δοχείο νερού, γεμίστε το με καθαρό νερό και επανατοποθετήστε το.

➔ Αδειάστε το δοχείο κάτω από το ακροφύσιο ατμού και επανατοποθετήστε το κάτω από το ακροφύσιο.

➔ Στρέψτε το περιστρεφόμενο κουμπί ατμού κα ζεστού νερού στη θέση ☐.

Εκτελείται μια διαδικασία ξεπλύματος με καθαρό νερό και το νερό του ξεπλύματος τρέχει από το ακροφύσιο ατμού. Τα σύμβολα ☐, ☐ και "P" ανάβουν διαρκώς.

Μετά από μερικά λεπτά το δοχείο νερού έχει αδειάσει, τα σύμβολα ☐ και ☐ αναβοσβήνουν και το "P" ανάβει διαρκώς.

➔ Επαναφέρετε το περιστρεφόμενο κουμπί ατμού και ζεστού νερού στη θέση ●.

Εμφανίζονται τα σύμβολα που αντιστοιχούν στον τελευταίο επιλεγμένο τρόπο λειτουργίας παρασκευής καφέ και το σύμβολο ☐ ανάβει διαρκώς.

➔ Αδειάστε το δοχείο με το νερό ξεπλύματος.

- ☞ Αφαιρέστε το δοχείο νερού, γεμίστε το με καθαρό νερό και επανατοποθετήστε το.

Η συσκευή είναι ξανά έτοιμη προς λειτουργία και στην κατάσταση του τελευταίου επιλεγμένου τρόπου λειτουργίας παρασκευής καφέ.

- i Συνιστούμε να πετάτε το πρώτο φλιτζάνι καφέ που παρασκευάζετε μετά την ολοκλήρωση του προγράμματος αφαίρεσης αλάτων.

## 14 Παραγγελία εξαρτημάτων

Προκειμένου να επιμηκύνετε τη διάρκεια ζωής της συσκευής σας και να αποφύγετε πρόωρες βλάβες, είναι πολύ σημαντικό να την καθαρίζετε και να αφαιρείτε τακτικά τα άλατα. Το γνήσιο μέσο αφαίρεσης αλάτων μπορείτε να το προμηθεύσετε και απευθείας από την εταιρεία μας.

Στην Γερμανία μπορείτε να καλέσετε την ανοιχτή γραμμή παραγγελίας στο:

1801 - 20 30 60\*

(\*Αστική χρέωση από το σταθερό δίκτυο της Deutsche Telekom)  
Δευτέρα έως Παρασκευή, ώρες 8.00 - 18.00

## 15 Τι πρέπει να γίνει όταν στην οθόνη εμφανίζεται το μήνυμα...

**Το σύμβολο ☹ ανάβει διαρκώς**

- Η δεξαμενή νερού είναι κενή ή δεν είναι σωστά τοποθετημένη.
- ☞ Γεμίστε το δοχείο και τοποθετήστε το σύμφωνα με τις οδηγίες, βλ. „Πλήρωση νερού” Σελίδα 302.
- Το δοχείο νερού είναι λερωμένο ή έχουν σχηματιστεί στο εσωτερικό του εναποθέσεις αλάτων.
- ☞ Ξεπλύνετε το δοχείο νερού ή εκτελέστε αφαλάτωση.

**Τα σύμβολα ☹ και ⚠ αναβοσβήνουν**

- Η καφετιέρα δεν μπορεί να παρασκευάσει καφέ.
- ☞ Κρατήστε ένα δοχείο κάτω από το ακροφύσιο ατμού και στρέψτε το περιστροφικό κουμπί ατμού και ζεστού νερού προς τα αριστερά στη θέση ☹☹ (εικόνα 9).
- Ο καφές εκρέει πολύ αργά.
- ☞ Γυρίστε το κουμπί ρύθμισης βαθμού αλέσματος (εικόνα 12) μια θέση προς τα δεξιά, στο διάστημα που ο μύλος αλέθει κατά τη διάρκεια μιας παρασκευής καφέ (βλέπε „Ρύθμιση βαθμού αλέσματος” Σελίδα 311).

**Το σύμβολο ☹ ανάβει διαρκώς**

- Το δοχείο συλλογής υπολειμμάτων καφέ είναι πλήρες.
- ☞ Αδειάστε το δοχείο συλλογής υπολειμμάτων καφέ όπως περιγράφεται στην ενότητα „Αδειασμα δοχείου συλλογής υπολειμμάτων καφέ” Σελίδα 313, καθαρίστε το και επανατοποθετήστε το σωστά.

**Το σύμβολο ☹ αναβοσβήνει**

- Το δοχείο συλλογής υπολειμμάτων καφέ δεν έχει επανατοποθετηθεί μετά τον καθαρισμό.
- ☞ Ανοίξτε το πορτάκι σέρβις και τοποθετήστε το δοχείο συλλογής υπολειμμάτων καφέ.

**Τα σύμβολα ☹ ή ☹☹ και ⚠ αναβοσβήνουν<**

- Μετά από την επιλογή της λειτουργίας για αλεσμένο καφέ, δεν έχει εισαχθεί σκόνη καφέ στη θήκη πλήρωσης.
- ☞ Γεμίστε με σκόνη καφέ όπως περιγράφεται στην ενότητα „Ετοιμασία καφέ με σκόνη” Σελίδα 308.

GR

### Όλα τα σύμβολα για τη γεύση καφέ ☉☉☉☉☉ και ▲ αναβοσβήνουν

- Δεν υπάρχουν άλλοι κόκκοι καφέ στο δοχείο κόκκων.
- ☞ Γεμίστε το δοχείο κόκκων καφέ, βλ. „Πλήρωση δοχείου κόκκων” Σελίδα 302
- Αν ο μύλος αρχίσει να κάνει πολύ θόρυβο, αυτό σημαίνει ότι έχει φράξει από κάποιο μικρό πετραδάκι που υπάρχει μέσα στους κόκκους καφέ.
- ☞ Απευθυνθείτε στο τμήμα εξυπηρέτησης πελατών. **Το μπλοκάρισμα ή η πρόκληση ζημιάς στο μύλο λόγω της παρουσίας ξένου σώματος, ενδέχεται να μην καλύπτεται από την εγγύηση.**

### Το σύμβολο ☐ ανάβει διαρκώς

- Επισημαίνει ότι στην καφετιέρα έχουν σχηματιστεί εναποθέσεις αλάτων.
- ☞ Θα πρέπει να εκτελέσετε όσο το δυνατόν πιο γρήγορα το πρόγραμμα αφαλάτωσης που περιγράφεται στην ενότητα „Εκτέλεση προγράμματος αφαλάτωσης” Σελίδα 315.

### Το σύμβολο ☐ ανάβει διαρκώς

- Το πορτάκι σέρβις είναι ανοικτό.
- ☞ Κλείστε το πορτάκι σέρβις. Αν το πορτάκι σέρβις δεν κλείνει, βεβαιωθείτε ότι η μονάδα παρασκευής είναι σωστά τοποθετημένη (βλ. „Καθαρισμός της μονάδας παρασκευής” Σελίδα 314).

### Το σύμβολο ▲ αναβοσβήνει

- Προφανώς έχετε ξεχάσει να τοποθετήσετε και πάλι τη μονάδα παρασκευής στην καφετιέρα μετά από τον καθαρισμό.
- ☞ Τοποθετήστε τη μονάδα παρασκευής, βλέπε „Καθαρισμός της μονάδας παρασκευής” Σελίδα 314

- Το εσωτερικό της καφετιέρας είναι πολύ λερωμένο.

- ☞ Καθαρίστε προσεκτικά το εσωτερικό της μηχανής, βλέπε „Καθαρισμός της μονάδας παρασκευής” Σελίδα 314. Αν μετά από τον καθαρισμό της καφετιέρας το μήνυμα εξακολουθεί να εμφανίζεται, απευθυνθείτε στο τμήμα εξυπηρέτησης πελατών.

### Το σύμβολο ▲ ανάβει διαρκώς

- Επισημαίνοντας έναν γενικό συναγερμό.
- ☞ Απευθυνθείτε στο τμήμα εξυπηρέτησης πελατών.

### Τα σύμβολα ☘ και ▲ αναβοσβήνουν

- Η συσκευή ενεργοποιήθηκε ενώ το περιστροφικό κουμπί ατμού και ζεστού νερού βρισκόταν στη θέση “ανοιχτό” ☺☘.
- ☞ Γυρίστε το περιστροφικό κουμπί ατμού και ζεστού νερού προς τα δεξιά (εικόνα 10) μέχρι τέρμα στη θέση ●.

### Τα σύμβολa ! και ▲ αναβοσβήνουν

- Η θερμοκρασία περιβάλλοντος είναι πολύ χαμηλή, με αποτέλεσμα να μην είναι δυνατή η λειτουργία της συσκευής.
- ☞ Λειτουργήστε τη συσκευή σε έναν πιο ζεστό χώρο.

## 16 Προβλήματα που μπορούν να επιλυθούν προτού απευθυνθείτε στο τμήμα εξυπηρέτησης πελατών

Όταν η καφετιέρα δεν λειτουργεί, μπορείτε να βρείτε εύκολα την αιτία του λειτουργικού προβλήματος και να την αντιμετωπίσετε, ανατρέχοντας στο κεφάλαιο „Τι πρέπει να γίνει όταν στην οθόνη εμφανίζεται το μήνυμα...”

Σελίδα 317. Αν, αντίθετα, δεν εμφανίζεται κανένα σύμβολο στην καφετιέρα, προβείτε στους ακόλουθους ελέγχους προτού απευθυνθείτε στο τμήμα εξυπηρέτησης πελατών.

#### Ο καφές δεν είναι ζεστός

- Τα φλιτζάνια δεν έχουν προθερμανθεί.
- ☞ Προθερμάνετε τα φλιτζάνια, ξεπλένοντάς τα με ζεστό νερό ή αφήνοντάς τα τουλάχιστον για 20 λεπτά στη ζεστή βάση φλιτζανιών (H) (βλέπε „Συμβουλές για την εξαγωγή πιο ζεστού καφέ:“ Σελίδα 307).

#### Ο καφές έχει ανεπαρκή ποσότητα καΐμακιού

- Ο καφές είναι χοντροαλεσμένος.
- ☞ Γυρίστε το κουμπί ρύθμισης βαθμού αλέσματος μια θέση προς τα αριστερά, στο διάστημα που ο μύλος αλέθει κόκκους καφέ κατά τη διάρκεια μιας παρασκευής καφέ (βλέπε „Ρύθμιση βαθμού αλέσματος“ Σελίδα 311).
- Το μίγμα καφέ δεν είναι κατάλληλο.
- ☞ Χρησιμοποιήστε ένα μίγμα καφέ κατάλληλο για αυτόματες καφετιέρες.

#### Ο καφές εκρέει πολύ αργά

- Ο καφές είναι ψιλοαλεσμένος.
- ☞ Γυρίστε το κουμπί ρύθμισης βαθμού αλέσματος μια θέση προς τα δεξιά, στο διάστημα που ο μύλος αλέθει κόκκους καφέ κατά τη διάρκεια μιας παρασκευής καφέ (βλέπε „Ρύθμιση βαθμού αλέσματος“ Σελίδα 311).

#### Ο καφές εκρέει πολύ γρήγορα.

- Ο καφές είναι χοντροαλεσμένος.
- ☞ Γυρίστε το κουμπί ρύθμισης βαθμού αλέσματος μια θέση προς τα αριστερά, στο διάστημα που ο μύλος αλέθει κόκκους καφέ κατά τη διάρκεια μιας παρασκευής καφέ

(βλέπε „Ρύθμιση βαθμού αλέσματος“ Σελίδα 311).

#### Ο καφές εκρέει μόνο από μία θέση εκροής καφέ.

- Οι οπές των θέσεων εκροής καφέ είναι φραγμένες.
- ☞ Αφαιρέστε τα ξεραμένα υπολείμματα καφέ με μια βελόνα (εικόνα 29).

#### Παρά το γύρισμα του περιστροφικού κουμπιού ατμού και ζεστού νερού, δεν εξέρχεται ατμός από το ακροφύσιο ατμού.

- Οι μικρές οπές του ακροφυσίου ατμού και του εσωτερικού του είναι φραγμένες.
- ☞ Καθαρίστε τις οπές του ακροφυσίου ατμού και του εσωτερικού του (βλέπε „Καθαρίστε το ακροφύσιο ατμού“ Σελίδα 310).

#### Όταν είναι επιλεγμένη η λειτουργία ☞ ή ☞☞, δεν βγαίνει από την καφετιέρα καφές, αλλά νερό

- Η σκόνη καφέ ενδέχεται να έχει μπλοκάρει στη θήκη πλήρωσης.
- ☞ Αφαιρέστε τη σκόνη που έχει μείνει στη θήκη πλήρωσης με τη βοήθεια ενός μαχαιριού (βλ. „Ετοιμασία καφέ με σκόνη“ Σελίδα 308) (εικόνα 22). Στη συνέχεια καθαρίστε τη μονάδα παρασκευής και το εσωτερικό της καφετιέρας (βλέπε „Καθαρισμός της μονάδας παρασκευής“ Σελίδα 314)

#### Η καφετιέρα δεν ενεργοποιείται με το πάτημα του πλήκτρου ①

- Ο γενικός διακόπτης στην πίσω πλευρά της συσκευής δεν είναι ενεργοποιημένος (εικόνα 8) ή το βύσμα δεν είναι στην πρίζα.
- ☞ Βεβαιωθείτε ότι ο κεντρικός διακόπτης βρίσκεται στη θέση "I" και ότι το καλώδιο είναι σωστά συνδεδεμένο στην πρίζα.

GR

### Η μονάδα παρασκευής δεν μπορεί να αφαιρεθεί για καθαρισμό

- Η καφετιέρα είναι ενεργοποιημένη. Η μονάδα παρασκευής μπορεί να αφαιρεθεί μόνον όταν η καφετιέρα είναι απενεργοποιημένη.
- ☞ Απενεργοποιήστε τη συσκευή και αφαιρέστε τη μονάδα παρασκευής (βλέπε „Καθαρισμός της μονάδας παρασκευής“ Σελίδα 314).
- i** **Προσοχή: Η μονάδα παρασκευής μπορεί να αφαιρεθεί μόνο όταν η συσκευή έχει απενεργοποιηθεί με το πλήκτρο On/Off ① στην μπροστινή πλευρά της συσκευής. Η συσκευή δεν πρέπει να αποσυνδεθεί από το ρεύμα. Αν επιχειρήσετε να αφαιρέσετε τη μονάδα παρασκευής με ενεργοποιημένη την καφετιέρα, η καφετιέρα μπορεί να υποστεί σοβαρές ζημιές.**
- Ο καφές δεν βγαίνει από τις θέσεις εκροής καφέ, αλλά από τα πλάγια, από το πορτάκι σέρβις**
- Τα ανοίγματα της εκροής καφέ έχουν φράξει από ξεραμένο καφέ.
- ☞ Αφαιρέστε τα ξεραμένα υπολείμματα καφέ με μια βελόνα (εικόνα 29).
- Η στρεφόμενη θήκη (R) που βρίσκεται στο εσωτερικό του καπακιού σέρβις είναι μπλοκαρισμένη και δεν μπορεί να στραφεί.
- ☞ Καθαρίστε προσεκτικά τη στρεφόμενη θήκη, ιδιαίτερα κοντά στους μεντεσέδες, έτσι ώστε να διατηρηθεί η δυνατότητα κίνησής τους.
- Χρησιμοποιήθηκε σκόνη καφέ (αντί για κόκκους) και η καφετιέρα δεν παράγει καφέ.**
- Έχει εισαχθεί υπερβολική ποσότητα αλεσμένου καφέ.
- ☞ Αφαιρέστε τη μονάδα παρασκευής και καθαρίστε σχολαστικά το

εσωτερικό της καφετιέρας, όπως περιγράφεται στην ενότητα „Καθαρισμός της μονάδας παρασκευής“ Σελίδα 314. Επαναλάβετε τη διαδικασία χρησιμοποιώντας το πολύ 2 κοφτές μεζούρες καφέ σε σκόνη.

- Το περιστροφικό κουμπί "Γεύση καφέ / αλεσμένος καφές" δεν έχει γυριστεί στη θέση ☞ ή ☞ και η συσκευή έχει χρησιμοποιήσει προαλεσμένο καφέ μαζί με καφέ αλεσμένο από το μύλο.
- ☞ Καθαρίστε το εσωτερικό της καφετιέρας σχολαστικά, όπως περιγράφεται στην ενότητα „Καθαρισμός της μονάδας παρασκευής“ Σελίδα 314. Επαναλάβετε τη διαδικασία, γυρίζοντας πρώτα το περιστροφικό κουμπί "Γεύση καφέ / αλεσμένος καφές" στη σωστή θέση, όπως περιγράφεται στην ενότητα „Ετοιμασία καφέ με σκόνη“ Σελίδα 308.
- Ο αλεσμένος καφές έχει εισαχθεί με απενεργοποιημένη την καφετιέρα.
- ☞ Αφαιρέστε τη μονάδα παρασκευής και καθαρίστε σχολαστικά το εσωτερικό της καφετιέρας, όπως περιγράφεται στην ενότητα „Καθαρισμός της μονάδας παρασκευής“ Σελίδα 314. Επαναλάβετε τη διαδικασία με ενεργοποιημένη την καφετιέρα.

### Τι πρέπει να γίνει όταν η συσκευή χρειάζεται να μεταφερθεί;

- Φυλάξτε το κουτί της συσκευής για προστασία κατά τη μεταφορά. Για προστασία από τις γρατζουνιές, χρησιμοποιήστε οπωσδήποτε την πλαστική σακούλα της αρχικής συσκευασίας.
- Ασφαλίστε τη συσκευή και την κανάτα διατήρησης θερμότητας από κτυπήματα. Η εταιρεία δεν αναλαμβάνει καμία ευθύνη για την



πρόκληση ζημιών κατά τη μεταφορά.



- Αδειάστε το δοχείο νερού και το δοχείο συλλογής υπολειμμάτων καφέ.
- Παρακαλούμε προσέξτε και το σημείο τοποθέτησης της συσκευής, ιδίως το χειμώνα. Μπορεί να προκληθούν βλάβες εξαιτίας της παγωνιάς.

## 17 Τρόπος λειτουργίας στατιστικής



Η συσκευή αυτή σας παρέχει τη δυνατότητα να ενημερώνεστε για τις εξής τιμές:

- τον αριθμό καφέδων που έχουν παρασκευαστεί μέχρι στιγμής με τη συσκευή,
- τον αριθμό κανατών που έχουν παρασκευαστεί με περιεχόμενο 4, 6, 8 και 10 φλιτζάνια αντίστοιχα,
- τον αριθμό των αφαλατώσεων που έχουν πραγματοποιηθεί, και επιπλέον
- τον αριθμό των λίτρων νερού που έχουν εκρεύσει από τη μηχανή.

 Αν γεμίζετε ταυτόχρονα 2 φλιτζάνια καφέ, τότε αυτά καταμετρούνται πράγματι ως 2 φλιτζάνια. Για να ενεργοποιήσετε τον τρόπο λειτουργίας στατιστικής, η συσκευή πρέπει να είναι απενεργοποιημένη.

 Αν χρειάζεται, απενεργοποιήστε τη συσκευή με το πλήκτρο "On/Off"  (εικόνα 11).

 Κρατήστε το πλήκτρο "P" (εικόνα 4) πατημένο για τουλάχιστον 6 δευτερόλεπτα.

Ανάβουν τα σύμβολα "P" και . Επιπλέον ανάβουν τα 3 μικρά σύμβολα πάνω από τα πλήκτρα  και , για να δηλώσουν τη λειτουργία των συγκεκριμένων πλήκτρων τη δεδομένη στιγμή,

βλέπε „Ειδικός τρόπος λειτουργίας" Σελίδα 301.

 Πατήστε επανειλημμένα τα πλήκτρα περιήγησης "<" ή ">" (εικόνα 5) μέχρι να ανάψει το σύμβολο, για το οποίο θέλετε να προβάλετε την αντίστοιχη στατιστική:

 Αριθμός καφέδων που έχουν παρασκευαστεί

 Αριθμός αφαλατώσεων που έχουν πραγματοποιηθεί

 Αριθμός κανατών που έχουν παρασκευαστεί με περιεχόμενο 4 φλιτζάνια

 Αριθμός κανατών που έχουν παρασκευαστεί με περιεχόμενο 6 φλιτζάνια

 Αριθμός κανατών που έχουν παρασκευαστεί με περιεχόμενο 8 φλιτζάνια

 Αριθμός κανατών που έχουν παρασκευαστεί με περιεχόμενο 10 φλιτζάνια

 Αριθμός λίτρων νερού που έχουν εκρεύσει από τη μηχανή

Όταν κάποιο σύμβολο ανάβει, μπορείτε να εμφανίσετε τον αντίστοιχο αριθμό ως εξής:

 Πατήστε το πλήκτρο "OK" και κρατήστε το πατημένο (εικόνα 5). Τώρα αρχίζουν να αναβοσβήνουν μεμονωμένες ενδείξεις η μία μετά την άλλη, δηλώνοντας τον αριθμό που σας ενδιαφέρει:

 1 αναλαμπή αντιστοιχεί στον αριθμό 1

 1 αναλαμπή αντιστοιχεί στον αριθμό 10

 1 αναλαμπή αντιστοιχεί στον αριθμό 100





 1 αναλαμπή αντιστοιχεί στον αριθμό 1,000

 1 αναλαμπή αντιστοιχεί στον αριθμό 10,000

GR

Οι αναλαμπές επαναλαμβάνονται συνεχώς για όσο διάστημα παραμένει πατημένο το πλήκτρο "OK". Μεταξύ δυο επαναλήψεων υπάρχει μια παύση τριών δευτερολέπτων.

-  Μετρήστε τον αριθμό των μεμονωμένων αναλαμπών. Παράδειγμα: Η παρακάτω ακολουθία αναλαμπών αντιστοιχεί στον αριθμό 1.529.

 9 αναλαμπές  
 2 αναλαμπές  
 5 αναλαμπές  
 1 αναλαμπές  
 0 αναλαμπές

-  Για να εγκαταλείψετε τον τρόπο λειτουργίας στατιστικής, κρατήστε πατημένο το πλήκτρο "P" (εικόνα 4) για τουλάχιστον 6 δευτερόλεπτα.

## 18 Τεχνικά χαρακτηριστικά

Τάση δικτύου: 220-240 V  
 Κατανάλωση ισχύος: 1350 W

-  Η παρούσα συσκευή συμμορφώνεται προς τις ακόλουθες οδηγίες της ΕΚ:
- 73/23/ΕΟΚ της 19.2.1973 "Οδηγία περί Χαμηλής Τάσης", συμπεριλαμβανομένης της τροποποιητικής οδηγίας 93/68/ΕΟΚ.
  - 89/336/ΕΟΚ της 3.5.1989 "Οδηγία περί Ηλεκτρομαγνητικής Συμβατότητας", συμπεριλαμβανομένης της τροποποιητικής οδηγίας 92/31/ΕΟΚ.

## 19 Απόρριψη



### Υλικά συσκευασίας

Τα υλικά συσκευασίας είναι φιλικά προς το περιβάλλον και ανακυκλώσιμα. Τα πλαστικά μέρη φέρουν τη σχετική σήμανση, π.χ. >PE<, >PS< κλπ. Απορρίψτε τα υλικά συσκευασίας σύμφωνα με τη σήμανσή τους στα προβλεπόμενα για το σκοπό αυτό δοχεία που βρίσκονται στα σημεία απόρριψης των δήμων και κοινοτήτων.



### Αχρηστευμένη συσκευή

Το σύμβολο  στη συσκευή ή τη συσκευασία της επισημαίνει ότι το προϊόν αυτό δεν πρέπει να απορρίπτεται στα οικιακά απορρίμματα, αλλά να παραδίδεται σε ένα σημείο συλλογής ηλεκτρικών και ηλεκτρονικών συσκευών που προορίζονται για ανακύκλωση. Με τη συμβολή σας στην ορθή απόρριψη αυτής της συσκευής προστατεύετε το περιβάλλον και την υγεία των συνανθρώπων σας. Η απόρριψη με εσφαλμένο τρόπο θέτει σε κίνδυνο το περιβάλλον και την υγεία. Περισσότερες πληροφορίες σχετικά με την ανακύκλωση αυτού του προϊόντος μπορείτε να πάρετε από τις δημοτικές αρχές ή τις υπηρεσίες αποκομιδής απορριμμάτων της περιοχής σας, ή από το κατάστημα, από το οποίο αγοράσατε το προϊόν.

## 20 Σε περίπτωση που χρειαστεί σέρβις

Φυλάξτε οπωσδήποτε την αρχική συσκευασία και τα παρενθέματα από αφρώδες υλικό. Για να αποφύγετε ζημιές κατά τη μεταφορά, η συσκευή πρέπει να είναι καλά συσκευασμένη.

Κατά την αποστολή της συσκευής για επισκευή φροντίστε πάντα να συνοδεύεται από την κανάτα διατήρησης θερμότητας. Είναι απαραίτητη για τον έλεγχο της συσκευής.

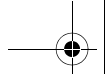

GR

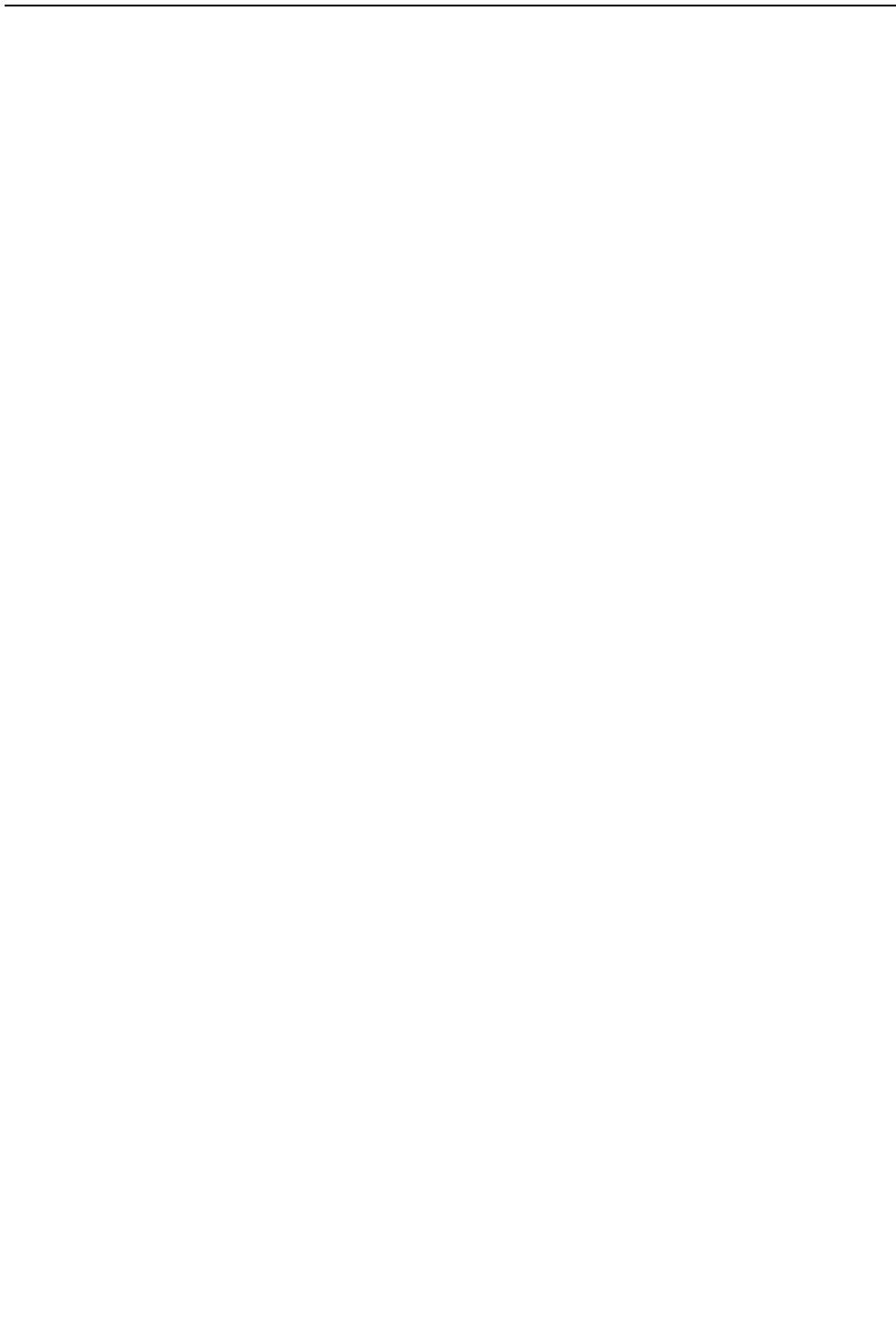

323

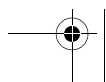
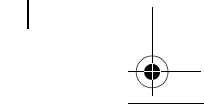
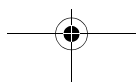
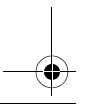
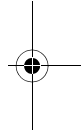
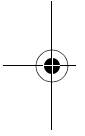

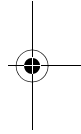
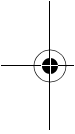
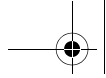

Electrolux Hausgeräte Vertriebs GmbH  
Muggenhofer Str. 135  
D-90429 Nürnberg

<http://www.electrolux.de>

© Copyright by Electrolux

822 949 351 - 01 - 0307

