

# Tefal®

 PDF LOW DEFINITION

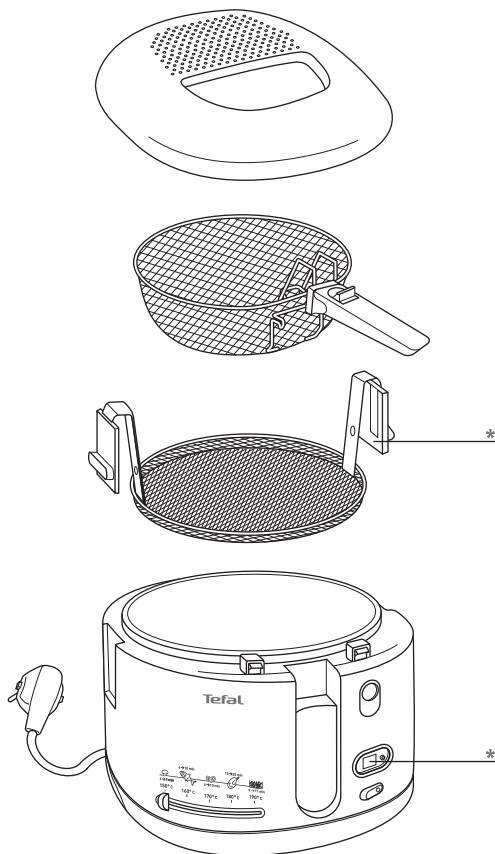

[www.tefal.com](http://www.tefal.com)



\* Selon modèle • Afhankelijk van het model • Je nach Modell • Depending on model • Secondo i modelli • Según modelo • Consoante o modelo • ανάλογα με το μοντέλο • Modele göre • Áfhængig af model • Beroende på modell • Avhenger av modell • Mallista riippuen • Ovisno o modelu • Žavisno od modela • в зависимости от модели • Odvisno od modela • W zależności od typu • Podle modelu • V závislosti od modelu • Modelltól függően • В зависимости от модели • Залежно від моделі • Ovisno o modelu • Sõltuvalt mudelist • Atbilstoši modelim • Pagal modelį • بر حسب الموديل • بحسب مدل \*

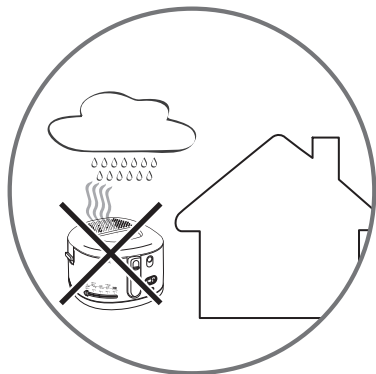

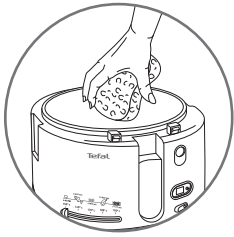
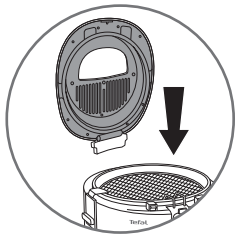
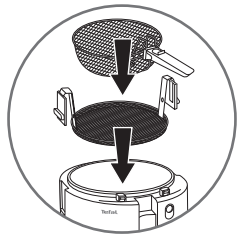
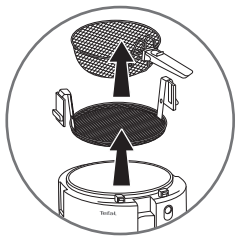
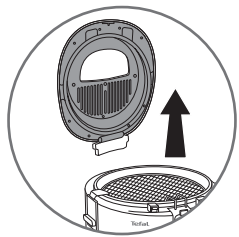
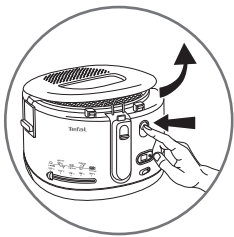



Min. 1,9 l  
Max. 2,1 l

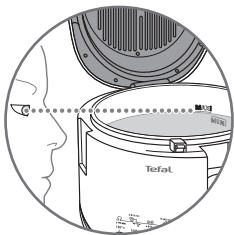
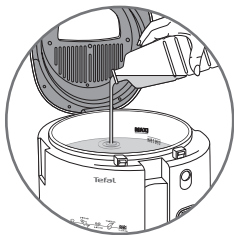

Min. 1660 g  
Max. 1910 g

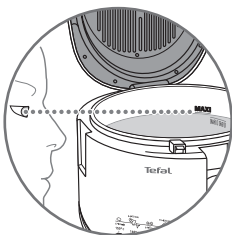
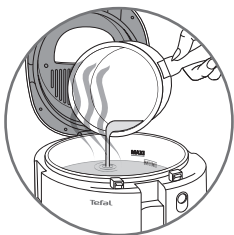
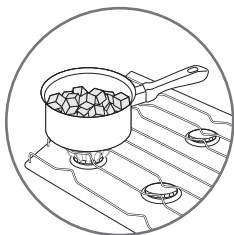



Max. 1200 g

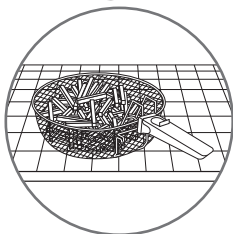
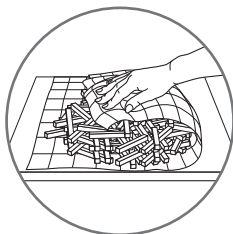

Max. 900 g

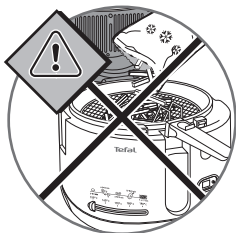
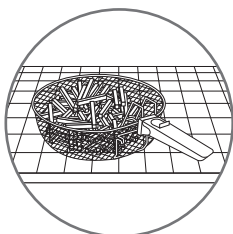
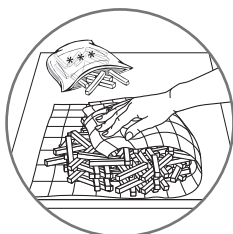

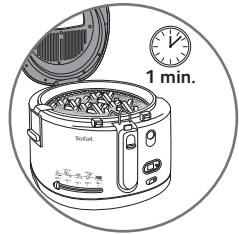
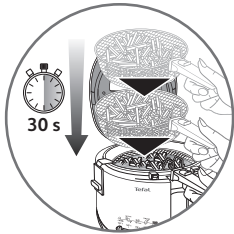
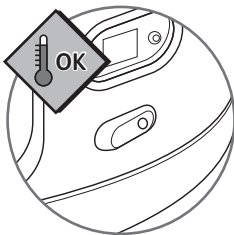
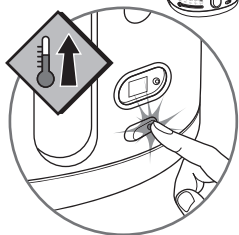
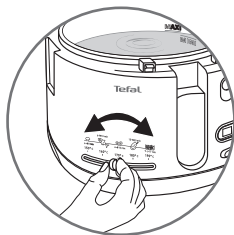
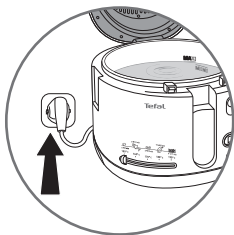

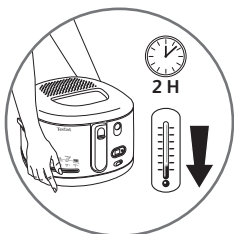
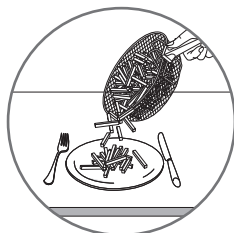
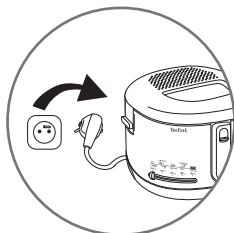
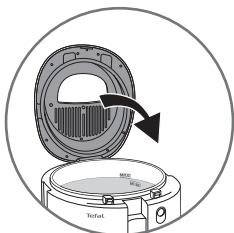
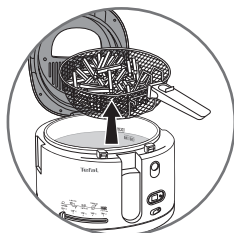
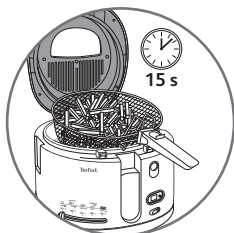
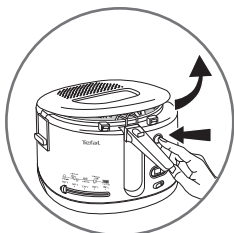
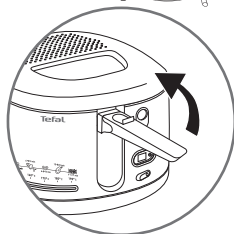
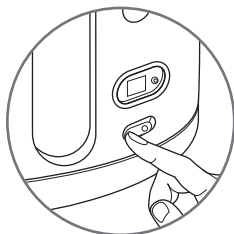
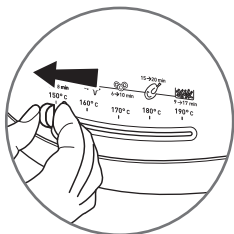



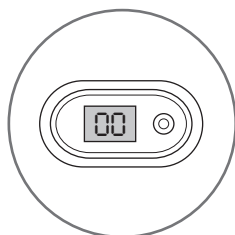
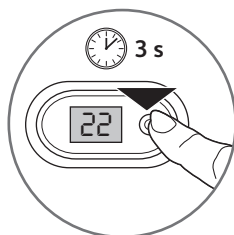
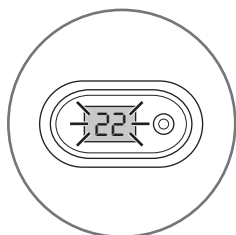
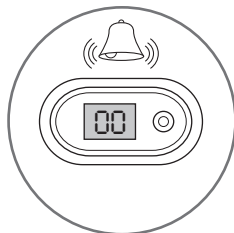
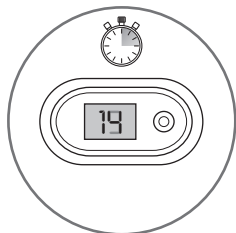
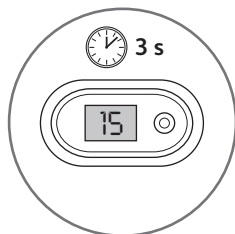
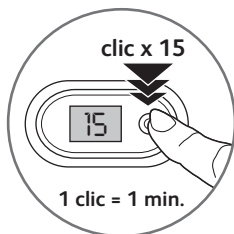
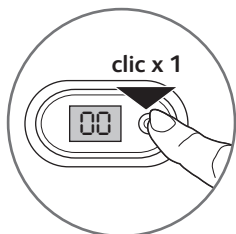



























\* Selon modèle • Afhankelijk van het model • Je nach Modell • Depending on model • Secondo i modelli • Según modelo • Consoante o modelo • ανάλογα με το μοντέλο • Modelle göre • Áfhængig af model • Beroende på modell • Avhenger av modell • Mallista riippuen • Ovisno o modelu • Zavisno od modela • в зависимости от модели • Odvisno od modela • W zależności od typu • Podle modelu • V závislosti od modelu • Modelltól függően • В зависимости от модели • Залежно від моделі • Ovisno o modelu • Sõltuvalt mudelist • Atbilstoši modelim • Pagal modelį • بر حسب الموديل • بر حسب مدل



	Nb			
		600 g	170°C	+/- 11-13 min
		1000 g	190°C	+/- 14-16 min
		1200 g	1 170°C 2 190°C	+/- 6-8 min +/- 10-12 min
		350/400 g	190°C	+/- 6-7 min
	8		180°C	+/- 13-15 min
	3		170°C	+/- 6-8 min
		200 g	150°C	+/- 8-10 min
	7-8		180°C	+/- 8-10 min
	6		180°C	+/- 6-8 min
<b>* * *</b>	Nb			
		750 g	190°C	+/- 8-10 min
		450 g	170°C	+/- 8-10 min
	10		190°C	+/- 6-8 min
	8		190°C	+/- 13-15 min
		900 g	190°C	+/- 7-8 min
		300 g	190°C	+/- 5-6 min

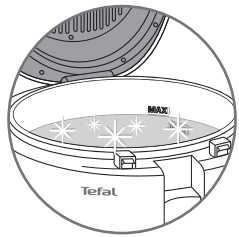
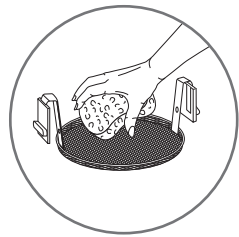
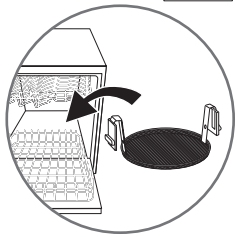
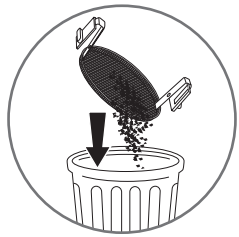

\* Selon modèle • Afhankelijk van het model • Je nach Modell • Depending on model • Secondo i modelli • Según modelo • Consoante o modelo • ανάλογα με το μοντέλο • Modele göre • Áfhængig af model • Beroende på modell • Avhenger av modell • Mallista riippuen • Ovisno o modelu • Zavisno od modela • в зависимости от модели • Odvisno od modela • W zależności od typu • Podle modelu • V závislosti od modelu • Modelltól függően • В зависимости от модели • Залежно від моделі • Ovisno o modelu • Sõltuvalt mudelist • Atbilstoši modelim • Pagal modelį • بر حسب المدل • حسب الموديل

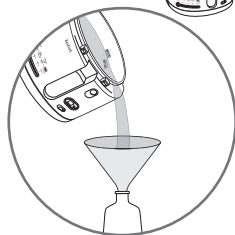
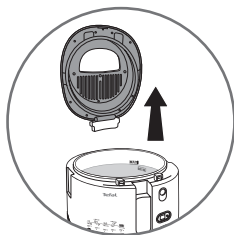

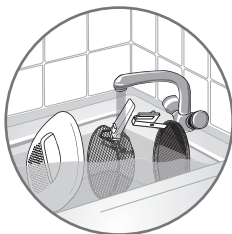
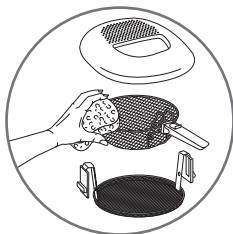
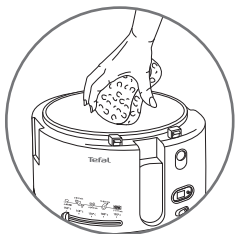
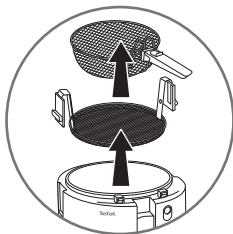
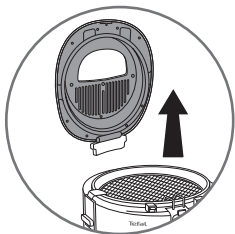



 : [www.tefal.com](http://www.tefal.com)

			
<b>ALGERIA</b>	GROUPE SEB EXPORT Chemin du Petit Bois, Les 4M 69130 ECULLY - FRANCE	<b>213-41 28 18 53</b>	1 year
<b>ARGENTINA</b>	GROUPE SEB ARGENTINA S.A. Billinghurst 1833 3º C1425DTK Capital Federal Buenos Aires	<b>0800-122-2732</b>	2 años
<b>ՀԱՅԱՍՏԱՆ ARMENIA</b>	«Գրուպպա ՍԵԲ-Վոստոկ»ՓԲԸ, 119180 Մոսկվա, Ռուսաստան Ստարոմոնետնի կրք., ս.14, շ.2	<b>(010) 55-76-07</b>	2 տարի/ years
<b>AUSTRALIA</b>	GROUPE SEB AUSTRALIA PO Box 7535, Silverwater NSW 2128	<b>02 97487944</b>	1 year
<b>ÖSTERREICH</b>	SEB ÖSTERREICH HmbH Campus 21 - Businesspark Wien Süd Liebermannstr. A02 702 2345 Brunn am Gebirge	<b>01 866 70 299 00</b>	2 Jahre
<b>BELGIQUE / BELGIE</b>	GROUPE SEB BELGIUM SA NV 25 avenue de l'Espérance - ZI 6220 Fleurus	<b>32 70 23 31 59</b>	2 ans / years
<b>БЕЛАРУСЬ / BELARUS</b>	ЗАО «Группа СЕБ-Восток», 119180 Москва, Россия Старомонетный пер. д.14 стр.2	<b>017 2239290</b>	2 года/ years
<b>BOSNA I HERCEGOVINA</b>	SEB Développement Predstavništvo u BiH Vrazova 8/II 71000 Sarajevo	<b>Info-linija za potrošače 033 551 220</b>	2 godine
<b>BRASIL</b>	GRUPO SEB DO BRASIL PRODUTOS DOMESTICOS LTDA Avenida Arno, 146 Mooca 03108-900 São Paulo SP	<b>0800-119933</b>	1 ano
<b>БЪЛГАРИЯ/ BULGARIA</b>	ГРУП СЕБ БЪЛГАРИЯ ЕООД Ул. Борово 52 Г, ет. 1, офис 1, 1680 София	<b>0700 10 330</b>	2 ГОДИНИ
<b>CANADA</b>	GROUPE SEB CANADA 345 Passmore Avenue Toronto, ON M1V 3N8	<b>1-800-418-3325</b>	1 year
<b>CHILE</b>	GROUPE SEB CHILE Comercial Ltda Avda. Nueva Los Leones 0252 Providencia, Santiago	<b>+56 2 232 77 22</b>	2 años
<b>COLOMBIA</b>	GROUPE SEB COLOMBIA Apartado Aereo 172, Kilometro 1 Via Zipaquira Cajica Cundinamarca	<b>18000919288</b>	2 años
<b>HRVATSKA Croatia</b>	SEB Développement S.A.S. Vodnjanska 26 10000 Zagreb	<b>01 30 15 294</b>	2 godine
<b>ČESKÁ REPUBLIK / CZECH REPUBLIC</b>	GROUPE SEB ČR spol. s r. o. Jankovcova 1569/2c 170 00 Praha 7	<b>731 010 111</b>	2 roky
<b>DANMARK</b>	GROUPE SEB NORDIC AS Tempovej 27 2750 Ballerup	<b>44 663 155</b>	2 år
<b>DEUTSCHLAND</b>	GROUPE SEB DEUTSCHLAND GmbH / KRUPS GmbH Herrrainweg 5 63067 Offenbach	<b>0212 387 400</b>	2 Jahre

 : [www.tefal.com](http://www.tefal.com)

			
<b>EESTI/ ESTONIA</b>	GRUPE SEB POLSKA SP Z O.O. ul. Ostrobramska 79 04-175 Warszawa	<b>5 800 3777</b>	2 aastat
<b>SUOMI / FINLAND</b>	Groupe SEB Finland Kutojantie 7 02630 Espoo	<b>09 622 94 20</b>	2 Vuotta
<b>FRANCE</b> Inclus Martinique, Guadeloupe, Réunion & St. Martin	GRUPE SEB France SAS Place Ambroise Courtois 69355 Lyon Cedex 08	<b>09 74 50 47 74</b>	1 an
<b>GREECE / ΕΛΛΑΔΑ</b>	SEB GROUPE ΕΛΛΑΔΟΣ Α.Ε. Οδός Φραγκοκκλησιάς 7 Τ.Κ. 151 25 Παράδεισος Αμαρουσίου	<b>2106371251</b>	2 χρόνια
<b>HONG KONG</b>	SEB ASIA Ltd. Room 901, 9/F, North Block, Skyway House 3 Sham Mong Road, Tai Kok Tsui, Kowloon	<b>852 8130 8998</b>	1 year
<b>MAGYARORSZÁG/ Hungary</b>	GRUPE SEB CENTRAL-EUROPE Kft. Tavíro köz 4 2040 Budaörs	<b>(1) 8018434</b>	2 év
<b>INDONESIA</b>	Groupe SEB Indonesia (Representative office) Sudirman Plaza, Plaza Marein 8th Floor JL Jendral Sudirman Kav 76-78, Jakarta 12910, Indonesia	<b>+62 21 5793 6881</b>	1 year
<b>ITALIA</b>	GRUPE SEB ITALIA S.p.A. Via Montefeltro, 4 20156 Milano	<b>199207354</b>	2 anni
<b>JAPAN</b>	GRUPE SEB JAPAN Co. Ltd. 1F Takanawa Muse Building, 3-14-13, Higashi Gotanda, Shinagawa-Ku, Tokyo 141-0022	<b>0570-077772</b>	1 year
<b>ҚАЗАҚСТАН KAZAKHSTAN</b>	«Группа СЕБ-Восток» ЖАҚ, 119180 Мәскеу, Ресей Старомонетный тұйық көш, 14-үй, 2-құрылыс	<b>727 378 39 39</b>	2 жыл / years
<b>KOREA</b>	(유)그림 세브 코리아 서울시 종로구 서린동 88 서린빌딩 3층 110-790	<b>1588-1588</b>	1 year
<b>LATVJA / LATVIA</b>	GRUPE SEB POLSKA SP Z O.O. ul. Ostrobramska 79 04-175 Warszawa	<b>6 716 2007</b>	2 gadi
<b>LIETUVA/ LITHUANIA</b>	GRUPE SEB POLSKA SP Z O.O. ul. Ostrobramska 79 04-175 Warszawa	<b>6 470 8888</b>	2 metai
<b>MACEDONIA</b>	Groupe SEB Bulgaria EOOD Office 1, floor 1, 52G Borovo St., 1680 Sofia - Bulgaria ГРУП СЕБ БЪЛГАРИЯ ДООЕЛ Ул. Борово 52 Г, сп. 1, офис 1, 1680 София, България	<b>(0)2 20 50 022</b>	2 години / years
<b>MALAYSIA</b>	GRUPE SEB MALAYSIA SDN. BHD Lot No.C/3A/001 & 002, Block C, Kelana Sq. No.17, Jalan SS7/26, 47301 Kelana Jaya Petaling Jaya, Selangor	<b>65 6550 8900</b>	1 year
<b>MEXICO</b>	G.S.E.B. MEXICANA, S.A. de C.V. Goldsmith 38 Desp. 401, Col. Polanco Delegacion Miguel Hidalgo 11 560 Mexico D.F.	<b>(01800) 112 8325</b>	1 años



			
<b>MOLDOVA</b>	ТОВ «Грун СЕБ Україна» Вул. Драгоманова 31 Б, офіс 1 02068 Київ, Україна	<b>(22) 929249</b>	2 ani / years
<b>NEDERLAND</b>	GROUPE SEB NEDERLAND BV Generatorstraat 6 3903 LJ Veenendaal	<b>0318 58 24 24</b>	2 jaar
<b>NEW ZEALAND</b>	GROUPE SEB NEW ZEALAND Unit E, Building 3, 195 Main Highway, Ellerslie, Auckland	<b>0800 700 711</b>	1 year
<b>NORGE</b>	GROUPE SEB NORDIC AS Tempovej 27 2750 Ballerup DANMARK	<b>815 09 567</b>	2 år
<b>PERU</b>	GROUPE SEB COLOMBIA Av. Camino Real N° 111 of. 805 B San Isidro - Lima - Perú	<b>+511 441 4455</b>	1 años
<b>POLSKA/ POLAND</b>	GROUPE SEB POLSKA SP Z O.O. ul. Ostrobramska 79 04-175 Warszawa	<b>0801 300 422</b> koszt jak za połączenie lokalne	2 lata
<b>PORTUGAL</b>	GROUPE SEB IBÉRICA SA Urb. da Matinha Rua Projectada à Rua 3 Bloco1 - 3° B/D 1900 - 796 Lisboa	<b>808 284 735</b>	2 anos
<b>REPUBLIC OF IRELAND</b>	GROUPE SEB IRELAND Unit B3 Aerodrome Business Park, College Road, Rathcoole, Co. Dublin	<b>01 677 4003</b>	1 year
<b>ROMÂNIA/ ROMANIA</b>	GROUPE SEB ROMÂNIA Str. Daniel Constantin nr. 8 010632 Bucuresti	<b>0 21 316 87 84</b>	2 ani
<b>РОССИЯ/ RUSSIA</b>	ЗАО «Группа СЕБ-Восток», 119180 Москва, Россия Старомонетный пер. д.14 стр.2	<b>495 213 32 37</b>	2 года/ years
<b>SRBIJA Serbia</b>	SEB Developpement Antifasistické borbe 17/13 11070 Novi Beograd	<b>060 0 732 000</b>	2 godine
<b>SINGAPORE</b>	GROUPE SEB SINGAPORE Pty Ltd. 59 Jalan Pemimpin, #04-01/02 L&Y Building Singapore 577218	<b>65 6550 8900</b>	1 year
<b>SLOVENSKO/ SLOVAKIA</b>	GROUPE SEB SLOVENSKO s.r.o. Rybničná 40 831 07 Bratislava	<b>233 595 224</b>	2 roky
<b>SLOVENIJA</b>	SEB d.o.o Gregorčičeva ulica 6 2000 MARIBOR	<b>02 234 94 90</b>	2 leti
<b>ESPAÑA</b>	GROUPE SEB IBÉRICA S.A. Almogüvers, 119-123. Complejo Ecurban 08018 Barcelona	<b>0902 31 25 00</b>	2 años
<b>SVERIGE</b>	TEFAL SVERIGE SUBSIDIARY OF GROUP SEB NORDIC Truckvägen 14 A, 194 52 Upplands Väsby	<b>08 594 213 30</b>	2 år
<b>SUISSE SCHWEIZ</b>	GROUPE SEB SCHWEIZ GmbH Thurgauerstrasse 105 8152 Glattbrugg	<b>044 837 18 40</b>	2 ans / Jahre
<b>TAIWAN</b>	SEB ASIA Ltd. Taipei International Building, Suite B2, 6F-1, No. 216, Tun Hwa South Road, Sec. 2 Da-an District Taipei 106, R.O.C.	<b>886-2-27333716</b>	1 year

 : [www.tefal.com](http://www.tefal.com)

			
<b>THAILAND</b>	GROUPE SEB THAILAND 2034/66 Italthai Tower, 14th Floor, n° 14-02, New Phetchburi Road, Bangkapi, Huaykwang, Bangkok, 10320	<b>02723 4488</b>	2 years
<b>TÜRKIYE</b>	GROUPE SEB ISTANBUL AS Beybi Giz Plaza Dereboyu Cad. Meydan Sok. No: 28 K.12 Maslak	<b>216 444 40 50</b>	2 YIL
<b>U.S.A.</b>	GROUPE SEB USA 2121 Eden Road Millville, NJ 08332	<b>800-769-3682</b>	1 year
<b>Україна/ UKRAINE</b>	ТОВ «Грул СЕБ Україна» Вул. Драгоманова 31 Б, офіс 1 02068 Київ, Україна	<b>044 492 06 59</b>	2 роки/ years
<b>UNITED KINGDOM</b>	GROUPE SEB UK Ltd. 11-49 Station Road Langley, Slough Berkshire SL3 8 DR	<b>0845 602 1454</b>	1 year
<b>VENEZUELA</b>	GROUPE SEB VENEZUELA Av Eugenio Mendoza, Centro Letonia, Torre ING Bank, Piso 15, Ofc 155 Urb. La Castellana, Caracas	<b>0800-7268724</b>	2 anno
<b>VIETNAM</b>	GROUPE SEB VIETNAM (Representative office) 127-129 Nguyen Hue Street District 1, Ho Chi Minh City, Vietnam	<b>+84-8 3821 6395</b>	1 year

# TEFAL / T-FAL INTERNATIONAL GUARANTEE

**Date of purchase:** ..... / Date d'achat / Fecha de compra /  
Data da compra / Data d'acquisto / Kaufdatum / Aankoopdatum / Købsdato / Inkøpsdatum /  
Kjøpsdato / Ostopäivä / Data zakupu / Data vânzării / Isigijimo data/ Ostukuupäev / Datum nakupa /  
Sorozatsszám / Dátum nákupu / Pirkuma datums / Datum Kupovine / Datum kupnje / Data  
cumpărării / Datum nákupu / Tarikh pembelian / Tanggal pembelian / Ngày mua hàng/ Satim alma  
tarihli / Дата продажи / Дата продаж / Дата на закупуване / Датум на купување / Сатылган  
мерзімі / Ημερομηνία αγοράς/ Ψαδωνρηη ορη /วันที่ซื้อ / 購買日期/ 購入日/ 구입일자/ تاريخ  
خرید/ تاريخ الشراء

**Product reference:** ..... / Référéncie du produit / Referencia del  
producto / Nome do produto / tipo de prodotto / Typnummer des Gerätes / Artikelnummer van het  
apparaat / Referencenummer / Produktreferens / Artikelnummer / Tuotenumero / referenca  
produktu / Model / Gaminio numeris / Toote viitenumber / Tip aparata / Vásárlás kelte / Тип  
výrobku / Produkta atsauces numurs / Model proizvoda / Oznaka proizvoda / Cod produs / Produk  
rujukan / Referensi produk / Mã sản phẩm/ Ürün kodu / Модель / Модель / Модел на уреда /  
Модели / Кодικός προϊόντος / Уηηηη / รุ่นผลิตภัณฑ์ / 產品模型 / 製品レファレンス番号 / 제품명/  
مرجع كامل محصول / مرجع المنتج الكامل

**Retailer name & address:** .....  
/ Nom et adresse du vendeur / Nombre y direcció del minorista / Nome e endereço do revendedor  
/ Nome e indirizzo delnegozzio / Name und Anschrift des Händlers / Naam en adres van de dealer /  
Forhandler navn & adresse / Återförsäljarens namn och adress / Forhandler navn og adresse /  
Jälleenmyyjän nimi ja osoite / nazwa i adres sprzedawcy / Numele și adresa vânzătorului /  
Parduotuvės pavadinimas ir adresas / Müüja kauplus ja aadress / Naziv in naslov trgovine /  
Típuszám / Názov a adresa predajcu / Veikala nosaukums un adrese / Naziv i adresa maloprodaje /  
Naziv i adresa prodavca / Naziv i adresa prodajnog mjesta / Nume și adresă vânzător / Název a  
adresa prodejece / Nama dan alamat peruncit / Nama Toko Penjual dan alamat / Tên và địa chỉ cửa  
hàng bán/ Satıcı firmanın adı ve adresi / Название и адрес продавца / Назва і адреса продавця /  
Търговски обект / Назив и адреса на продавницата / Сатушының аты және мекен-жайы /  
Επωνυμία και διεύθυνση καταστήματος / Ψαδωνρηηη ηηηηηηηη η ηηηηηηηη η ηηηηηηηη /  
ชื่อและที่อยู่ของห้าง/ร้านที่ซื้อ / 零售商的店名和地址/販売店の名前、住所/소매점 이름과 주소/  
نام وادرس خردہ فروش / اسم بائع التجزئة و عنوانه

**Distributor stamp** ..... /Cachet distributeur /Sello del distribuidor /

Carimbo do revendedor / Timbro del negozio / Händlerstempel / Stempel van de dealer /  
Forhandler stempel / Återförsäljarens stämpel / Forhandler stempel / Jälleenmyyjän leima / pieczęć  
sprzedawcy / Štampila vânzătorului / Antspaudas / Tempel / Žig trgovine / Eladó neve, címe/  
Razítko predajcu / Zīmogs / Pečat maloprodaje/ Pečat prodavca / Pečat prodajnog mjesta / Štampila  
vânzătorului/ Razítko prodejece/ Cap peruncit / Cap dari Toko Penjual / Cửa hàng bán đóng dấu/  
Satıcı Firmanın Kaşesi / Печать продавца / Печатка продавця / Печат на търговския обект /  
Печат на продавницата / Сатушының мөрі / Σφραγίδα καταστήματος / Ψαδωνρηηη ηηηηηηηη ηηηηηηηη  
ตราประทับของห้าง/ร้านที่ซื้อ / 零售商的蓋印 / 販売店印/소매점 직인/ ختم بائع التجزئة/ مهر خردہ

فروش

