

AKAI

Bluetooth Micro Hi-Fi System



AM-301W-N



AM-301K-N

Read this manual thoroughly before using and
save it for future reference

Contents

Safety Information and Warnings.....	2
Guide to the Appliance.....	4
Getting Started.....	7
Operation Instructions.....	9
Care and Maintenance.....	14
Troubleshooting.....	15
Technical Specifications.....	16

Safety Information and Warnings

DANGER - Indicates an imminently hazardous situation, which, if not avoided, will result in death or serious injury. This symbol appears only in the most extreme situations.

WARNING - Indicates a potentially hazardous situation which could result in death or serious injury.

CAUTION - Indicates a potentially hazardous situation, which, if not avoided, may result in minor/moderate injury or product/property/damage. It also warns against unsafe practices

TO PREVENT FIRE OR SHOCK HAZARD DO NOT EXPOSE THIS APPLIANCE TO RAIN OR MOISTURE.



LIGHTNING FLASH WITH ARROWHEAD SYMBOL -

Within an equilateral triangle, is intended to alert the user to the presence of uninsulated dangerous voltage within the products enclosure that may be of sufficient magnitude to constitute a risk of electric shock to persons.



EXCLAMATION POINT -

Within an equilateral triangle is used to indicate that a specific component shall be replaced only by the component specified in that documentation for safety reason.

The following label has been affixed to the unit, listing the proper procedure for working with the laser beam:

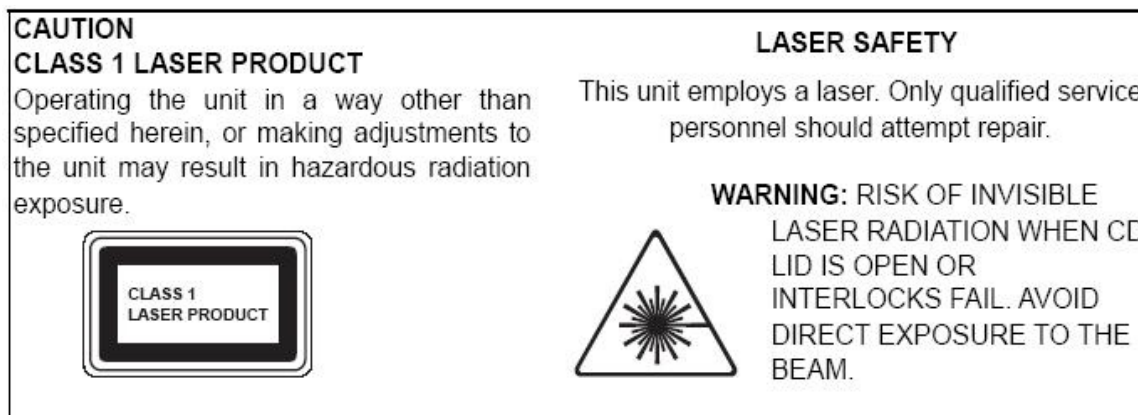

SAFETY INTRUCTIONS

- 1) Read this Instruction Manual before you attempt to connect or operate the appliance.
- 2) Keep these instructions in good condition. Heed all warnings. Follow all instructions.
- 3) Save this Instruction Manual for future reference.
- 4) The unit shall not be exposed to dripping or splashing and no objects filled with liquids, such as vases, shall be placed on the product. Dry location uses only.
- 5) No naked flame source, such as candles, should be placed near the product.
- 6) Children should be supervised to ensure that they do not play with the appliance.
- 7) Ventilation should not be impeded by covering the ventilation openings.
- 8) Make sure that the unit is plugged into an AC 220-240V 50Hz power outlet. Using higher voltage may cause the unit to malfunction. Turn off the unit before unplugging it from a power source to completely switch it off.
- 9) Do not plug/ unplug the power plug into/from an electrical outlet with wet hands.
- 10) If the power plug does not fit into your outlet, do not force.
- 11) Only use accessories which are specified by the manufacturer.
- 12) Use replacement parts which are specified by the manufacturer.
- 13) Install the unit in accordance with the manufacturer's instructions.
- 14) Place the unit where there is good ventilation. Place the system on a flat, hard and stable surface. Do not expose to temperatures above 40°C. Allow at least 10 cm clearance from the rear and the top of the unit and 5 cm from each side.
- 15) Press buttons gently. Pressing them too hard can damage the unit.
- 16) Always ensure that the product is unplugged from the electrical outlet before moving or cleaning. Clean it with dry cloth only.
- 17) Unplug the product during lightning, storms or when it will not be used for long periods of time.
- 18) This product has no user-serviceable parts. Do not attempt to repair this product yourself. Only qualified service personnel should perform servicing. Take the product to the electronics repair shop of your choice for inspection and repair.
- 19) NEVER let anyone, especially children, push anything into holes, slots or any other openings in the unit's casing as this could result in a fatal electric shock.
- 20) This unit is for indoor and dry location use only.
- 21) Do not leave the unit unattended when in use.
- 22) Dispose of used batteries in an environmental-responsible manner.

NOTE: when the system is switched to standby mode, it is still consuming power. To disconnect the system completely, remove the AC power plug from the wall outlet.

Guide to the Appliance

Front Panel

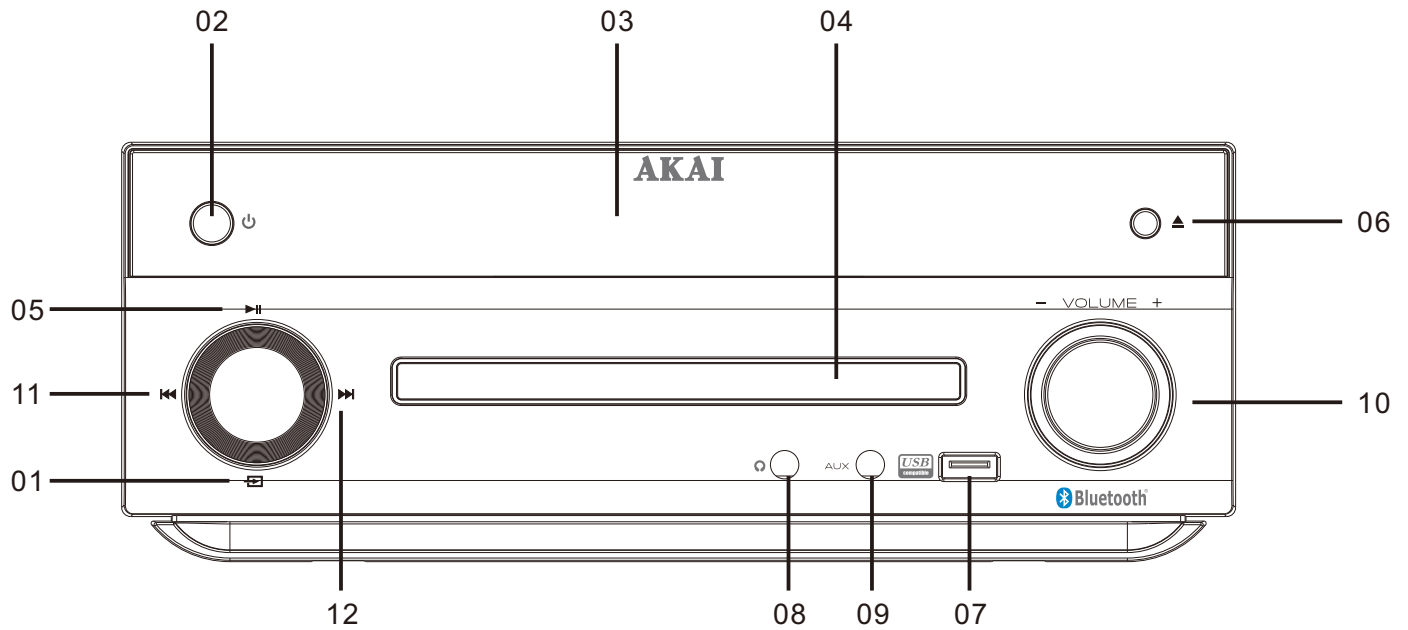

- | | |
|-----------------|--------------------|
| 1. Source | 7. USB Port |
| 2. Power On/OFF | 8. Headphone Jack |
| 3. Display | 9. Aux Jack |
| 4. CD Tray | 10. Volume Control |
| 5. Play/Pause | 11. Previous |
| 6. CD Eject | 12. Next |

Rear Panel

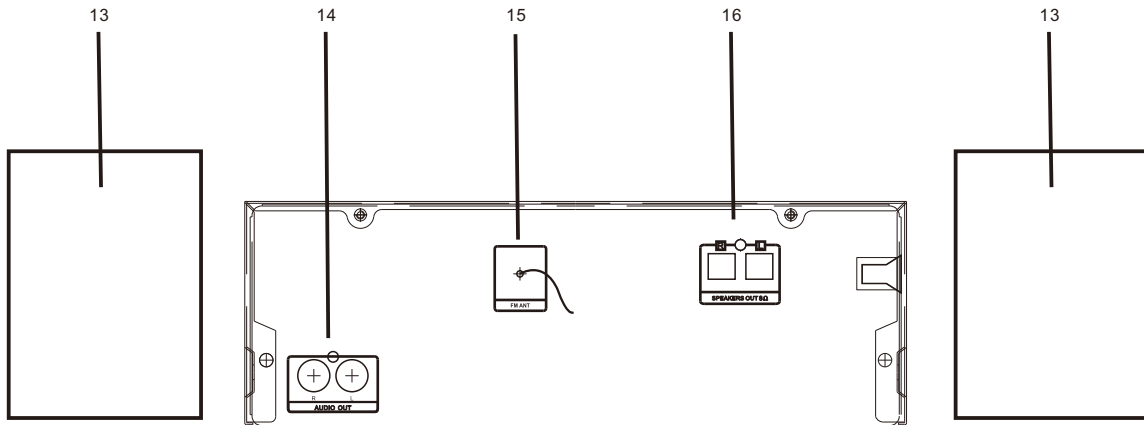

13. Satellite Speaker

14. Audio socket for Satellite Speaker

15. FM antenna

16. External Speaker Output Terminal

Remote Control

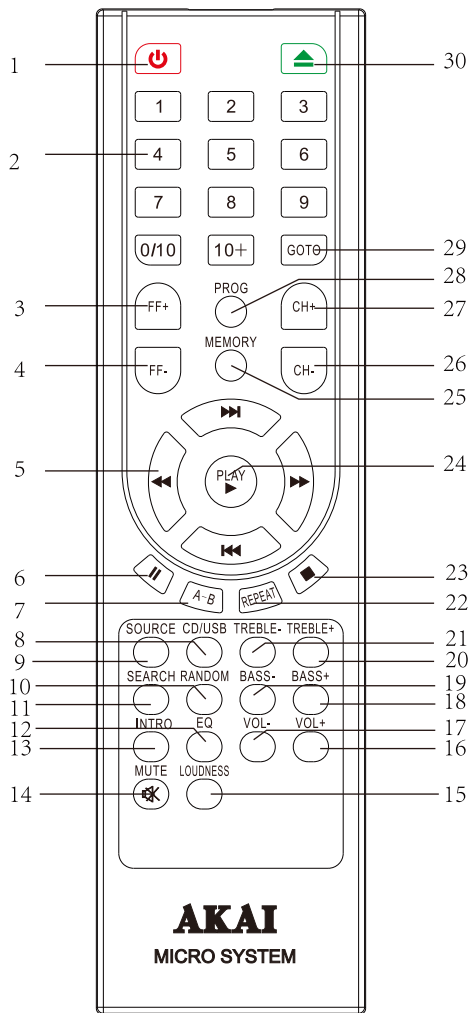

- 1.Standby
- 2.Digits button
- 3-4.FM frequency manual+/-
- 5.Previous/next/fast-forward/fast-rewind button
- 6.Pause
- 7.A-B
- 8.CD/USB mode
- 9.Source
- 10.Random
- 11.Search
- 12.EQ
- 13.Intro
- 14.Mute
- 15.Loudness
- 16-17. Volume+/-
- 18-21. Treble & bass adjustment
- 22.Repeat
- 23.Stop
- 24.Play
- 25.Memory
- 26-27. Channel+/-
- 28.Program
- 29.GOTO
- 30.Eject

IR REMOTE SENOR

- Even if the remote control is operated within the effective range, its operation may be impossible if there are obstacles between the appliance and the remote control.
- If the remote control is operated near other appliances which generate infrared rays, or if other remote control devices using infrared rays are used near the appliance, it may operate incorrectly.

REMOTE CONTROL BATTERY INSTALLATION

Insert 2 AAA TYPE batteries (not included) into the battery compartment. Ensure that the battery is inserted correctly to avoid damage to the remote control. Always remove batteries when the remote control will not be used for a long period of time, as this may cause leakage to the battery and subsequently damage your remote control.

BATTERY INSTALLATION

Slide out cover and install 2 AAA TYPE batteries (not included) with polarities as shown:

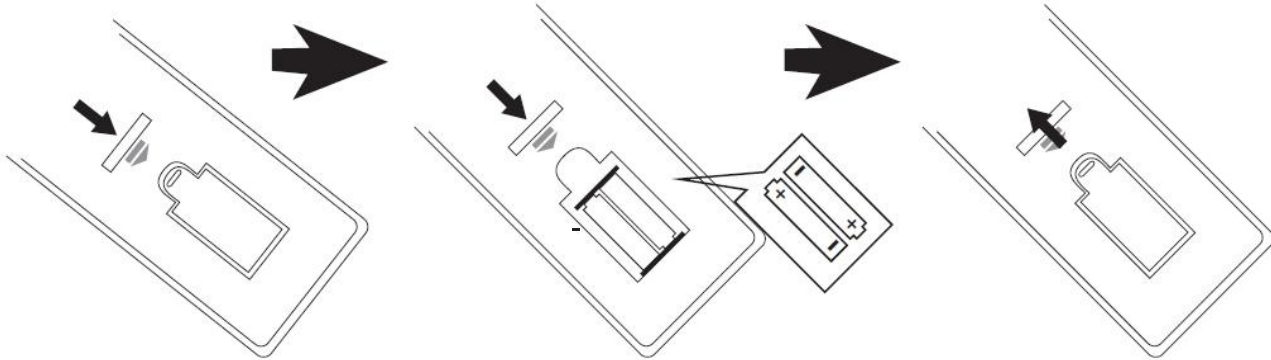

Notes:

- If the distance required between the remote control and the appliance decreases, the batteries are exhausted. In this case replace the batteries with new one.
- The main unit must be in standby mode in order for the remote control to operate.

Getting Started

PREPARATION FOR USE

Unpacking and setup:

Make sure nothing is accidentally discarded with the packing materials.



AM-301



Remote Control



Audio cable 3.5mm

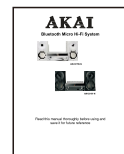

User manual

CONNECTIONS

1. Check if the power voltage, as shown on the type plate located on the back of the set, corresponds to your local AC supply power supply. If it does not, consult your dealer or service center.
2. Connect the speaker to the unit. Connect the speaker cables to the front speaker terminals. Connect the black end of each wire to the terminal marked - (minus) and the other end to the terminal marked + (plus).
3. Connect the power plug to the wall outlet. The power supply is now connected and ready for use.

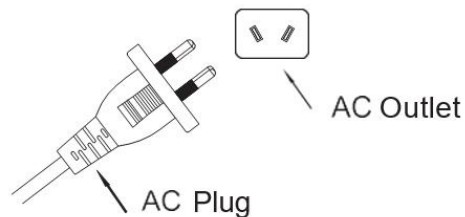

4. To switch off completely, turn off the main power by on/off button and unplug the power cord from the wall outlet.
 - ξ **Unplug the power cord from the wall outlet to protect your set during heavy thunderstorms.**
 - ξ **If electric cable is damaged, it must be replaced by manufacturer, or qualified technicians.**
 - ξ **The main plug is used as a disconnect device, the disconnect device shall remain readily operable.**

STEREO HEADPHONE JACK



This system includes a stereo headphone jack on the front panel of the main unit. You may connect a set of stereo headphones (not included) for private listening without disturbing others.

The speakers are muted automatically when headphones are connected. Make sure that the headphone jack is completely inserted. If the headphone jack is not completely inserted, the sound may be intermittent, or you may only hear sound from one side of the headphones.

IMPORTANT: To prevent hearing damage always set the volume control to a low level before you connect the headphones. Then connect the headphones, put them on, and very gradually increase the volume to a comfortable listening level. Remember that CDs may contain both very soft and very loud passages. Adjust the volume to a comfortable level using a louder passage, so that you always know what the maximum level will be.

Operation Instructions

STANDBY Mode

1. To turn on the micro system, press the  button on front panel of the unit or on the remote control.
2. To turn off and switch to standby mode on the micro system, press the  button again.

MUTE BUTTON (On Remote Control Only)

1. You can also press the MUTE button on the remote control to turn off the sound temporarily, for example, when answering the telephone.
2. Press the MUTE button again to cancel the mute function and restore the sound.
3. The mute function will also be cancelled automatically by pressing the VOLUME + or - buttons.

FUNCTION BUTTON or SOURCE BUTTON on Remote Control

Press the FUNCTION/ SOURCE button repeatedly to switch among CD/ FM TUNER/ LINE IN/ BLUETOOTH modes.

Or press CD/ USB direct key from the remote control to select the USB mode or CD MODE

VOLUME LEVEL

Rotate the VOLUME knob on front panel or press VOL +/ VOL - buttons on remote control to adjust the volume level.

TREBLE ADJUSTMENT (On Remote Control Only)

Press TREBLE + or TREBLE - button on remote control to adjust the treble effect.

Treble -



Treble +



BASS ADJUSTMENT (On Remote Control Only)

Press BASS+ or BASS- button on the remote control to adjust the bass effect.

BASS -



BASS +



EQ (On Remote Control Only)

Press the EQ button on the remote control to cycle through the following equalizer settings:

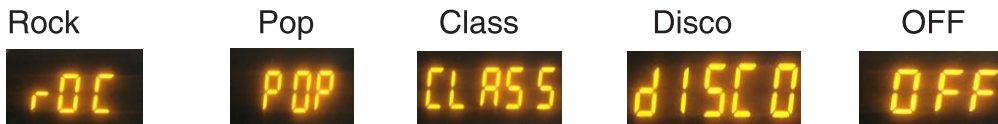

LOUDNESS (On Remote Control Only)



Press 'LOUDNESS' button to enhance the bass level immediately when bass is not enough.





CD OPERATION

You can play your audio CD, CD-R & CD-W with MP3 audio formatted file in this Micro System

Open the disc tray by pressing  EJECT button on the unit or on the remote control.

1. Insert the CD with the printing side facing up and close gently the disc tray by pressing again  EJECT.
2. Press FUNCTION/ SOURCE button on the main unit or remote control to select the CD MODE.
3. Playback will start automatically or press  to start the CD playback.
4. Press  stop button on unit or on remote control to stop playback.

Searching for a section within CDs

During playback, press  /  on the remote control to find a specific passage within the track and release it at the point you want to listen to.

Select another track or file

Press  or  button on the main unit or remote control to select a particular track.

Listening to your tracks (files) repeatedly

1. Press REPEAT button on the remote control repeatedly to activate the REPEAT function in following order:

REPEAT 1  REPEAT ALL  OFF (Note: Off function will not display Off On screen)



Listening to your tracks (files) randomly

Press RANDOM button on the remote control to play tracks in a random order.

A-B function

During CD DISC playback, you can press 'AB' button on remote control to start from the point A (time point you pressed), and ended point B when you press 'AB' button again and music will play repeatedly from A to B.



Intro function

This feature allows you to play the 10 first seconds of each track on the disk.

Load the disc and wait until the display shows the total playing time and number of tracks. Press 'INTRO' button on remote control to activate the function, press again to cancel the function.

Programming to Creating your own playlist

You can play up to 9 tracks on a CD in order.

1. Insert a CD and wait for to be read
2. Press **PROG** button on the remote control in **STOP** status.
3. Press Numeric buttons on the remote control on the remote control to select the track you want to program. Press PLAY button on remote or on front panel of the unit to confirm your selection.
4. Press  on the unit or  on the remote control to play the programmed music files.

About MP3/WMA

MP3/WMA Disc compatibility with this unit is limited as follows: Sampling Frequency: 32-48 (MP3/WMA)

Bit rate: 32-320kbps (MP3), 40-320kbps (WMA) Do not use special letters such as / : * ? < > etc

Even if the total number of files on the disc has more than 1000, it will only be shown up to 999.

FM RADIO /TUNER OPERATION

1. Press FUNCTION/ SOURCE button on the main unit or remote control to select TUNER MODE.
2. Tune to the desired radio station by using FF- / FF+ on the remote control for a manual tuning.
3. For AUTO TUNING, press  button on the unit or SEARCH (11) button on remote control to enter in automatic searching radio station mode.

Hints for Better FM Reception:

The FM lead wire antenna on the back panel should be extended to its full length. You may also have to vary the direction of this antenna until you find the position that provides the best reception.

Preset Radio Stations

You can store up to 30 of your favorite stations in the tuner memory for easy recall at any time.

1. By use of GOTO Button & FF+/FF- button on remote control find frequency station.
2. Press "Memory" button enter into Preset menu, LED display will flash " F_ _ " now enter into preset mode function.
3. Press numeric buttons input the station frequency, for example:1; 10+1; or above etc.
4. After you confirmed station, press Play button to finish Preset operation.
5. By use of CH+/CH- on the remote control to review preset channel stations.

Press GOTO button on remote control, LED will display CH_ _, and press the preset number of the radio station to recall it. For example, press 1 to play the radio station you preset in position 1. If the preset number is above 10, press +10 button on remote control and number key to input second digit preset number.

AUX-IN OPERATION

The unit can be used to play music from external device via 3.5mm Aux-in cable.

1. Connect by using Aux-in Male-to-Male Stereo cable the external device to the Aux-in jack of the unit.
2. If your TV has only one output for audio (MONO). Connect it to the left (white) audio jack on the unit.
3. Press SOURCE on the remote control repeatedly to select the LINE IN MODE.
4. Start playback on the external audio device. Adjust the volume on the audio device (do not set the volume to a high level in order to avoid distortion). You may also adjust the volume on the appliance.
5. To control playback function, use the controls on the external audio device.

USB OPERATION

You can enjoy media files saved on your USB device by connecting the USB device to the USB port of the unit. Kindly remind that the USB can't support charging function.

1. Connect the USB device to the USB port of the unit.
2. In CD mode Select the USB MODE by pressing CD/USB on your remote control
3. Select a file you want to play using **▶▶/◀◀/◀◀/▶▶** or directly thanks to number keys.
4. Press **▶** on remote control or on the unit to start the playback.
5. Turn the VOLUME knob or press VOL+ / VOL- on the remote control to increase or decrease volume level.
6. Press **■** stop button on remote control to stop USB playback.
7. Before disconnecting the USB device, change the source by pressing SOURCE button on remote control

Compatible USB Device:

MP3 player: Flash type MP3 player.

USB Flash Drive: Devices that support USB2.0 or USB 1.1. The USB function may not be available depending on device.

Device which require additional program installation when you have connected it to a computer, are not supported.

Do not unplug the USB device while in operation.

For a large USB capacity, it may take longer than a few minutes to be searched. To prevent data loss, back up all data.

Do not use any USB extension cable or USB hub.

Note:

The maximum size of the Flash Drive that can be supported is up to 32GB. USB is suitable for music playback only. Most of MP3 files are supported and other music formats may not be played.

Smartphone playback via USB cable and encrypted USB devices may not be supported on this unit.

BLUETOOTH OPERATION

This product includes Bluetooth which can wireless play back music from a Bluetooth device.

1. Press the source button on remote control repeatedly to enter Bluetooth mode, the LED will change between red and blue continuously, which means the unit is ready to pair.
2. Enable the Bluetooth function and scan on your Bluetooth device (press reference the device manual for operation), and check the available Bluetooth device on the list.
3. Select “AM-301” for pairing.
4. A short notice sound will come out from the speaker after the Micro System has paired. The LED indicator will then blue.
5. Select and play music from your Bluetooth device.

Notices:

- a. The best working distance of Bluetooth is within 10 meters without any obstacles interfering in between.
- b. The unit can only pair and work with one Bluetooth device at one time.
- c. The unit cannot control Bluetooth device during operation.

Care and Maintenance

Care of Compact Discs

1. Treat the disc carefully. Handle the disc only by its edges. Never allow your fingers to come in contact with the shiny, unprinted side of the disc.
2. Do not attach adhesive tape, stickers, etc. to the disc label.
3. Clean the discs periodically with a soft, lint-free, dry cloth. Never use detergents or abrasive cleaners to clean the disc. If necessary, use a CD cleaning kit. If a disc skips or gets stuck on a section of the disc, it is probably dirty or damaged (scratched). When cleaning the disc, wipe in straight lines from the center of the disc to the outer edge of the disc. Never wipe in circular motions.
4. This unit is designed to play discs bearing the identification logo as shown here or MP3 format Disc. Other discs may not conform to the CD standard and may not play properly.
5. Discs should be stored in their cases after each use to avoid damage.
6. Do not expose discs to direct sunlight, high humidity, high temperatures, or dust, etc. Prolonged exposure or extreme temperatures can warp the disc.
7. Do not stick or write anything on either side of the disc. Sharp writing instruments or the ink may damage the surface.



Care of the Cabinet

1. To prevent fire or shock hazard, disconnect your unit from the AC power source when cleaning.
2. The finish on your unit may be cleaned with a dust cloth and cared for as other furniture. Use caution when cleaning and wiping the plastic parts.
3. Mild soap and a damp cloth may be used on the front panel.

Troubleshooting

If a fault occurs, first check the points listed below before taking the set to repair.

Do not open the set as there is a risk of electric shock. If you are unable to remedy a problem by following these hints, consult your dealer or service center.

WARNING: under no circumstances should you try to repair the set yourself, as this will invalidate the warranty.

Symptom	Cause	Correction
General		
No power	The power cord is not plugged.	Plug in the power cord.
	Check whether electricity failed.	Check the condition by operating other electronic devices.
No sound	Check whether you have selected the right function.	Press SOURCE on the remote control and check the selected function.
CD		
The unit does not start playback	An unplayable disc is inserted	Insert a playable disc
	The disc is dirty	Clean the disc
RADIO		
Radio stations cannot be tuned	The antenna is positioned or connected poorly.	Connect the antenna securely.
Remote control		
The remote control does not work properly	The remote control is too far from the unit.	Operate the remote control within 16ft(5M).
	There is an obstacle in the path of the remote control and the unit.	Remove the obstacle.
	The battery in the remote control is exhausted.	Replace the batteries with new one.

Technical Specifications

MODEL

AM-301

Power supply
Power consumption

AC 110 - 240 V, 50/60 Hz
30 W

RADIO SECTION

Frequency ranges

FM 88 ~ 108 MHz

CD PLAYER

CD / CD-R/ CD-RW / MP3 FORMAT

USB Flash Drive Support

32 GB

AMPLIFIER

Output power BASS

2 x 10W(RMS)

**Multifunction Remote Control Battery:
2X AAA (not included)**

Note: As a result of continual improvements, the design and specifications of the product within may differ slightly to the unit illustrated on the packaging.

DISPOSAL OF ELECTRICAL AND ELECTRONIC EQUIPMENT



This symbol on the product or packaging means that the product should not be treated as household waste. Do not throw garbage at the end of its life, but take it to a collection center for recycling. In this way you will help to protect the environment and be able to prevent any negative consequences that it would have on the environment and human health.

To find your nearest collection center:

-Contact local authorities

- Access the website: www.mmediu.ro

Request additional information from the store where you purchased the product.

AKAI

Microsistem Hi-Fi cu Bluetooth



AM-301W-N



AM-301K-N

Cititi acest manual cu atentie si pastrati-l pentru referinte viitoare

Cuprins

Informatii privind siguranta si atentionari.....	2
Ghidul produsului.....	4
Pornirea.....	7
Instructiuni de operare.....	9
Intretinere.....	14
Depanare.....	15
Specificatii tehnice.....	16

Informatii privind siguranta si atentionari

PERICOL – Indica o situatie periculoasa imediata care, daca nu este evitata, poate duce la deces sau raniri grave. Acest simbol apare in cele mai extreme situatii.

ATENTIONARE – Indica o situatie potential periculoasa care ar putea duce la deces sau raniri grave.

ATENTIE – Indica o situatie potential periculoasa care, daca nu este evitata, poate duce la raniri minore/moderate sau avarieri ale produsului/proprietatii. Atentioneaza, de asemenea, asupra practicilor periculoase.

PENTRU A PREVENI RISCUL DE INCENDIU SAU ELECTROCUTARE, NU EXPUNETI ACEST APARAT LA PLOAIE SAU UMEZEALA.



SIMBOLUL FULGERULUI CU SAGEATA IN VARF -

Intr-un triunghi echilateral, acest simbol atentioneaza utilizatorii de prezenta tensiunii neizolate din interiorul produselor, care poate fi suficient de puternica incat sa constituie risc de electrocutare pentru persoane.



SEMNUL EXCLAMARII -

Intr-un triunghi echilateral se foloseste pentru a indica faptul ca piesele de schimb trebuie inlocuite doar cu alte piese de schimb specificate in documentatie, din motive de siguranta.

Aparatul are urmatoarea eticheta, care contine informatii despre procedura corespunzatoare manevrarii unui aparat cu raze laser:

ATENTIE

PRODUS CU LASER, CLASA 1

Operarea aparatului in alt fel decat cel specificat in prezentul manual sau modificarea acestuia pot duce la expunerea la radiatii periculoase.



PROTECTIE IMPOTRIVA RAZELOR LASER

Acest aparat foloseste raze laser. Doar personalul calificat poate face reparatii.



ATENTIONARE: RISC DE RADIATII LASER CAND CAPACUL CD-ULUI ESTE DESCHIS SAU CAND ACESTA NU SE INCHIDE CORESPUNZATOR. EVITATI EXPUNEREA DIRECTA LA RAZA LASER.

INTRUCIUNI DE SIGURANTA

- 1) Cititi acest manual de instructiuni inainte de a incerca sa conectati sau sa operati aparatul.
- 2) Pastrati aceste instructiuni in bune conditii. Tineti seama de toate atentionarile. Urmati toate instructiunile
- 3) Pastrati acest manual de instructiuni pentru referinte viitoare
- 4) Aparatul nu trebuie udat sau stropit si nu se vor aseza pe acesta obiecte pline cu lichide, cum ar fi vase. Se foloseste doar in locuri uscate.
- 5) Langa aparat nu trebuie asezate surse deschise de foc, cum ar fi lumanari.
- 6) Copiii trebuie supravegheati pentru a va asigura ca nu se joaca cu aparatul.
- 7) Ventilarea nu trebuie impiedicata prin astuparea gurilor de ventilatie.
- 8) Asigurati-va ca aparatul este cuplat la o priza de perete de 220-240V 50Hz. Folosirea unui voltaj mai mare poate duce la defectarea aparatului. Opriti complet aparatul de la sursa de alimentare pentru a-l inchide complet.
- 9) Nu bagati in priza/scoateti din priza cablul de alimentare in/din priza de perete cu mainile ude.
- 10) In cazul in care cablul de alimentare nu se potriveste in priza, nu-l fortati.
- 11) Folositi doar accesorii care sunt specificate de producator.
- 12) Folositi piese de schimb care sunt specificate de producator.
- 13) Instalati aparatul in conformitate cu instructiunile producatorului.
- 14) Asezati aparatul intr-un loc cu ventilatie buna. Asezati sistemul pe o suprafata plata, tare si stabila. Nu expuneti aparatul la temperaturi mai mari de 40°C. Lasati o distanta de cel putin 10 cm in spatele si deasupra aparatului si 5 cm pentru fiecare parte.
- 15) Apasati butoanele usor. Daca le apasati prea puternic este posibil sa avariati aparatul.
- 16) Asigurati-va intotdeauna ca aparatul este scos din priza de perete inainte de a-l muta sau de a-l curata. Curatati aparatul doar cu o carpa uscata.
- 17) Scoateti aparatul din priza in timpul unei furtuni cu fulgere sau atunci cand nu este folosit o perioada mai lunga de timp.
- 18) Acest produs nu contine piese de schimb. Nu incercati sa reparati aparatul singuri. Doar personalul calificat poate efectua service-ul. Duceti aparatul la service pentru inspectie si reparatii.
- 19) Nu lasati NICIODATA pe nimeni, in special pe copii, sa introduca nimic in gauri, fante sau orice alte deschideri ale aparatului, deoarece se pot produce electrocutari.
- 20) Acest aparat se foloseste doar in interior si in locuri uscate.
- 21) Nu lasati aparatul nesupravegheat atunci cand functioneaza.
- 22) Aruncati bateriile doar in conformitate cu regulamentele de protectie a mediului.

NOTA: cand sistemul este comutat in modul standby, acesta consuma energie electrica in continuare. Pentru a deconecta complet sistemul, scoateti cablul de alimentare din priza de perete.

Ghidul aparatului

Panoul frontal

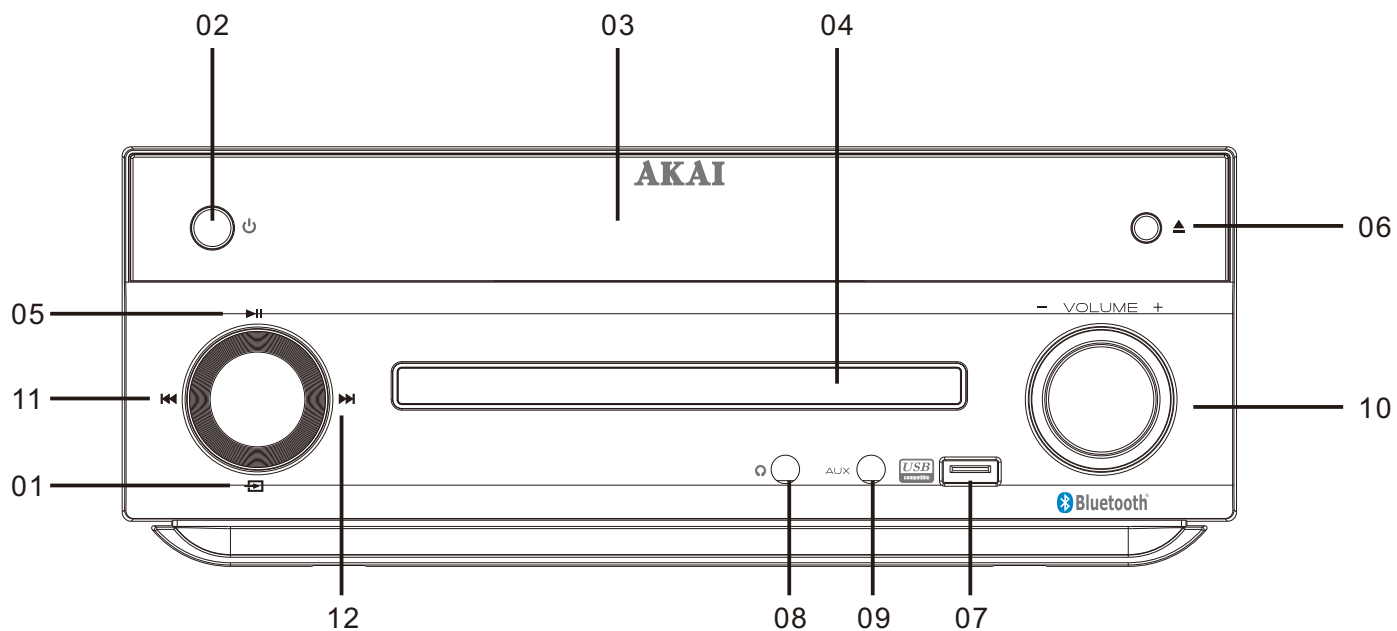

- | | |
|------------------------------|-------------------|
| 1. Source | 7. Port USB |
| 2. Pornire/Oprire alimentare | 8. Mufa casti |
| 3. Afisaj | 9. Mufa Aux |
| 4. Compartiment CD | 10. Control volum |
| 5. Redare/Pauza | 11. Anterior |
| 6. Scoatere CD | 12. Urmator |

Panou spate

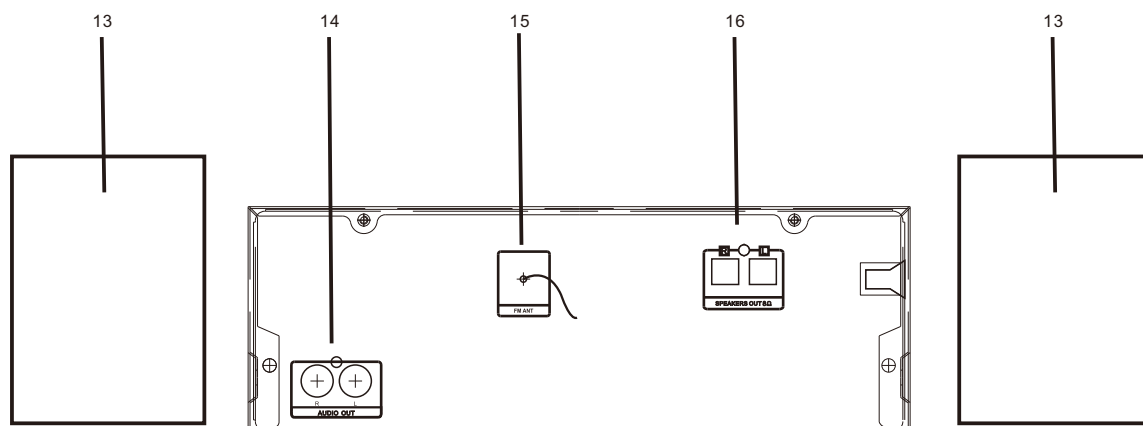

13. Boxa satelit

14. Mufa audio pentru boxa satelit

15. Antena FM

16. Terminal iesire boxa externa

Telecomanda

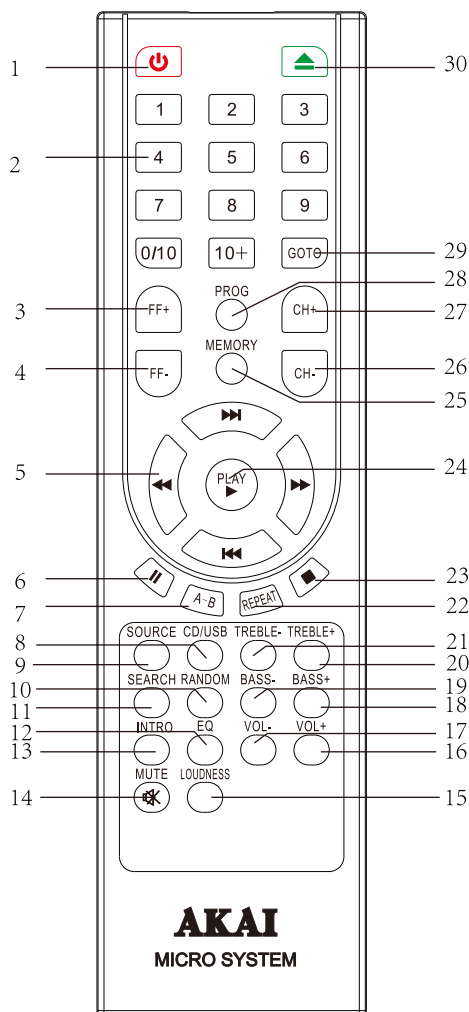

- 1.Standby
- 2.Butoane numerice
- 3-4. Reglare manuala frecventa FM+/-
- 5.Buton anterior/urmator/derulare rapida inainte/derulare rapida inapoi
- 6.Pauza
- 7.A-B
- 8.Mod CD/USB
- 9.Sursa
- 10.Redare aleatorie
- 11.Cautare
- 12.EQ
- 13.Intro
- 14.Fara sunet
- 15.Intensitate zgomot
- 16-17. Volum +/-
- 18-21. Reglare inalte & bass
- 22.Repetare
- 23.Stop
24. Redare
- 25.Memorie
- 26-27. Canal+/-
- 28.Program
- 29.GOTO
- 30.Eject

SENZOR INFRAROSU TELECOMANDA

- Chiar daca telecomanda este folosita in raza de functionare corespunzatoare, operarea acesteia va fi imposibila daca exista obstacole intre aparat si telecomanda.
- Daca telecomanda este folosita in apropierea aparatelor care genereaza raze infrarosii sau daca alte aparate cu telecomanda, care folosesc raze infrarosii sunt utilizate langa aparat, se poate ca acesta sa nu functioneze corect.

INSTALAREA BATERIILOR IN TELECOMANDA

Introduceti baterii de tipul 2 AAA (nu sunt incluse) in compartimentul pentru baterii. Asigurati-va ca bateriile sunt introduse corect, pentru a evita defectarea telecomenzii. Scoateti intotdeauna bateriile cand telecomanda nu este folosita o perioada indelungata de timp, deoarece acestea pot curge si astfel pot defecta telecomanda.

INSTALAREA BATERIEI

Glisati capacul si introduceti bateriile de tip 2 AAA (nu sunt incluse), cu polaritatile conform celor aratate mai jos:

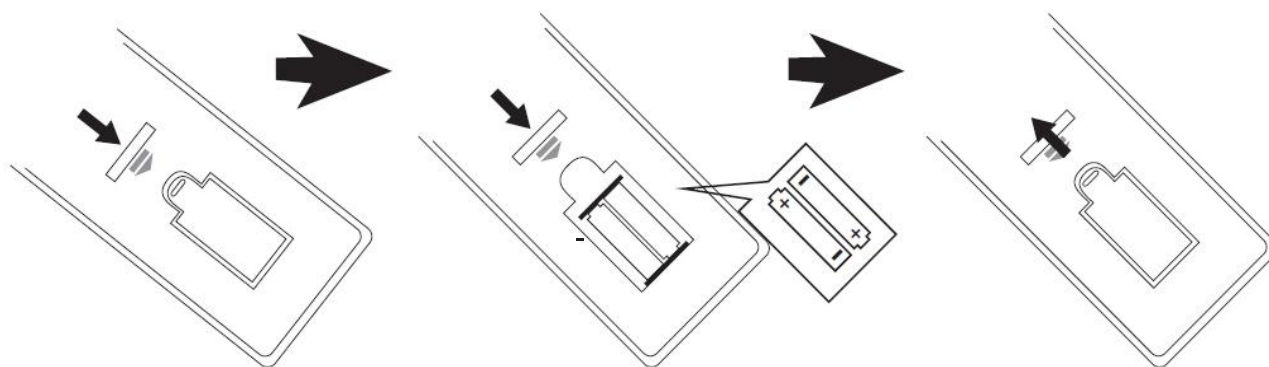

Note:

- Daca distanta necesara dintre telecomanda si aparat scade, inseamna ca bateriile sunt descarcate. In acest caz inlocuiti bateriile cu unele noi.
- Unitatea principala trebuie sa fie in modul standby pentru ca telecomanda sa poata functiona.

Pornirea

PREGATIRI PENTRU UTILIZARE

Despachetarea si pregatirea:

Asigurati-va ca nu uitati sa scoateti ceva din pachet.



AM-301



Telecomanda



Cablu audio 3.5mm



Manual de instructiuni

CONECTARE

1. Verificati daca voltajul, asa cum este specificat pe eticheta de pe spatele aparatului, corespunde sursei locale de curent. In caz contrar, consultati furnizorul local sau centrul de service.
2. Conectati boxa la unitate. Conectati cablurile boxelor la terminalele de pe boxa frontala. Conectati capatul negru al fiecarui fir la terminalul marcat – (minus) si celalalt capat la terminalul marcat + (plus).
3. Conectati cablul de alimentare la priza de perete. Sursa de alimentare este acum conectata si gata de utilizare.

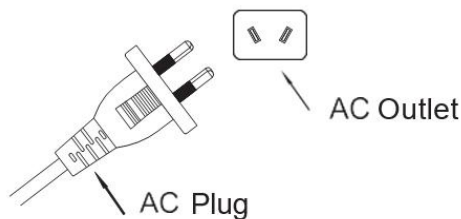

Pentru a opri aparatul complet, opriti sursa principala de curent de la butonul pornire/oprire si scoateti cablul de alimentare din priza de perete.

- ξ **Scoateti cablul de alimentare din priza de perete pentru a proteja aparatul in timpul furtunilor puternice.**
- ξ **In cazul in care cablurile electrice sunt afectate, acestea trebuie inlocuite de producator sau de personalul de service calificat.**
- ξ **Cablul de alimentare este folosit pentru deconectarea aparatului si prin deconectare aparatul va fi inoperabil.**

MUFA CASTI STEREO

Acest sistem include o mufa pentru casti stereo pe panoul frontal al unitatii principale. Puteti conecta un set de casti stereo (nu sunt incluse) pentru a putea asculta muzica in privat, fara a-i deranja pe ceilalti.

Boxele sunt oprite automat atunci cand castile sunt conectate. Asigurati-va ca mufa pentru casti este introdusa complet. Daca mufa pentru casti nu este introdusa complet, sunetul poate fi intermitent sau puteti auzi zgomote externe.

IMPORTANT: Pentru a preveni lezarea auzului, reglati intotdeauna volumul la un nivel minim inainte de a conecta castile. Apoi conectati castile, puneti-le la urechi si mariti volumul gradual pentru un nivel de ascultare confortabil. Tineti cont de faptul ca CD-urile pot contine atat pasaje foarte usoare cat si pasaje foarte zgomotoase. Reglati volumul la un nivel confortabil cu ajutorul unui pasaj zgomotos, pentru a sti intotdeauna care va fi nivelul maxim.

Instructiuni operare

Modul STANDBY

1. Pentru a porni micro-sistemul apăsați butonul  de pe panoul frontal al unității sau de pe telecomandă
2. Pentru a opri sau trece micro-sistemul în modul standby, apăsați din nou butonul .

BUTONUL MUTE (doar de pe telecomandă)

1. Puteti, de asemenea, să apăsați butonul MUTE de pe telecomandă pentru a opri temporar sunetul, de exemplu, atunci când răspundeți la telefon.
2. Apăsați din nou butonul MUTE pentru a anula funcția “mute” și a relua sunetul.
3. Funcția “mute” va fi, de asemenea, anulată automat prin apăsarea butoanelor VOLUME + sau -.

BUTONUL PENTRU FUNCTII sau BUTONUL PENTRU SURSA de pe telecomandă

Apăsați în mod repetat butonul FUNCTION/ SOURCE pentru a comuta între modurile CD/ FM TUNER/ LINE IN/ BLUETOOTH.

Sau apăsați direct butonul CD/ USB de pe telecomandă pentru a selecta modul USB sau CD.

NIVELUL VOLUMULUI

Rotiți butonul pentru VOLUME de pe panoul frontal sau apăsați butoanele VOL +/ VOL – de pe telecomandă pentru a regla nivelul volumului.

REGLAREA INALTELOR (doar de pe telecomandă)

Apăsați butonul TREBLE + sau TREBLE – de pe telecomandă pentru a regla efectul înalțelor.

Treble -



Treble +



REGLAREA BASS-ului (doar de pe telecomandă)

Apăsați butonul BASS+ sau BASS- de pe telecomandă pentru a regla efectul bass-ului.

BASS -



BASS +



EQ (doar de pe telecomandă)

Apăsați butonul EQ de pe telecomandă pentru a parcurge următoarele setări ale egalizatorului:

Rock

ROCK

Pop

POP

Class

CLASS

Disco

DISCO

OPRIT

OFF

INTENSITATEA SUNETULUI (doar de pe telecomanda)

Apasati butonul 'LOUDNESS' pentru a mari nivelul bass-ului atunci cand acesta nu se aude suficient.

Pornire intensitate sunet

LOUD ON



Oprire intensitate sunet

LOUD OFF



OPERARE CD

La acest micro-sistem puteti reda CD, CD-R & CD-W cu fisiere audio MP3.

Deschideti compartimentul pentru disc prin apasarea butonului  EJECT de pe aparat sau de pe telecomanda.

1. Introduceti CD-ul cu fata printata in sus si inchideti usor compartimentul, din nou prin apasarea butonului  EJECT.
2. Apasati butonul FUNCTION/ SOURCE de pe unitatea principala sau de pe telecomanda, pentru a selecta MODUL CD.
3. Redarea va incepe automat sau apasati  pentru a porni redarea CD-ului.
4. Apasati butonul stop  de pe unitate sau de pe telecomanda pentru a opri redarea.

Cautarea unui fragment in CD

In timpul redarii, apasati  /  de pe telecomanda, pentru a gasi un anumit fragment dintr-o piesa si eliberati butonul la punctul de la care doriti redarea.

Selectarea unei alte melodii sau altui fisier

Apasati butonul  sau  de pe unitatea principala sau telecomanda pentru a selecta o anumita melodie.

Ascultati in mod repetat melodiile (fisierele)

1. Apasati in mod repetat butonul REPEAT de pe telecomanda pentru a activa functia REPEAT, in urmatoarea ordine:

REPEAT 1  REPEAT ALL  OFF (Nota: Functia Off nu va afisa mesajul Off pe ecran)

REP ONE

REP ALL

Ascultarea aleatorie a melodiilor (fisierele)

Apasati butonul RANDOM de pe telecomanda pentru a reda fisierele intr-o ordine aleatorie.

Funcția A-B



In timpul redarii discului CD, puteti apasa butonul 'AB' de pe telecomanda pentru a incepe din punctul A (punctul de pornire pe care l-ati apasat) si a termina in punctul B, dupa care apasarea repetata a butonului 'AB' va duce la redarea repetata de la A la B.

Funcția Intro

Aceasta caracteristica permite redarea primelor 10 secunde de la fiecare melodie de pe disc. Introduceti discul si asteptati pana cand afisajul arata timpul total de redare si numarul pieselor. Apasati butonul "INTRO" de pe telecomanda pentru a activa functia, apasati din nou pentru a anula functia.

Programarea pentru crearea propriei liste de redare

Puteti reda pana la 9 piese de pe CD, in ordine.

1. Introduceti un CD si asteptati ca acesta sa fie citit.
2. Apasati butonul **PROG** de pe telecomanda in modul **STOP**.
3. Apasati butoanele numerice de pe telecomanda pentru a selecta melodia pe care doriti sa o programati. Apasati butonul PLAY de pe telecomanda sau de pe panoul frontal al aparatului pentru a confirma selectia.
4. Apasati  de pe unitate sau  de pe telecomanda pentru a reda fisierele programate.

Despre MP3/WMA

Compatibilitatea discului MP3/WMA cu aceasta unitate este limitata dupa cum urmeaza: Frecventa de esantionare: 32-48 (MP3/WMA)

Rata de biti: 32-320kbps (MP3), 40-320kbps (WMA) Nu folositi caractere speciale, cum ar fi / : * ? < > etc.

Chiar daca numarul total al fisierele de pe disc este mai mare de 1000, aparatul va afisa doar pana la 999.

OPERAREA RADIO FM / REGLAREA PROGRAMELOR

1. Apasati butonul FUNCTION/ SOURCE de pe unitatea principala sau telecomanda pentru a selecta MODUL TUNER.
2. Reglati postul de radio dorit prin folosirea butoanelor FF- / FF+ de pe telecomanda, pentru reglare manuala.
3. Pentru REGLARE AUTO, apasati butonul  de pe unitate sau butonul SEARCH (11) de pe telecomanda pentru a intra automat in modul de cautare al posturilor de radio.

Sfaturi pentru o mai buna receptie FM:

Antena FM aflata pe panoul spate, trebuie extinsa la maxim. De asemenea, ar putea fi necesara schimbarea directiei antenei pana cand aceasta obtine cea mai buna receptie.

Presetarea posturilor de radio

Puteti memora pana la 30 de posturi de radio preferate in memoria aparatului pentru a le gasi usor de fiecare data.

1. Prin folosirea butonului GOTO & FF+/FF- de pe telecomanda, gasiti frecventa postului de radio.
2. Apasati butonul "Memory" pentru a intra in meniul Preset, iar afisajul LED va licari mesajul " F_ _" pentru a intra in modul de presetare.
3. Apasati butoanele numerice pentru a introduce frecventa postului de radio; de exemplu: 1; 10+1; sau mai mare etc.
4. Dupa ce ati confirmat postul de radio, apasati butonul Play pentru a finaliza operatia de presetare.
5. Folositi butoanele CH+/CH- de pe telecomanda pentru a revizui posturile de radio presetate.

Apasati butonul GOTO de pe telecomanda, iar afisajul LED va arata mesajul CH_ _, apoi apasati numarul presetat al postului de radio pentru a-l revizui. De exemplu, apasati 1 pentru a reda postul de radio pe care il presetati la pozitia 1. Daca numarul presetat este mai mare de 10, apasati butonul +10 de pe telecomanda si tastele numerice pentru a introduce a doua cifra a numarului presetat.

OPERAREA AUX-IN

Aparatul poate fi folosit pentru a reda muzica din dispozitive externe, prin cablu Aux-in 3.5mm.

1. Connect by using Aux-in Male-to-Male Stereo cable the external device to the Aux-in jack of the unit.
2. Daca TV-ul are doar o iesire pentru audio (MONO), conectati-l la mufa audio stanga (alba) a aparatului.
3. Apasati in mod repetat SOURCE de pe telecomanda, pentru a selecta MODUL LINE IN.
4. Porniti redarea de pe dispozitivul audio extern. Reglati volumul dispozitivului audio (nu setati volumul la un nivel ridicat pentru a evita distorsiunea sunetului). Puteti, de asemenea, sa reglati volumul aparatului.
5. Pentru a controla functia de redare, folositi butoanele dispozitivului audio extern.

OPERAREA USB

Puteti sa va bucurati de fisierele media salvate pe dispozitivul USB prin conectarea acestuia la portul aflat pe aparat. Va reamintim ca mufa USB nu functioneaza ca incarcator.

1. Conectati dispozitivul USB la portul USB al unitatii.
2. In modul CD selectati MODUL USB prin apasarea butonului CD/USB de pe telecomanda.
3. Selectati un fisier pe care doriti sa-l redati, prin folosirea butoanelor ►►/◀◀/◀◀/►► sau direct cu tastele numerice.
4. Apasati  de pe telecomanda sau de pe unitate pentru a porni redarea.
5. Rotiti butonul VOLUME sau apasati butonul VOL+ / VOL- de pe telecomanda pentru a mari sau mica nivelul volumului.
6. Apasati butonul stop ■ de pe telecomanda pentru a opri redarea USB.
7. Inainte de a deconecta dispozitivul USB, schimbati sursa prin apasarea butonului SOURCE de pe telecomanda.

Dispozitiv USB compatibil:

Player MP3: Stick pentru player MP3.

Stick USB: Dispozitive care suporta USB2.0 sau USB 1.1. Functia USB poate fi nefunctionala in functie de dispozitiv.

Nu sunt compatibile dispozitivele care necesita instalare suplimentara a programului atunci cand este conectat la un calculator.

Nu scoateti dispozitivul USB in timpul operarii.

Pentru un USB cu o capacitate de stocare mai mare, cautarea poate dura mai mult de cateva minute. Pentru a preveni pierderea de date, faceti copii de rezerva pentru toate datele.

Nu folositi cabluri USB sau hub USB.

Nota:

Marimea maxim a stick-ului care poate fi citit este de pana la 32GB. USB-ul este folosit doar pentru redarea muzicii. Majoritatea fisierelor MP3 sunt acceptate, dar nu se pot reda alte formate de muzica.

Redarea de pe telefonul mobil prin cablul USB si dispozitive USB criptate nu sunt posibile de pe acest aparat.

OPERAREA BLUETOOTH

Acest produs include Bluetooth, care poate reda muzica wireless dintr-un dispozitiv Bluetooth.

1. Apasati in mod repetat butonul sursa de pe telecomanda pentru a intra in modul Bluetooth, afisajul LED se va schimba continuu intre rosu si albastru, ceea ce inseamna ca aparatul este gata de imperechere.
2. Activati functia Bluetooth si scanati pe dispozitivul cu Bluetooth (vezi manualul dispozitivului pentru operare) si verificati daca dispozitivul cu Bluetooth este disponibil pe lista.
3. Selectati "AM-301" pentru imperechere.
4. Boxa va scoate un sunet scurt de notificare dupa ce micro sistemul a fost imperecheat. Afisajul LED se va face albastru.
5. Selectati si redati muzica din dispozitivul cu Bluetooth.

Notificari:

- a. Cea mai buna distanta de operare pentru Bluetooth este de maxim 10 metri, fara niciun obstacol.
- b. Aparatul se poate imperechea si poate functiona cu un singur aparat cu Bluetooth pe rand.
- c. Aparatul nu poate controla dispozitivul cu Bluetooth in timpul operarii.

Intretinere

Intretinerea Compact Discurilor

1. Manevrati discul cu grija. Tineti discul de margini. Nu atingeti niciodata cu degetele partea lucioasa, netiparita a discului.
2. Nu puneti banda adeziva, stickere etc. pe eticheta discului.
3. Curatati discurile periodic cu o carpa moale, uscata, fara scame. Nu folositi niciodata detergent sau substante abrazive de curatare pentru a curata discul. Daca este necesar, folositi un kit de curatare pentru CD-uri. Daca un disc sare sau se blocheaza pe o portiune, probabil ca este murdar sau avariat (zgariat). Cand curatati discul, stergeti in linii drepte, din centrul discului inspre marginile acestuia. Nu stergeti niciodata cu miscari circulare.
4. Acest aparat este proiectat sa redea discuri care au logo de identificare, dupa cum se arata aici sau discuri pentru format MP3. Alte discuri pot fi neconforme cu standardele pentru CD si pot functiona necorespunzator.
5. Discurile trebuie puse in carcasele lor dupa fiecare utilizare, pentru a evita avarierea acestora.
6. Nu expuneti discurile direct la lumina soarelui, umiditate ridicata, temperaturi ridicate etc. expunerea prelungita sau temperaturile extreme pot sterge discul.
7. Nu lipiti si nu scrieti nimic pe nici una din partile discului. Instrumentele de scris ascutite sau cerneala pot avaria suprafata.



Ingrijirea aparatului

1. Pentru a preveni incendiile sau electrocutarea deconectati unitatea de la sursa de alimentare atunci cand il curatati
2. Finisajele de pe aparat pot fi curatate cu o carpa de praf si ingrijite ca orice alta mobile. Stergeti si curatati cu grija piesele de plastic.
3. Pentru panoul frontal puteti folosi o carpa moale si sapun delicat.

Depanare

Daca apare o eroare, intai verificati punctele mentionate mai jos inainte de a duce aparatul la reparat.

Nu deschideti setul, deoarece exista riscul de electrocutare. Daca nu puteti remedia problema cu ajutorul sfaturilor urmatoare, consultati dealerul sau centrul de service.

ATENTIONARE: in niciun caz nu incercati sa reparati singuri aparatul, deoarece acest lucru poate duce la pierderea garantiei.

Simptom	Cauza	Corectie
General		
Fara curent	Cablul de alimentare nu este conectat.	Conectati cablul de alimentare.
	Verificati daca nu este vreo pana de curent.	Verificati starea prin operarea altor dispozitive electronice.
Fara sunet	Verificati daca ati selectat functia corecta.	Apasati butonul SOURCE de pe telecomanda si verificati functia selectata
CD		
Aparatul nu porneste in modul de redare	Este introdus un disc neoperabil	Introduceti un disc operabil
	Discul e murdar	Curatati discurul
RADIO		
Posturile de radio nu pot fi reglate	Antena nu este pozitionata sau conectata corespunzator.	Conectati antena in siguranta.
Telecomanda		
Telecomanda nu functioneaza corespunzator	Telecomanda este prea departe de aparat.	Folositi telecomanda la o distanta maxima de 5m.
	Exista un obstacol intre telecomanda si aparat.	Eliminati obstacolul.
	Bateria din telecomanda este epuizata.	Inlocuiti bateriile cu unele noi.

Specificatii tehnice

MODEL

Sursa alimentare
Putere consum

AM-301

AC 110 - 240 V, 50/60 Hz
30 W

SECTIUNEA RADIO

Game de frecventa

FM 88 ~ 108 MHz

CD PLAYER

Stick USB

FORMAT CD / CD-R/ CD-RW / MP3

32 GB

AMPLIFICATOR

Putere iesire BASS

2 x 10W(RMS)

Functionarea defectuoasa a telecomenzii:

2X AAA (nu sunt incluse)

Nota: Ca rezultat al imbunatatirii continue, design-ul si specificatiile produsului pot diferi de aparatul afisat pe colet.

DEZAFECTAREA ECHIPAMENTELOR ELECTRICE ȘI ELECTRONICE UZATE



Acest simbol prezent pe produs sau pe ambalaj semnifică faptul că produsul respectiv nu trebuie tratat ca un deșeu menajer obișnuit. Nu aruncați aparatul la gunoiul menajer la sfârșitul duratei de funcționare, ci duceți-l la un centru de colectare autorizat pentru reciclare. În acest fel veți ajuta la protejarea mediului înconjurător și veți putea împiedica eventualele consecințe negative pe care le-ar avea asupra mediului înconjurător și veți putea împiedica eventualele consecințe negative pe care le-ar avea asupra mediului și sănătății umane.

Pentru a afla adresa celui mai apropiat centru de colectare:

- Contactați autoritățile locale;
- Accesați pagina de internet: www.mmediu.ro;

Solicitați informații suplimentare de la magazinul de unde ați achiziționat produsul.