

**DAEWOO**

*edition-1*

# MICROWAVE OVEN

KOR-616T

OPERATING  
INSTRUCTIONS

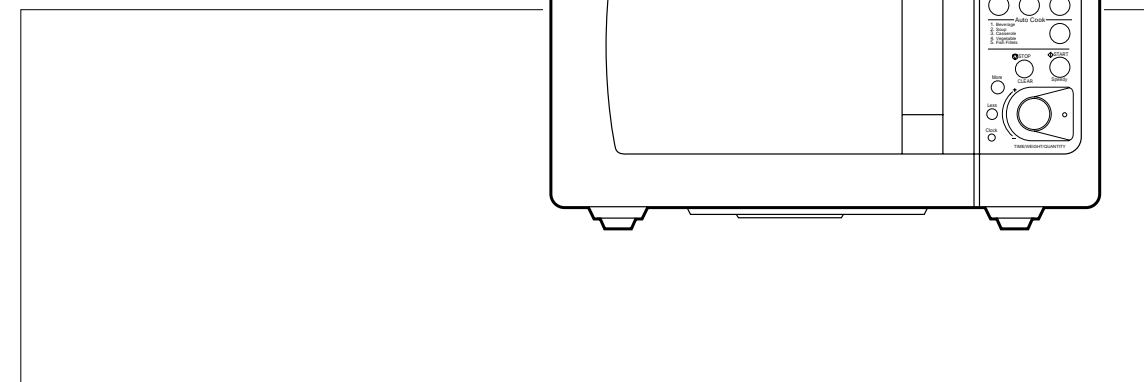

Before operating this oven, please read these instructions completely.

## PRECAUTIONS TO AVOID POSSIBLE EXPOSURE TO EXCESSIVE MICROWAVE ENERGY

- (a) **Do not attempt to operate this oven with the door open** since open-door operation can result in harmful exposure to microwave energy. It is important not to defeat or tamper with the safety interlocks.
- (b) **Do not place any object** between the oven front face and the door or allow soil or cleaner residue to accumulate on sealing surfaces.
- (c) **Do not operate the oven** if it is damaged. It is particularly important that the oven door close properly and that there is no damage to the: (1) door (bent), (2) hinges and latches (broken or loosened), (3) door seals and sealing surfaces.
- (d) **The oven should not be adjusted or repaired** by anyone except properly qualified service personnel.

## TABLE OF CONTENTS

PRECAUTIONS TO AVOID POSSIBLE EXPOSURE TO EXCESSIVE MICROWAVE ENERGY .....	1
TABLE OF CONTENTS .....	1
EARTHING INSTRUCTIONS .....	2
INSTALLATION .....	2
SPECIFICATIONS .....	3
IMPORTANT .....	3
SAFETY INSTRUCTIONS FOR GENERAL USE .....	4
FEATURES DIAGRAM .....	5
CONTROL PANEL .....	6
HOW TO SET THE OVEN CONTROLS .....	7
CLOCK .....	7
TIME DEFROST .....	9
WEIGHT DEFROST .....	8
COOKING IN ONE STAGE .....	10
COOKING IN TWO STAGES .....	11
AUTO COOK .....	13
SPEEDY COOK .....	15
CHILD SAFETY LOCK .....	15
TO STOP THE OVEN WHILE THE OVEN IS OPERATING .....	16
GENERAL GUIDELINES .....	17
COOKING UTENSILS .....	18
CARE AND CLEANING .....	18
BEFORE YOU CALL FOR SERVICE .....	19
QUESTIONS AND ANSWERS .....	20

## EARTHING INSTRUCTIONS

This appliance must be earthed. In the event of an electrical short circuit, earthing reduces the risk of electric shock by providing an escape wire for the electric current. This appliance is equipped with a cord having a earthing wire with a earthing plug. The plug must be plugged into an outlet that is properly installed and earthed.

**WARNING:** Improper use of the earthing plug can result in a risk of electric shock. Consult a qualified electrician or serviceman if the earthing instructions are not completely understood, or if doubt exists as to whether the appliance is properly earthed. If it is necessary to use an extension cord, use only a 3-wire extension cord that has a 3-blade earthing plug, and a 3-slot receptacle that will accept the plug on the appliance. The marked rating of the extension cord should be equal to or greater than the electrical rating of the appliance.

## INSTALLATION

- 1 Steady, flat location**  
This oven should be set on a steady, flat surface. This oven is designed for counter top use only.
- 2 Leave space behind and side**  
All air vents should be kept a clearance. If all vents are covered during operation, the oven may be overheated and, eventually, failed.
- 3 Away from radio and TV sets**  
Poor television reception and radio interference may result if the oven is located close to a TV, Radio antenna, feeder and so on.  
Position the oven, as far from them as possible.
- 4 Away from heating appliance and water taps**  
Keep the oven away from hot air, steam or splash when choosing a place to position it, or the insulation might be adversely affected and breakdowns occur.
- 5 Power supply**
  - Check your local power source. This oven requires a current of approximately 6 amperes, 230V 50Hz.
  - Power supply cord is about 1.1 meters long.
  - The voltage used must be the same as specified on this oven. Using a higher voltage may result in a fire or other accident causing oven damage. Using low voltage will cause slow cooking. We are not responsible for damage resulting from use of this oven with a voltage of ampere fuse other than those specified.
  - This appliance is supplied with cable of special type, which, if damaged, must be repaired with cable of same type. Such a cable can be purchased from DAEWOO and must be installed by a Qualified Person.
- 6 Examine the oven after unpacking for any damage such as:**  
A misaligned door, Broken door, A dent in cavity. If any of the above are visible, DO NOT INSTALL, and notify dealer immediately.
- 7 Do not operate the oven if it is colder than room temperature.**  
(This may occur during delivery in cold weather.) Allow the oven to become room temperature before operating.

## SPECIFICATIONS

POWER SUPPLY		230V~50Hz, SINGLE PHASE WITH EARTHING
MICROWAVE	POWER CONSUMPTION	1200 W
	OUTPUT POWER	800 W(IEC 705)
	FREQUENCY	2450MHz
OUTSIDE DIMENSIONS (W X H X D)		465 X 274 X 379 mm
CAVITY DIMENSIONS (W X H X D)		290 X 200 X 290 mm
NET WEIGHT		APPROX. 13.5 Kg
TIMER		60 min.
POWER SELECTIONS		5 LEVELS

\* Specifications subject to change without notice.

## IMPORTANT

The wires in this mains lead are coloured in accordance with the following code.

Green-and-yellow : Earth  
 Blue : Neutral  
 Brown : Live

As the colours of the wires in the mains lead of this appliance may not correspond with the coloured markings identifying the terminals in your plug, proceed as follows:

The wire which is coloured green-and-yellow must be connected to the terminal in the plug which is marked with the letter 'E' or by the earth symbol or green-and-yellow. The wire which is coloured blue must be connected to the terminal which is marked with the letter 'N' or coloured black.

The wire which is coloured brown must be connected to the terminal which is marked with the letter 'L' or coloured red.

**WARNING:** This appliance must be earthed.

## SAFETY INSTRUCTIONS FOR GENERAL USE

Listed below are, as with all appliances, certain rules to follow and safeguards to assure top performance from this oven:

1. Do not use the oven for any reason other than food preparation, such as for drying clothes, paper, or any other nonfood items or for sterilizing purposes.
2. Do not use the oven when empty, this could damage the oven.
3. Do not use the oven cavity for any type of storage, such as papers, cookbook, cookware, etc.
4. Do not operate the oven without the glass tray in place. Be sure it is properly sitting on the rotating base.
5. Make sure you remove caps or lids prior to cooking when you cook food sealed in bottles.
6. Do not put foreign material between the oven surface and door. It could result in excessive leakage of microwave energy.
7. Do not use recycled paper products for cooking. They may contain impurities which could cause sparks and/or fires when used during cooking.
8. Do not pop popcorn unless popped in a microwave approved popcorn popper or unless it's commercially packaged and recommended especially for microwave ovens. Microwave popped corn produces a lower yield than conventional popping; there will be a number of unpopped kernels. Do not use oil unless specified by the manufacturer.
9. Do not cook any food surrounded by a membrane, such as egg yolks, potatoes, chicken livers, etc., without first piercing them several times with a fork.
10. Do not pop popcorn longer than the manufacturer's directions. (popping time is generally below 3 minutes).  
 Longer cooking does not yield more popped corn, it can cause scorchings and fire.  
 Also, the cooking tray can become too hot to handle or may break.
11. Should the microwave oven emit smoke in quantity to indicate a fire, keep the oven door shut, switch the appliance off and disconnect the mains lead from the outlet.
12. When flammable food containers are used in the oven (e.g. packet popcorn) be sure to check the cooking process periodically in case fire has occurred.
13. Always stir and/or shake the containers of baby foods prior to testing their temperature and serving the contents.
14. Always test the temperature of food or drink which has been heated in a microwave oven before you give it to somebody, especially to children or elderly people. This is important because things which have been heated in a microwave oven carry on getting hotter even though the microwave oven cooking has stopped.

## FEATURES DIAGRAM

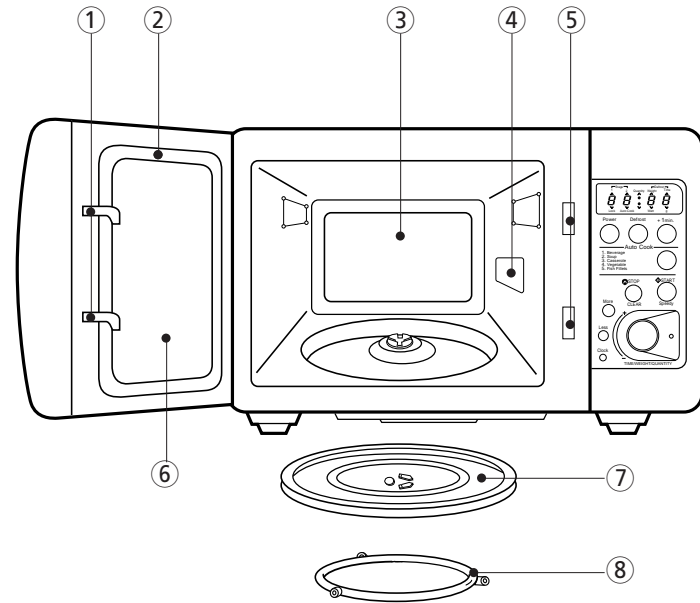

- ① **Door latch** - When the door is closed it will automatically lock shut. If the door is opened while the oven is operating, magnetron will immediately stop operating.
- ② **Door seal** - Door seal maintains the microwave energy within the oven cavity and prevents microwave leakage.
- ③ **Oven cavity.**
- ④ **Spatter shield** - Protects the microwave outlet from splashes of cooking foods.
- ⑤ **Safety interlock system.**
- ⑥ **Door viewing screen** - Allows viewing of food. The screen is designed so that light can pass through, but not the microwaves.
- ⑦ **Glass cooking tray** - Made of special heat resistant glass. Food in a proper receptacle is placed on this tray for cooking.
- ⑧ **Roller guide** - This must always be used for cooking together with the glass cooking tray.

## CONTROL PANEL

When blinking, the oven is in AUTOCOOK quantity input mode.

When blinking, the oven is operating in MICROWAVE mode.

When blinking, the oven is operating in CHILD SAFETY LOCK mode.

When blinking, the oven is operating in AUTO COOK.

**Function buttons**-Used to select desired oven operation. :MICROWAVE, AUTOCOOK, DEFROST.

When blinking, the oven is in WEIGHT DEFROST.

When blinking, the oven is operating in TIME DEFROST.

When blinking, the oven is operating in weight input mode.

When blinking, the oven is in MICROWAVE output power setting mode.

**+1 min. button**-Used to increase time of operating.

**Stop/clear button**-Used to pause or clear all information manually put into the oven control panel except clock.

**Start button**-Used to start a selected operation. When lamp blinks, press the start button.

**Speedy cook button**-Used to set desired time. (It is increased 30 seconds.)

**Guide lamp**-When blinking, it informs you to be ready to operate dial knob.

**Dial knob**-Used to set the cooking time, weight and quantity.

**More/Less button**-Used to select auto cook time. (More/Less 10% of auto cook time)

**Clock button**-Used to set and recall the time of day.

# HOW TO SET THE OVEN CONTROLS

- Tips:**
- Be sure to read the cookbook's introduction before operating the oven.
  - Also remember to read this operating instruction for proper safety information and instruction before using the oven.
  - See the cookbook for specific recipes.
  - Prior to setting the controls, place one cup of water in the oven, in a heat-proof glass measuring cup, for testing purposes.
  - When setting the controls, everytime a button is pressed, a beep can be heard.
  - If you don't take off the food after end cooking, buzzer will sound as 1 minute.

## CLOCK

- NOTE:**
- When the oven is plugged in, "0:00" appears in the display window.
  - The two dots between the hour and minute are the clock indicator lights. They will start to flash on and off.
  - The time of day will be displayed at all times, except when the oven is operating.
  - In the oven of a power failure or if the oven is unplugged, the clock will have to be reset for the proper time. Once power is restored or oven is plugged in, the display will show "0:00".
  - To reset the time of day, repeat the steps given below.
  - To check the time of day while the oven is operating, press the CLOCK button, then the time will be displayed for 3 seconds.
  - When you turn DIAL KNOB, minutes are increased by to turn right and hours are increased as to turn left.

## SETTING THE CONTROL

1. Press CLOCK button.  
If you push the CLOCK button once again, you can select 12 hour clock system.  
Then guide lamp will starts blinking.

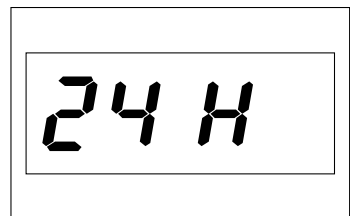

This example is 24 hour clock system.

- NOTE:** This oven is multiple clock system.

- NOTE:** If you are not setting current time for 3 seconds, display return to old time.

2. Turn left the DIAL KNOB for hour you want.

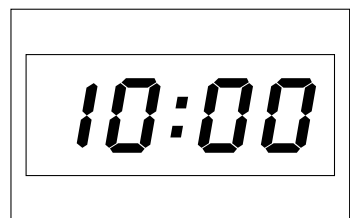

- NOTE:**
- If you selected 12 hour clock system, this digital clock allows you to set from 1:00 to 11:59.
  - If you selected 24 hour clock system, this digital clock allows you to set from 0:00 to 23:59.
  - The colon will stop blinking.

3. Turn right the DIAL KNOB for minute you want.

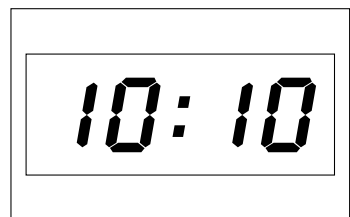

4. Press CLOCK button.

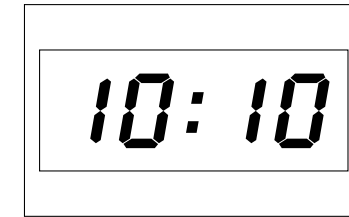

The display will show present time, and the colon starts blinking. This digital clock allows you to set to "10:10"

## TIME DEFROST

### SETTING THE CONTROL

1. Press DEFROST button twice.

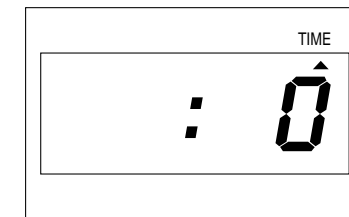

The TIME DEFROST indicator light will light up.

2. Turn the DIAL KNOB for the desired defrosting time.

**For example:** 20 minutes.

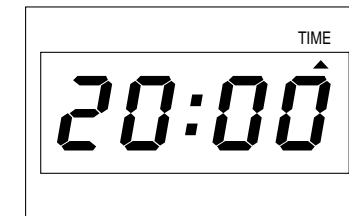

20:00 will show in the display.

- NOTE:** Time can be set up to 60 minutes.

3. Press  $\diamond$  button.

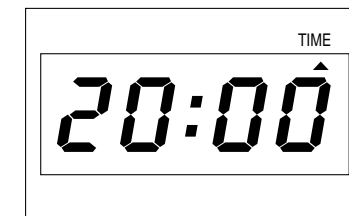

The TIME DEFROST indicator light will start blinking to show the oven is in TIME DEFROST mode.

4. Buzzer will sound at the end of the cooking time. The indicator light will go off. The display panel will return to the time of day. The oven light will turn off and the turntable will stop turning.

- NOTE:** During the defrosting operation, turn over after buzzer sound for completed defrosting.

## WEIGHT DEFROST

**NOTE:** • This digital weight allows you set from 200g to 3000g.  
 • Whenever you press this button, the display is circulated WEIGHT DEFROST, TIME DEFROST, and MICROWAVE mode.

### SETTING THE CONTROL

1. Press DEFROST button once

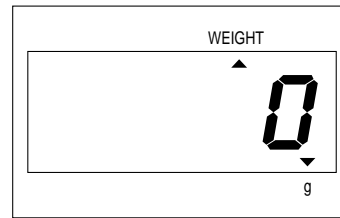

The WEIGHT DEFROST indicator light will come on.  
 The g indicator light will start blinking.

2. Turn the DIAL KNOB for the desired defrosting weight

For example: 1000g

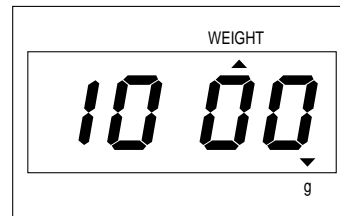

The 1000 will show in the display  
 This display represent 1000g.

3. Press  $\diamond$  button

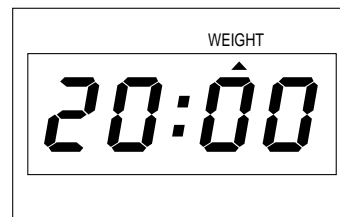

The WEIGHT DEFROST indicator light will starts blinking to show the oven is in WEIGHT DEFROST mode.

4. Buzzer will sound at the end of the cooking time. The indicator light will go off. The display panel will return to the time of day. The oven light will turn off and the turntable will stop turning.

**NOTE:** During the defrosting operation, turn over the food after buzzer sound for completed defrosting.

## COOKING IN ONE STAGE

**NOTE:** • To insure the best microwave and defrost results, be sure to start with a cool oven.  
 Let the oven cool 15~20 minutes with the door slightly open.  
 • Power levels are 800W,650W, 450W, 300W and 140W.  
 • It is displayed after an interval of 10 seconds from 10 seconds to 5 minutes, 30 seconds from 5 minutes to 10 minutes, 1 minute from 10 minutes to 60 minutes.

### SETTING THE CONTROL

1. Press POWER button  
 By repeatedly pressing this button, you can also select other power levels.

For example: 800WATT

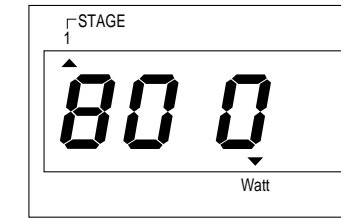

The STAGE1 indicator light will light  
 The WATT indicator light start blinking.

2. Turn the DIAL KNOB for the desired cooking time.

For example: 10minutes

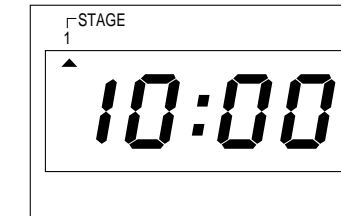

10:00 will show in the display.

**NOTE:** Time can be set up to 60 minutes.

3. Press  $\diamond$  button

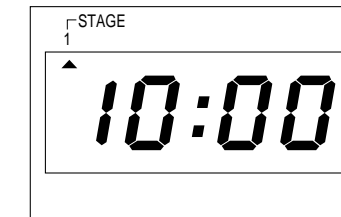

The STAGE1 indicator light will starts blinking to show the oven is in the MICROWAVE mode

4. Buzzer will sound at the end of the cooking time. The indicator light will go off. The display panel will return to the time of day. The oven light will turn off and the turntable will stop turning.

## COOKING IN TWO STAGES

**NOTE:** For best results, some recipes call for one power level for a certain length of time and another power level for a different length of time.

### SETTING THE CONTROL

1. Press POWER button more than three times.  
By repeatedly pressing this button, you can also select other power levels.

**For example:** 450 WATT

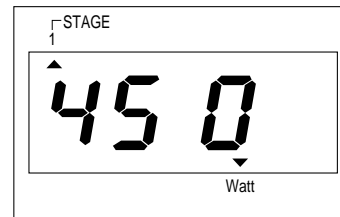

The STAGE1 indicator light will light.  
The WATT indicator light start blinking.

2. Turn the DIAL KNOB for the desired cooking time.

**For example:** 10 minutes

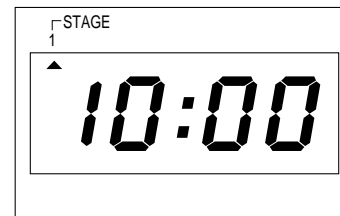

100 will show in the display.

**NOTE:** Time can be set up to 60 minutes.

3. Press POWER button  
By repeatedly pressing this button, you can also select other power levels.

**For example:** 800 WATT

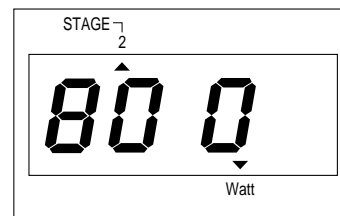

The STAGE2 indicator light will light  
The WATT indicator start blinking.

4. Turn the DIAL KNOB for the desired cooking time.

**For example:** 18minutes

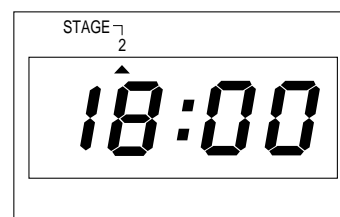

18:00 will show in the display.

**NOTE:** Time can be set up to 60 minutes.

5. Press  $\diamond$  button.

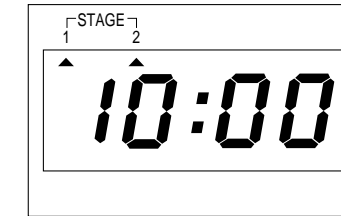

When you touch START, both STAGE1 & 2 indicator lights come on.  
STAGE1 indicator light blinking to show you that the oven is cooking in the first of two cook stages.  
The oven will cook at the power you selected for stage 1.

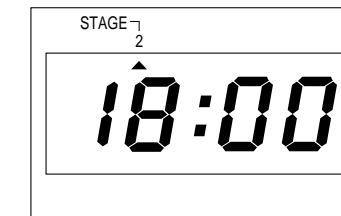

At the end of stage one, the oven will beep and start the second stage two.  
The STAGE1 indicator light will go off and the STAGE2 indicator light starts blinking. The display counts down the time to show you how much cooking time is left in the second stage.

6. Buzzer will sound at the end of the cooking time. The indicator light will go off. The display panel will return to the time of day. The oven light will turn off and the turntable will stop turning.

## AUTO COOK

**NOTE:** • There is programmed for cooking of five kinds (1~5).  
• You don't have to worry about setting time, power and function.

### SETTING THE CONTROL

You can operate MORE or LESS than programmed time as pressing MORE or LESS button whenever MORE or LESS button, display is changed "10" or "-10".

10: Adds 10% for programmed time.  
-10: Remove 10% for programmed time.

1. Press AUTO COOK button

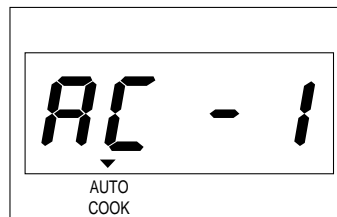

The AUTO COOK indicator light will light "AC-1" will show in the display.

2. Select the desired cooking.

**For example:** SOUP

Press AUTO COOK button twice.

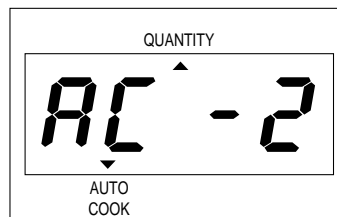

"AC-2" will show in the display. The quantity indicator light will start blinking.

3. If you want to select other menu, press AUTO COOK button until display your desired cooking menu.

4. Turn the DIAL KNOB for desired cooking quantity.

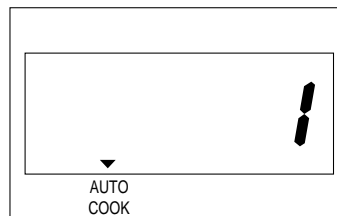

5. Select the desired cooking quantity.

**For example:** 3(350g)

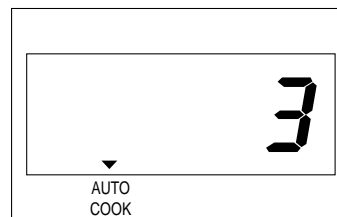

"3" will show in the display.

6. If you want to select other, press quantity button once again until display you desired.

7. Press  $\diamond$  button.  
This example don't set MORE or LESS function.

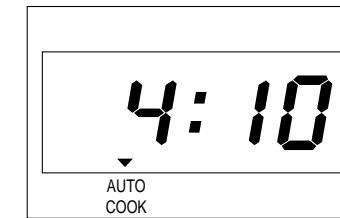

The oven will now start auto cook for menu 2. The indicator light starts blinking.

8. Buzzer will sound at the end of the cooking time. The indicator light will go off. The display panel will return to the time of day. the oven light will turn off and the turntable will stop turning.

**NOTE:** • AUTO COOK menu and quantity.

MENU NO		QUANTITY NO	
1	BEVERAGE	1	1 CUP
		2	2 CUPS
		3	3 CUPS
2	SOUP	1	250g
		2	300g
		3	350g
		4	400g
3	CASSEROLE	1	200g
		2	400g
		3	600g
		4	800g
4	VEGETABLE	1	250g
		2	300g
		3	350g
		4	400g
5	FISH FILLET	1	300g
		2	400g
		3	500g
		4	600g
		5	700g



## SPEEDY COOK

### SETTING THE CONTROL

1. Press  button.  
Then start lamp will start blinking.

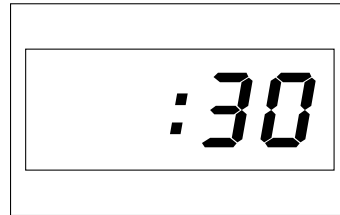

Whenever the button is pressed, cooking time is increased 30 seconds.  
If the time was setting, this oven is operated automatically after 2 seconds to microwave high power.

**NOTE:** This key is increased from 30 seconds to 5 minutes.  
If you are pressing more than about 0.5 seconds, the time is increased 30 seconds continuously.

## CHILD SAFTY LOCK

- The safty lock prevents unwanted oven operation such as by small children.
- To set, press STOP/CLEAR for 3 seconds, lock indicator light starts blinking.
- To cancel, press STOP/CLEAR for 3 seconds, lock indicator goes off.

## +1 min.

- The function can use when oven is working state.
- Whenever press this button, time is increased as 1 minute.
- Time is increased until 60 minutes.



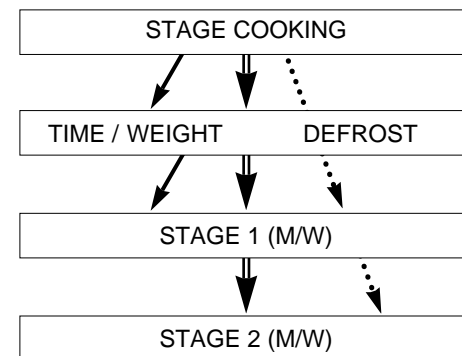

### STAGE COMBINATIONS

This oven has the ability to be programmed to do up to three consecutive functions. These combinations are given below and either the complete program or part of it can be used.





- \* When you set stage mode, indicator is lighted only setting.
- \* When you press START button, all indicators are lighted setted function.  
Indicator of operating function is blinking.

## TO STOP THE OVEN WHILE IT IS OPERATING

1. Press  (STOP/CLEAR) button.  
-Touch  once more to erase all instruction except clock.  
-You can restart the oven by touching  (START) button.
2. Open the door  
-You can restart the oven by closing the door and touching  button.

**NOTE:** Oven stops operating when door is opened.

### ERASING INSTRUCTIONS

- Touch  (STOP/CLEAR) button to erase all instructions you set previously.
- Opening the oven door during cooking dose not erase cooking instruction.
- If you push twice  button during operation, the cooking instruction is all erased.

### GENERAL COOKING HINTS

1. When cook a roast with an excess amount of drippings, it is helpful to remove the drippings at turnover time to prevent spattering.
2. Prick the meats, fish or poultry with a fork to prevent bursting.  
Steam builds up pressure in meats, fish or poultry which are tightly covered by a skin or membrane.
3. Reduce suggested cooking times, it is always better to undercook foods rather than to oven-cook them.  
If a range of times is stated in a recipe, cook the minimum suggested time, check for doneness, and then cook slightly longer if necessary.

## GENERAL GUIDELINES

Since microwave cooking to some extent is different from traditional cooking, the following general guidelines should be considered whenever you use your microwave oven:

### If the food is undercooked

Check if:

- You have selected the correct power level.
- the selected time is sufficient-the times given in the recipes are approximate. They depend on initial temperature, weight and density of the food etc.
- the container is appropriate.

### If the food is overcooked,i.e. dried out or burnt

Before you cook again, consider whether:

- the power level was too high.
- the set time was too long-the times in the recipes are approximate. They depend on initial temperature, weight and density of the food etc.

### Points to remember when defrosting

- The shape of the package alters the defrosting time. Shallow rectangular packets defrost more quickly than a deep block.
- Separate pieces as they begin to defrost; free-flow slices defrost; free-flow slices defrost more easily.
- Shield areas of food with small pieces of foil if they start to become warm.
- When defrosting, it is better to under thaw the food slightly and allow the process to finish during the standing time.

### The amount of food

The more food you want to prepare the longer it takes. A rule of thumb is that double amount of food requires almost double the time. If one potato takes four minutes to cook, approximately seven minutes are required to cook two potatoes.

### Starting temperature of food

The lower the temperature of the food which is being put into the microwave oven, the longer time it takes. Food at room temperature will be reheated more quickly than food at refrigerator temperature.

### Composition of the food

Food with a lot of fat and sugar will be heated faster than food containing a lot of water. fat and sugar will also reach a higher temperature than water in the cooking process.

The more dense the food, the longer it takes to heat. "Very dense" food like meat takes longer time to reheat than lighter, more porous food like sponge cakes.

### Size and shape

Smaller pieces of food will cook more quickly than larger pieces and uniform pieces of food cook more evenly than irregularly shaped foods.

With unevenly shaped food, the thinner parts will cook faster than the thicker areas. Place the thinner chicken wings and legs to the centre of the dish.

### Stirring, turning of foods

Stirring and turning of foods are techniques used in conventional and well as in microwave cooking to distribute the heat quickly to the centre of the dish and avoids over-cooking at the outer edges of the food.

### Covering food helps:

- To reduce spattering
- To shorten cooking times
- To retain food moisture

All covering, which will allow microwaves to pass through are suitable-See above "Which utensils can be used in the oven"

### Releasing pressure in foods

Several foods are tightly covered by a skin or membrane.

These foods should be picked with a fork or cocktail stick to relieve the pressure and to prevent bursting, as steam builds up within them during cooking. This applies to jacket potatoes, potatoes, chicken livers, sausages, egg yolks and some fruits.

### Standing time

Always allow the food to stand for some time after using the oven. standing time after defrosting, cooking/reheating always improves the result since the temperature will then be evenly distributed through out the food.

In a microwave oven foods continue to cook even when the microwave energy is turned off. They are no longer cooking by microwaves, but they are still being cooked by the conduction of the high residual heat to the centre of the food.

The length of standing time depends on the volume and density of the food. Sometimes it can be as short as the time it takes you to remove the food from the oven and take it to the serving table. However, with larger, denser foods, the standing time may be as long as 10minutes. Upon 'standing', the internal temperature of the food will rise by as much as 8°C and the food will finish cooking during this time.

### Arranging food

This is done in several ways in microwave cooking to give more even cooking results.

If you are cooking several items of the same food such as jacket potatoes, place them in a ring pattern for uniform cooking. When cooking foods of uneven shapes or thickness, place the smaller or thinner area of the food towards the centre of the dish where it will be heated last.



Uneven foods such as fish should be arranged in the oven with the tails to the centre.

If you are saving a meal in the refrigerator or 'plating' a meal for reheating, arrange the thicker, denser foods to the outside of the plate and the thinner or less dense foods in the middle.

Place thin slices of meat on top of each other or interlace them.

Thicker slices such as meat loaf and sausages have to be placed close to each other.

Gravy or sauce should be reheated in a separate container.



Choose a tall, narrow container rather than a low and wide container. When reheating gravy, sauce or soup, do not fill the container more than 2/3.



When you cook or reheat whole fish, score the skin this prevents cracking.

Shield the tail and head with small pieces of foil to prevent over-cooking but ensure the foil does not touch the sides of the oven.



## COOKING UTENSILS

Microwave energy is produced by high frequency radio waves. They are reflected from metal, but will pass through most cooking utensils without heating them.

As the waves come into contact with the food, they are converted into heat energy. Listed below are the suggested cooking utensils for this microwave oven and when to use them.

1. Dishes with metal trim of any type - should not be used. This will cause sparking.
2. Glass or ceramic heat proof dishes - excellent for microwave cooking.
3. China dishes and plates - without metal trim may be used to cook and heat individual portions of food.
4. Wood or straw - use only for short period, wood contains some moisture and the microwave energy may cause the wood to dry out and crack.
5. Aluminum foil - may be used in very small pieces for shielding only.  
Any aluminum foil used should never be closer than 2.5cm from side walls of oven.
6. Plastic - most heat resistant plastic dinnerware may be used for heating food. However polyethylene, melamine, phenol are unsuitable for use in the oven. They become hot in the microwave.
7. Wax paper - use as a cover to avoid spatters.
8. Metal - In general, metal utensils should not be used in microwave oven.

## CARE AND CLEANING

Although your oven is provided with safety features, it is important to observe the following:

1. It is important not to defeat or tamper with safety interlocks.
2. Do not place any object between the oven front face and the door or allow residue to accumulate on sealing surfaces. Wipe the sealing area frequently with a mild detergent, rinse and wipe dry. Never use abrasive powders or pads.
3. When opened, the door must not be subjected to strain, for example, a child hanging on an opened door or any load could cause the oven to fall forward to cause injury and also damaged to the door. Do not operate the oven if it is damaged, until it has been repaired by a trained service technician.  
It is particularly important that the oven closes properly and that there is no damage to the:  
i) Door (bent)  
ii) Hinges and Hooks (broken or loosened)  
iii) Door seals and sealing surfaces.
4. The oven should not be adjusted or repaired by anyone except a properly trained service technician.

## BEFORE CALLING FOR SERVICE

You can often correct operating problems yourself. If your microwave oven fails to work properly, locate the operating problem in the chart below and try the solutions marked for each problems.

If the microwave oven still does not work properly, contact the nearest Service Center.

**Note:**

It is quite normal for steam to be emitted around the door during the cooking cycle. The door is not intended to seal the oven cavity completely but its special design contributes to the completion of the appliance.

**Caution:**

1. Do not attempt to operate the oven while empty as this will cause damage.
2. As an exhaust is located in the rear of the oven, install the oven so as not to block the outlet.

PROBLEM	1	2	3	4	5	6	7	8	9	10	11	12
Oven will not start	X	X	X	X								
Arcing or sparking					X	X						
Unevenly cooked foods					X		X	X	X			
Overcooked foods										X		
Undercooked foods					X				X	X	X	
Improper defrosting					X		X	X		X		X

SOLUTION	1	2	3	4	5	6	7	8	9	10	11	12
Is start button pressed?												
Is power cord plugged in?												
Is door closed?												
Set the cooking time.												
Use approved cookware only.												
Do not operate oven empty.												
Supplied tray must be used.												
Turn of stir food.												
Completely defrost food.												
Turn correct dial knob/Press correct Function button.												
Check to see that oven ventilation ports are not restricted.												
Open the door slightly and wait 10~15min. for cooling.												

## QUESTIONS AND ANSWERS

**Q: I accidentally ran my microwave oven without any food in it. Is it damaged?**

A: We do not recommend to operating the microwave oven without any food. However, running the oven empty for a SHORT time will not damage the oven.

**Q: Can I open the door when the oven is operating?**

A: The door can be opened anytime during the oven operation. Microwave energy will be instantly switched off and the time setting will maintain until the door is closed.

**Q: Does microwave energy pass through the viewing screen in the door?**

A: No. The metal screen bounces back the energy to the oven cavity. The holes are made to allow light to pass through. They do not let microwave energy pass through.

**Q: My microwave oven causes interference with my TV. Is this normal?**

A: Some radio and TV interference might occur when you cook with the microwave oven. This interference is similar to the interference caused by small appliances such as mixers, vacuums, blow dryers, etc. It does not indicate a problem with your oven.

**Q: How can we know whether the oven is operating or not?**

A: Oven is operating only when the door is closed. The operation of fan motor is same as the oven's operating cycle.

**Q: The oven only operates when the door is closed.**

A: The operation of the fan motor is at the same time as the oven is operating.

**Q: Why does my oven light dim?**

A: When cooking with DEF. power, the oven must cycle to obtain the selected power levels. The oven light dims and clicking noises can be heard when the oven cycles.

**Q: When is the oven light on and off?**

A: The oven light is on during the cooking time.

**Q: Why does steam accumulate on the oven door?**

A: The heat given off from the cooking food warms the air in the oven cavity. This warmed air is carried out of the oven by the air flow pattern in the oven. There are no microwave in the air. The oven vents should never be blocked during cooking.

**Q: Why does the smoke come out of the exhaust vent at the back of oven?**

A: It is normal for smoke to come out of the vents during cooking. Smoke may be produced when food is overcooked.