

Mini Hi-Fi Component System

Operating Instructions

Owner's Record

The model and serial numbers are located on the rear of the unit. Record the serial number in the space provided below. Refer to them whenever you call upon your Sony dealer regarding this product.

Model No. _____

Serial No. _____



**MHC-GX45/GX35/GX25
MHC-RG440S/RG330/RG310/
RG220**

WARNING

To prevent fire or shock hazard, do not expose the unit to rain or moisture.

To prevent fire, do not cover the ventilation of the apparatus with news papers, table-cloths, curtains, etc. And don't place lighted candles on the apparatus.

To prevent fire or shock hazard, do not place objects filled with liquids, such as vases, on the apparatus.

Do not install the appliance in a confined space, such as a bookcase or built-in cabinet.

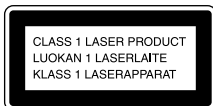

This appliance is classified as a CLASS 1 LASER product. This label is located on the rear exterior.



Don't throw away the battery with general house waste, dispose of it correctly as chemical waste.

NOTICE FOR THE CUSTOMERS IN THE U.S.A.

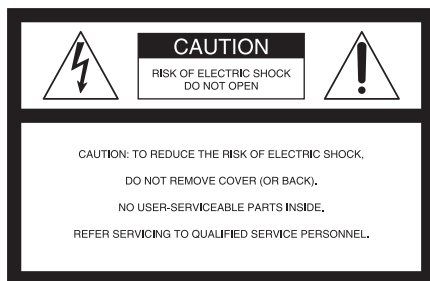

This symbol is intended to alert the user to the presence of uninsulated "dangerous voltage" within the product's enclosure that may be of sufficient magnitude to constitute a risk of electric shock to persons.



This symbol is intended to alert the user to the presence of important operating and maintenance (servicing) instructions in the literature accompanying the appliance.



CAUTION

The use of optical instruments with this product will increase eye hazard.

WARNING

This equipment has been tested and found to comply with the limits for a Class B digital device, pursuant to Part 15 of the FCC Rules. These limits are designed to provide reasonable protection against harmful interference in a residential installation. This equipment generates, uses, and can radiate radio frequency energy and, if not installed and used in accordance with the instructions, may cause harmful interference to radio communications. However, there is no guarantee that interference will not occur in a particular installation. If this equipment does cause harmful interference to radio or television reception, which can be determined by turning the equipment off and on, the user is encouraged to try to correct the interference by one or more of the following measures:

- Reorient or relocate the receiving antenna.
- Increase the separation between the equipment and receiver.
- Connect the equipment into an outlet on a circuit different from that to which the receiver is connected.
- Consult the dealer or an experienced radio/TV technician for help.

CAUTION

You are cautioned that any changes or modifications not expressly approved in this manual could void your authority to operate this equipment.

Note to CATV system installer:

This reminder is provided to call the CATV system installer's attention to Article 820-40 of the NEC that provides guidelines for proper grounding and, in particular, specifies that the cable ground shall be connected to the grounding system of the building, as close to the point of cable entry as practical.

NOTICE FOR THE CUSTOMERS IN CANADA

CAUTION

TO PREVENT ELECTRIC SHOCK, DO NOT USE THIS POLARIZED AC PLUG WITH AN EXTENSION CORD, RECEPTACLE OR OTHER OUTLET UNLESS THE BLADES CAN BE FULLY INSERTED TO PREVENT BLADE EXPOSURE.

Except for European model



ENERGY STAR® is a U.S. registered mark. As an ENERGY STAR® partner, Sony Corporation has determined that this product meets the ENERGY STAR® guidelines for energy efficiency.

Table of Contents

How to use this manual.....	4
Playable discs.....	4
<hr/>	
Getting Started	
Hooking up the system.....	6
Setting the clock.....	8
<hr/>	
CD/MP3 – Play	
Loading a disc.....	9
Playing a disc.....	9
— Normal Play/Shuffle Play	
Playing repeatedly.....	11
— Repeat Play	
Creating your own program.....	12
— Program Play	
<hr/>	
Tuner	
Presetting radio stations.....	13
Listening to the radio.....	14
— Preset Tuning	
— Manual Tuning	
Using the Radio Data System (RDS)....	15
(European model only)	
<hr/>	
Tape – Play	
Loading a tape.....	16
Playing a tape.....	16
<hr/>	
Tape – Recording	
Recording your favorite CD tracks on a tape.....	17
— CD-TAPE Synchro Recording	
Recording on a tape manually.....	17
— Manual Recording	

Sound Adjustment

Adjusting the sound.....	18
Using the sub woofer.....	18
(MHC-GX45 and MHC-RG440S only)	
Selecting the sound effect.....	18
Selecting the surround effect.....	19
Enhancing video game sound.....	19
— Game Sync	
Mixing video game sound with other sound source.....	19
— Game Mixing	

Timer

Falling asleep to music.....	20
— Sleep Timer	
Waking up to music.....	20
— Daily Timer	
Timer recording radio programs.....	21

Display

Turning off the display.....	22
— Power Saving Mode	
Viewing information about the disc in the display.....	23
Changing the Power illuminator.....	24
— (MHC-GX45/GX35/RG440S/ RG330/RG310 and MHC-RG220 (European and Russian models) only)	

Optional Components

Hooking up optional components.....	25
-------------------------------------	----

Troubleshooting



Problems and remedies.....	26
Messages.....	28

Additional Information

Precautions.....	29
Specifications.....	30
List of button locations and reference pages.....	35

How to use this manual

- This manual mainly explains operations using the remote, but the same operations can also be performed using the buttons on the unit having the same or similar names.
- The following symbols are used in this manual.







Symbol	Meaning
	Functions that can be used with audio CDs
	Functions that can be used with MP3

- MHC-GX45/GX35/RG440S/RG330/RG310 and MHC-RG220 (European and Russian models) are the models used for illustration purposes.

Playable discs

You can play back the following discs on this system. Other discs cannot be played back.

List of playable discs

Format of discs	Disc logo	Contents
Audio CDs		Audio
CD-R/CD-RW (audio data)	 	Audio
CD-R/CD-RW (MP3 files*)	   	Audio

* MHC-GX45/GX35/RG440S/RG330/RG310 and MHC-RG220 (European and Russian models) only

Discs that this system cannot play

- CD-ROMs
- CD-Rs/CD-RWs other than those recorded in the following formats:
 - music CD format
 - MP3 format that conforms to ISO9660*¹ Level 1/Level 2, Joliet*², Romeo*² or Multi Session*³
- A disc that has a non-standard shape (e.g., card, heart).
- A disc with paper or stickers on it.
- A disc that has the adhesive, cellophane tape, or a sticker still left on it.

*¹ A logical format of files and folders on CD-ROMs, defined by ISO (International Standard Organization)

*² Up to 31 characters can be displayed.

*³ Multi Session

This is a recording method that enables adding of data using the Track-At-Once method.

Conventional CDs begin at a CD control area called the Lead-in and end at an area called Lead-out. A Multi Session CD is a CD having multiple sessions, with each segment from Lead-in to Lead-out regarded as a single session.

CD-Extra: This format records audio (audio CD data) on the tracks in session 1 and data on the tracks in session 2.

Mixed CD: This format records data on the first track and audio (audio CD data) on the second and subsequent tracks of a session.

Notes on CD-R and CD-RW

- This system can play CD-R/CD-RW discs edited by the user. However, note that playback of some discs may not be possible depending on the recording device used for recording or the disc condition.
- Discs recorded on CD-R/CD-RW drives may not be played back because of scratches, dirt, recording condition or the driver's characteristics.
- CD-R and CD-RW discs that have not been finalized (processing to allow play by a normal CD player) cannot be played.
- CD-R and CD-RW discs recorded in multi-session that have not ended by "closing the session" are not supported.
- The system may be unable to play MP3 format files that do not have the extender ".MP3".
- Attempting to play non-MP3 format files that have the extender ".MP3" may result in noise or malfunction.
- With formats other than ISO 9660 level 1 and 2, folder names or file names may not be displayed correctly.
- The following discs take a longer time to start playback.
 - a disc recorded with complicated tree structure.
 - a disc recorded in Multi Session.
 - a disc to which data can be added (non-finalized disc).

Music discs encoded with copyright protection technologies

This product is designed to playback discs that conform to the Compact Disc (CD) standard. Recently, various music discs encoded with copyright protection technologies are marketed by some record companies. Please be aware that among those discs, there are some that do not conform to the CD standard and may not be playable by this product.

Cautions when playing a disc that is recorded in Multi Session

- If the disc begins with a CD-DA session, it is recognized as a CD-DA (audio) disc, and playback continues until an MP3 session is encountered.
- If the disc begins with an MP3 session, it is recognized as an MP3 disc, and playback continues until a CD-DA (audio) session is encountered.
- The playback range of an MP3 disc is determined by the tree structure of files produced by analyzing of the disc.
- A disc with a mixed CD format will be recognized as a CD-DA (audio) disc.

Getting Started

Hooking up the system

Perform the following procedures **1** to **5** to hook up your system using the supplied cords and accessories.

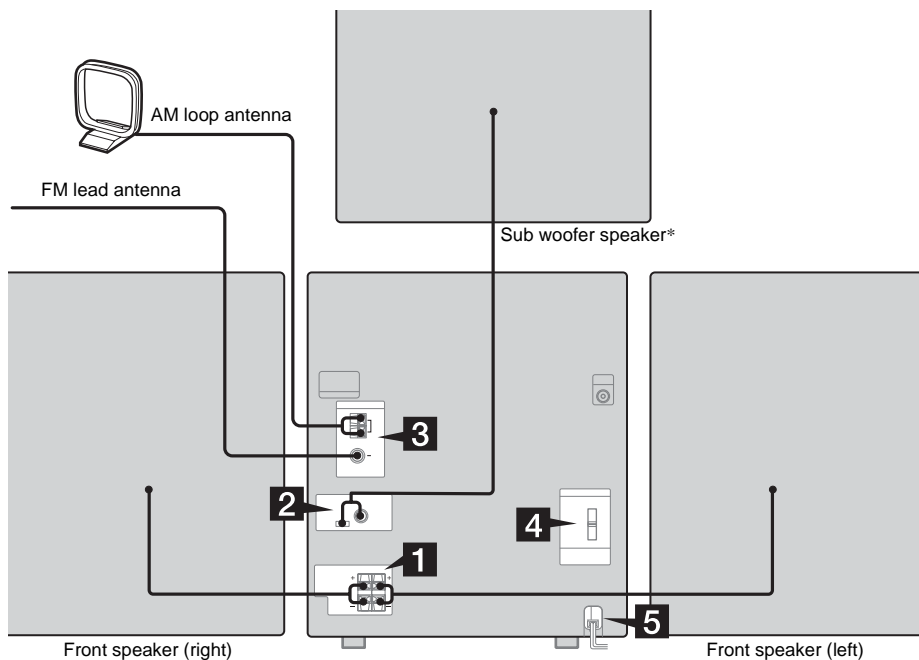

* MHC-GX45 and MHC-RG440S only

1 Connect the speakers.

Connect the right and left speaker cords to the SPEAKER terminals as shown below.

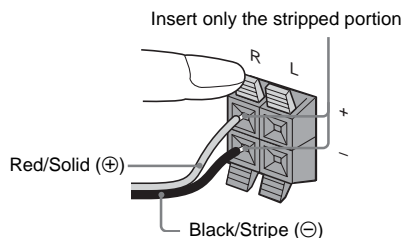

2 Connect the sub woofer speaker. (MHC-GX45 and MHC-RG440S only)

Connect the speaker cords to the SUB WOOFER OUT jack and SUB WOOFER CONTROL jack as shown below.

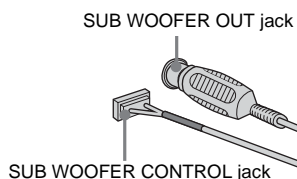

3 Connect the FM and AM antennas.

Set up the AM loop antenna, then connect it.

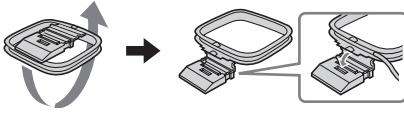

AM loop antenna

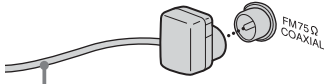

Extend the FM lead antenna horizontally

Note

Keep the antennas away from the speaker cords.

4 For models with a voltage selector, set VOLTAGE SELECTOR to the local power line voltage.

Refer to the print on your system's VOLTAGE SELECTOR for available settings.

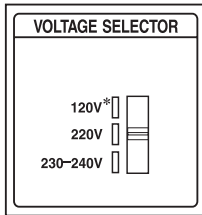

* Saudi Arabian model: 120 – 127 V

5 Connect the power cord to a wall outlet.

The demonstration appears in the display. When you press I/⏻, the system turns on and the demonstration automatically ends. If the plug does not fit the wall socket, detach the supplied plug adaptor (only for models equipped with an adaptor).

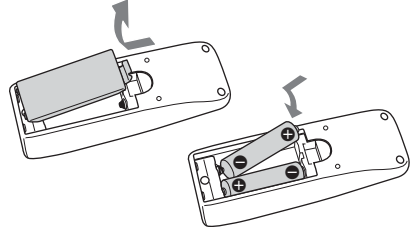
Inserting two R6 (size AA) batteries into the remote**Note**

If you do not use the remote for a long period of time, remove the batteries to avoid possible damage from battery leakage and corrosion.

Tip

With normal use, the batteries should last for about six months. When the remote no longer operates the system, replace both batteries with new ones.

Attaching the speaker pads

Attach the supplied front speaker pads to the bottom of the speakers to stabilize the speakers and prevent them from slipping.

Front speaker (Left (4)/Right (4)) for MHC-GX45/GX25/RG440S/RG310 and MHC-RG220

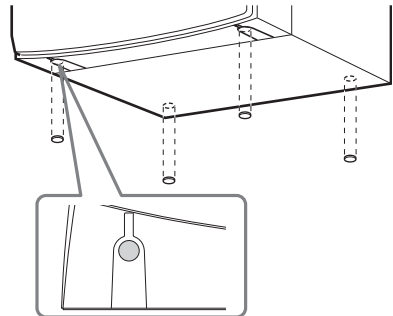

continued

Front speaker (Left (4)/Right (4)) for MHC-GX35 and MHC-RG330
Sub woofer (4) for MHC-GX45 and MHC-RG440S

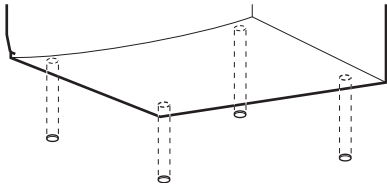

When carrying this system

Perform the following procedure to protect the CD mechanism.

- 1 Make sure that all discs are removed from the system.
- 2 Press I/⏻ to turn off the system.
- 3 Unplug the power cord.

Placing the Sub woofer (MHC-GX45 and MHC-RG440S only)

Since the human ear cannot detect the direction and position where the bass sound being reproduced by a subwoofer (below 150 Hz) comes from, you can place the subwoofer wherever you like in your room. To obtain a better bass reproduction, we recommend you to place the subwoofer on a solid floor where resonance is unlikely to occur.

Notes

- Always place the subwoofer vertically, keeping it a few centimeters away from the wall.
- If the subwoofer is placed in the center of a room, the bass could be extremely weakened. This is due to the influence of the standing wave of the room. If this happens, move the subwoofer away from the center of the room or eliminate the cause of the standing wave, by placing a bookshelf against the wall, etc.

Setting the clock

- 1 Press I/⏻ to turn on the system.
- 2 Press CLOCK/TIMER SET.
- 3 Press ◀◀ or ▶▶ repeatedly to set the hour.
- 4 Press ENTER.
- 5 Press ◀◀ or ▶▶ repeatedly to set the minute.
- 6 Press ENTER.

The clock starts working.

To adjust the clock

- 1 Press CLOCK/TIMER SET.
- 2 Press ◀◀ or ▶▶ to select "CLOCK SET", then press ENTER.
- 3 Do the same procedures as step 3 to 6 above.

Note

The clock settings are canceled when you disconnect the power cord or if a power failure occurs.

Loading a disc

- 1 Press **▲** on the unit.
- 2 Place a disc with the label side up on the disc tray.

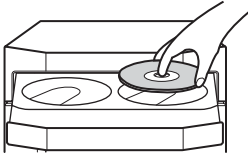

To insert additional discs, press DISC SKIP/EX-CHANGE on the unit to rotate the disc tray.

- 3 Press **▲** on the unit again to close the disc tray.

Notes

- Do not use a disc with tape, seals or paste on it as this may cause malfunction.
- Do not forcibly press the disc tray closed with your finger, as this may cause malfunction.

Playing a disc

— Normal Play/Shuffle Play



This system lets you play audio CDs and discs with MP3 audio tracks.

MP3 audio tracks cannot be played on MHC-GX25 and MHC-RG220 (except for European and Russian models).

Example: When a disc is loaded

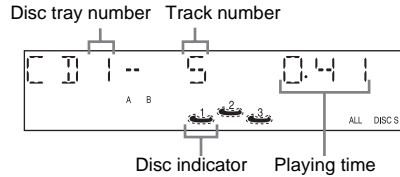

- 1 Press CD.

2 Press **PLAY MODE** in stop mode repeatedly until the mode you want appears in the display.

Select	To play
ALL DISCS (Normal Play)	All discs in the disc tray continuously.
1DISC (Normal Play)	The tracks on the disc you have selected in original order.
ALBM* (Normal Play)	All MP3 audio tracks in the album on the disc you have selected in original order. When playing a non-MP3 disc, Album Play becomes 1 DISC Play.
ALL DISCS SHUF (Shuffle Play)	The tracks on all discs in random order.
1DISC SHUF (Shuffle Play)	The tracks on the disc you have selected in random order.
ALBM SHUF* (Shuffle Play)	The MP3 audio tracks in the album on the disc you have selected in random order. When playing a non-MP3 disc, Album Shuffle Play becomes 1 DISC SHUF Play.
PGM (Program Play)	The tracks on the disc in the order you want them to be played (see “Creating your own program” on page 12).

* MHC-GX45/GX35/RG440S/RG330/RG310 and MHC-RG220 (European and Russian models) only

3 Press **▶**.

Other operations

To	Do this
Stop play	Press ■ .
Pause	Press ⏸ . Press again to resume play.
Select a track	Press ◀◀ or ▶▶ repeatedly.
Select an album of MP3* ¹	Press ALBUM - or + repeatedly after step 2.
Find a point in a track* ²	Keep pressing ◀◀ or ▶▶ during playback and release it at the desired point.
Select a disc in stop mode	Press D , SKIP (or DISC 1 - 3 * ³ or DISC SKIP/EX-CHANGE on the unit).
Switch to CD function from another source	Press DISC 1 - 3 on the unit (Automatic Source Selection).
Exchange other discs while playing	Press DISC SKIP/EX-CHANGE on the unit.
Remove a disc	Press ▲ on the unit.

*¹ You may not be able to search between multiple files. Also, the time may not be displayed correctly for some files.

*² except for MP3 audio tracks

*³ **DISC 1 - 3** on the unit are not available when “**ALL DISCS SHUF**” is selected.

Notes

- You cannot change the play mode during playback.
- Some time may be needed to start playback of discs recorded in complex configurations such as many layers.
- When the disc is inserted, the player reads all the tracks on that disc. If there are many albums or non-MP3 audio tracks on the disc, it may take a long time for play to begin or for the next MP3 audio track to start play.
- Do not save unnecessary albums or tracks other than MP3 ones in the disc to be used for MP3 listening. We recommend that you do not save other types of tracks or unnecessary albums on a disc that has MP3 audio tracks.
- An album that does not include an MP3 audio track is skipped.
- Maximum album number: 150 (including root folder)
- The maximum number of MP3 audio tracks and albums that can be contained on a single disc is 300.
- Playback is possible up to 8 levels.
- MP3 audio tracks are played back in the order that they are recorded on the disc.
- Depending on the encoding/writing software, recording device, or the recording media used at the time an MP3 audio track is recorded, you may encounter such problems as disabled playback, sound interruptions, and noise.

Playing repeatedly

— Repeat Play



You can play all the tracks or a single track on a disc.

MP3 audio tracks cannot be played on MHC-GX25 and MHC-RG220 (except for European and Russian models).

Using the display window

Press REPEAT until “REP” or “REP1” appears.

REP: For all the tracks on the disc up to five times.

REP1: For a single track only.

To cancel Repeat Play

Press REPEAT repeatedly until both “REP” and “REP1” disappear.

Notes

- You cannot select “REP” and “ALL DISCS SHUF” at the same time.
- When you select “REP1”, that track is repeated endlessly until “REP1” is canceled.

Creating your own program

— Program Play



You can make a program of up to 25 steps from all the discs in the order you want to play them. You can synchro record the programmed tracks onto a cassette tape (page 17).

MP3 audio tracks cannot be played on MHC-GX25 and MHC-RG220 (except for European and Russian models).

Using the display window

- 1 Press **CD**.
- 2 Press **PLAY MODE** in stop mode repeatedly until “**PGM**” appears.
- 3 Press **D.SKIP** (or **DISC 1 – 3** or **DISC SKIP/EX-CHANGE** on the unit) to select a disc.

To program all the tracks on a disc at once, proceed to step 5 with “**AL**” displayed.

- 4 Press **◀◀** or **▶▶** repeatedly until the desired track number appears.

When programming an MP3, press **ALBUM –** or **+** to select album, then press **◀◀** or **▶▶** repeatedly until the desired track number appears.

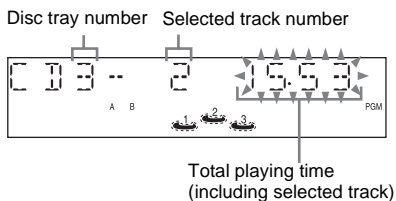

- 5 Press **ENTER**.

The track is programmed.

The program step number appears, followed by the total playing time.

6 Program additional discs or tracks.

To program	Repeat steps
Other discs	3 and 5
Other tracks on the same disc	4 and 5
Other tracks on other discs	3 to 5

7 Press ▶.

Program Play starts.

Other operations

To	Do this
Cancel Program Play	Press PLAY MODE in stop mode repeatedly until “ PGM ” disappears.
Clear a track from the end	Press CLEAR in stop mode.

Tips

- The program you made remains after Program Play finishes. To play the same program again, press **CD**, then press **▶**. However, the program is cleared when you open the disc tray.
- “-- --” appears when the total CD program time exceeds 100 minutes, or when you select a CD track whose number is 21 or over, or when you select an MP3 audio track.

Presetting radio stations

You can preset up to 20 FM stations and 10 AM stations. You can then tune in any of those stations simply by selecting the corresponding preset number.

Automatic tuning preset

You can automatically tune in all of the stations that can be received in your area and then store the radio frequency of the desired stations.

- 1 Press **TUNER/BAND** repeatedly to select **"FM"** or **"AM"**.
- 2 Press and hold **TUNING -/+** (or **←←** or **→→**) on the unit) until the frequency indication starts to change, then release it.

The frequency changes as the system scans for a station. Scanning stops automatically when a station is tuned in. At that time, "TUNED" and "STEREO" (for an FM stereo program) appear.



If **"TUNED"** does not appear and the scanning does not stop

Set the frequency of the desired radio station as described in steps 2 and 6 of "Manual tuning preset" (page 13).

- 3 Press **TUNER MEMORY**.

A preset number appears.

Preset number



- 4 Press **PRESET -/+** (or **←←** or **→→**) on the unit) repeatedly to select the desired preset number.
- 5 Press **ENTER**.
- 6 Repeat steps 1 through 5 to store other stations.

Manual tuning preset

You can manually tune in and store the radio frequency of the desired stations.

- 1 Press **TUNER/BAND** repeatedly to select **"FM"** or **"AM"**.
- 2 Press **TUNING -/+** (or **←←** or **→→**) on the unit) repeatedly to tune in the desired station.
- 3 Press **TUNER MEMORY**.
A preset number appears.
- 4 Press **PRESET -/+** (or **←←** or **→→**) on the unit) repeatedly to select the desired preset number.
- 5 Press **ENTER**.
- 6 Repeat steps 1 through 5 to store other stations.

Other Operations

To	Do this
Tune in a station with a weak signal	Follow the procedure described in “Manual tuning preset” (page 13).
Set another station to the existing preset number	Start over from step 1. After step 3, press PRESET $-/+$ (or \lll or \ggg on the unit) repeatedly to select the preset number you want to store the other station.

To change the AM tuning interval (except for European, Russian, Middle Eastern and Philippine models)

The AM tuning interval is factory-preset to 9 kHz (or 10 kHz for some areas). To change the AM tuning interval, tune in any AM station first, then turn off the system. While holding TUNER/BAND on the unit, press I/OFF on the unit. When you change the interval, all the AM preset stations are erased. To reset the interval, repeat the same procedure.

Note

You cannot change the AM tuning interval in the Power Saving Mode.

Tips

- The preset stations are retained for about a day even if you disconnect the power cord or if a power failure occurs.
- To improve the reception, adjust the supplied antennas or connect an external antenna.

Listening to the radio

You can listen to a radio station either by selecting a preset station, or by manually tuning in the station.

Listening to a preset station

— Preset Tuning

Preset radio stations in the tuner’s memory first (see “Presetting radio stations” on page 13).

- 1 Press TUNER/BAND repeatedly to select “FM” or “AM”.**
- 2 Press PRESET $-/+$ (or \lll or \ggg on the unit) repeatedly to select the desired preset station.**

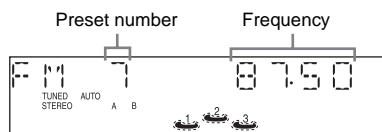

Listening to non-preset radio station

— Manual Tuning

- 1 Press **TUNER/BAND** repeatedly to select “FM” or “AM”.
- 2 Press **TUNING -/+** (or **-◀◀** or **▶▶+** on the unit) repeatedly to tune in the desired station.

Tips

- To improve broadcast reception, adjust the supplied antennas, or connect a commercially available external antenna.
- When an FM stereo program has static noise, press **FM MODE** or **STEREO/MONO*** repeatedly until “MONO” appears. There will be no stereo effect, but the reception will improve.
- Press and hold **TUNING -/+** (or **-◀◀** or **▶▶+** on the unit). The frequency indication changes and scanning stops when the system tunes in a station (Automatic Tuning).
- To record the radio programs, use manual recording (page 17).

* for MHC-GX25 and MHC-RG220 (except for European and Russian models)

Using the Radio Data System (RDS)

(European model only)

What is the Radio Data System?

Radio Data System (RDS) is a broadcasting service that allows radio stations to send additional information along with the regular program signal. RDS is available only on FM stations.*

Note

RDS may not work properly if the station you are tuned in is not transmitting the RDS signal properly or if the signal is weak.

* Not all FM stations provide RDS service, nor do they provide the same types of services. If you are not familiar with the RDS system, check with your local radio stations for details on RDS services in your area.

Receiving RDS broadcasts

Simply select a station from the FM band.

When you tune in a station that provides RDS services, the station name appears in the display.

To check the RDS information

Each time you press **DISPLAY**, the display changes cyclically as follows:

Station name* → Frequency → Program type*
→ Clock display → Effect status

* If the RDS broadcast is not properly received, the station name may not appear in the display.

Loading a tape

- 1 Press **TAPE A/B** repeatedly to select deck A or B.
- 2 Press **PUSH**  on the unit.
- 3 Load a recorded/recordable tape in deck A or B with the side you want to play/record facing forward.

With the side you want to play/record facing forward.

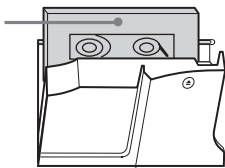

Playing a tape





You can use TYPE I (normal) tape.

- 1 **Load a tape.**
To play both decks in succession, press **PLAY MODE** repeatedly until “RELAY” (Relay Play)* appears in the display.
 - 2 **Press** .
- The tape starts playing.



* After the playback of the front side of deck A, deck B plays the front side, then stops.

Other operations

To	Do this
Stop play	Press  .
Pause	Press  . Press again to resume play.
Fast-forward or rewind	Press  or  .
Remove a tape	Press PUSH  on the unit.

Searching for the beginning of the current or the next track (AMS)*

To go forward

Press  during playback.
“TAPE A (or TAPE B) >>> +1” appears.

To go back

Press  during playback.
“TAPE A (or TAPE B) <<< -1” appears.

* AMS (Automatic Music Sensor)

Note

The AMS function may not operate correctly under the following circumstances:

- When the unrecorded space between songs is less than 4 seconds long.
- When the system is placed near a television.

Recording your favorite CD tracks on a tape

— CD-TAPE Synchro Recording

You can record a whole CD on a tape. You can use TYPE I (normal) tape. The recording level is adjusted automatically.

- 1 Load a recordable tape into deck B.**
- 2 Press CD and load a disc you want to record.**
- 3 Press CD SYNC on the unit.**
Deck B stands by for recording.
“REC” flashes.
- 4 Press REC PAUSE/START on the unit.**
Recording starts.

To stop recording

Press ■.

To record a disc by specifying track order

You can record only your favorite CD tracks using Program Play. Between steps 2 and 3, perform steps 2 to 6 of “Creating your own program” (page 12).

Recording on a tape manually

— Manual Recording

You can record just the portions you like from a CD, tape or radio program on a tape. You can also record from connected components (see “Hooking up optional components” on page 25).

- 1 Load a recordable tape into deck B.**
- 2 Press CD, TAPE A/B, TUNER/BAND or GAME (MD) (or GAME*) to select the desired source to record.**
 - CD: To record from this system’s CD player.
 - Tape: To record from this system’s tape deck A.
 - Tuner: To record from this system’s tuner.
 - Game: To record from the connected video game machine to GAME INPUT AUDIO L/R jacks.
* for MHC-GX25 and MHC-RG220 (except for European and Russian models)
- 3 Press REC PAUSE/START on the unit.**
Deck B stands by for recording.
“REC” flashes.
- 4 Press REC PAUSE/START on the unit, then start playing the desired source to record.**
Recording starts.

To stop recording

Press ■.

Note

You cannot listen to other sources while recording.

Tip

For recording from the radio:

If noise is heard while recording from the radio, move the respective antenna to reduce the noise.

Sound Adjustment

Adjusting the sound

You can reinforce the bass and create a more powerful sound.

Press GROOVE.

Each time you press the button, the display changes cyclically as follows:

GROOVE ON* → V-GROOVE ON* → GROOVE OFF

* The volume switches to power mode, the equalizer curve changes, and the “GROOVE” or “V GROOVE” lights up.

Using the sub woofer

(MHC-GX45 and MHC-RG440S only)

You can use the sound of the sub woofer to suit the sound source.

Press SUB WOOFER ON/OFF on the sub woofer.

The indicator lights up while the sub woofer turns on. Press the button again to turn off the sub woofer.

Tip

You can use VOL +/- (or VOLUME control on the unit) to adjust the volume of the sub woofer linked to the front speakers.

Selecting the sound effect

Selecting the effect from the music menu

Press PRESET EQ or EQ +/-* (or MUSIC EQ, MOVIE EQ or GAME EQ on the unit) repeatedly to select the preset you desire.

The preset name appears in the display. See the chart “Sound effect options”.

* for MHC-GX25 and MHC-RG220 (except for European and Russian models)

To cancel the sound effect

Press EFFECT ON/OFF on the unit or ON/OFF*.

* for MHC-GX25 and MHC-RG220 (except for European and Russian models)

Sound effect options

“SURR” appears if you select an effect with surround effects.

MUSIC EQ

Effect

ROCK	Standard music sources
POP	

MOVIE EQ

Effect

MOVIE	Soundtracks and special listening situations
-------	--

GAME EQ

Effect

GAME	PlayStation 1, 2 and other video game music sources
------	---

Tip

You can also select “GROOVE”, “V GROOVE” or “EFFECT OFF” by pressing PRESET EQ (or EQ +/- for MHC-GX25 and MHC-RG220 (except for European and Russian models)) repeatedly.

Selecting the surround effect

Press **SURROUND**.

“SURR” appears in the display.

Press the button again to cancel SURROUND.

Enhancing video game sound

— *Game Sync*

You need to connect a video game machine (see “Hooking up optional components” on page 25).

Press **GAME (MD) or GAME***.

* for MHC-GX25 and MHC-RG220 (except for European and Russian models)

Tips

- In the standby mode, the system automatically turns on.
- The GAME EQ is automatically selected.
- These operations cannot be performed in the Power Saving Mode.

Mixing video game sound with other sound source

— *Game Mixing*

- 1 **Select the desired source sound.**
- 2 **Press GAME MIXING on the unit.**

Each time you press the button, the level of the game sound changes cyclically as follows:

MIXING LOW → MIXING MID →
MIXING HIGH → MIXING OFF

Note

If you start recording while Game Mixing is activated, Game Mixing is canceled. To record the mixed sound, press GAME MIXING on the unit after step 3 of “Recording on a tape manually” on page 17, and then press REC PAUSE/START on the unit to start the recording.

Tips

- The GAME MIXING indicator lights up while Game Mixing is activated.
- Once Game Mixing is activated, it will remain active while the power is on even if the source sound is changed.

Falling asleep to music

— Sleep Timer

You can set the system to turn off after a certain time, so that you can fall asleep to music.

Press SLEEP.

Each time you press the button, the minute display (the turn-off time) changes cyclically as follows:

AUTO* → 90MIN → 80MIN → 70MIN
→ ... → 10MIN → OFF

* The system automatically turns off in 100 minutes or after the current disc or tape finishes playing.

Other operations

To	Press
Check the remaining time**	SLEEP once.
Change the time to turn off	SLEEP repeatedly to select the time you want.
Cancel the Sleep Timer Function	SLEEP repeatedly until "SLEEP OFF" appears.

** You cannot check the remaining time if you select "AUTO".

Waking up to music

— Daily Timer

You can wake up to music at a preset time. Make sure you have set the clock (see "Setting the clock" on page 8).

1 Prepare the sound source you want to play.

- CD: Load a disc. To start from a specific track, make a program (see "Creating your own program" on page 12).
- Tape: Load a tape.
- Tuner: Tune in the preset radio station (see "Listening to the radio" on page 14).

2 Press VOL +/- (or turn VOLUME control on the unit) to adjust the volume.

3 Press CLOCK/TIMER SET until "DAILY SET" appears.

4 Press ENTER.

"ON" appears and the hour indication flashes.

5 Set the time to start playing.

Press ◀◀ or ▶▶ repeatedly to set the hour, then press ENTER.

The minute indication flashes.

Press ◀◀ or ▶▶ repeatedly to set the minute, then press ENTER.

6 Set the time to stop playing following the same procedure as step 5.

7 Press ◀◀ or ▶▶ repeatedly until the desired sound source appears.

Each time you press the button, the display changes cyclically as follows:



8 Press ENTER.

The type of timer ("DAILY"), the start time, the stop time, and the sound source appear in turn, before the original display returns.

9 Press I/⏻ to turn off the system.

Other operations

To	Do this
Check the setting	<ol style="list-style-type: none">1 Press CLOCK/TIMER SELECT.2 Press ◀◀ or ▶▶ repeatedly until “DAILY” appears, then press ENTER.
Change the setting	Start over from step 1.
Cancel the timer	<ol style="list-style-type: none">1 Press CLOCK/TIMER SELECT.2 Press ◀◀ or ▶▶ repeatedly until “TIMER OFF” appears, then press ENTER.

Notes

- You cannot activate the Daily Timer and recording timer at the same time.
- If you use the Daily Timer and the Sleep Timer at the same time, the Sleep Timer has priority.
- If the system is on at the preset time, the Daily Timer will not be activated.

Tip

The system turns on 15 seconds before the preset time.

Timer recording radio programs

You can record a preset radio station from a specified time.

To timer record, you must first preset the radio station (see “Presetting radio stations” on page 13) and set the clock (see “Setting the clock” on page 8).

- 1 **Tune in the preset radio station (see “Listening to a preset station” on page 14).**
- 2 **Press CLOCK/TIMER SET.**
“DAILY SET” appears.
- 3 **Press ◀◀ or ▶▶ repeatedly to select “REC SET”, then press ENTER.**
“ON” appears and the hour indication flashes.
- 4 **Set the time to start recording.**
Press ◀◀ or ▶▶ repeatedly to set the hour, then press ENTER.
The minute indication flashes.
Press ◀◀ or ▶▶ repeatedly to set the minute, then press ENTER.
- 5 **Set the time to stop recording following the same procedure as step 4.**
The start time, the stop time, and the preset radio station to be recorded (e.g., “TUNER FM 5”) appear in turn, before the original display returns.
- 6 **Load a recordable tape into deck B.**
- 7 **Press I/⏻ to turn off the system.**

Other operations

To	Do this
Check the setting	1 Press CLOCK/TIMER SELECT. 2 Press ◀◀ or ▶▶ repeatedly until “REC SELECT” appears, then press ENTER.
Change the setting	Start over from step 1.
Cancel the timer	1 Press CLOCK/TIMER SELECT. 2 Press ◀◀ or ▶▶ repeatedly until “TIMER OFF” appears, then press ENTER.

Notes

- You cannot activate the Daily Timer and recording timer at the same time.
- If you use the recording timer, the Daily Timer and the Sleep Timer at the same time, the Sleep Timer has priority.
- If the system is on at the preset time, the timer-recording will not be activated.
- The volume is reduced to minimum during recording.

Display

Turning off the display

— Power Saving Mode

The demonstration display (display window and buttons lighting and flashing even when the system power is off) and the clock display can be turned off to minimize the amount of power consumed during standby (Power Saving Mode).

Press DISPLAY repeatedly while the system is off until the demonstration display or the clock display disappears.

To cancel Power Saving Mode

Press DISPLAY while the system is off. Each time you press the button, the display switches cyclically as follows:

Demonstration display → Clock display* → No display (Power Saving Mode)

* The clock is displayed only if you set the clock.

Note

You cannot perform the following operations in Power Saving Mode.

- setting the clock
- changing the AM tuning interval (except for European, Russian, Middle Eastern and Philippine models)
- turning on the system by pressing the function buttons

Tip

The timer continues to operate in Power Saving Mode.

Viewing information about the disc in the display

You can check the playing time and remaining time of the current track or that of the disc.

Checking the remaining time and titles (CD/MP3)

Press DISPLAY during Normal Play.

Each time you press the button, the display changes cyclically as follows:

■ When playing a CD

Elapsed playing time of the current track →
Remaining time of the current track*¹ →
Remaining time of the current disc *² →
Clock display (for eight seconds) →
Effect status

*¹ “_ _ _ _” appears when playing the program containing more than 20 tracks or 100 minutes.

*² “_ _ _ _” appears in ALL DISCS or program play mode.

■ When playing an MP3 (MHC-GX45/GX35/RG440S/RG330/RG310 and MHC-RG220 (European and Russian models) only)

Elapsed playing time of the current track →
Remaining time of the current track*¹ →
Remaining time of the current disc*² →
Track title*³ → Album name → Clock display (for eight seconds) → Effect status

*¹ “_ _ _ _” appears when playing the program containing more than 20 tracks or 100 minutes, or MP3 audio tracks.

*² “_ _ _ _” appears in ALL DISCS or program play mode or when playing back MP3 audio tracks.

*³ When you play back a track with an ID3 tag ver. 1 (ver. 1.0 or 1.1), the ID3 tag appears. The ID3 tag displays only the track title information.

Checking the total playing time and titles (CD)

Press DISPLAY in stop mode.

Each time you press the button, the display changes cyclically as follows:

■ When a CD is in Normal Play mode

TOC display*¹ or total album number of the disc*² or total number of the current album*² →
Album name*² → Clock display (for eight seconds) → Effect status

*¹ TOC = Table of Contents; displays current disc number, total number of tracks on the disc, and total playing time of the disc.

*² For discs with MP3 audio tracks, album titles may not be displayed depending on the play mode.

Notes

- The total playing time is not displayed for a disc with MP3 audio tracks.
- ID3 tag applies only to version 1.
- If the MP3 file you play back has an ID3 tag, the ID3 tag information is displayed as a track title.
- In the following case, elapsed playing time and remaining time of the track may not be displayed accurately.
 - when an MP3 file of VBR (variable bit rate) is played.
 - when fast forward or fast reverse is performed.

Changing the Power illuminator

(MHC-GX45/GX35/RG440S/RG330/RG310 and MHC-RG220 (European and Russian models) only)

Press ILLUMINATION.

Each time you press the button, the power illuminator changes cyclically as follows:

For MHC-GX45/GX35/RG440S/RG330/RG310

PATTERN 1 → PATTERN 2 → PATTERN 3 →
PATTERN 4 → PATTERN 5 (FLT) → PATTERN
OFF (No display)

For MHC-RG220 (European and Russian models)

On ↔ Off (No display)

Optional Components

Hooking up optional components

To enhance your system, you can connect optional components. Refer to the operating instructions provided with each component.

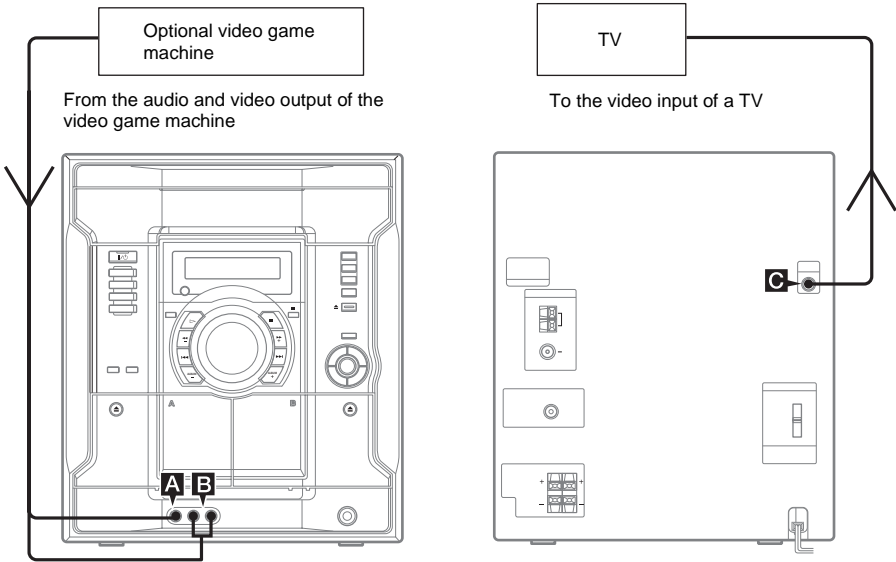

A GAME INPUT VIDEO jack

Use a video cable (not supplied) to connect the video output of the optional video game machine to this jack.

B GAME INPUT AUDIO L/R jacks

Use audio cords (not supplied) to connect the audio output of the optional video game machine to these jacks. You can then output audio through this system.

C VIDEO OUT jack

Use a video cable (not supplied) to connect the video input of TV to this jack.

Notes

- The video game machine image may appear on the TV screen even if the system is turned off.
- See “Selecting the surround effect” on page 19 for video game sound effects.
- If you press GAME on the unit while the system is off, the system turns on, the function switches to GAME, and the equalizer also switches to the GAME EQ.
- If you press GAME (MD) or GAME* while the system is on, the function switches to GAME and the equalizer automatically switches to the GAME EQ in the same manner.

* for MHC-GX25 and MHC-RG220 (except for European and Russian models)

Troubleshooting

Problems and remedies

Should you encounter a problem with your system, do the following:

- 1 Make sure the power cord and speaker cords are correctly and firmly connected.
- 2 Find your problem in the troubleshooting checklist below and take the indicated corrective action.

If the problem persists after doing all of the above, consult your nearest Sony dealer.

When the I/⏻ indicator flashes

Immediately unplug the power cord and check the following items.

- Is the voltage selector set to the correct voltage?
Check the voltage for your region, then make sure the voltage selector is set correctly.
- Are the + and – speaker cords short-circuited?
- Are you using only the prescribed speakers?
- Is anything blocking the ventilation holes on the rear of the system?

After checking the above items and fixing any problems, connect the power cord again and turn on the system. If the indicator still flashes, or if the cause of the problem cannot be found even after checking all the above items, consult your nearest Sony dealer.

General

The display starts flashing as soon as you plug in the power cord even though you have not turned on the system (see step 5 of “Hooking up the system” (page 6)).

- Press DISPLAY twice while the system is off. The demonstration disappears.

“—:—” appears in the display.

- A power interruption has occurred. Set the clock (page 8) and timer settings (pages 21 and 22) again.

The clock setting/radio presetting/timer is canceled.

- Redo the following:
 - “Setting the clock” (page 8)
 - “Presetting radio stations” (page 13)
 - “Check the setting” (page 21)
 - “Timer recording radio programs” (page 21)

There is no sound.

- Press VOL +/- or turn VOLUME control on the unit clockwise.
- Make sure the headphones are not connected.
- Check the speaker connections (page 6).
- There is no audio output during timer-recording.

Sound comes from one channel, or unbalanced left and right volume.

- Place the speakers as symmetrically as possible.
- Connect the supplied speakers.

Sound lacks bass.

- Check that the speaker’s + and – jacks are connected correctly.

There is severe hum or noise.

- Move the system away from the source of noise.
- Connect the system to a different wall outlet.
- Install a noise filter (commercially available) to the mains line.

The timer cannot be set.

- Set the clock again (page 8).

The timer does not function.

- Check the timer setting and set the correct time (pages 21 and 22).
- Cancel the Sleep Timer Function (page 20).

The remote does not function.

- Remove the obstacle.
- Move the remote closer to the system.
- Point the remote at the system’s sensor.
- Replace the batteries (R6/size AA).
- Locate the system away from the fluorescent light.

There is acoustic feedback.

- Reduce the volume.

The color irregularity on a TV screen persists.

- Turn off the TV set once, then turn it on after 15 to 30 minutes. If the color irregularity still persists, place the speakers farther away from the TV set.
-

CD/MP3 player

The disc tray does not open and “LOCKED” appears.

- Contact your Sony dealer or local authorized Sony service facility.

The disc tray does not close.

- Place the disc correctly.
- Always close the tray by pressing **▲** on the unit.
- Trying to press the tray closed with your fingers may cause problems with the player.

The disc does not eject.

- You cannot eject the disc during CD Synchro Recording. Press **■** to cancel the CD Synchro Recording, then press **▲** on the unit to eject the disc.
- Consult your nearest Sony dealer.

Play does not start.

- Open the disc tray and check whether a disc is loaded.
- Wipe the disc clean (page 29).
- Replace the disc.
- Place the disc that this system can play (page 4).
- Place the disc correctly.
- Place the disc in the tray with the label side up.
- Remove the disc and wipe away the moisture on the disc, then leave the system turned on for a few hours until the moisture evaporates.
- Press **▶** to start play.

The sound skips.

- Wipe the disc clean (page 29).
- Replace the disc.
- Try moving the system to a place without vibration (e.g., on top of a stable stand).
- Try moving the speakers away from the system, or placing them on separate stands. When you listen to a track with bass sounds at high volume, the speaker vibration may cause the sound to skip.

Play does not start from the first track.

- Press PLAY MODE repeatedly until both “PGM” and “SHUF” disappear to return to Normal Play.

MP3 audio track cannot be played back.*

- Recording was not performed according to the ISO 9660 level 1 or level 2 format, Joliet or Romeo in the expansion format.
- The MP3 audio track does not have the extension “.MP3”.
- The data is not stored in MP3 format.
- Discs containing files other than MPEG 1 Audio Layer-3 files cannot be played.

MP3 audio tracks take longer to play back than others.*

- After the system reads all tracks on the discs, playback may take more time than usual if:
 - the number of albums or tracks on the disc is very large.
 - the album and track organization structure is very complex.

The album title, track title and ID3 tag do not appear correctly.*

- Use a disc that conforms with ISO 9660 level 1, level 2, Joliet or Romeo in the expansion format.
- The disc ID3 tag is not ver. 1 (ver. 1.0 or 1.1).

* MHC-GX45/GX35/RG440S/RG330/RG310 and MHC-RG220 (European and Russian models) only

Tuner

Severe hum or noise/stations cannot be received.

- Set the proper band and frequency (page 13).
- Connect the antenna properly (page 7).
- Find a place and an orientation that provide good reception, then set up the antenna again. If you cannot obtain good reception, we recommend you connect a commercially available external antenna.
- The supplied FM lead antenna receives signals along its entire length, so make sure you extend it fully.
- Locate the antennas as far away from the speaker cords as possible.
- Try turning off surrounding electrical equipment.

A stereo FM program cannot be received in stereo.

- Press FM MODE (or STEREO/MONO for MHC-GX25 and MHC-RG220 (except for European and Russian models)) until “MONO” disappears.
-

Tape deck

The tape does not record or play, or there is a decrease in sound level.

- The heads are dirty. Clean them (page 30).
 - The record/playback heads are magnetised. Demagnetise them (page 30).
-

The tape does not erase completely.

- The record/playback heads are magnetised. Demagnetise them (page 30).
-

There is excessive wow or flutter, or the sound drops out.

- The capstans or pinch rollers are dirty. Clean them (page 30).
-

Noise increases or the high frequencies are erased.

- The record/playback heads are magnetised. Demagnetise them (page 30).
-

The tape does not record.

- No cassette is loaded. Load a cassette.
 - The tab has been removed from the cassette. Cover the broken tab with adhesive tape (page 30).
 - The tape has wound to the end.
-

If the system still does not operate properly after performing the above measures, reset the system as follows:

- 1 Disconnect the power cord.
- 2 Reconnect the power cord.
- 3 Press **■**, GROOVE and I/⏪ at the same time.
- 4 Press I/⏪ to turn on the system.

The system is reset to the factory settings. You should set the settings you made, such as the preset stations, clock, and timer.

Messages

One of the following messages may appear or flash in the display during operation.

CD/MP3

NO DISC

There is no disc in the player.

OVER

You have reached the end of the disc while pressing **▶▶** during playback or pause.

Precautions

On operating voltage

Before operating the system, check that the operating voltage of your system is identical with the voltage of your local power supply.

On safety

- The unit is not disconnected from the AC power source (mains) as long as it is connected to the wall outlet, even if the unit itself has been turned off.
- Unplug the system from the wall outlet (mains) if it is not to be used for an extended period of time. To disconnect the power cord (mains lead), pull it out by the plug. Never pull the cord itself.
- Should any solid object or liquid fall into the system, unplug the system and have it checked by qualified personnel before operating it any further.
- AC power cord must be changed only at the qualified service shop.

On placement

- Do not place the system in an inclined position.
- Do not place the system in locations where it is;
 - Extremely hot or cold
 - Dusty or dirty
 - Very humid
 - Subject to vibrations
 - Subject to direct sunlight.
- Use caution when placing the unit or speakers on surfaces that have been specially treated (with wax, oil, polish, etc.) as staining or discoloration of the surface may result.

On heat buildup

- Although the system heats up during operation, this is not a malfunction.
- Place the system in a location with adequate ventilation to prevent heat buildup in the system.
- If you continuously use this system at a high volume, the cabinet temperature of the top, side and bottom rises considerably. To avoid burning yourself, do not touch the cabinet.
- To prevent a malfunction, do not cover the ventilation hole for the cooling fan.

On operation

- If the system is brought directly from a cold to a warm location, or is placed in a very damp room, moisture may condense on the lens inside the CD player. Should this occur, the system will not operate properly. Remove the disc and leave the system turned on for about an hour until the moisture evaporates.
- When you move the system, take out any disc.

If you have any questions or problems concerning your system, please consult your nearest Sony dealer.

Notes on discs

- Before playing, clean the disc with a cleaning cloth. Wipe the disc from the center out.
- Do not expose the disc to direct sunlight or heat sources such as hot air ducts, nor leave it in a car parked in direct sunlight.
- When using discs that have glue or similar tacky substance on the label side of the disc or that used a special ink when the label was printed, there is a chance that the disc or label may become attached to parts inside this unit. When this occurs, it may not be possible to remove the disc, and may also cause this unit to malfunction. Be sure to check that the label side of the disc is not sticky before using.
The following types of disc should not be used:
 - Rental or used discs with attached seals where the glue extends beyond the seal. The perimeter of the seal on the disc is tacky.
 - Discs that have labels printed using a special ink that feels tacky when touched.
- Discs with non-standard shapes (e.g., heart, square, star) cannot be played on this unit. Attempting to do so may damage the unit. Do not use such discs.

Cleaning the cabinet

Clean the cabinet, panel and controls with a soft cloth slightly moistened with mild detergent solution. Do not use any type of abrasive pad, scouring powder or solvent such as thinner, benzene or alcohol.

To save a tape permanently

To prevent a tape from being accidentally recorded over, break off the cassette tab from side A or B as illustrated.

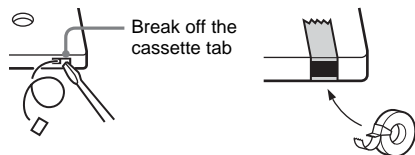

If you later want to reuse the tape for recording, cover the broken tab with adhesive tape.

Before placing a cassette in the tape deck

Take up any slack in the tape. Otherwise, the tape may get entangled in the parts of the tape deck and become damaged.

When using a tape longer than 90 minutes

The tape is very elastic. Do not change the tape operations such as play, stop, and fast-winding frequently. The tape may get entangled in the tape deck.

Cleaning the tape heads

Clean the tape heads after every 10 hours of use. Be sure to clean the tape heads before you start an important recording or after playing an old tape. Use a separately sold dry-type or wet-type cleaning cassette. For details, refer to the instructions of the cleaning cassette.

Demagnetising the tape heads

Demagnetise the tape heads and the metal parts that have contact with the tape after every 20 to 30 hours of use with a separately sold demagnetising cassette. For details, refer to the instructions of the demagnetising cassette.

Specifications

AUDIO POWER SPECIFICATIONS (MHC-GX45/GX25 USA model only)

POWER OUTPUT AND TOTAL HARMONIC DISTORTION:

With 6 ohm loads, both channels driven, from 120 – 10,000 Hz: rated 120 watts per channel minimum RMS power, with no more than 10% total harmonic distortion from 250 milliwatts to rated output.

Amplifier section

North American models: MHC-GX45

Front speaker

Continuous RMS power output (reference):

120 + 120 watts (6 ohms at
1 kHz, 10% THD)

Total harmonic distortion less than 0.07% (6 ohms at
1 kHz, 60 W)

Sub woofer

Continuous RMS power output (reference):

120 watts (6 ohms at
60 Hz, 10% THD)

Total harmonic distortion less than 0.07% (6 ohms at
60 Hz, 60 W)

MHC-GX35

Continuous RMS power output (reference):

120 + 120 watts (6 ohms at
1 kHz, 10% THD)

Total harmonic distortion less than 0.07% (6 ohms at
1 kHz, 60 W)

MHC-GX25

Continuous RMS power output (reference):

120 + 120 watts (6 ohms at
1 kHz, 10% THD)

Total harmonic distortion less than 0.07% (6 ohms at
1 kHz, 60 W)

European and Russian models:

MHC-RG440S

Front speaker

DIN power output (rated): 80 + 80 watts (6 ohms at 1 kHz, DIN)

Continuous RMS power output (reference):
100 + 100 watts (6 ohms at 1 kHz, 10% THD)

Music power output (reference):
200 + 200 watts (6 ohms at 1 kHz, 10% THD)

Sub woofer

DIN power output (rated): 80 watts (6 ohms at 60 Hz, DIN)

Continuous RMS power output (reference):
100 watts (6 ohms at 60 Hz, 10% THD)

Music power output (reference):
200 watts (6 ohms at 60 Hz, 10% THD)

MHC-RG330

DIN power output (rated): 100 + 100 watts (6 ohms at 1 kHz, DIN)

Continuous RMS power output (reference):
120 + 120 watts (6 ohms at 1 kHz, 10% THD)

Music power output (reference):
240 + 240 watts (6 ohms at 1 kHz, 10% THD)

MHC-RG310

DIN power output (rated): 80 + 80 watts (6 ohms at 1 kHz, DIN)

Continuous RMS power output (reference):
100 + 100 watts (6 ohms at 1 kHz, 10% THD)

Music power output (reference):
200 + 200 watts (6 ohms at 1 kHz, 10% THD)

MHC-RG220

DIN power output (rated): 50 + 50 watts (6 ohms at 1 kHz, DIN)

Continuous RMS power output (reference):
60 + 60 watts (6 ohms at 1 kHz, 10% THD)

Music power output (reference):
120 + 120 watts (6 ohms at 1 kHz, 10% THD)

Other models:

MHC-RG440S

The following measured at AC 120, 220, 240 V 50/60 Hz

DIN power output (rated): 80 + 80 watts (6 ohms at 1 kHz, DIN)

Continuous RMS power output (reference):
100 + 100 watts (6 ohms at 1 kHz, 10% THD)

MHC-RG330

The following measured at AC 120, 127, 220, 240 V 50/60 Hz

DIN power output (rated): 100 + 100 watts (6 ohms at 1 kHz, DIN)

Continuous RMS power output (reference):
120 + 120 watts (6 ohms at 1 kHz, 10% THD)

MHC-RG220

The following measured at AC 120, 127, 220, 240 V 50/60 Hz

DIN power output (rated): 80 + 80 watts (6 ohms at 1 kHz, DIN)

Continuous RMS power output (reference):
100 + 100 watts (6 ohms at 1 kHz, 10% THD)

Inputs

GAME INPUT AUDIO L/R (phono jacks):
voltage 250 mV,
impedance 47 kilohms

GAME INPUT VIDEO (phono jack):
1Vp-p, 75 ohms

Outputs

PHONES (stereo mini jack):
accepts headphones of
8 ohms or more

VIDEO OUT (phono jack):
max. output level 1Vp-p,
unbalanced, Sync
negative, load impedance
75 ohms

SPEAKER:
accepts impedance of 6 to
16 ohms.

SUB WOOFER OUT (MHC-GX45 and MHC-RG440S only):
accepts impedance of 6 to
16 ohms.

CD player section

System	Compact disc and digital audio system
Laser	Semiconductor laser ($\lambda=780$ nm) Emission duration: continuous
Frequency response	2 Hz – 20 kHz (± 0.5 dB)
Wavelength	780 – 790 nm
Signal-to-noise ratio	More than 90 dB
Dynamic range	More than 90 dB

Tape deck section

Recording system	4-track 2-channel, stereo
Frequency response	50 – 13,000 Hz (± 3 dB), using Sony TYPE I cassettes
Wow and flutter	$\pm 0.15\%$ W. Peak (IEC) 0.1% W. RMS (NAB) $\pm 0.2\%$ W. Peak (DIN)

Tuner section

FM stereo, FM/AM superheterodyne tuner	
FM tuner section	
Tuning range	
Russian models	65.0 – 74.0 MHz (There is no stereo effect) 87.5 – 108.0 MHz
Other models	87.5 – 108.0 MHz
Antenna	FM lead antenna
Antenna terminals	75 ohms unbalanced
Intermediate frequency	10.7 MHz
AM tuner section	
Tuning range	
Pan-American models:	530 – 1,710 kHz (with the tuning interval set at 10 kHz) 531 – 1,710 kHz (with the tuning interval set at 9 kHz)
European, Russian, Middle Eastern and Philippine models:	531 – 1,602 kHz (with the tuning interval set at 9 kHz)
Other models:	530 – 1,710 kHz (with the tuning interval set at 10 kHz) 531 – 1,602 kHz (with the tuning interval set at 9 kHz)
Antenna	AM loop antenna
Antenna terminals	External antenna terminal
Intermediate frequency	450 kHz

Speaker

North American models:

Front speaker SS-RG440 for MHC-GX45/GX25	
Speaker system	3-way, 3-unit, bass-reflex type
Speaker units	
Woofer:	13 cm, cone type
Sub woofer:	13 cm, cone type
Tweeter:	5 cm, cone type
Nominal impedance	6 ohms
Dimensions (w/h/d)	Approx. 240 × 325 × 243 mm
Mass	Approx. 4.3 kg net per speaker

Sub woofer speaker SS-WG990 for MHC-GX45

Speaker system	Bass-reflex type
Speaker units	
Woofer:	20 cm, cone type
Nominal impedance	6 ohms
Dimensions (w/h/d)	Approx. 265 × 325 × 350 mm
Mass	Approx. 6.4 kg

Canadian model:

Front speaker SS-RG660 for MHC-GX35	
Speaker system	3-way, 3-unit, bass-reflex type
Speaker units	
Woofer:	15 cm, cone type
Sub Woofer:	15 cm, cone type
Tweeter:	5 cm, cone type
Nominal impedance	6 ohms
Dimensions (w/h/d)	Approx. 240 × 363 × 290 mm
Mass	Approx. 4.7 kg net per speaker

European and Russian models:**Front speaker SS-RG440 for MHC-RG440S/RG310/RG220**

Speaker system	3-way, 3-unit, bass-reflex type
Speaker units	
Woofer:	13 cm, cone type
Sub woofer:	13 cm, cone type
Tweeter:	5 cm, cone type
Nominal impedance	6 ohms
Dimensions (w/h/d)	Approx. 240 × 325 × 243 mm
Mass	Approx. 4.3 kg net per speaker

Sub woofer speaker SS-WG990 for MHC-RG440S

Speaker system	Bass-reflex type
Speaker units	
Woofer:	20 cm, cone type
Nominal impedance	6 ohms
Dimensions (w/h/d)	Approx. 265 × 325 × 350 mm
Mass	Approx. 6.4 kg

Front speaker SS-RG660 for MHC-RG330

Speaker system	3-way, 3-unit, bass-reflex type
Speaker units	
Sub Woofer:	15 cm, cone type
Woofer:	15 cm, cone type
Tweeter:	5 cm, cone type
Nominal impedance	6 ohms
Dimensions (w/h/d)	Approx. 240 × 363 × 290 mm
Mass	Approx. 4.7 kg net per speaker

Other models:**Front speaker SS-RG660 for MHC-RG330**

Speaker system	3-way, 3-unit, bass-reflex type
Speaker units	
Sub Woofer:	15 cm, cone type
Woofer:	15 cm, cone type
Tweeter:	5 cm, cone type
Nominal impedance	6 ohms
Dimensions (w/h/d)	Approx. 240 × 363 × 290 mm
Mass	Approx. 4.7 kg net per speaker

Front speaker SS-RG440 for MHC-RG220

Speaker system	3-way, 3-unit, bass-reflex type
Speaker units	
Woofer:	13 cm, cone type
Sub woofer:	13 cm, cone type
Tweeter:	5 cm, cone type
Nominal impedance	6 ohms
Dimensions (w/h/d)	Approx. 240 × 325 × 243 mm
Mass	Approx. 4.3 kg net per speaker

General**Power requirements**

North American models: 120 V AC, 60 Hz

European and Russian models:

230 V AC, 50/60 Hz

Australian model: 230 – 240 V AC, 50/60 Hz

Argentine models: 220 V AC, 50/60 Hz

Mexican models: 127 V AC, 60 Hz

Saudi Arabian model: 120 – 127/220 or 230 – 240 V AC, 50/60 Hz
Adjustable with voltage selector

Korean model: 220 V AC, 60 Hz

Other models: 120 V, 220 V or 230 – 240 V AC, 50/60 Hz
Adjustable with voltage selector**Power consumption****USA models:**

MHC-GX45: 180 watts

MHC-GX25: 120 watts

Canadian models:

MHC-GX35: 120 watts

European and Russian models:

MHC-RG440S: 150 watts

0.35 watts (at the Power Saving Mode)

MHC-RG330: 120 watts

0.35 watts (at the Power Saving Mode)

MHC-RG310: 110 watts

0.35 watts (at the Power Saving Mode)

MHC-RG220: 80 watts

0.35 watts (at the Power Saving Mode)

Other models:

MHC-RG440S: 150 watts

MHC-RG330: 120 watts

MHC-RG220: 110 watts

Dimensions (w/h/d) Approx. 280 × 325 ×
407 mm

Mass

North American models:

HCD-GX45: Approx. 9.0 kg

HCD-GX35: Approx. 9.0 kg

HCD-GX25: Approx. 8.5 kg

European and Russian models:

HCD-RG440: Approx. 9.0 kg

HCD-RG330: Approx. 9.0 kg

HCD-RG310: Approx. 9.0 kg

HCD-RG220: Approx. 8.5 kg

Other models:

HCD-RG330: Approx. 9.0 kg

HCD-RG220: Approx. 8.5 kg

Supplied accessories: Remote Commander (1)
 Batteries (2)
 AM loop antenna (1)
 FM lead antenna (1)
 Speaker pads
 MHC-GX45/RG440S
 (12)
 MHC-GX35/GX25/
 RG330/RG310/RG220
 (8)

Design and specifications are subject to change
without notice.

Sub woofer (MHC-GX45 and MHC-RG440S only)

ALPHABETICAL ORDER

Indicator **1**

SUB WOOFER ON/OFF **2** (18)

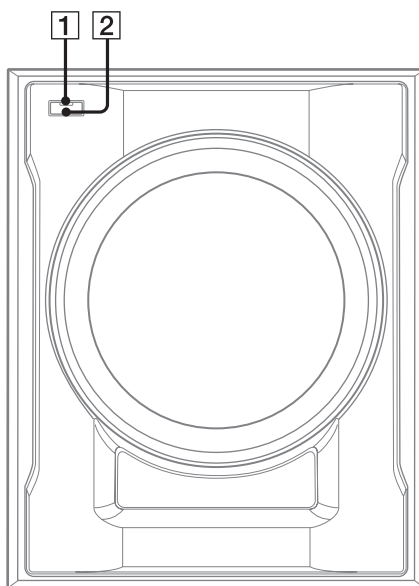

Remote control for MHC-GX45/GX35/RG440S/RG330/RG310 and MHC-RG220 (European and Russian models)

ALPHABETICAL ORDER

A - H

- ALBUM +/- **14** (10, 12)
- CD **19** (9, 12, 17)
- CLEAR **5** (12)
- CLOCK/TIMER SELECT **2** (21, 22)
- CLOCK/TIMER SET **3** (8, 20, 21)
- DISPLAY **6** (15, 22, 23)
- D. SKIP **7** (10)
- ENTER **16** (8, 12, 13, 20, 21)
- FM MODE **21** (15)
- GAME (MD)* **10** (19, 25)
- GROOVE **13** (18, 28)

I - Z

- ILLUMINATION **15** (24)
- PLAY MODE **20** (10, 12, 16)
- PRESET EQ **17** (18)
- PRESET +/- **5** (13, 14)
- REPEAT **21** (11)
- SLEEP **1** (20)
- SURROUND **11** (19)
- TAPE A/B **9** (16, 17)
- TUNER/BAND **18** (13, 14, 17)
- TUNER MEMORY **8** (13)
- TUNING +/- **5** (13, 15)
- VOL +/- **12** (18, 20)

BUTTON DESCRIPTIONS

- I/⏻ (power) **4** (7, 20, 26, 28)
- ◀◀/▶▶ (rewind/fast forward) **5** (10, 16)
- ◀◀/▶▶ (go back/go forward) **5** (8, 10, 16, 20)
- ▶ (play) **5** (10, 16)
- ⏸ (pause) **5** (10, 16)
- (stop) **5** (10, 16, 17)

* This button is used to switch to GAME function.

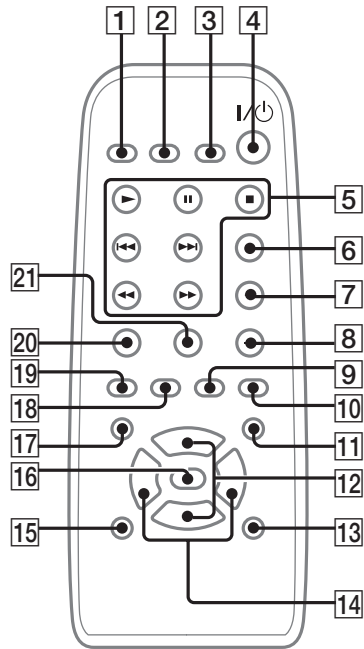

Additional Information

Remote control for MHC-GX25 and MHC-RG220 (except for European and Russian models)

ALPHABETICAL ORDER

A - N

CD **19** (9, 12, 17)
 CLEAR **20** (12)
 CLOCK/TIMER SELECT **2**
 (21, 22)
 CLOCK/TIMER SET **3** (8, 20,
 21)
 DISPLAY **6** (15, 22, 23)
 D. SKIP **7** (10)
 ENTER **15** (8, 12, 13, 20, 21)
 EQ +/- **14** (18)
 GAME **10** (19, 25)
 GROOVE **13** (18, 28)

O - Z

ON/OFF **16** (18)
 PLAY MODE **21** (10, 12, 16)
 PRESET +/- **5** (13, 14)
 REPEAT **8** (11)
 SLEEP **1** (20)
 STEREO/MONO **8** (15)
 SURROUND **11** (19)
 TAPE A/B **9** (16, 17)
 TUNER/BAND **18** (13, 14, 17)
 TUNER MEMORY **17** (13)
 TUNING +/- **5** (13, 15)
 VOL +/- **12** (18, 20)

BUTTON DESCRIPTIONS

I/⏻ (power) **4** (7, 20, 26, 28)
 ◀◀/▶▶ (rewind/fast forward)
5 (10, 16)
 ◀◀/▶▶ (go back/go forward)
5 (8, 10, 16, 20)
 ▶ (play) **5** (10, 16)
 || (pause) **5** (10, 16)
 ■ (stop) **5** (10, 16, 17)

