

LAURASTAR



IGGI

USER GUIDE

MANUÁL UŽIVATELE



2 MANUÁL UŽIVATELE IGGI



PŘED POUŽITÍM SI PŘEČTĚTE BEZPEČNOSTNÍ POKYNY^A

ZAČÍNÁME ^B



1



2

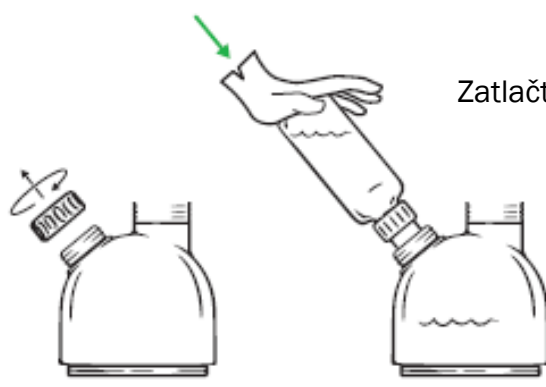

3

4



5

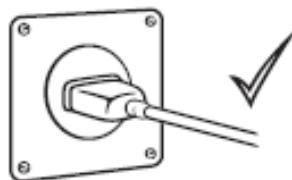

6

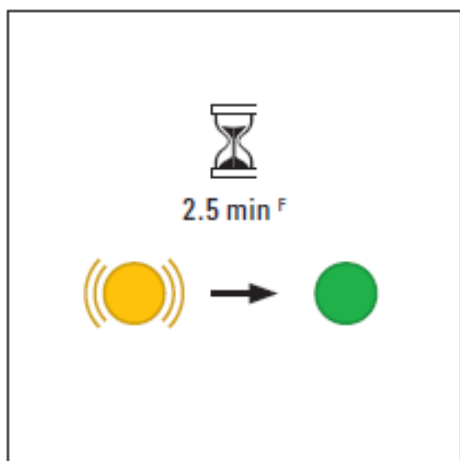

7

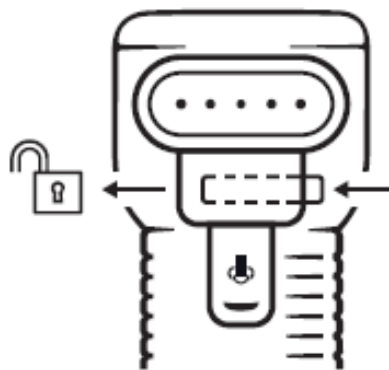

8

3 MANUÁL UŽIVATELE IGGI

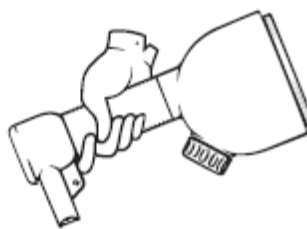
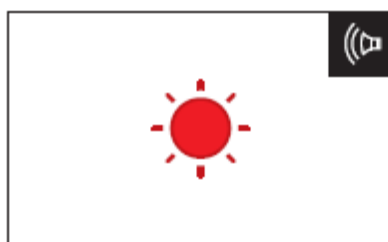
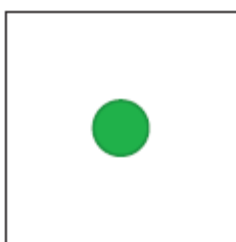

NA 10-20 SEKUND ODDÁLIT OD ODĚVU
PRO VYPAŘENÍ KONDENZÁTU ^G

9



OTŘETE TRYSKU ZAŘÍZENÍ A OD-
STRAŇTE KAPÍČKY VODY ^H

10

ZLIKVIDUJTE BAKTERIE A DEZINFIKUJTE!

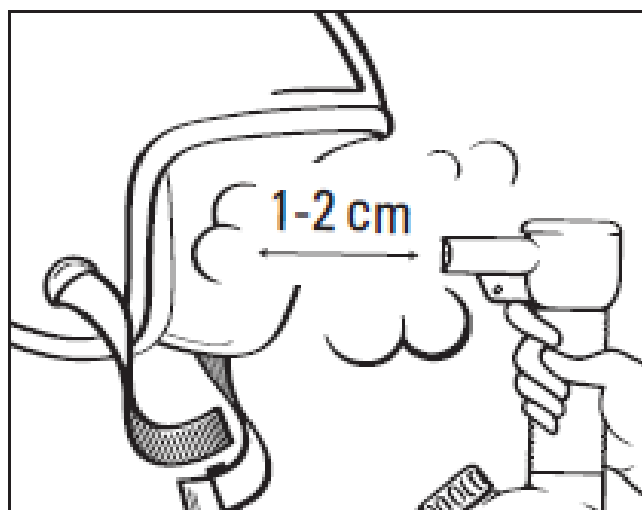
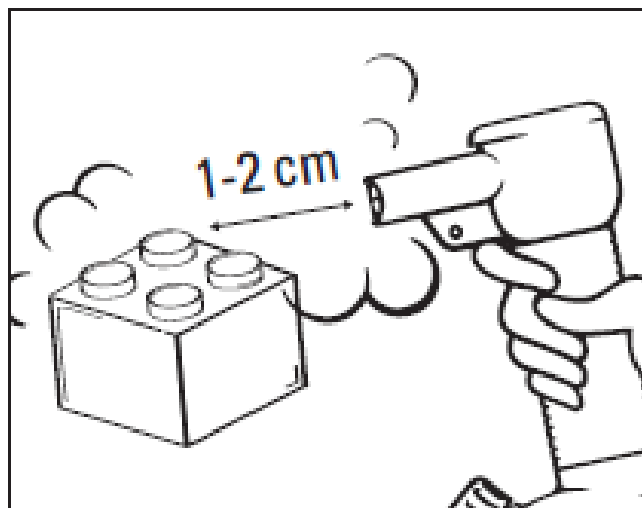
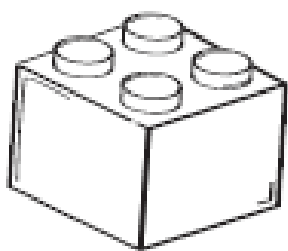
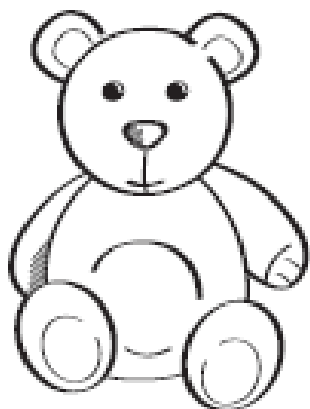

NAPAŘOVÁNÍ A PÉČE O ODĚVY J

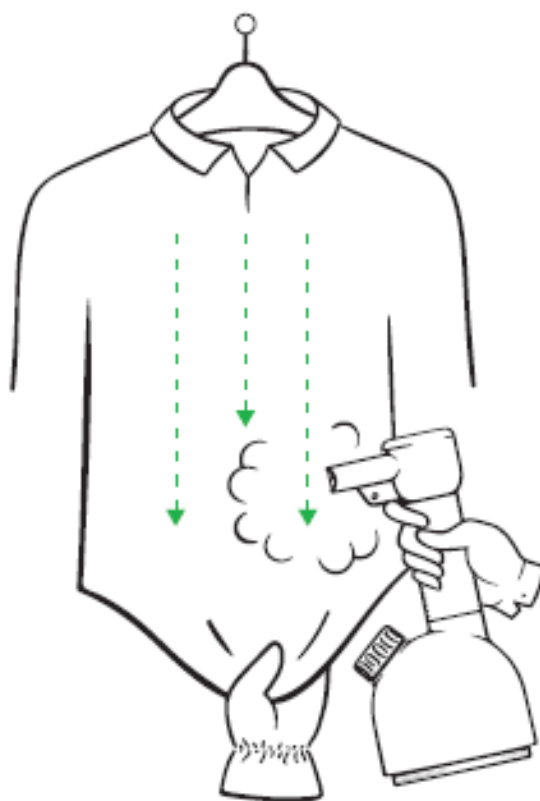
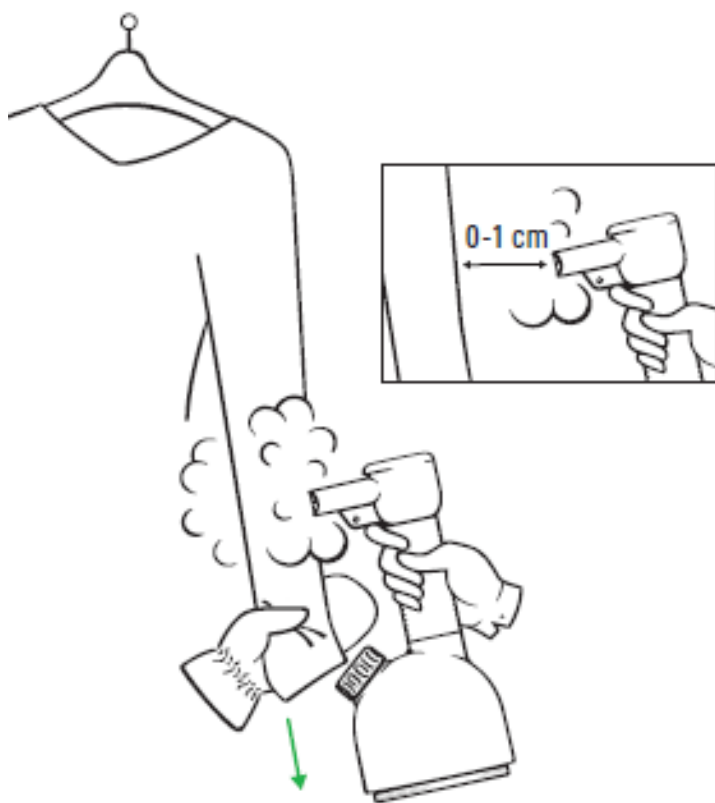

11



12

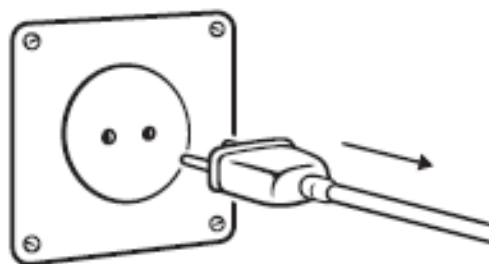

13

NÁDRŽKA JE PRAZDNÁ ^K

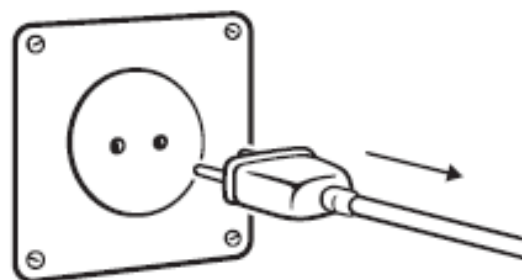
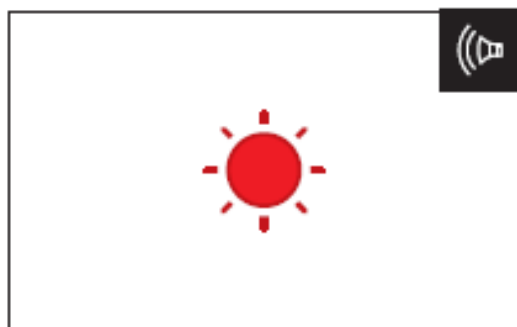

1

Bezpečnostní
zámek ^L

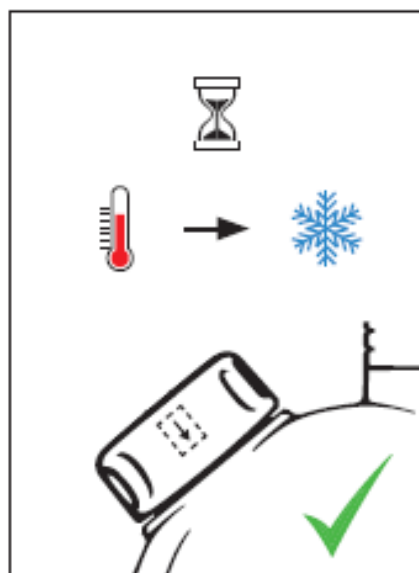

2

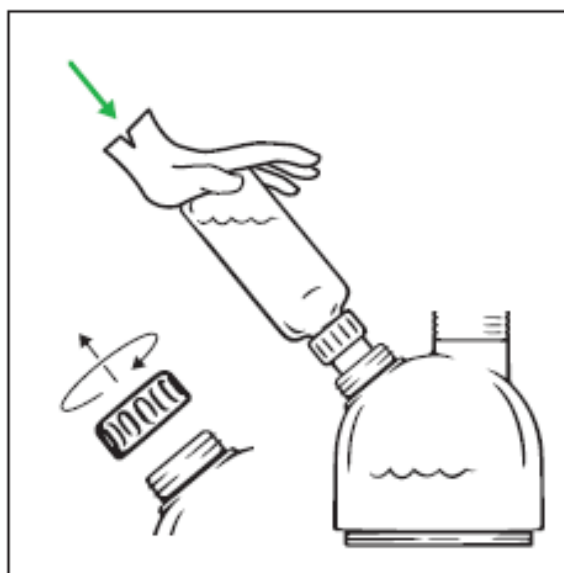

PO 15 MINUTÁCH BEZ POUŽITÍ^R



Pro probuzení zatřeste^M

1

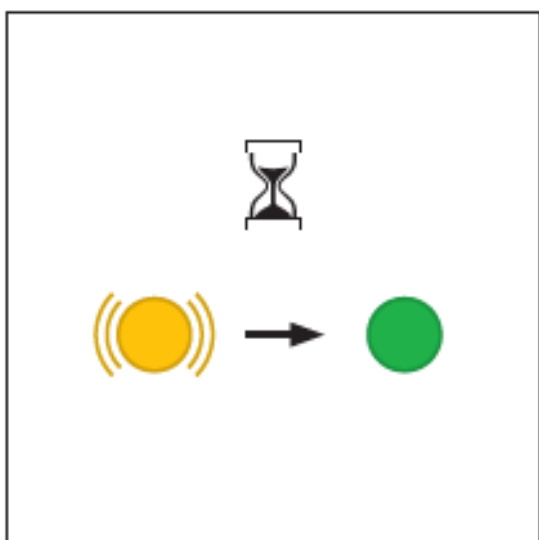

2







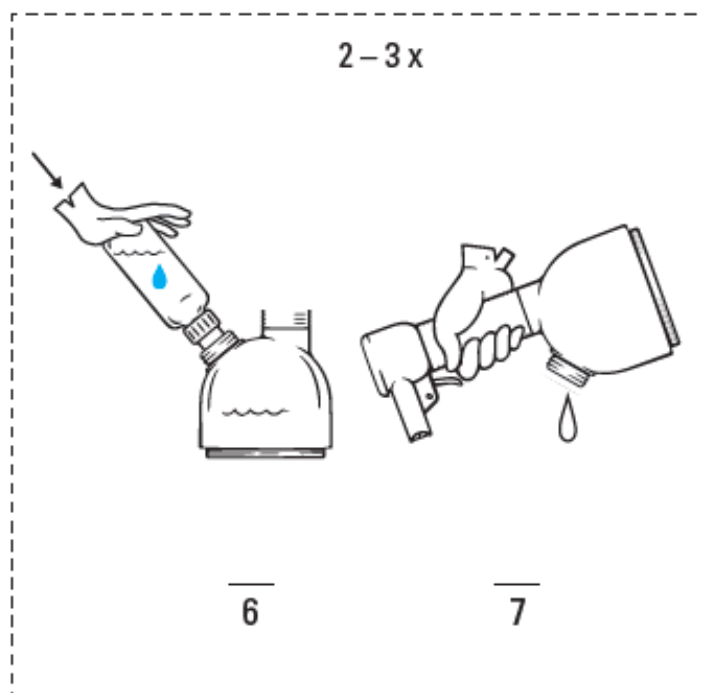
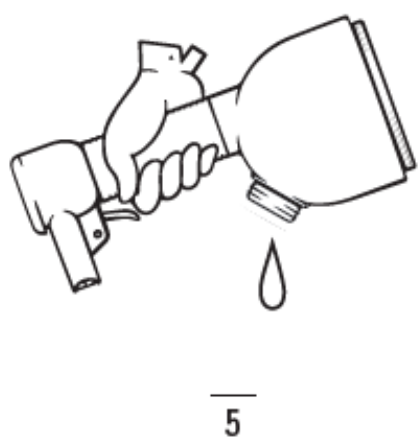
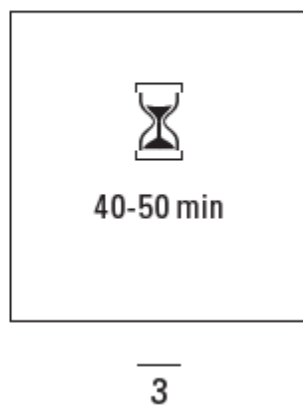
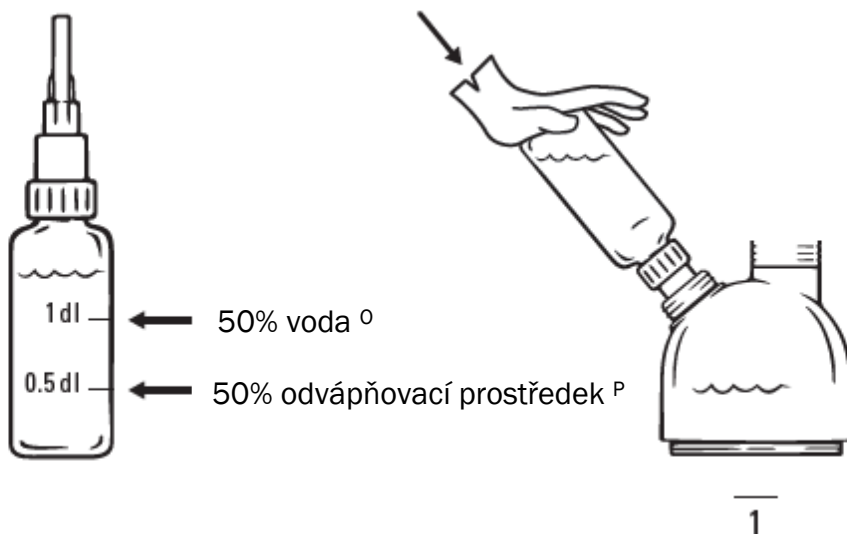



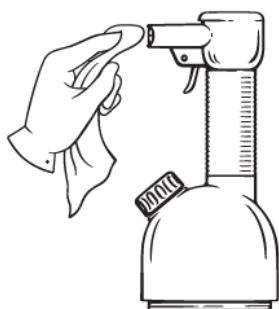













3

ÚDRŽBA 1 x / MĚSÍC_N



ÚDRŽBA PO KAŽDÉM POUŽITÍ ^Q



	 2.5 min 
 	 
	 Po 15 minutách používání ^R 
 	 
 	30 minut ochlazujte
 	 
	Kontaktujte nás

SWISS ENGINEERING | DESIGN

Copyright © 2020 for Czech Translation



BaSys CS, s.r.o.

Sodomkova 1478/8 | 102 00 Praha 10 | www.basys.cz

All rights reserved.