

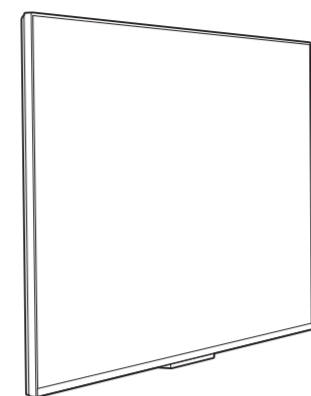

X41G50SV813D51

Register to find out more and get support
www.philips.com/TVsupport

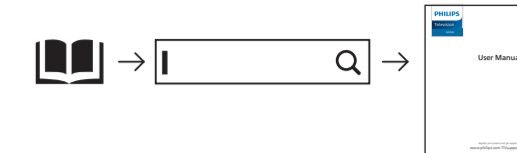

43" / 50" / 55"
65"

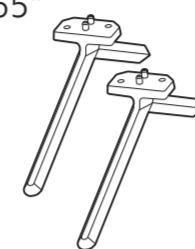

70" / 75"

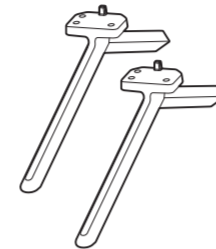

43" (Q4xL16) : x4
 50" / 55" (M4xL18) : x4
 65" (M4xL20) : x4
 70" / 75" (M5xL20) : x6

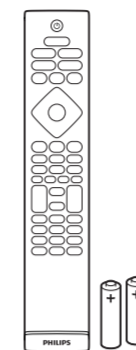

(EU)

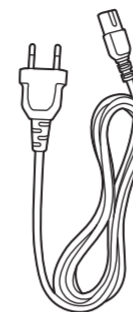

(UK)

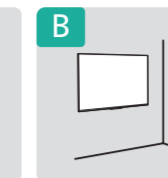
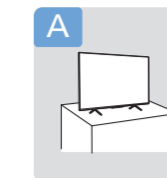
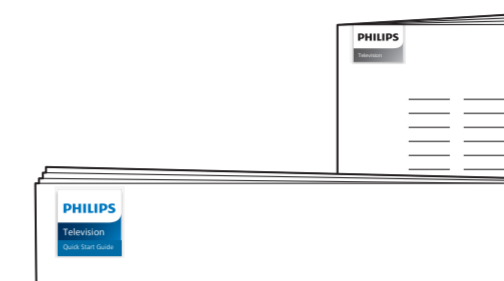
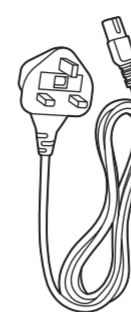

A 1a 43" / 50" / 55"

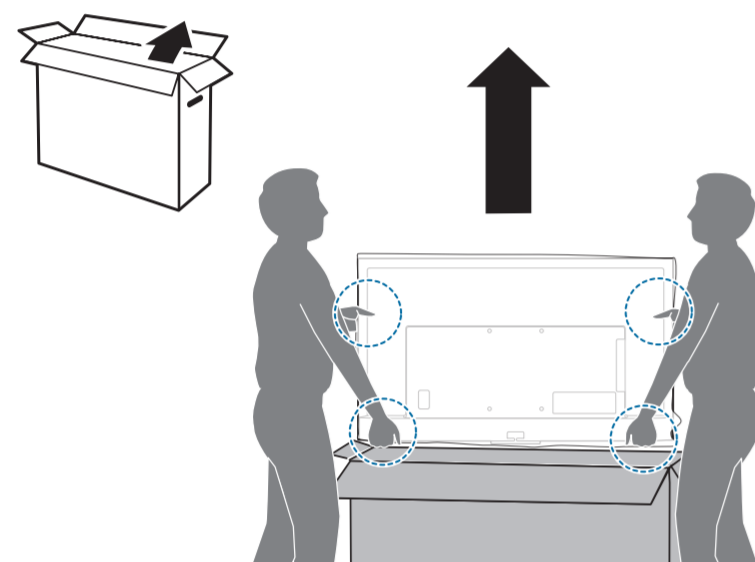

1b 65" / 70" / 75"

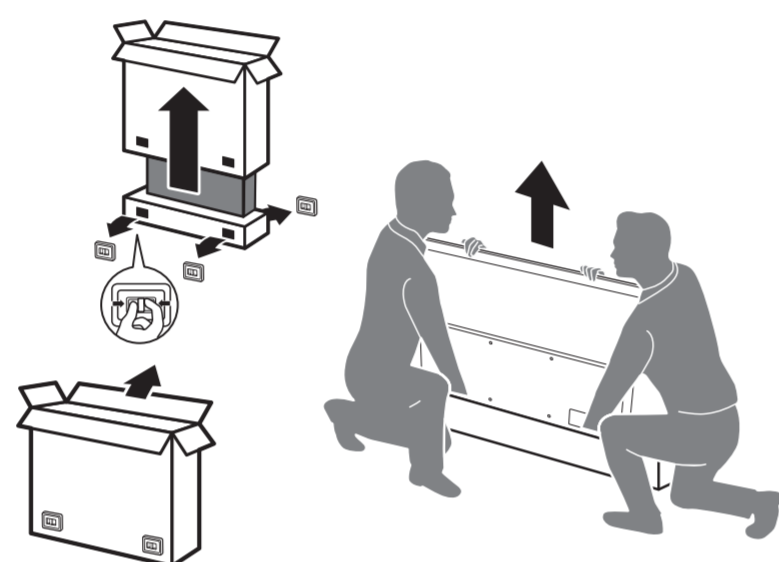

2

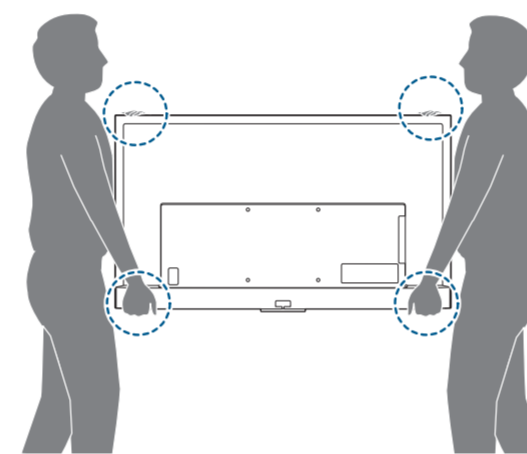
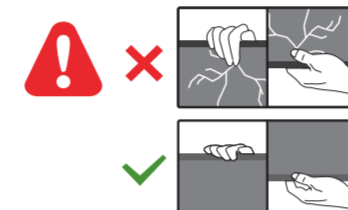

3

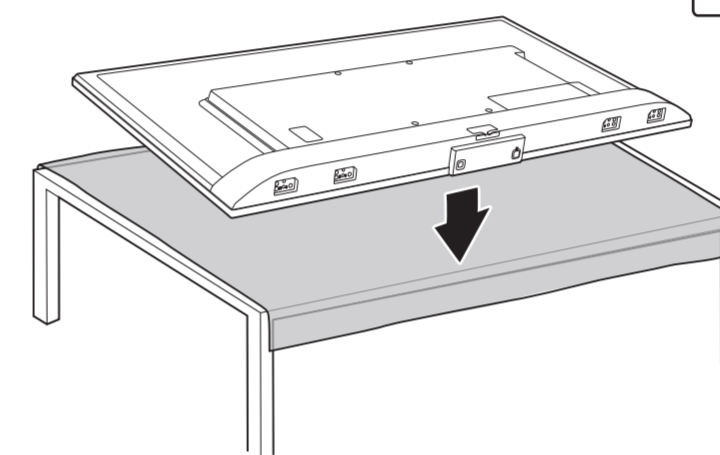

B

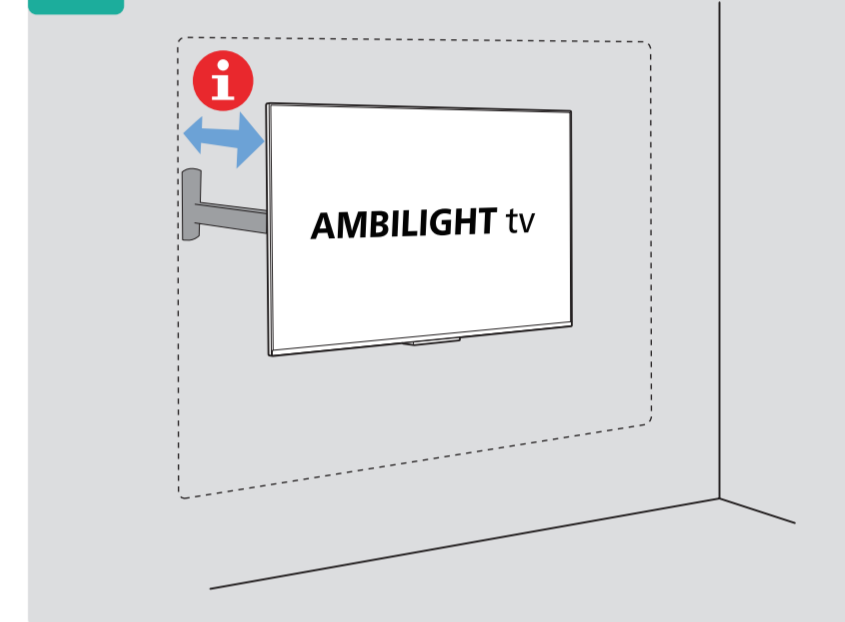

4

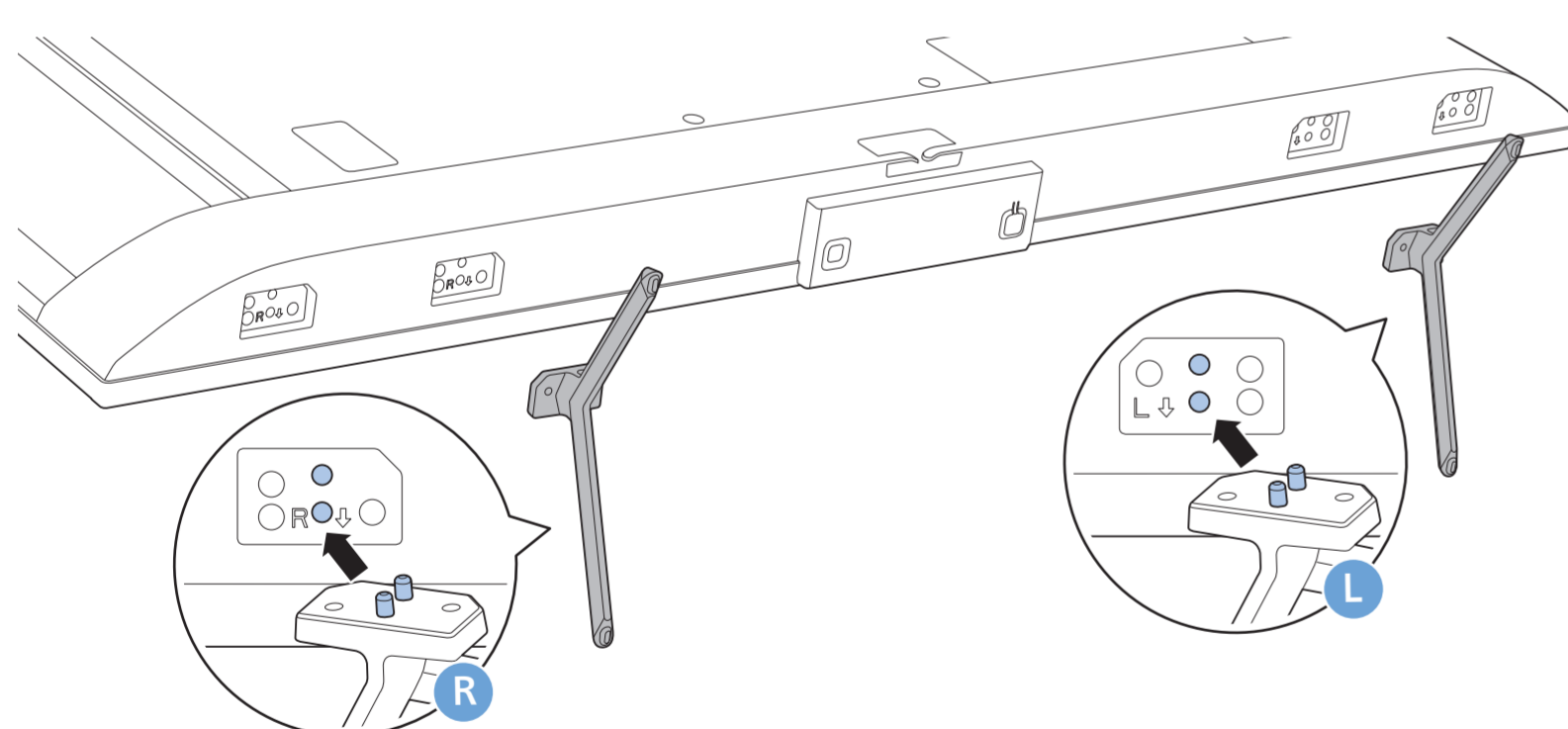

5

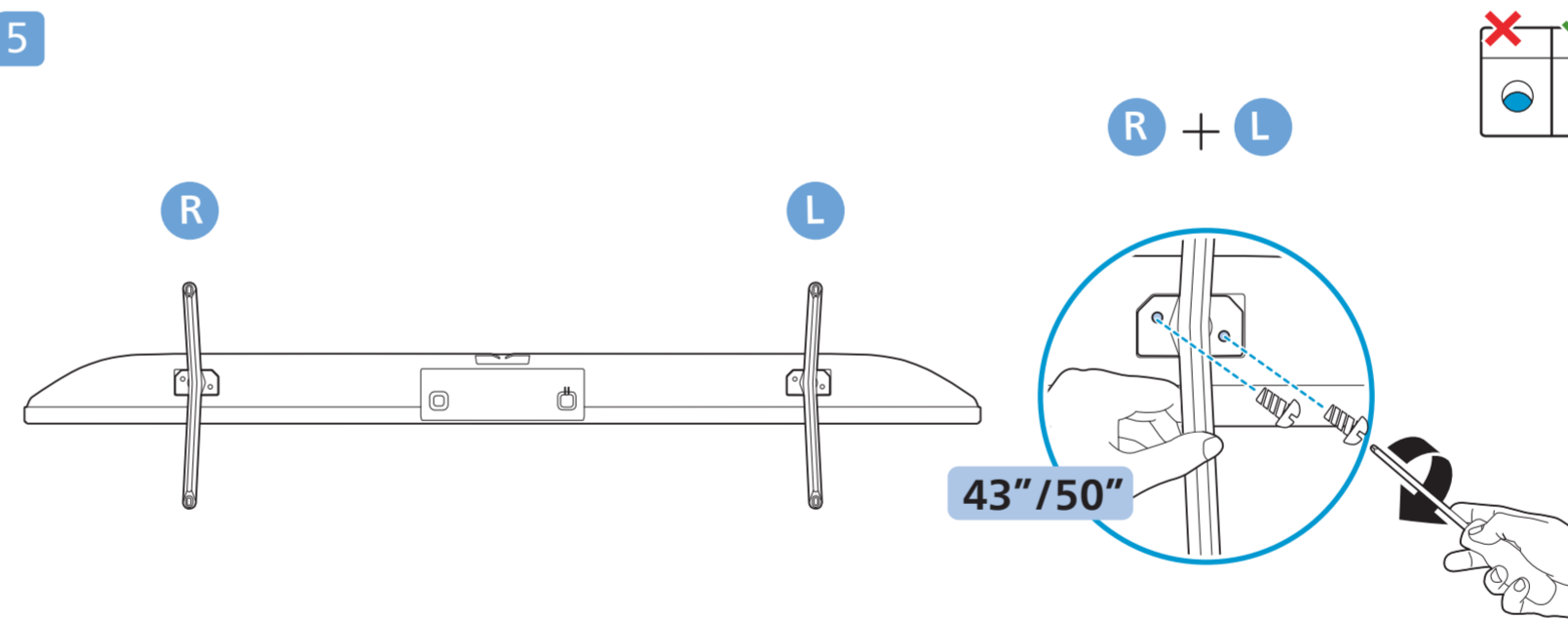

6

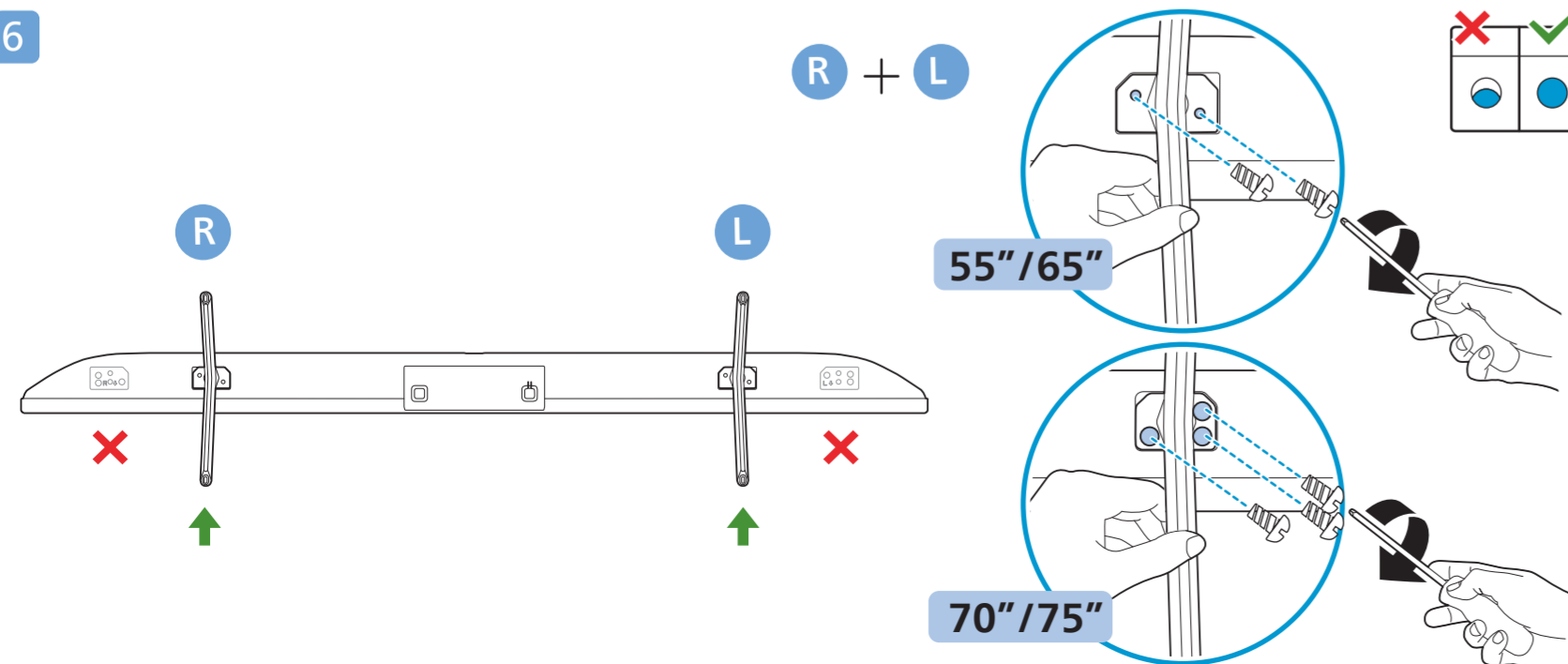

7

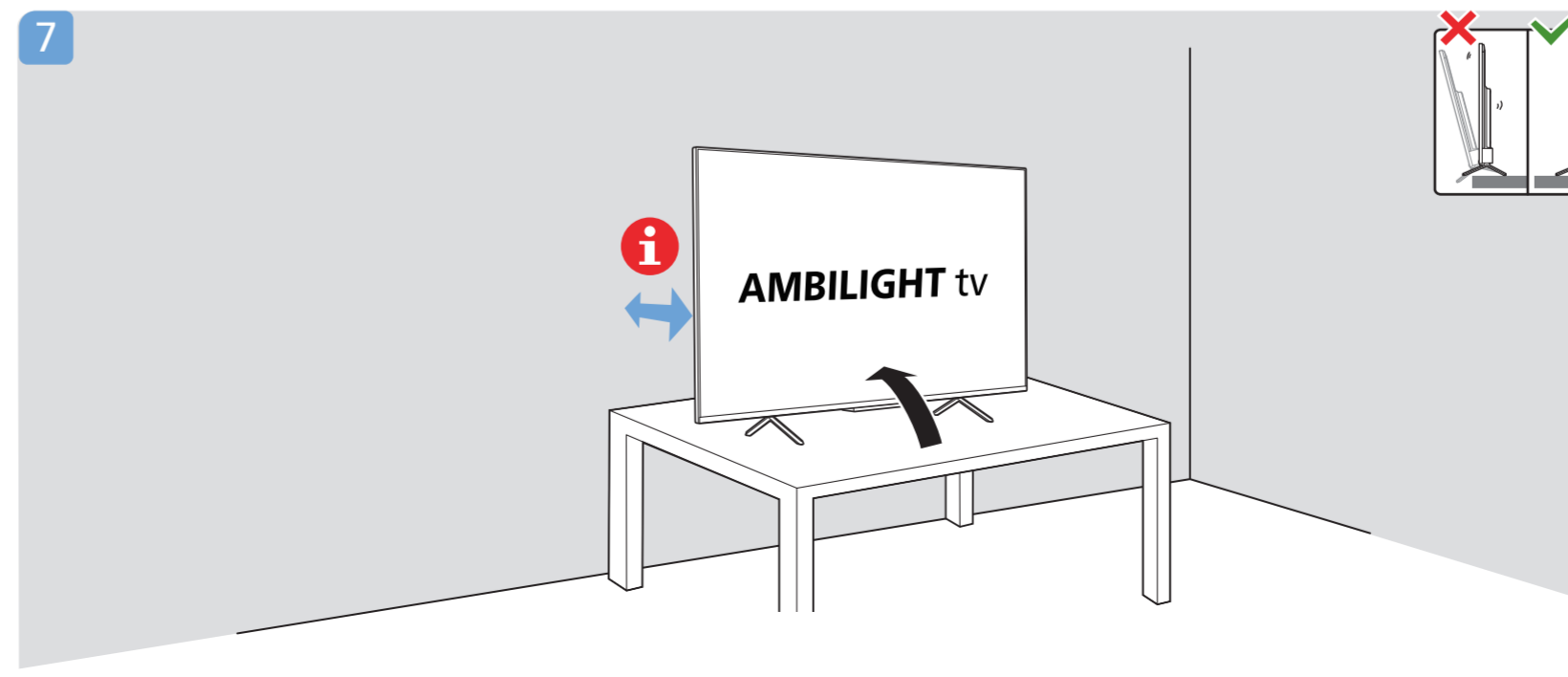

Wall Mount dimensions (x, y)



43"	100x200mm M6 (L: 10mm~12mm)	108 cm
50"	200x300mm M6 (L: 10mm~16mm)	126 cm
55"	200x300mm M6 (L: 10mm~16mm)	139 cm
65"	300x300mm M6 (L: 12mm~20mm)	164 cm
70"	300x300mm M8 (L: 12mm~25mm)	177 cm
75"	300x300mm M8 (L: 12mm~25mm)	189 cm

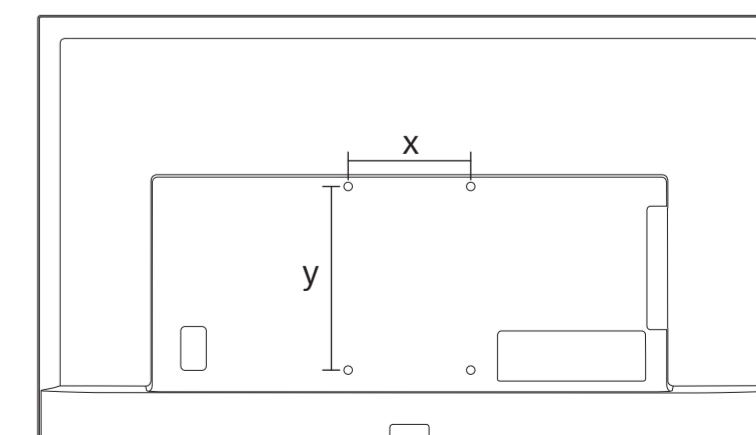

Obsah je uzamčen

Dokončete, prosím, proces objednávky.

Následně budete mít přístup k celému dokumentu.



Proč je dokument uzamčen? Nahněvat Vás rozhodně nechceme. Jsou k tomu dva hlavní důvody:

1) Vytvořit a udržovat obsáhlou databázi návodů stojí nejen spoustu úsilí a času, ale i finanční prostředky. Dělali byste to Vy zadarmo? Ne*. Zakoupením této služby obdržíte úplný návod a podpoříte provoz a rozvoj našich stránek. Třeba se Vám to bude ještě někdy hodit.

**) Možná zpočátku ano. Ale vězte, že dotovat to dlouhodobě nelze. A rozhodně na tom nezbohatneme.*

2) Pak jsou tady „roboti“, kteří se přiživují na naší práci a „vysávají“ výsledky našeho úsilí pro svůj prospěch. Tímto krokem se jim to snažíme překazit.

A pokud nemáte zájem, respektujeme to. Urgujte svého prodejce. A když neuspějete, rádi Vás uvidíme!