

HOOVER



BORN INNOVATIVE



USER MANUAL (GB)P 01
 MANUEL D'UTILISATION (FR)P 04
 BEDIENUNGSANLEITUNG (DE)P 08
 MANUALE ISTRUZIONI (IT)P 11
 GEBRUIKERSHANDLEIDING (NL)P 15
 MANUAL DE INSTRUÇÕES (PT)P 18
 MANUAL DE INSTRUCCIONES (ES)P 22
 BRUGERVEJLEDNING (DK)P 25
 BRUKSANVISNING (NO)P 29
 INSTRUKTIONSMANUAL (SE)P 32
 KÄYTTÖOHJE (FI)P 36
 ΟΔΗΓΙΕΣ ΧΡΗΣΕΩΣ (GR)P 39
 РУКОВОДСТВО ПОЛЬЗОВАТЕЛЯ (RU)P 43
 INSTRUKCJA OBSŁUGI (PL)P 46
 NÁVOD K OBSLUZE (CZ)P 50
 NAVODILA ZA UPORABO (SI)P 53
 KULLANIM KILAVUZU (TR)P 57



BORN INNOVATIVE

PRINTED IN P.R.C.
48021241

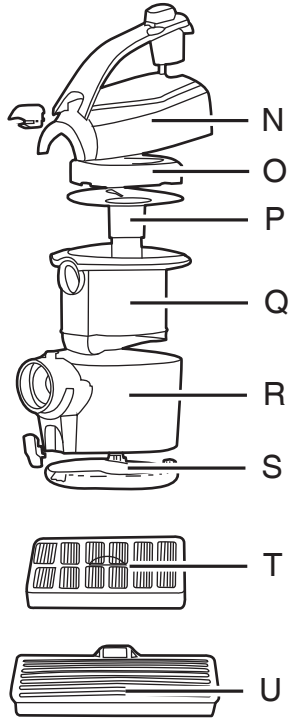
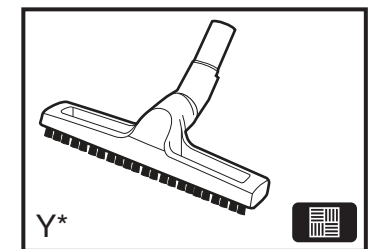
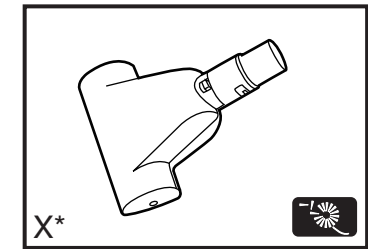
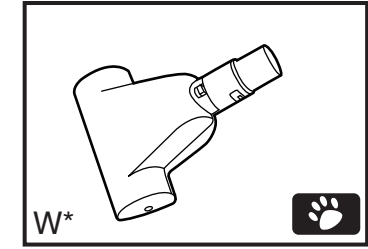
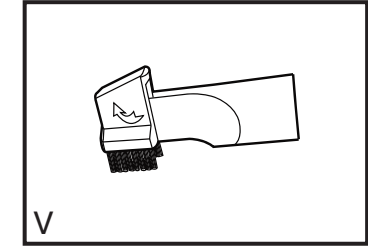
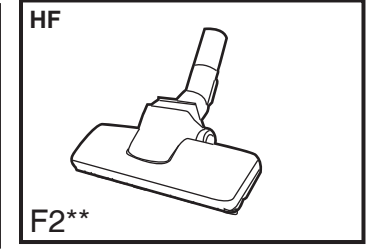
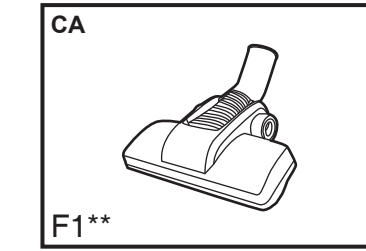
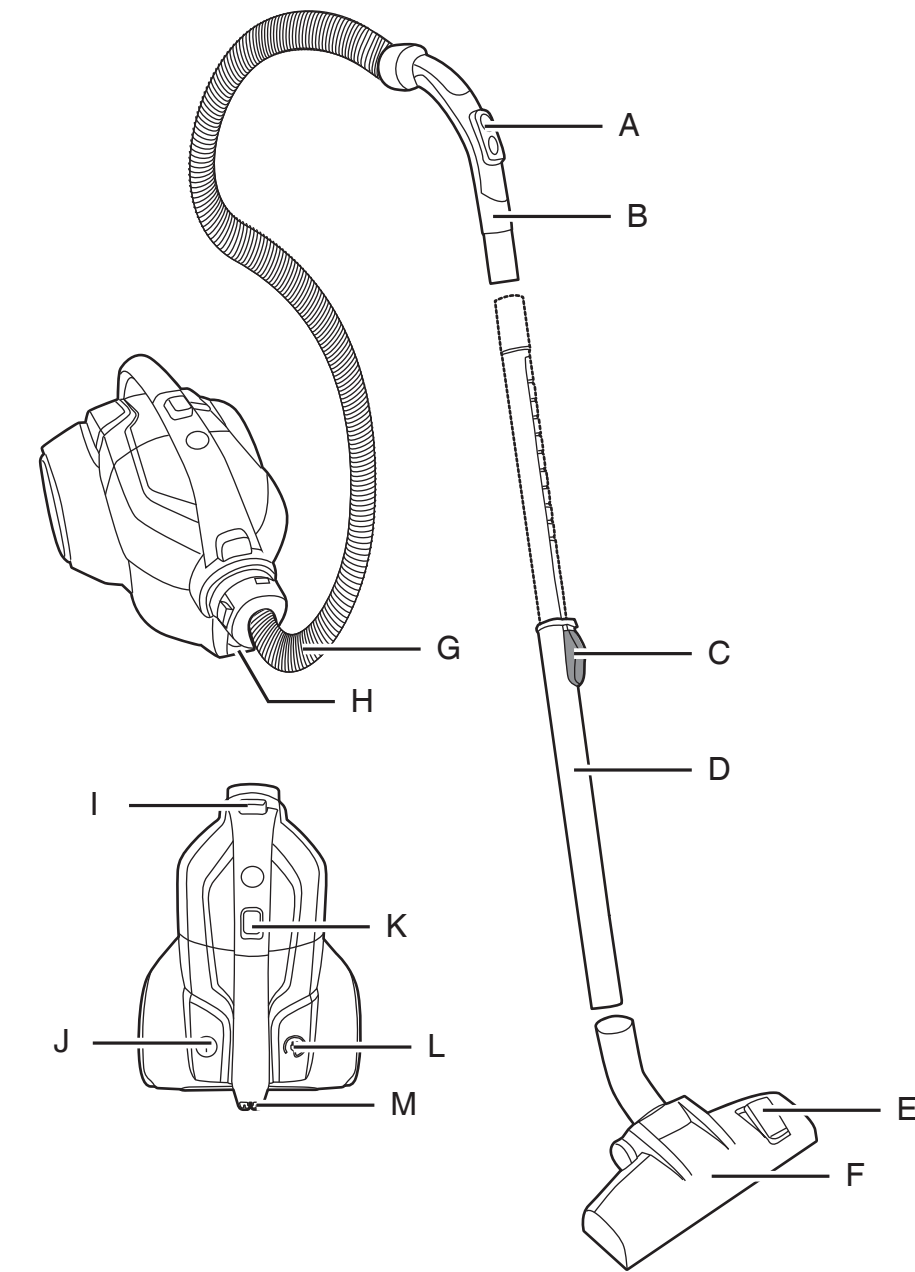

* Certain models only

** Certain models only, nozzles may vary according to model

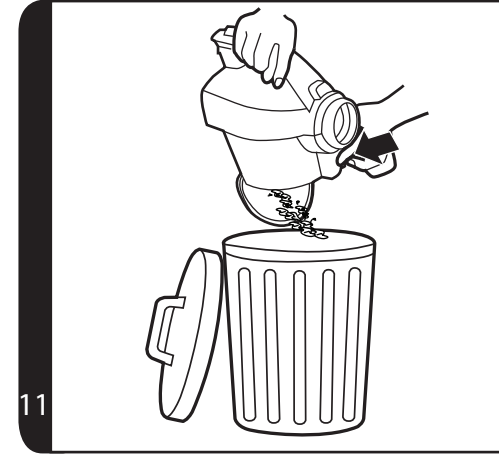
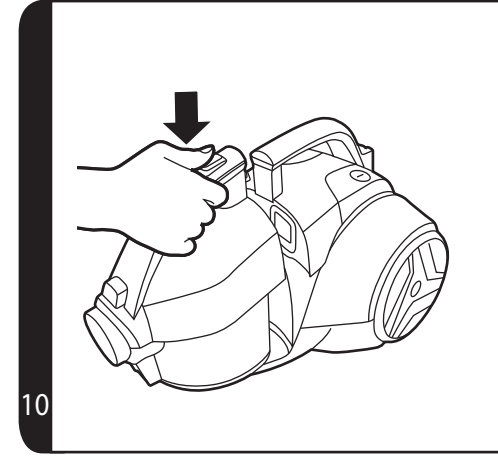
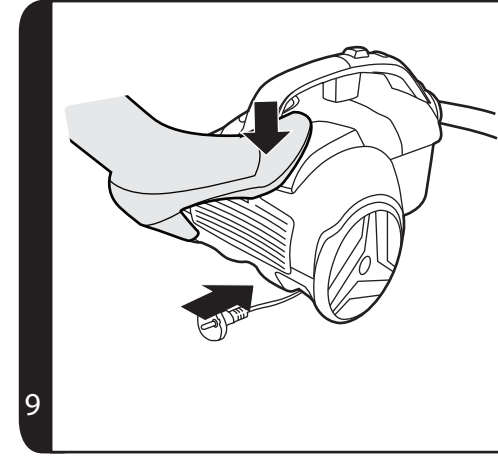
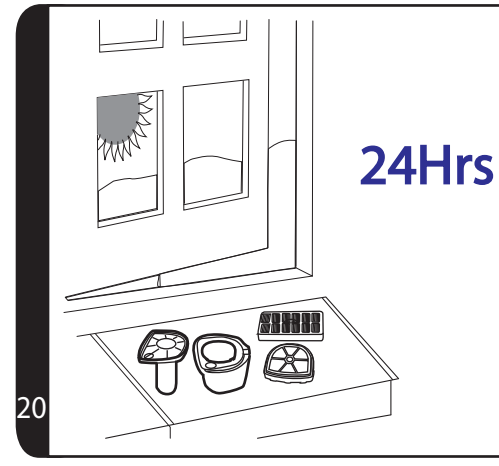
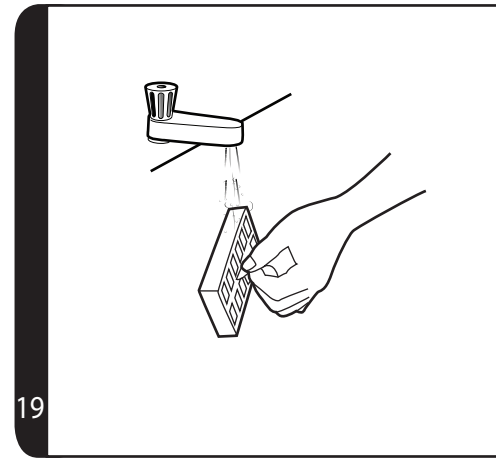
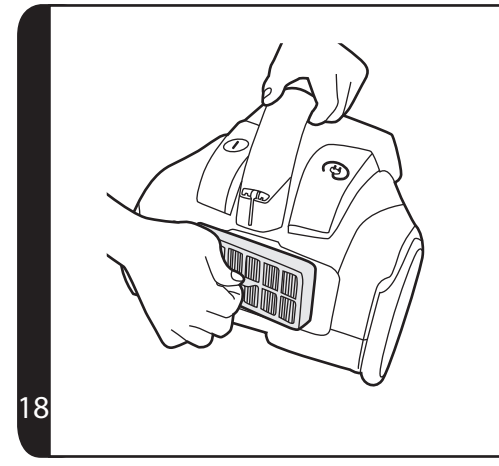
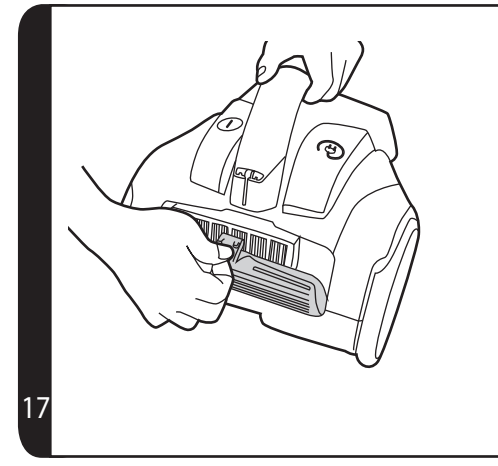
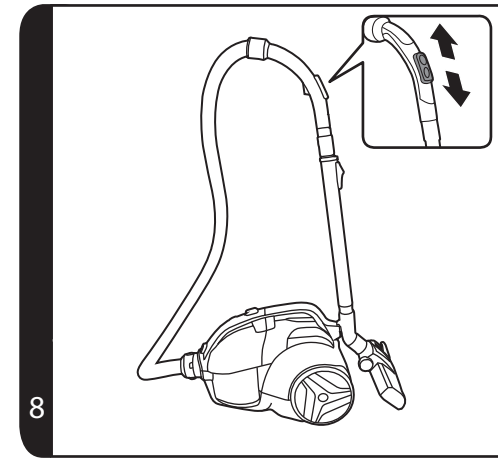
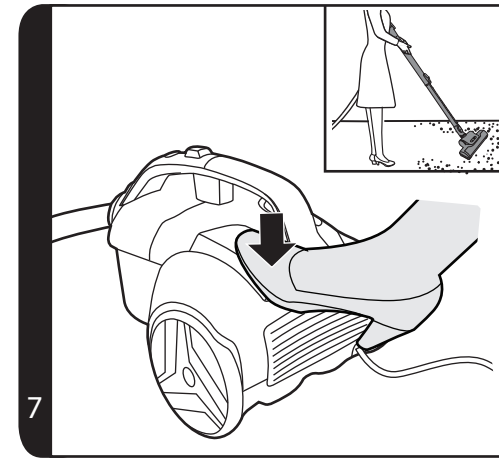
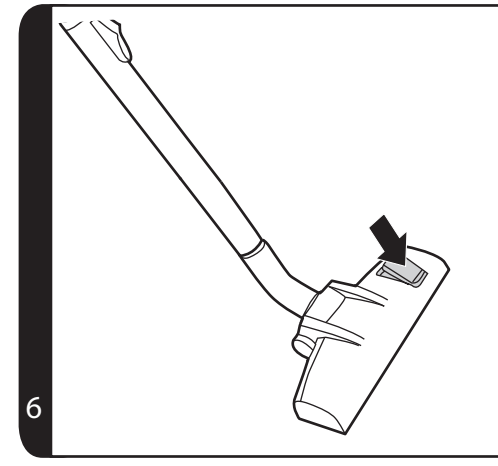
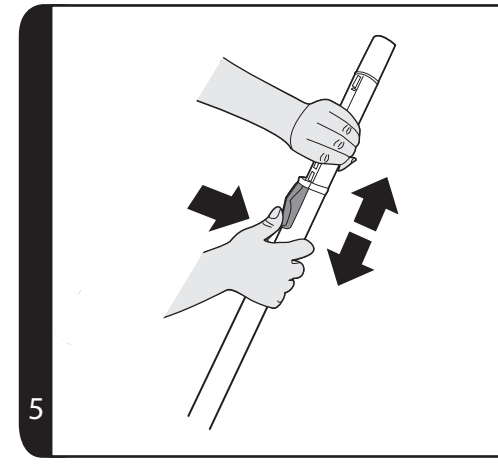
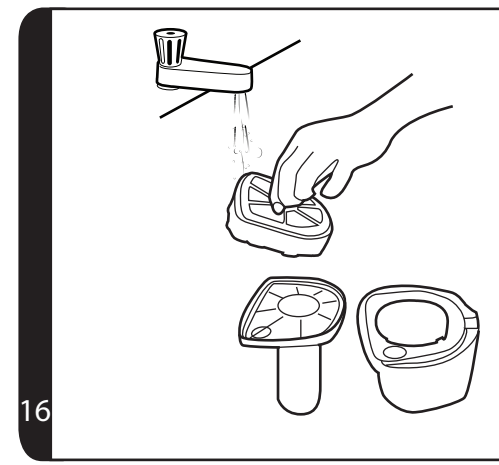
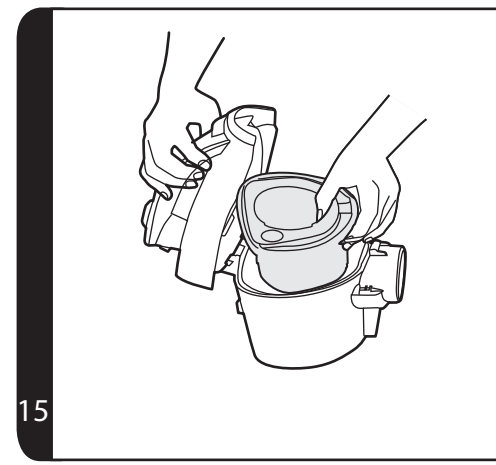
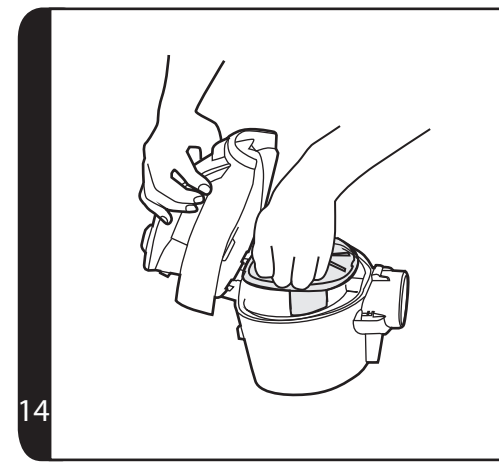
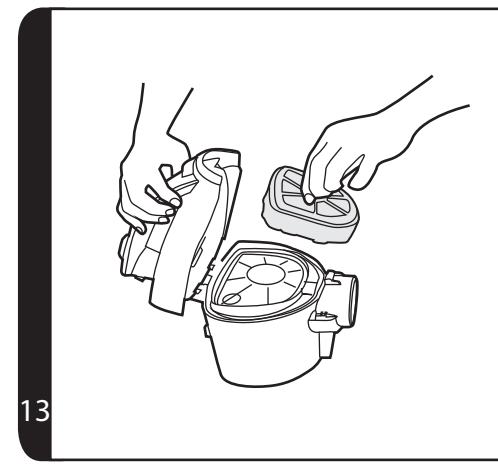
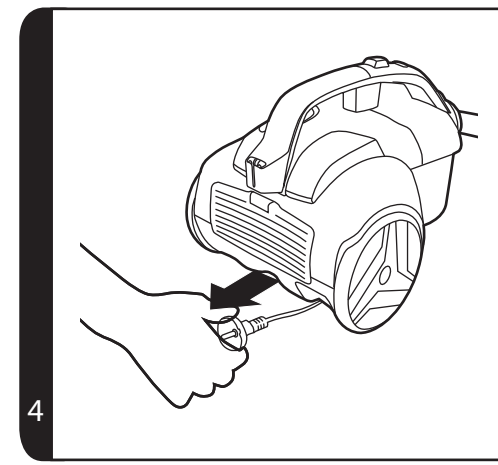
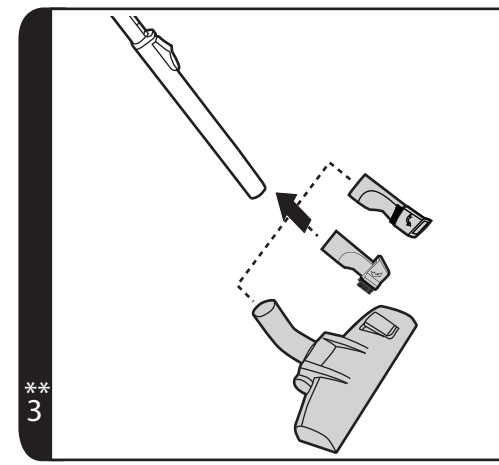
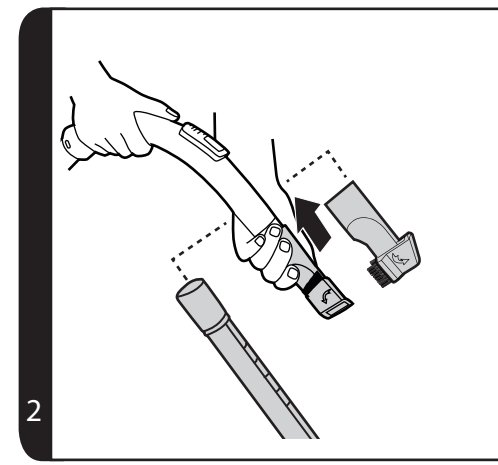
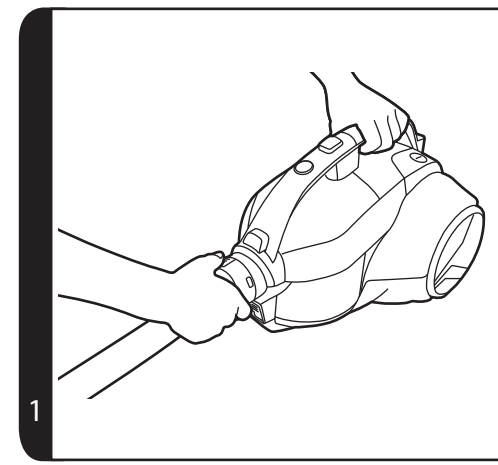

* Certain models only

** Certain models only, nozzles may vary according to model





INSTRUCTIONS FOR SAFE USE

This appliance should only be used for domestic cleaning, as described in this user guide. Please ensure that this guide is fully understood before operating the appliance.

Do not leave the appliance plugged in. Always switch off and remove the plug from the socket after use, or before cleaning the appliance or any maintenance task.

This appliance can be used by children aged from 8 years and above and persons with reduced physical, sensory or mental capabilities or lack of experience and knowledge if they have been given supervision or instruction concerning use of the appliance in a safe way and understand the hazards involved. Children shall not play with the appliance. Cleaning and user maintenance shall not be made by children without supervision.

If the power cord is damaged stop using the appliance immediately. To avoid a safety hazard, an authorised HOOVER service engineer must replace the power cord.

Keep hands, feet, loose clothing and hair away from rotating brushes.

Use only attachments, consumables or spares recommended or supplied by HOOVER.

Static electricity: Some carpets can cause a small build up of static electricity. Any static discharge is not hazardous to health.

Do not use your appliance out of doors or on any wet surface or for wet pick up.

Do not pick up hard or sharp objects, matches, hot ashes, cigarette ends or other similar items.

Do not spray with or pick up flammable liquids, cleaning fluids, aerosols or their vapours.

Do not run over the power cord when using your appliance or remove the plug by pulling on the power cord.

Do not continue to use your appliance if it appears faulty.

HOOVER service: To ensure the continued safe and efficient operation of this appliance we recommend that any servicing or repairs are only carried out by an authorised HOOVER service engineer.

Do not stand on or wrap the cord around arms or legs when using your appliance.

Do not use the appliance to clean animals or people.

Do not position the appliance above you when cleaning the stairs.

The Environment

The symbol on this appliance indicates that this appliance may not be treated as household waste. Instead it must be handed over to the applicable collection point for the recycling of electrical and electronic equipment. Disposal must be carried out in accordance with local environmental regulations for waste disposal.  For more detailed information about treatment, recovery and recycling of this appliance, please contact your local city office, your household and waste disposal service or the shop where you purchased the appliance.

 This product complies with the European Directives 2014/35/EU, 2014/30/EU and 2011/65/EU.

CANDY HOOVER GROUP S.r.l. Via Privata Eden Fumagalli, 20861 Brugherio (MB) Italy

Obsah je uzamčen

Dokončete, prosím, proces objednávky.

Následně budete mít přístup k celému dokumentu.



Proč je dokument uzamčen? Nahněvat Vás rozhodně nechceme. Jsou k tomu dva hlavní důvody:

- 1) Vytvořit a udržovat obsáhlou databázi návodů stojí nejen spoustu úsilí a času, ale i finanční prostředky. Dělali byste to Vy zadarmo? Ne*. Zakoupením této služby obdržíte úplný návod a podpoříte provoz a rozvoj našich stránek. Třeba se Vám to bude ještě někdy hodit.

**) Možná zpočátku ano. Ale vězte, že dotovat to dlouhodobě nelze. A rozhodně na tom nezbohatneme.*

- 2) Pak jsou tady „roboti“, kteří se přiživují na naší práci a „vysávají“ výsledky našeho úsilí pro svůj prospěch. Tímto krokem se jim to snažíme překazit.

A pokud nemáte zájem, respektujeme to. Urgujte svého prodejce. A když neuspějete, rádi Vás uvidíme!