

**Canon**



Photo All-in-One

# **PIXMA MP210** series

## **Quick Start Guide**



QT51208V01

# Getting Help from Canon

## Help Us Help You Better

**Before you contact Canon, please record the following information.**

Serial Number (located on the inside of the product): \_\_\_\_\_

Model Number (located on the top of the product): \_\_\_\_\_

Setup CD-ROM number (located on the CD-ROM): \_\_\_\_\_

Purchase Date: \_\_\_\_\_

## Customer Technical Support Sequence\*

### 1. Internet — [www.canontechsupport.com](http://www.canontechsupport.com)

For quick and comprehensive self-help in an intuitively guided interactive troubleshooting environment, the place to start is our helpful tech support web site. In addition, the latest driver downloads, answers to frequently asked questions, product information, and “where to buy” instructions are found here.

### 2. Email Tech Support — [www.canontechsupport.com](http://www.canontechsupport.com)

For individual attention to a special issue, try emailing our friendly technical support representatives, specially trained to communicate quick, easy, and logical solutions to your inquiries within 24 hours.

### 3. Toll-Free Live Tech Support — (1-800-828-4040)

This option provides live telephone technical support, free of service charges, Monday-Saturday (excluding holidays), during your product's 90 day limited warranty period. Telephone Device for the Deaf (TDD) support is available at (1-866-251-3752).

### 4. Extended Service and Support — [www.canonesp.com](http://www.canonesp.com)

Canon CarePAK Extended Service Plan is a cost-attractive and easy-to-use extended service program that provides up to three full years of service and support coverage at a very attractive price. CarePAK offers toll-free Canon technical support and includes Canon's superb InstantExchange product replacement program. For further information about extending your Canon service and support, call (1-800-385-2155), or visit our Web site at [www.canonesp.com](http://www.canonesp.com). CarePAK must be purchased during your product's warranty period.

For more information and updated program specifics, please visit our web site at [www.canontechsupport.com](http://www.canontechsupport.com).

\* Support program specifics are subject to change without notice.

**Canon**

**PIXMA MP210** series

**Photo All-in-One**

**Quick Start Guide**

## Copyright

This manual is copyrighted by Canon U.S.A., Inc. with all rights reserved. Under the copyright laws, this manual may not be reproduced in any form, in whole or in part, without the prior written consent of Canon U.S.A., Inc.

© 2007 Canon U.S.A., Inc.

## Disclaimer

Canon U.S.A., Inc. has reviewed this manual thoroughly in order that it will be an easy-to-use guide to your Canon PIXMA MP210 series Photo All-in-One. All statements, technical information and recommendations in this manual and in any guides or related documents are believed reliable, but the accuracy and completeness thereof are not guaranteed or warranted, and they are not intended to be, nor should they be understood to be, representation or warranties concerning the products described.

Specifications are subject to change without notice.

As an ENERGY STAR® Partner, Canon Inc. has determined that this product meets the ENERGY STAR® guidelines for energy efficiency.



All information regarding non-Canon products was compiled from publicly available information. No representation is made regarding the accuracy thereof.

## About Consumables

Consumables (ink tanks / FINE Cartridges) are available for 5 years after production has stopped.

## Trademarks

- "Microsoft" is a registered trademark of Microsoft Corporation.
- "Windows" is a trademark of Microsoft Corporation, registered in the U.S. and other countries.
- "Windows Vista" is a trademark of Microsoft Corporation.
- "Macintosh" and "Mac" are trademarks of Apple Inc., registered in the U.S. and other countries.

Canon U.S.A., Inc.  
One Canon Plaza  
Lake Success, NY 11042

# Table of Contents

- Before Using the Machine ..... 2**
  - Operation Panel ..... 2
  - Turning the Machine On and Off ..... 4
  - Handling the Original Document ..... 6
  - Loading Printing Paper ..... 7
- Copying ..... 15**
  - Making Copies ..... 15
  - Changing the Copy Settings ..... 16
  - Using Useful Copy Functions ..... 16
- Printing from Your Computer ..... 17**
  - Printing with Windows ..... 17
  - Printing with Macintosh ..... 18
- Scanning Images ..... 19**
  - Scanning Methods ..... 19
- Printing Photographs Directly from a Compliant Device ..... 20**
  - Printing Photographs Directly from a Compliant Device ..... 20
  - About PictBridge Print Settings ..... 22
- Routine Maintenance ..... 25**
  - List of Maintenance Codes ..... 25
  - When Printing Becomes Faint or Colors Are Incorrect ..... 26
  - Printing the Nozzle Check Pattern ..... 27
  - Examining the Nozzle Check Pattern ..... 28
  - Print Head Cleaning ..... 29
  - Print Head Deep Cleaning ..... 30
  - Aligning the Print Head ..... 31
  - Replacing a FINE Cartridge ..... 33
  - Keeping the Best Printing Results ..... 39
  - Cleaning Your Machine ..... 40
- Troubleshooting ..... 43**
  - An Error Code Is Displayed on the LED ..... 44
  - LED Cannot Be Seen At All ..... 46
  - Cannot Install the MP Drivers ..... 46
  - Cannot Connect to Computer Properly ..... 47
  - Print Results Not Satisfactory ..... 48
  - The Print Result Not Satisfactory When Copying ..... 52
  - Printing Does Not Start ..... 52
  - Paper Does Not Feed Properly ..... 53
  - Paper Jams ..... 54
  - Error Message Appears on the Computer Screen ..... 55
  - Error Message Appears on a PictBridge Compliant Device ..... 57
  - Scanning Problems ..... 58
- Appendix ..... 59**
  - How to Use the Documentation Provided ..... 59
  - Reading the On-screen Manuals ..... 60
  - Specifications ..... 61
- Safety Precautions ..... 64**
  - Legal Limitations on Use of Your Product and Use of Images ..... 67
  - Users in the U.S.A. .... 68
- Index ..... 72**

# Before Using the Machine

## Operation Panel

---

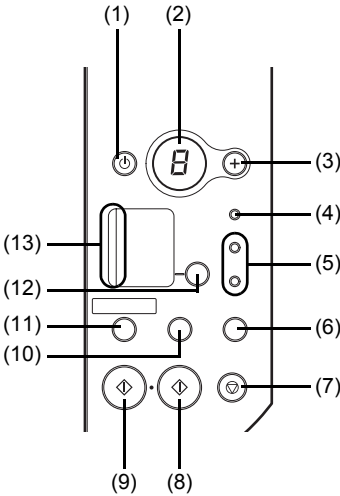

**(1) ON/OFF button / Power lamp**

Turns the machine on and off. Lights or flashes green to indicate the power status. Before turning on the machine, make sure the Document Cover is closed.

---

**Note**

**Power Lamp and Alarm Lamp**

You can check the status of the machine by the **Power** and **Alarm** lamps.

- **Power** lamp Off: The power is off.
- **Power** lamp lit green: The machine is ready to print.
- **Power** lamp flashing green: The machine is initializing or shutting down.
- **Alarm** lamp lit orange: An error has occurred and the machine is not ready to print.  
For details, see “An Error Code Is Displayed on the LED” on page 44.
- **Power** lamp flashing green once and **Alarm** lamp flashing orange once alternately:  
An error that requires contacting your Canon Service representative may have occurred.  
For details, see “Power Lamp Flashes Green and Alarm Lamp Flashes Orange Alternately” on page 45.

---

**(2) LED (Light Emitting Diode)**

Displays the number of copies, Maintenance menu selections or the operational status.

**(3) [+]** button

Increases the number of copies.

**(4) Alarm lamp**

Lights or flashes orange when an error, such as paper-out or ink-out, occurs.

**(5) Black/Color Ink lamps**

Lights or flashes to show the ink status.

**(6) SCAN button**

Opens the MP Navigator EX to scan a document to your computer according to the settings selected. To use this button, the machine must be connected to a computer. For details, refer to the *Scanning Guide* on-screen manual.

- (7) **Stop/Reset button**  
Cancels operations or a print job in progress.
  - (8) **Color button\***  
Starts color copying. Also, finalizes your selection for the menu or setting item.
  - (9) **Black button\***  
Starts black & white copying. Also, finalizes your selection for the menu or setting item.
  - (10)  **(Maintenance) button**  
Accesses the Maintenance menu.
  - (11) **Fit to Page button / Fit-to-Page lamp**  
Enables/disables the Fit-to-Page copying. Lights when Fit-to-Page copying is enabled.
  - (12) **Paper button**  
Switches the page size and media type for copying.  
For information on how to switch the page size between A4 and Letter, see “Setting The Default Page Size” on page 16.
  - (13) **Paper lamp**  
Displays the selected page size and media type for copying.
- \* In the software applications or manuals, the **Black** and **Color** buttons are collectively called the “**Start**” or “**OK**” button.

# Turning the Machine On and Off

---

Turn on the machine before printing.

## ■ Turning on the Machine

Before turning on the machine, confirm the following.

- The FINE Cartridges are installed properly.

If you are using the machine connected to a computer, confirm also the following.

- The machine is connected to your computer (or a compatible device).
- The MP Drivers are installed.

---

### Note

If preparatory operations above are not complete, follow your setup sheet to complete them.

---

- 1 Press the **ON/OFF** button to turn on the machine.

The **Power** lamp flashes and then remains lit green.

---

### Important

If the **Alarm** lamp begins to flash orange, see “An Error Code Is Displayed on the LED” on page 44.

---

- 2 If you are using the machine connected to a computer, turn on your computer.

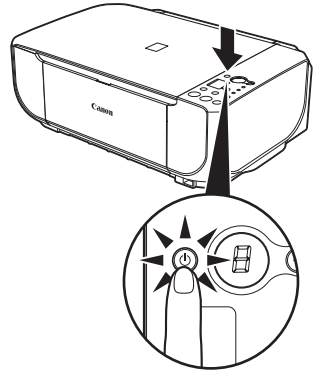

## ■ Turning off the Machine

- 1 To turn off the machine, press the **ON/OFF** button.

When the **Power** lamp stops flashing, the machine is turned off.

---

### Important

#### About the Power Plug

When removing the power plug after turning off the machine, be sure to confirm that the **Power** lamp is not lit. If the power plug is removed from the wall outlet with the **Power** lamp still lit or flashing green, the machine may become unable to print.

See “Keeping the Best Printing Results” on page 39.

---

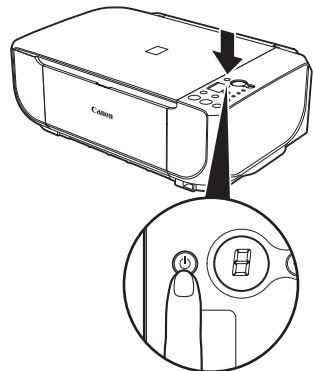



## ● Screen-saver Mode

The LED goes out if the machine is not operated for about five minutes\*.

Perform a print operation to restore the display.

\* You cannot change the wait time before the LED goes out.

---

### Note

When you want to restore the display, perform a print operation or press any button except for the **ON/OFF** button. When you press the **ON/OFF** button while the machine is in Screen-saver mode, the machine turns off.

---

# Handling the Original Document

This section describes how to load the original document on the Platen Glass.

## Original Document Requirements

The original documents you load on the Platen Glass for copying or scanning must meet these requirements:

<b>Document type</b>	<ul style="list-style-type: none"><li>● Paper documents</li><li>● Photographs</li><li>● Books</li></ul>
<b>Size (W x L)</b>	Max. 8.5 x 11.7 inches / 216 x 297 mm
<b>Thickness</b>	Max. 0.6 inches / 15 mm

## Loading Original Documents

Load originals to copy or scan on the Platen Glass.

### Note

Make sure any glue, ink, correction fluid, or the like on the original document is completely dry before loading it on the Platen Glass.

### 1 Load the original document on the Platen Glass.

- (1) Lift the Document Cover.
- (2) Load the original with the side to be copied/ scanned facing down on the Platen Glass. Place the original in landscape orientation and align the upper corner of it with the alignment mark as shown in the figure on the right.

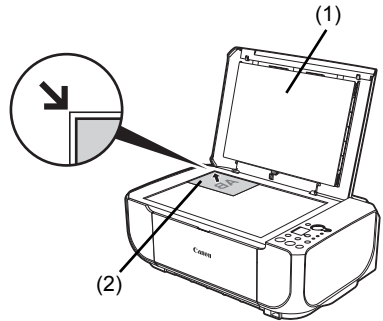

### Important

- Do not place any objects weighing more than 4.4 lb / 2 kg on the Platen Glass.
- Do not press or put weight on the original with pressure exceeding 4.4 lb / 2 kg. Doing so may cause the scanner to malfunction or the Platen Glass to break.

### Note

The machine cannot scan the shaded area in the figure below.

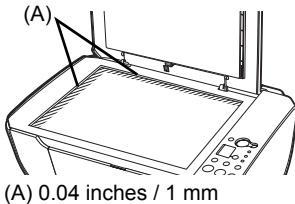

(A) 0.04 inches / 1 mm

### 2 Gently close the Document Cover.

# Loading Printing Paper

---

This section describes how to load printing paper in the Rear Tray.

## ■ Using Specialty Media

Canon recommends that you use Canon genuine media to ensure optimal print quality.

### ● Photo Quality Media

- Glossy Photo Paper
- Matte Photo Paper
- Photo Paper Plus Double Sided
- Photo Paper Plus Glossy
- Photo Paper Plus Semi-gloss
- Photo Paper Pro
- Photo Stickers



### ● Media Suited for Business Documents

- High Resolution Paper



## ■ Paper Handling

### ● Recommended Paper and Requirements

Media Type	Model <sup>*1</sup>	Paper Support Load Limit	Paper Output Tray Load Limit	Paper Thickness Lever <sup>*2</sup>	Printer Driver Setting for Media Type
Plain Paper <sup>*3</sup>	—	100 sheets	50 sheets	Left	Plain Paper
Envelopes <sup>*4</sup>	—	10 envelopes	1 envelope	Right	Envelope
High Resolution Paper <sup>*4</sup>	HR-101N	80 sheets	50 sheets	Left	High Resolution Paper
Super White Paper	SW-201	80 sheets	50 sheets	Left	Plain Paper
Glossy Photo Paper <sup>5</sup>	GP-401	A4, Letter, 5" x 7" / 127.0 x 177.8 mm and 8" x 10" / 203.2 x 254.0 mm: 10 sheets	<sup>*6</sup>	Left	Glossy Photo Paper
Glossy Photo Paper "Everyday Use" <sup>*5</sup>	GP-501	4" x 6" / 101.6 x 152.4 mm, Wide and Credit card: 20 sheets		Left	Glossy Photo Paper
Matte Photo Paper	MP-101			Left	Matte Photo Paper
Photo Paper Glossy	GP-502			Left	Glossy Photo Paper
Photo Paper Plus Semi-gloss <sup>*5</sup>	SG-101, SG-201			Left	Photo Paper Plus Glossy
Photo Paper Pro <sup>*5</sup>	PR-101			Left	Photo Paper Pro
Photo Paper Plus Glossy <sup>*5</sup>	PP-101			Left	Photo Paper Plus Glossy
Photo Paper Plus Double Sided <sup>*4*7</sup>	PP-101D	1 sheet		Left	Photo Paper Plus Double Sided
Photo Stickers	PS-101	1 sheet		Left	Photo Paper Plus Glossy
T-Shirt Transfers <sup>*4</sup>	TR-301	1 sheet		Right	T-Shirt Transfers

<sup>\*1</sup> Paper with a Model Number is Canon specialty media. Refer to the instruction manual supplied with the paper for detailed information on the printable side and notes on handling paper. For information on the paper sizes available for each Canon genuine paper, visit our website. You may not be able to purchase some Canon genuine papers depending on the country or region of purchase. Paper is not sold in the US by Model Number. Purchase paper by name.

<sup>\*2</sup> If the corners or edges of the paper are smudged, try to print with the Paper Thickness Lever set to the right. It may improve print quality.

Reset the Paper Thickness Lever to the left when you finish printing.

For details on the Paper Thickness Lever, refer to "Inside" in "Main Components" of the *User's Guide* on-screen manual.

<sup>\*3</sup> Proper feeding of paper may not be possible at the maximum capacity depending on the type of paper or environmental conditions (either very high or low temperature and humidity). In such cases, reduce the sheets of paper you load at a time to around half (around 0.2 inches / 5 mm in paper stack height).

<sup>\*4</sup> Available only when printing from your computer.

<sup>\*5</sup> When loading paper in stacks, the print side may be marked as it is fed in or sheets may be stuck to one another causing them not to be fed properly. In this case, load one sheet at a time.

<sup>\*6</sup> We recommend that you remove the previously printed sheet from the Paper Output Tray before continuously printing to avoid blurs and discoloration.

\*7 This paper cannot be used in Macintosh®.

---

### **Important**

- Put unused paper back into the package, and store them avoiding heat, humidity, and direct sunlight.
- Do not touch the printed surface nor stack the printed sheets until the ink is fixed.
- If you select "Photo Paper" when copying, use the following paper types for best printing results: GP-401, GP-501, GP-502, PP-101, SG-201.

### **Note**

For a detailed description of printing media types, refer to "Printing Media" in the *User's Guide* on-screen manual.

---

## ● **Media Types You Cannot Use**

Do not use the following types of paper. Using such paper will not only produce unsatisfactory results, but can also cause the machine to jam or malfunction. Additionally, when printing on A5 or smaller sized paper, do not use paper thinner than a post card, including plain paper or notepad paper cut to a small size.

- Folded, curled, or wrinkled paper
- Damp paper
- Paper that is too thin (weighing less than 17 lb / 64 gsm)
- Paper that is too thick (plain paper, except for Canon genuine paper, weighing more than 28 lb / 105 gsm)
- Picture postcards
- Postcards affixed with photos or stickers
- Any type of paper with holes
- Paper that is not rectangular
- Paper bound with staples or glue
- Paper with adhesives
- Paper decorated with glitter, etc.

## ■ Loading Paper

---

### ● Important

- If you cut plain paper to 4" x 6" / 101.6 x 152.4 mm, 5" x 7" / 127.0 x 177.8 mm, or 2.13" x 3.39" / 54.0 x 86.0 mm (credit card-size) for a trial print, it can cause paper jams.
- You cannot print on postcards affixed with photos or stickers.
- Always load paper in portrait orientation (A). Loading paper in landscape orientation (B) can cause the paper to be jammed.

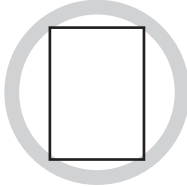

(A)

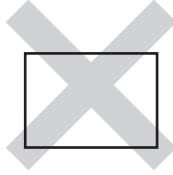

(B)

### 📖 Note

- We recommend using genuine Canon photo media when printing photographs. For details on the specialty media Canon provides for use with its various printers, see "Using Specialty Media" on page 7.

### When Printing on Plain Paper

- You can use general copy paper or Canon's Super White Paper. When printing on both sides, we recommend Canon's Super White Paper Double-Sided.  
Paper size:
    - Standard sizes: A4, B5, A5, Letter, and Legal
    - Non-standard sizes: 2.13 x 3.39 inches to 8.5 x 23 inches / 54.0 x 86.0 mm to 215.9 x 584.2 mmPaper weight: 17 to 28 lb / 64 to 105 gsm (non-Canon genuine plain paper)
- 

## 1 Flatten the four corners of the paper before loading it.

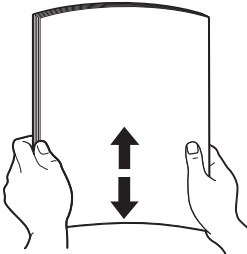

### 📖 Note

- Align the edges of paper neatly before loading. Loading paper without aligning the edges may cause paper jams.
  - If paper is curled, hold the opposing curled corners and gently bend them in the opposite direction until the paper becomes completely flat. See "Paper is curled." on page 51.
  - To avoid curling, handle paper as follows.
    - Put unused paper back into the package and keep them on a level surface.
    - Take out only the necessary number of sheets from the package, just before printing.
-

## 2 Prepare to load paper.

- (1) Open the Paper Support, then pull out the Paper Support Extension.
- (2) Open the Paper Output Tray.
- (3) Open the Output Tray Extension.
- (4) Adjust the position of the Paper Thickness Lever.  
Set it to the right when printing on envelopes or T-shirt transfers, and left when printing on any other type of paper. See "Paper Handling" on page 8.

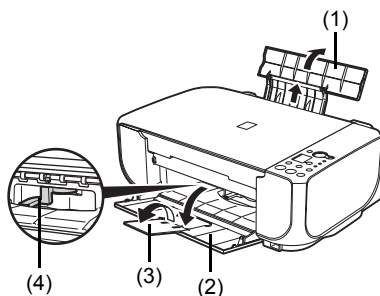

### Note

If the corners or edges of the paper are smudged, try to print with the Paper Thickness Lever set to the right. It may improve print quality.  
Reset the Paper Thickness Lever to the left when you finish printing.  
For details on the Paper Thickness Lever, refer to "Inside" in "Main Components" of the *User's Guide* on-screen manual.

## 3 Load the paper.

- (1) Load the paper in the Rear Tray with the print side facing UP.
- (2) Align the paper stack against the right side of the Rear Tray.
- (3) Pinch the Paper Guide and slide it against the left side of the paper stack.

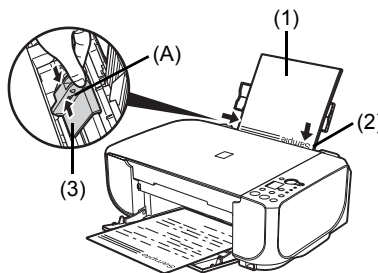

\* Do not load higher than the Load Limit Mark (A).

## 4 Specify the page size and media type settings according to the loaded paper.

### Note

- When performing copy direct printing without using a computer, select the size and type of the loaded paper using the Operation Panel.  
For details on settings, see "Making Copies" on page 15.
- When using the machine connected to a computer, select the size and type of the loaded paper in **Page Size** (or **Paper Size**) and **Media Type** in the printer driver.  
For details on printer driver settings, see "Printing with Windows" on page 17 or "Printing with Macintosh" on page 18.

## ■ Loading Envelopes

Use either European DL or US Comm. Env. #10-sized envelope.

---

### Important

- You need to print from the computer to print on envelopes.
  - Do not use the following envelopes:
    - Envelopes with a double flap (or sticker flaps)
    - Envelopes with an embossed or treated surface
    - Envelopes with pressure seals
    - Envelopes whose gummed flaps are already moistened and adhesive
- 

## 1 Prepare the envelopes.

- Press down on all four corners and edges of the envelopes to flatten them.

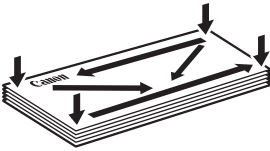

- If the envelopes are curled, hold the opposite corners and gently twist them in the opposite direction.



- If the flap of an envelope is curled, flatten it.
- If the leading edge of an envelope is puffed up or curled, use a pen to press the envelope flat and sharpen the crease. Press the envelope flat, working from the middle to the edge.

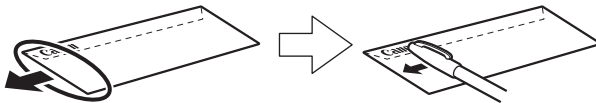

\* The above illustrations show a side view of the leading edge of the envelope.

---

### Important

The envelopes may jam in the machine if they are not flat or the edges are not aligned. Make sure that no curl or puff exceeds 0.1 inches / 3 mm.

---



## 2 Load the envelopes.

- (1) Load the envelope against the right side of the Rear Tray.  
Load with the address side facing UP and the rear flaps DOWN on the left.  
Up to 10 envelopes can be loaded at once.
- (2) Pinch the Paper Guide and slide it against the left side of the envelope.

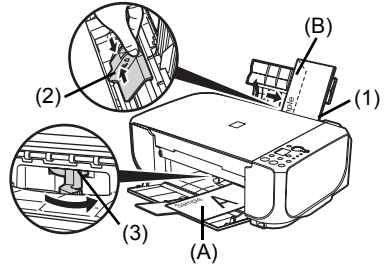

- (A) Printing orientation  
(B) Make sure the flaps are folded.

- (3) Set the Paper Thickness Lever to the right.

---

### Note

Reset the Paper Thickness Lever to the left when you finish printing. For details on the Paper Thickness Lever, refer to "Inside" in "Main Components" of the *User's Guide* on-screen manual.

---

## 3 Specify the settings in the printer driver.

- (1) Select **Envelope** in **Media Type**.
- (2) Select the size for envelopes.  
In Windows®, select **DL Env.** or **Comm. Env. #10** in **Page Size**.  
In Macintosh, select **DL Envelope** or **#10 Envelope** in **Paper Size**.
- (3) Select **Landscape** in **Orientation**.

---

### Important

Be sure to set the printer driver setting properly. If you do not, the address will be printed in the wrong direction.

### Note

For details on printer driver settings, see "Printing with Windows" on page 17 or "Printing with Macintosh" on page 18.

---

## ■ Loading Small-Sized Paper

You can use 4" x 6" / 101.6 x 152.4 mm, 5" x 7" / 127.0 x 177.8 mm, and Credit card-sized papers.

### 1 Load the paper.

- (1) Load the paper against the right side of the Rear Tray with the print side facing UP.
- (2) Pinch the Paper Guide and slide it against the left side of the paper stack.

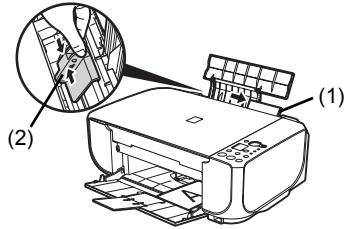

### 2 Specify the page size and media type settings according to the loaded paper.

---

#### Note

- When performing copy direct printing without using a computer, select the size and type of the loaded paper using the Operation Panel.  
For details on settings, see "Making Copies" on page 15.
  - When using the machine connected to a computer, select the size and type of the loaded paper in **Page Size** (or **Paper Size**) and **Media Type** in the printer driver.  
For details on printer driver settings, see "Printing with Windows" on page 17 or "Printing with Macintosh" on page 18.
-

# Copying

## Making Copies

---

This section describes the basic procedure to make copies.

- 1** Turn on the machine.  
See "Turning the Machine On and Off" on page 4.
- 2** Load paper.  
See "Loading Printing Paper" on page 7.
- 3** Load the original on the Platen Glass.  
See "Loading Original Documents" on page 6.
- 4** Specify the copy settings.
  - (1) Press the **+** button repeatedly to specify the number of copies (max. 20 copies).

---

 **Note**

By pressing the **+** button repeatedly, **F** will be displayed on the LED. The number of copies will be set as 20.

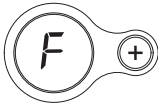

- 
- (2) Press the **Paper** button repeatedly to specify the page size and media type.  
The **Paper** lamp indicates the selected page size and media type.  
A4 or Letter Plain Paper / A4 or Letter Photo Paper / 4" x 6" Photo Paper
  - 5** Press the **Color** button for color copying, or the **Black** button for black & white copying.

# Changing the Copy Settings

---

## ■ Setting The Default Page Size

You can switch the size of paper loaded in the Rear Tray between A4 and Letter.

- 1 Press the **Maintenance** button repeatedly until **d** appears.

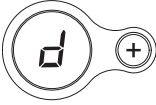

- 2 Press the **Black** button to select A4, or the **Color** button to select Letter.

## Using Useful Copy Functions

---

For details, refer to “Fit-to-Page Copying (MP210 series)” in “Making Copies” of the *User’s Guide* on-screen manual.

### Fit-to-Page Copying

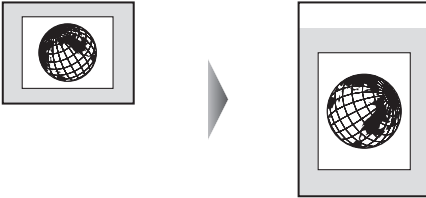

# Printing from Your Computer

This section describes procedure for basic printing.

## Printing with Windows

### Note

Depending on your application program, operations may differ. For details, refer to the instruction manual of your application.

The steps described in this section are for printing in Windows Vista™ operating system (hereafter referred to as “Windows Vista”).

- 1 Turn on the machine and load the paper in the machine.  
See “Turning the Machine On and Off” on page 4 and “Loading Printing Paper” on page 7.
- 2 Create a document or open a file to print using an appropriate application software.
- 3 Select **Print** on the application software’s **File** menu.
- 4 Make sure that **Canon XXX Printer** (where “XXX” is your machine’s name) is selected in **Select Printer**, and click **Preferences** (or **Properties**).

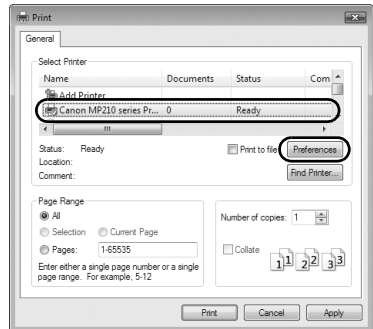

- 5 Specify the required settings and click **OK**.

### Note

For details on the printer driver functions, click **Help** or **Instructions** to view the online help or the *PC Printing Guide* on-screen manual. **Instructions** is only displayed when the on-screen manuals are installed.

- 6 Click **Print** (or **OK**).

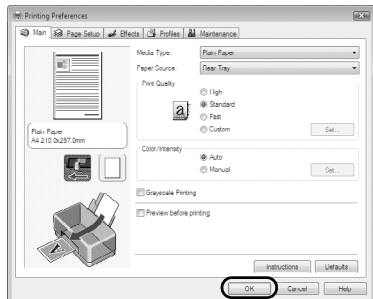

# Printing with Macintosh

## Note



Depending on your application program, operations may differ. For details, refer to the instruction manual of your application.

The steps described in this section are for printing in Mac<sup>®</sup> OS X v.10.4.x.

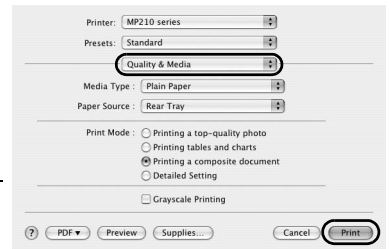
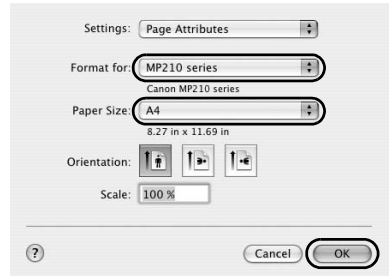
- 1 Turn on the machine and load the paper in the machine.  
See “Turning the Machine On and Off” on page 4 and “Loading Printing Paper” on page 7.
- 2 Create a document or open a file to print using an appropriate application software.
- 3 Select **Page Setup** on the application software’s **File** menu.
- 4 Make sure that your machine’s name is selected in **Format for**.
- 5 Select the page size of the loaded paper in **Paper Size**.
- 6 Click **OK**.
- 7 Select **Print** on the application software’s **File** menu.
- 8 Select **Quality & Media** in the pop-up menu.
- 9 Specify the required settings.



## Note

For details on the printer driver functions, click  to view the *PC Printing Guide* on-screen manual. If the on-screen manuals are not installed, the *PC Printing Guide* on-screen manual is not displayed even if  is clicked.

- 10 Click **Print**.

# Scanning Images

You can scan images from the machine to a computer without printing them and save them in popular image types such as JPEG, TIFF, bitmaps, or PDF. If you are scanning printed text, you can use the OCR (Optical Character Recognition) software to convert it to text data.

## Scanning Methods

---

You can select from the various scanning methods.

### ● If You Want to Edit or Print the Scanned Images

MP Navigator EX enables you to edit the scanned images, such as optimizing or trimming.

You can also start application software from MP Navigator EX to edit or print the scanned images.

For detailed operations of MP Navigator EX, refer to the *Scanning Guide* on-screen manual.

You can also use the Operation Panel to open MP Navigator EX as well as open it using the computer.

See "Opening MP Navigator EX using the Operation Panel" on page 19.

### ● If You Want to Scan Originals with Advanced Settings

ScanGear enables you to scan originals with advanced settings such as the resolution.

For detailed operations of ScanGear, refer to the *Scanning Guide* on-screen manual.

Besides the above-mentioned methods, you can use a TWAIN- or WIA- (Windows Vista and Windows XP only) compliant application software and the Control Panel (Windows Vista and Windows XP only) to scan originals with this machine. For detailed operations, refer to the *Scanning Guide* on-screen manual.

### ■ Opening MP Navigator EX using the Operation Panel

- 1 Turn on the machine.  
See "Turning the Machine On and Off" on page 4.
- 2 Load the original document on the Platen Glass.  
See "Handling the Original Document" on page 6.
- 3 Press the **SCAN** button.

# Printing Photographs Directly from a Compliant Device

You can connect a PictBridge compliant device such as a digital camera, camcorder, or mobile phone using a USB cable recommended by the device's manufacturer, and print recorded images directly without using a computer.

## ● Connectable Devices

PictBridge is an industry standard enabling a range of digital photo solutions, including the direct printing of photos from a digital still camera, camcorder or mobile phone\* without the need to use a computer. A device can be connected to this machine for direct printing regardless of the manufacturer or the model as long as it complies with the PictBridge standard.

\* PictBridge compliant digital still cameras, digital camcorders, and camera-equipped mobile phones are hereafter collectively referred to as "PictBridge compliant device".

 A device with this mark is PictBridge compliant.

## ● Printable Image Data Format

This machine prints images taken with a DCF (Design rule for Camera File system) ver. 1.0/2.0-compatible digital camera (Exif ver. 2.2/2.21 compliant), as well as PNG files.

# Printing Photographs Directly from a Compliant Device

---

To connect a PictBridge compliant device to this machine, use a USB cable recommended by the device's manufacturer.

---

### **Caution**

Do not connect any equipment other than PictBridge compliant devices to the Direct Print Port of the machine. If you do so, electric shock, fire, or damage to the machine could result.

### **Important**

Never disconnect the USB cable during printing unless when explicitly allowed to by the PictBridge compliant device. When disconnecting the USB cable between the PictBridge compliant device and machine, follow the instructions given in the device's instruction manual.

### **Note**

When printing photos with the PictBridge compliant device connected to the machine, we recommend the use of the AC adapter supplied with the device. If you are using the device battery, be sure to charge it fully.

---

## 1 Prepare for printing.

- (1) Turn on the machine.  
See "Turning the Machine On and Off" on page 4.
- (2) Load paper.  
See "Loading Printing Paper" on page 7.



## 2 Connect the PictBridge compliant device to the machine.

### Note

Depending on the model or brand of your device, you may have to select a print mode compliant with PictBridge before connecting the device. You may also have to turn on the device or select Play mode manually after connecting the device to the machine.

Perform necessary operations on the PictBridge compliant device before connecting it to this machine according to instructions given in the device's instruction manual.

- (1) Make sure that the PictBridge compliant device is turned off.
- (2) Connect the PictBridge compliant device to the machine using a USB cable recommended by the manufacturer of the device.  
The device turns on automatically.  
If your device does not turn on automatically, turn it on manually.
- (3) Set up the PictBridge compliant device for direct printing.  
 will appear on the LCD of the device when the machine is correctly connected.

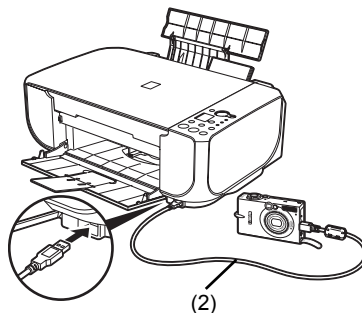

## 3 Specify the print settings such as paper type and layout.

See “About PictBridge Print Settings” on page 22.

You can make settings using the menu on the LCD of your PictBridge compliant device. Select the size and type of paper that you loaded in the machine.

If your PictBridge compliant device does not have setting menu, change the setting from the machine. For details, see “Setting on the Machine” on page 24.

## 4 Start printing from your PictBridge compliant device.

# About PictBridge Print Settings

## ■ Settings on a PictBridge Compliant Device

This section describes the print settings on a PictBridge compliant device. When operating the device, be sure to follow the instructions given in the instruction manual of your PictBridge compliant device.

### Note

- In the following description, names of setting items are given according to those used in Canon-brand PictBridge compliant devices. Setting item names may be different depending on the brand or model of your device.
- Some setting items explained below may not be available on some devices. In this case, the settings made on the machine are applied. Also, when some items are set to **Default** on a PictBridge compliant device, the machine settings for these items are applied. For details, see “Setting on the Machine” on page 24.

## ● Paper Size and Paper Type Settings

The following sizes and types of printing paper can be used when printing from a PictBridge compliant device.

- Paper size  
4" x 6" / 101.6 x 152.4 mm, 5" x 7" / 127.0 x 177.8 mm<sup>\*1</sup>, Credit card, 8" x 10" / 203.2 x 254.0 mm, A4, Letter, Wide<sup>\*1</sup>
- Paper type

Paper Type Setting	Loadable Paper <sup>*3</sup>
Plain Paper <sup>*2</sup>	Super White Paper or other plain paper
Photo	Photo Paper Plus Glossy
	Glossy Photo Paper
	Glossy Photo Paper “Everyday Use”
	Photo Paper Glossy
	Photo Paper Plus Semi-gloss <sup>*4</sup>
	Photo Stickers <sup>*5</sup>
Fast Photo	Photo Paper Pro

The available page sizes vary depending on the media type. For details, visit our website.

<sup>\*1</sup> Can be selected only on certain Canon-brand PictBridge compliant devices.

<sup>\*2</sup> **Plain Paper** can be selected for **Paper type** only when **Paper size** is set to **A4** or **8.5" x 11" (Letter)**. When **Paper type** is set to **Plain Paper**, borderless printing will be disabled even when **Layout** is set to **Borderless**.

<sup>\*3</sup> You may not be able to purchase some Canon genuine papers depending on the country or region of purchase.

<sup>\*4</sup> When printing on Photo Paper Plus Semi-gloss 8" x 10" / 203.2 x 254.0 mm (SG-201), select **20 x 25 cm/8" x 10"** for **Paper size** and **Default** for **Paper type**.

<sup>\*5</sup> Exclusively used to print photo stickers. When printing on sticker paper, select **10 x 15 cm/4" x 6"** in **Paper size** and **Photo** for **Paper type**. Do not set **Layout** to **Borderless**.

## ● Layout Setting

Various layout options are available.

- Bordered/Borderless: You can select whether or not to print an image with a border.
- N-up: You can use this option when printing on sticker paper, or A4- or Letter-sized paper.  
Sticker paper: When you select **10 x 15 cm/4" x 6"** for **Paper size**, you can print 16 images on a single sheet of paper.  
A4- or Letter-sized paper: When you select **A4** or **8.5" x 11" (Letter)** for **Paper size**, you can print 4 images on a single sheet of paper.

Besides the above options, you can also specify to print an index of images in the DPOF\* print settings menu.

\* DPOF (Digital Print Order Format) is a standard format to record the specified information regarding images, such as which image or number of copies to print.

## ● Date/File No. Print Setting

You can specify whether the date and/or file number will be printed.

---

### Note

- If the images already have dates superimposed when shot, set this PictBridge setting item to **Off**. If you select **Date**, **File No.**, or **Both**, the date and/or file number will be printed over the date printed by the device's function.
  - Depending on the paper size and layout, the date will only be printed even when **Both** is selected.
- 

## ● Image Optimize Setting

You can select the optimization method to obtain high print quality. When you select **On**, the shooting information is used to print the optimized image.

If you are using a Canon-brand PictBridge compliant device, the following additional options may be available, depending on the model.

- **VIVID** makes green and blue more lively.
- **NR** (Noise Reduction) reduces the noise on blue areas like the sky as well as on black areas.
- **Face** brightens a darkened face on the photo taken against the light.
- **Red-Eye** corrects red eyes in portraits caused by flash photography.

## ● Trimming Setting

You can select an area to print.

## ■ Setting on the Machine

This section describes the PictBridge print settings on the machine.

Set the print settings to **Default** on the PictBridge compliant device when you want to print according to the settings on the machine.

### ● Setting Items and Specifying the Settings

Setting Item	How to Specify	Corresponding Setting of PictBridge Compliant Devices <sup>*1</sup>
Page size	Press the <b>Paper</b> button repeatedly to select the page size and media type, when printing directly from a PictBridge compliant device.	Paper size
Media type	A4 or Letter Photo Paper <sup>*2</sup> , A4 or Letter Plain Paper <sup>*2</sup> , or 4" x 6" Photo Paper.	Paper type
Borderless print	Press the <b>Fit to Page</b> button to turn the lamp on to enable borderless print. <sup>*3</sup>	Layout

\*1 Set the items in this column to **Default** on the PictBridge compliant device when you want to make settings on the machine.









\*2 You can switch the page size between A4 or Letter. For details, see "Setting The Default Page Size" on page 16.

\*3 If you select Plain Paper as the media type, borderless print cannot be performed.

# Routine Maintenance

## List of Maintenance Codes

To perform maintenance of the machine, press the **Maintenance** button repeatedly until the desired code is displayed on the LED, then press the **Black** or **Color** button.

Maintenance Code	Operation	See
	Prints the nozzle check pattern.	"Printing the Nozzle Check Pattern" on page 27
	Performs Print Head Cleaning.	"Print Head Cleaning" on page 29
	Performs Print Head Deep Cleaning.	"Print Head Deep Cleaning" on page 30
	Prints the head alignment sheet.	"Aligning the Print Head" on page 31
	Scans the head alignment sheet.	"Aligning the Print Head" on page 31
	Prints the current head alignment setting.	"Aligning the Print Head" on page 31
	Cleans the paper feed roller.	"Cleaning the Paper Feed Roller (Roller Cleaning)" on page 41
	Cleans the bottom plate.	"Cleaning the Inside of the Machine (Bottom Plate Cleaning)" on page 41

# When Printing Becomes Faint or Colors Are Incorrect

---

When printing becomes faint or colors are incorrect, the print head nozzles on FINE Cartridges are probably clogged. Print the nozzle check pattern to confirm the condition of the nozzles and then perform Print Head Cleaning.

If print results are not satisfactory, performing Print Head Alignment may improve print quality.

---

## Note

### Before performing maintenance

- Make sure that a FINE Cartridge has not run out of ink. See “Getting the Ink Status Information” on page 33.
  - Make sure that a FINE Cartridge is installed properly. See “Replacing FINE Cartridges” on page 36.
  - Make sure that the orange protective tape is removed from the bottom of a FINE Cartridge.
  - If the error code is displayed on the LED, see “An Error Code Is Displayed on the LED” on page 44.
  - Increase the **Print Quality** setting in the printer driver settings.  
See “Print Results Not Satisfactory” on page 48.
- 

## Step 1

See “Printing the Nozzle Check Pattern” on page 27.

If lines are missing or if white streaks appear



## Step 2

See “Print Head Cleaning” on page 29.

If the problem is not resolved after performing  
Print Head Cleaning twice



## Step 3

See “Print Head Deep Cleaning” on page 30.

If the problem is not resolved after performing Print  
Head Deep Cleaning twice



## Step 4

See “Replacing a FINE Cartridge” on page 33.



After cleaning the Print  
Head, print and examine  
the nozzle check pattern.

---

## Note

If the straight line is misaligned or the Print Head position is misaligned, align the Print Head position.  
See “Aligning the Print Head” on page 31.

---

# Printing the Nozzle Check Pattern

---

Print the nozzle check pattern to determine whether the ink ejects properly from the print head nozzles.

- 1** Make sure that the machine is turned on, then load a sheet of A4 or Letter-sized plain paper in the Rear Tray.
- 2** Open the Paper Output Tray, then open the Output Tray Extension.  
Set the Paper Thickness Lever to the left. For details on the Paper Thickness Lever, refer to “Inside” in “Main Components” of the *User’s Guide* on-screen manual.
- 3** Print the nozzle check pattern.

(1) Press the **Maintenance** button repeatedly until **A** appears.

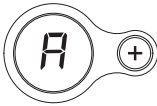

(2) Press the **Black** or **Color** button.  
The machine prints a nozzle check pattern.

- 4** Examine the pattern and take the appropriate action.  
See “Examining the Nozzle Check Pattern” on page 28.

# Examining the Nozzle Check Pattern

Examine the nozzle check pattern, and perform cleaning if necessary.

 **Note**

The nozzle check pattern will not be printed correctly if there is not enough ink. Replace the FINE Cartridge if the remaining amount of ink is insufficient. See “Replacing a FINE Cartridge” on page 33.

**1** Check the nozzle check pattern you printed.

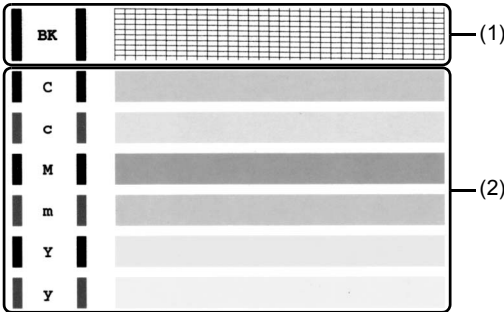

(1) If lines of this pattern are missing, the print head nozzles need cleaning.  
Example: When lines are missing (Black ink)

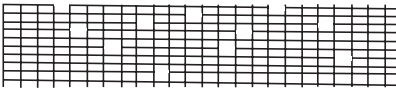

(2) If these patterns have white streaks, the print head nozzles need cleaning.  
Example: When white streaks appear (Color ink)



**2** When cleaning is necessary, perform Print Head Cleaning.

See “Print Head Cleaning” on page 29.



# Print Head Cleaning

---

Clean the Print Head if lines are missing or if white streaks appear in the printed nozzle check pattern. Cleaning unclogs the nozzles and restores the print head condition. Note that cleaning the Print Head causes used ink to be absorbed in the ink absorber. Cleaning the Print Head consumes ink, so perform Print Head Cleaning only when necessary.

- 1** Make sure that the machine is turned on.
- 2** Start Print Head Cleaning.
  - (1) Press the **Maintenance** button repeatedly until **H** appears.



- (2) Press the **Black** or **Color** button.  
Print Head Cleaning starts.

Do not perform any other operations until Print Head Cleaning finishes. This takes about one minute.

- 3** Confirm the condition of the Print Head.

When Print Head Cleaning finishes, the LED returns to the standby mode.

Print the nozzle check pattern to check the print head condition.

See "Printing the Nozzle Check Pattern" on page 27.

---

## **Note**

If the problem is not resolved after performing Print Head Cleaning twice, try Print Head Deep Cleaning. See "Print Head Deep Cleaning" on page 30.

---

# Print Head Deep Cleaning

---

If print quality does not improve by standard Print Head Cleaning, try Print Head Deep Cleaning, which is a more powerful process. Note that cleaning the Print Head causes used ink to be absorbed in the ink absorber. Print Head Deep Cleaning consumes more ink than standard Print Head Cleaning, so perform this procedure only when necessary.

- 1** Make sure that the machine is turned on.
- 2** Start Print Head Deep Cleaning.
  - (1) Press the **Maintenance** button repeatedly until **y** appears.



- (2) Press the **Black** or **Color** button.  
Print Head Deep Cleaning starts.  
Do not perform any other operations until Print Head Deep Cleaning finishes. This takes about two minutes.

- 3** Confirm the condition of the Print Head.
  - (1) Print the nozzle check pattern to check the print head condition.  
See "Printing the Nozzle Check Pattern" on page 27.
  - (2) If the problem is not resolved, perform Print Head Deep Cleaning again.
  - (3) If this does not solve the problem, a FINE Cartridge may have run out of ink. Replace it with a new one. See "Replacing a FINE Cartridge" on page 33.

# Aligning the Print Head

If ruled lines are printed misaligned or print results are otherwise unsatisfactory, adjust the print head position.

- 1 Make sure that the machine is turned on, then load a sheet of A4 or Letter-sized plain paper in the Rear Tray.
- 2 Open the Paper Output Tray, then open the Output Tray Extension.  
Set the Paper Thickness Lever to the left. For details on the Paper Thickness Lever, refer to “Inside” in “Main Components” of the *User’s Guide* on-screen manual.
- 3 Print the Print Head Alignment Sheet.

- (1) Press the **Maintenance** button repeatedly until **P** appears.

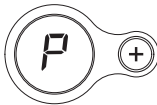

## Note

If you select **L** the machine exits the process after printing the current head position adjustment values.

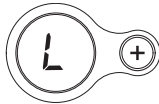

- (2) Press the **Black** or **Color** button.  
The Print Head Alignment Sheet is printed.

## 4 Adjust the print head position.

- (1) Check the printed patterns and fill in the corresponding circle (○) with a dark pencil or a black ink pen to select the number of the pattern in column A that has the least noticeable streaks.

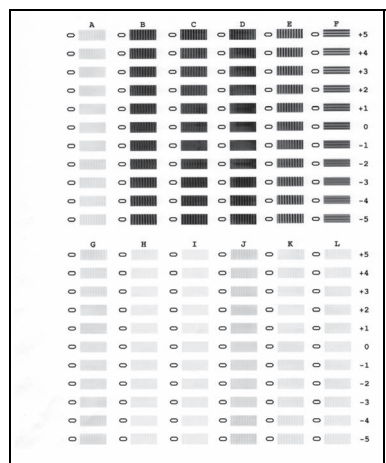

---

 **Note**

If it is difficult to pick the best pattern, pick the setting that produces the least noticeable white streaks.



(A)



(B)



(C)



(D)

- (A) Less noticeable vertical white streaks
  - (B) More noticeable vertical white streaks
  - (C) Less noticeable horizontal white streaks
  - (D) More noticeable horizontal white streaks
- 

- (2) Repeat the procedure until you finish selecting the pattern number for column L.
- (3) Place the Print Head Alignment Sheet face-down on the Platen Glass. When placing the Print Head Alignment Sheet, place the front side down and align the upper left corner of it with the alignment mark as shown in the figure below.

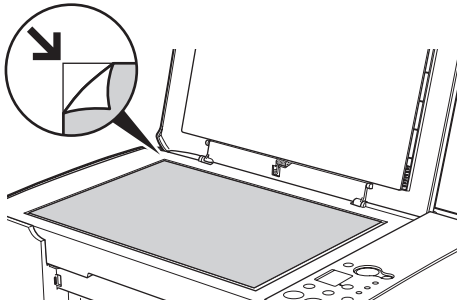

- (4) Make sure that **U** is displayed on the LED, then press the **Black** or **Color** button. The Print Head Alignment Sheet is scanned and the print head is aligned automatically.

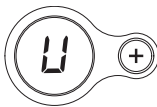

---

 **Note**

- If adjustment is not done successfully, the error code is displayed on the LED. In this case, start over from step 1 to print a new Print Head Alignment Sheet. For details, see “An Error Code Is Displayed on the LED” on page 44.
  - If the results of Automatic Print Head Alignment are not satisfactory, perform Manual Print Head Alignment. For details, refer to “Aligning Print Head on the Computer” in the *User’s Guide* on-screen manual.
  - To adjust columns M to R, you need to perform the print head alignment on your computer. For details, refer to “Aligning Print Head on the Computer” in the *User’s Guide* on-screen manual.
-

# Replacing a FINE Cartridge

---

This section explains the way to confirm the ink status and the procedure to replace FINE Cartridges.

When ink runs out or other errors occur, an error code is displayed on the LED to inform you of the error. See “An Error Code Is Displayed on the LED” on page 44 and confirm how to handle it.

When printing from your computer, error messages appear on your computer screen as well.

---

## Note

- If there is no improvement with the quality of printing following such maintenance as Print Head Cleaning, a FINE Cartridge is probably empty. When ink runs out, replace the FINE Cartridge. The machine cannot print if the wrong type of FINE Cartridge is used.
  - For information on compatible FINE Cartridges, see the back cover of this guide.
- 

## ■ Getting the Ink Status Information

You can confirm the status of FINE Cartridges in the following ways:

- “With the Ink Lamps” on page 33
  - “With the Computer Screen” on page 34
- 

## Note

The ink level detector is mounted on the machine to detect the remaining ink level. The machine considers as ink is full when a new FINE Cartridge is installed, and then starts to detect a remaining ink level. If you install a used FINE Cartridge, the indicated ink level of it may not be correct. In such case, refer to the ink level information only as a guide.

---

## ● With the Ink Lamps

Make sure that the LED is on the standby mode. You can confirm the status of each cartridge by the ink lamps.

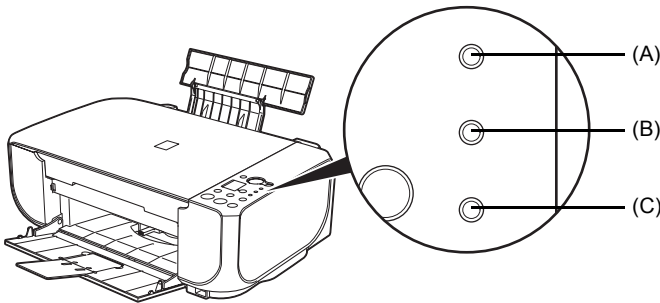

- (A) **Alarm** lamp
- (B) **Black Ink** lamp
- (C) **Color Ink** lamp

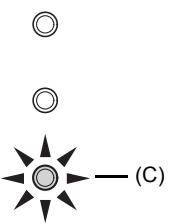
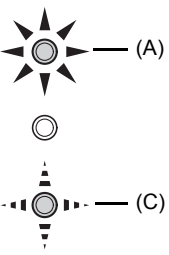
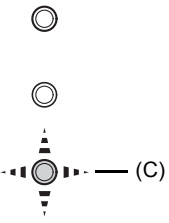
 <p>(C) The <b>Ink</b> lamp lights.</p>	<p>Ink is low. You can continue printing for a while, but we recommend you to have a new FINE Cartridge available.</p> <p>* The diagram on the left indicates the status of the Color FINE Cartridge as an example.</p>
 <p>(A) The <b>Alarm</b> lamp lights. (C) The <b>Ink</b> lamp flashes.</p>	<ul style="list-style-type: none"> <li>• If “E, 1, 6” is displayed on the LED, ink has run out. See “E, 1, 6” (Ink has run out.) in “An Error Code Is Displayed on the LED” on page 45 and take appropriate action.</li> <li>• If “E, 1, 3” is displayed on the LED, ink may have run out. See “E, 1, 3” (Ink may have run out.) in “An Error Code Is Displayed on the LED” on page 45 and take appropriate action.</li> </ul> <p>* The diagram on the left indicates the status of the Color FINE Cartridge as an example.</p>
 <p>(C) The <b>Ink</b> lamp flashes.</p>	<p>The function for detecting the remaining ink level is disabled.</p> <p>* The diagram on the left indicates the status of the Color FINE Cartridge as an example.</p>

● **With the Computer Screen**

You can confirm the status of each FINE Cartridge on the printer status monitor (Windows) and Canon IJ Printer Utility (Macintosh).

**Windows**

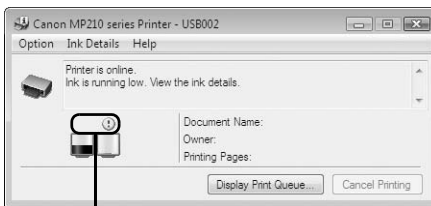

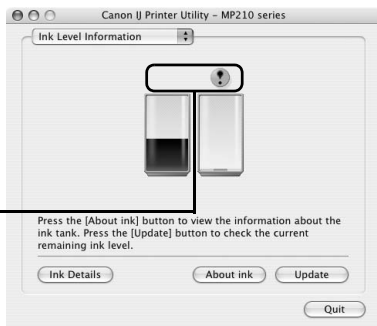

(A)

**Macintosh**



(A) Confirm whether any symbols are displayed here.

-  Ink is low. You can continue printing for a while, but we recommend you to have a new FINE Cartridge available.
-  Ink has run out. See “E, 1, 6” (Ink has run out.) in “An Error Code Is Displayed on the LED” on page 45 and take appropriate action.
-  Ink may have run out. See “E, 1, 3” (Ink may have run out.) in “An Error Code Is Displayed on the LED” on page 45 and take appropriate action.



The function for detecting the remaining ink level is disabled.

Follow the procedure below to open each of the confirmation screens.

## Windows

- 1** Open the printer properties dialog box.  
Refer to “Opening the Printer Properties Dialog Box Directly from Control Panel” in “Opening the Printer Properties Dialog Box (Windows)” of the *User’s Guide* on-screen manual.
- 2** Click **View Printer Status** on the **Maintenance** sheet.  
To confirm the FINE Cartridge information, click the **Ink Details** menu.

---

### Note

You can also display the printer status monitor by clicking **Canon XXX Printer** (where “XXX” is your machine’s name) which appears on the taskbar during printing.

---

## Macintosh

- 1** Open the Canon IJ Printer Utility.  
Refer to “Opening the Canon IJ Printer Utility (Macintosh)” in the *User’s Guide* on-screen manual.
- 2** Select **Ink Level Information** in the pop-up menu.  
To confirm the FINE Cartridge information, click **Ink Details**.

## ■ Replacing FINE Cartridges

When FINE Cartridges run out of ink, replace them using the following steps.

### ⚠ Important

#### Handling FINE Cartridges

- Do not touch the electrical contacts or Print Head Nozzles on a FINE Cartridge. The machine may not print out properly if you touch it.

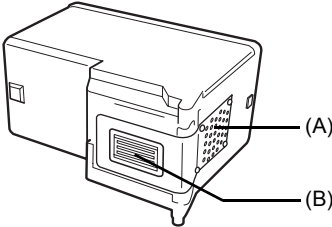

(A) Electrical Contacts  
(B) Print Head Nozzles

- To maintain optimal printing quality, we recommend the use of specified Canon brand FINE Cartridges.  
Refilling ink is not recommended.
- Once you remove a FINE Cartridge, replace it immediately. Do not leave the machine with FINE Cartridges removed.
- Replace empty cartridges with new ones. If you insert FINE Cartridges that has been removed once, the machine may not print out properly due to some reasons such as clogging of the nozzles.  
Furthermore, with such cartridges, the Low Ink Warning may not be displayed properly.
- Once a FINE Cartridge has been installed, do not remove it from the machine and leave it out in the open. This will cause the FINE Cartridge to dry out, and the machine may not operate properly when it is reinstalled. To maintain optimal printing quality, use a FINE Cartridge within six months of first use.

### 📖 Note

- If a FINE Cartridge runs out of ink, you can print with either Color or Black FINE Cartridge, in whichever ink remains, only for a while. However the print quality may be reduced compared to when printing with both cartridges. Canon recommends to use new FINE cartridges in order to obtain optimum qualities.  
Even when printing with one ink only, print with leaving the empty FINE Cartridge installed. If either of the Color FINE Cartridge or Black FINE Cartridge is not installed, an error occurs and the machine cannot print.  
For information on how to configure this setting, refer to the *PC Printing Guide* on-screen manual.
- Color ink may be consumed even when printing a black-and-white document or when black-and-white printing is specified.  
Color ink is also consumed in Print Head Cleaning and Print Head Deep Cleaning, which may be necessary to maintain the machine's performance.

- 1 Open the Paper Output Tray.
- 2 Make sure that the machine is turned on, lift the Scanning Unit (Printer Cover), then pull the Scanning Unit Support (A) down into place.

The FINE Cartridge Holder moves to the left.

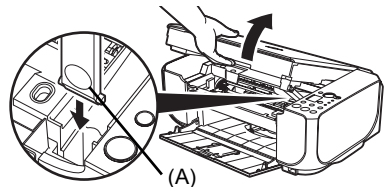



---

**⚠ Caution**

- Do not hold the FINE Cartridge Holder to stop or move it.
- Do not touch the metallic parts inside the machine.

**🚫 Important**

If the Scanning Unit (Printer Cover) is left open for more than 10 minutes, the FINE Cartridge Holder moves to the right. Close and reopen the Scanning Unit (Printer Cover) to return the holder to the left.

---

**3** Remove the empty FINE Cartridge.

- (1) Push down the FINE Cartridge.

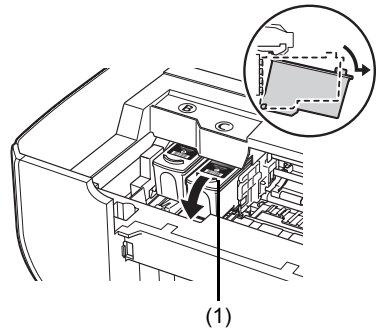

- (2) Remove the FINE Cartridge.

---

**🚫 Important**

- Handle FINE Cartridges carefully to avoid staining your clothes or the surrounding area.
  - Discard empty FINE Cartridges according to the local laws and regulations regarding disposal of consumables.
- 

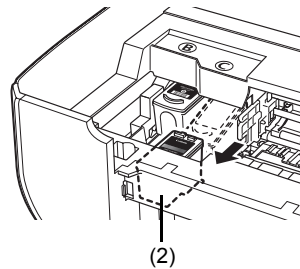

**4** Prepare the replacement FINE cartridge.

- (1) Unpack a new FINE Cartridge and remove the orange protective tape (A) gently.

---

**🚫 Important**

- Handle FINE Cartridges carefully to avoid staining your clothes or surrounding work area.
  - Do not reattach the protective tape once you have removed it. Discard it according to the local laws and regulations regarding disposal of consumables.
  - Do not touch the electrical contacts or Print Head Nozzles on a FINE Cartridge. The machine may not print out properly if you touch it.
  - Be careful not to stain your clothes and hands with ink on the removed protective tape.
- 

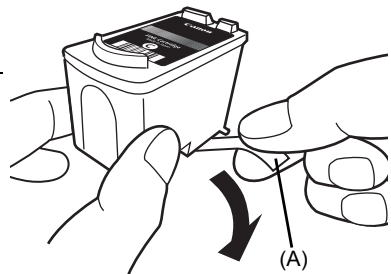

## 5 Install the FINE Cartridge.

- (1) Insert a new FINE Cartridge all the way into the appropriate slot.  
The Black FINE Cartridge should be installed into the left slot (B) and the Color FINE Cartridge should be into the right slot (C).

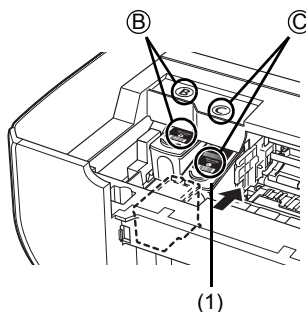

- (2) Push up the FINE Cartridge until it clicks into place.

---

### Important

The machine cannot be used unless both the FINE Cartridges are installed.

---

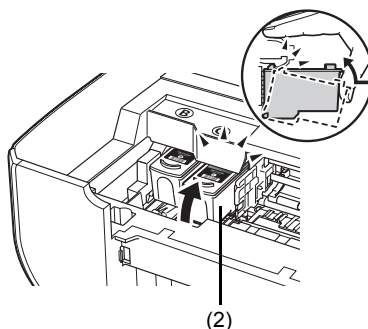

- ## 6
- Lift the Scanning Unit (Printer Cover) slightly to set the Scanning Unit Support back to its original position, and then gently close the Scanning Unit (Printer Cover).

---

### Caution

Be sure to hold the Scanning Unit (Printer Cover) firmly, and be careful not to get your fingers caught.

### Note

- If the error code is still displayed after the Scanning Unit (Printer Cover) is closed, see "An Error Code Is Displayed on the LED" on page 44.
  - If a print job has not been done yet, press the **Black** or **Color** button to resume printing.
  - When you start printing after replacing the FINE Cartridge, Print Head Cleaning is performed automatically. Do not perform any other operations until Print Head Cleaning finishes.
  - If the straight line is misaligned or the Print Head position is misaligned, align the Print Head position.  
See "Aligning the Print Head" on page 31.
-

# Keeping the Best Printing Results

---

To avoid drying of the Print Head and clogging of the nozzles, note the following.

---

## Note

- Ink may blur depending on the paper in the following cases:
    - Printed area is traced with a highlight pen or paint-stick, or
    - Printed area is stained with water or sweat.
  - If the print head nozzles get clogged, printouts will become faint or particular colors will not be printed properly. For details, see “When Printing Becomes Faint or Colors Are Incorrect” on page 26.
- 

## ■ When You Turn Off the Machine

Follow the procedure below to turn off the machine.

- (1) Press the **ON/OFF** button to turn off the machine.
- (2) Confirm that the **Power** lamp has gone out.  
This takes a few seconds or as long as around 30 seconds.
- (3) Unplug the power cord from the wall outlet.  
If you are using a power outlet strip, you can switch it off instead.

When you press the **ON/OFF** button to turn off the machine, the machine automatically puts a protective cap on the Print Head to prevent the ink from drying. If you remove the power cord or switch off the power outlet strip before the **Power** lamp goes out, this capping will not be done properly, causing the Print Head to dry and clog.

## ■ When You Are Not Using the Machine for a Long Time

When you are not using the machine for a long time, print or copy in both black & white and in color, or perform Print Head Cleaning, about once a month to prevent degradation of the Print Head.

Numerous nozzles are installed in the Print Head for high-precision printing. Just as the uncapped tip of a ballpoint pen or marker becomes dry and unusable if it is not used for a long period of time, the print head nozzles become blocked by dried ink. Periodically printing or cleaning the Print Head can prevent this blockage.

# Cleaning Your Machine

---

This section describes the cleaning procedure that is needed to maintain your machine.

---

## Caution

- Do not use tissue paper, paper towels, or similar materials for cleaning. Paper tissue powders or fine threads may remain inside the machine and cause problems such as a blocked Print Head and poor printing results. Use a soft cloth to avoid scratching the components.
  - Never use volatile liquids such as thinners, benzene, acetone, or any other chemical cleaner to clean the machine, as this may cause a malfunction or damage the machine's surface.
- 

## ■ Cleaning the Exterior of the Machine

---

### Caution

Be sure to turn off the power and disconnect the power cord before cleaning the machine.

### Important

- When cleaning the exterior of the machine, do not use tissue paper, rough-textured cloth, or similar materials, as this may scratch the surface.
  - Never use neutral detergent or volatile liquids such as thinners, benzene, acetone, or any other chemical cleaner, as this may damage the surface.
- 

Be sure to use a soft cloth such as eyeglasses cleaning cloth and wipe off dirt on the surface with it gently. Smooth out wrinkles on the cloth if necessary before cleaning.

## ■ Cleaning the Platen Glass and Document Cover

---

### Caution

Be sure to turn off the power and disconnect the power cord before cleaning the machine.

### Important

The inner side of the Document Cover (white sheet) (B) is easily damaged, so wipe it gently.

---

With a clean, soft, lint-free cloth, wipe the Platen Glass (A) and the inner side of the Document Cover (white sheet) (B) gently. Make sure not to leave any residue, especially on the Platen Glass.

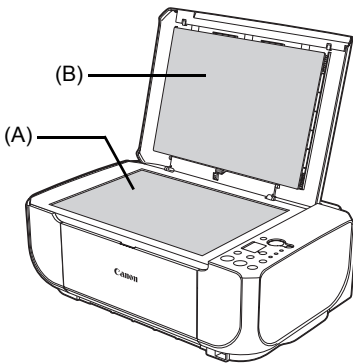

## ■ Cleaning the Paper Feed Roller (Roller Cleaning)

Clean the paper feed roller if paper is not fed properly. Cleaning the paper feed roller will wear the roller, so perform this only when necessary.

**1** Make sure that the machine is turned on, and then remove any paper from the Rear Tray.

**2** Clean the paper feed roller.

(1) Press the **Maintenance** button repeatedly until **b** appears.

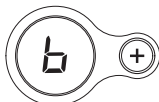

(2) Press the **Black** or **Color** button.  
The Paper Feed Roller will rotate as it is cleaned.

**3** Repeat step 2 twice.

**4** Open the Paper Output Tray, then open the Output Tray Extension.

**5** Make sure that the paper feed roller stops rotating, then load three or more sheets of A4 or Letter-sized plain paper in portrait orientation in the Rear Tray.

Set the Paper Thickness Lever to the left. For details on the Paper Thickness Lever, refer to "Inside" in "Main Components" of the *User's Guide* on-screen manual.

**6** Repeat step 2 three times.

The paper cleans the paper feed roller as it feeds through the machine.

If the problem is not resolved, wipe the paper feed roller (A) located on the right side inside the Rear Tray with a moistened cotton swab or the like. Rotate the roller (A) manually as you clean it. Do not touch the roller with your fingers; rotate it with the cotton swab. If this does not solve the problem, contact your Canon service representative.

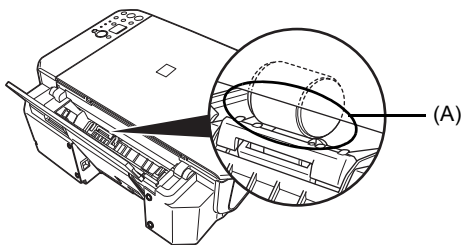

## ■ Cleaning the Inside of the Machine (Bottom Plate Cleaning)

This section describes how to clean the inside of the machine. If the inside of the machine becomes dirty, printed paper may get dirty, so we recommend performing cleaning regularly.

---

### ● Important

Do not perform any other operation while the bottom plate is being cleaned.

---

**1** Make sure that the machine is turned on, and then remove any paper from the Rear Tray.

- 2 Open the Paper Output Tray, then open the Output Tray Extension.
- 3 Fold a single sheet of A4 or Letter-sized plain paper in half widthwise, and then unfold the paper.
- 4 Load this and only this sheet of paper in the Rear Tray with the open side to the front.

Set the Paper Thickness Lever to the left. For details on the Paper Thickness Lever, refer to "Inside" in "Main Components" of the *User's Guide* on-screen manual.

- 5 Perform bottom plate cleaning.

- (1) Press the **Maintenance** button repeatedly until **J** appears.



- (2) Press the **Black** or **Color** button.

The paper cleans the inside of the machine as it feeds through the machine.

Check the folded part of the ejected paper. If it is smudged with ink, perform Bottom Plate Cleaning again.

If the problem is not resolved after performing Bottom Plate Cleaning twice, the protrusions inside the machine may be stained. Clean them according to instructions. See "Cleaning the Protrusions Inside the Machine" on page 42.

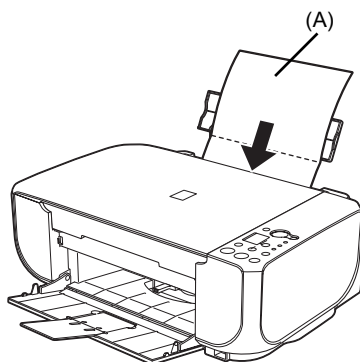

(A) Load the paper after unfolding it.

---

#### **Note**

When performing Bottom Plate Cleaning again, make sure to use a new piece of paper.

---

### ■ **Cleaning the Protrusions Inside the Machine**

If protrusions inside the machine are stained, wipe off any ink from the protrusions using a cotton swab or the like.

---

#### **Caution**

Be sure to turn off the power and disconnect the power cord before cleaning the machine.

---

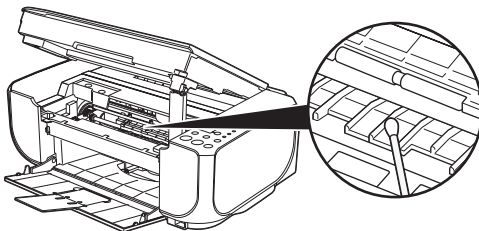

# Troubleshooting

This section describes troubleshooting tips for problems you may encounter when using the machine.

---

## Note

This section mainly describes the methods of machine operation for troubleshooting. To handle problems using your computer, refer to "Troubleshooting" in the *User's Guide* on-screen manual. For details on how to view the on-screen manuals, see "Reading the On-screen Manuals" on page 60.

---

- "An Error Code Is Displayed on the LED" on page 44
- "LED Cannot Be Seen At All" on page 46
- "Cannot Install the MP Drivers" on page 46
- "Cannot Connect to Computer Properly" on page 47
- "Print Results Not Satisfactory" on page 48
- "The Print Result Not Satisfactory When Copying" on page 52
- "Printing Does Not Start" on page 52
- "Paper Does Not Feed Properly" on page 53
- "Paper Jams" on page 54
- "Error Message Appears on the Computer Screen" on page 55
- "Error Message Appears on a PictBridge Compliant Device" on page 57
- "Scanning Problems" on page 58

## Windows

### If an Error Occurs When the Machine Is Connected to a Computer

When an error occurs in printing such as the machine is out of paper or paper is jammed, a troubleshooting message is displayed automatically. Take the appropriate action described in the message.

The message may vary depending on the version of your Windows operating system.

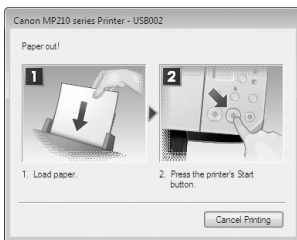

# An Error Code Is Displayed on the LED

If an error code is displayed on the LED, take the corresponding action described below.

## ■ Alarm Lamp is lit Orange

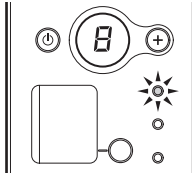

When a printer error occurs, the **Alarm** lamp is lit orange. The number displayed on the LED indicates the type of error that has occurred. Check the error code displayed on the LED and take the appropriate action to correct the error.

**E** and number (error code) are alternately displayed on the LED.

Error Code	Cause	Action
E, 2	The machine is out of paper. / Paper does not feed.	Reload the paper correctly and press the <b>Black</b> or <b>Color</b> button.
E, 3	Paper jam.	If paper has jammed in the machine, clear the jam, reload the paper in the machine correctly and then press the <b>Black</b> or <b>Color</b> button.
E, 4/ E, 5	The FINE Cartridge cannot be recognized.	The FINE Cartridge may not be installed properly, or the Cartridge may not be compatible with this machine. Open the Scanning Unit (Printer Cover) and install the appropriate FINE Cartridge. If the error is not resolved, the Print Head may be damaged. Contact your Canon Service representative.
E, 7	FINE Cartridge is not installed in the correct position.	Make sure that each FINE Cartridge is installed in the correct position. See "Replacing a FINE Cartridge" on page 33.
E, 8	Ink absorber is almost full.	The machine has a built-in ink absorber to hold the ink used during Print Head Cleaning, for example. This error code indicates that the ink absorber is nearly full. Press the <b>Black</b> or <b>Color</b> button to cancel the error so you can continue printing. However, because printing is disabled once the ink absorber becomes completely full and until the ink absorber is replaced, you are recommended to contact your Canon service representative as early as possible. (You will need to replace a particular part of the machine.)
E, 9	The digital camera or digital video camcorder connected is not compatible with this machine.	A communication time out occurs if an operation takes too long or if it takes too much time to send data. This may cancel printing. In such cases, disconnect and reconnect the USB cable. When printing from a PictBridge compliant device, depending on the model or brand of your device, you may have to select a PictBridge compliant print mode on the device before connecting it to the machine. You may also have to turn on your device or select Play mode manually after connecting the device to the machine. Perform necessary operations before connecting your device referring to its instruction manual. If the error is still not resolved, check if you can print another photograph.



Error Code	Cause	Action
E, 1, 3	Ink level cannot be detected.	Ink may have run out. The function for detecting the remaining ink level will be disabled since the ink level cannot be correctly detected. If you want to continue printing without this function, press the <b>Stop/Reset</b> button for at least 5 seconds. Canon recommends to use new genuine Canon cartridges in order to obtain optimum qualities. Please be advised that Canon shall not be liable for any malfunction or trouble caused by continuation of printing under the ink out condition.
E, 1, 4	The FINE Cartridge cannot be recognized.	The FINE Cartridge may not be compatible with this machine. Install the appropriate FINE Cartridge. See "Replacing a FINE Cartridge" on page 33.
E, 1, 5	The FINE Cartridge cannot be recognized.	The FINE Cartridge may not be installed properly. Open the Scanning Unit (Printer Cover) and install the FINE Cartridge properly. If the error is not resolved, the FINE Cartridge may be damaged. Contact your Canon Service representative.
E, 1, 6	Ink has run out.	Ink has run out. Replace the ink cartridge and close the Scanning Unit (Printer Cover). If printing is in progress and you want to continue printing, press the <b>Stop/Reset</b> button for at least 5 seconds with the ink cartridge installed. Then printing can continue under the ink out condition. The function for detecting the remaining ink level will be disabled. Replace the empty ink cartridge immediately after the printing. The resulting print quality is not satisfactory, if printing is continued under the ink out condition.
E, 1, 9	PictBridge compliant device is connected via a USB hub.	If a PictBridge compliant device is connected via a USB hub, remove the hub and connect it directly to the machine.
E, 2, 0	The size of the document cannot be correctly detected or the document is too small when the Fit-to-Page copying is selected. / Scanning the Print Head Alignment Sheet has failed.	<ul style="list-style-type: none"> <li>The size of the document cannot be correctly detected or the document is too small when the Fit-to-Page copying is selected. Make sure the document meets the requirements and correctly loaded on the Platen Glass. Then reload the document and press the <b>Black</b> or <b>Color</b> button. See "Loading Original Documents" on page 6.</li> <li>Scanning the Print Head Alignment Sheet has failed. Make sure all required boxes on the head alignment sheet are filled in, and that the sheet is set in the correct position and orientation on the Platen Glass. If the error is not resolved, connect the machine to the computer and align the Print Head on the printer driver. For details, refer to "Aligning Print Head on the Computer" in the <i>User's Guide</i> on-screen manual.</li> </ul>

## ■ Power Lamp Flashes Green and Alarm Lamp Flashes Orange Alternately

The **Power** and **Alarm** lamps flash alternately as shown below.

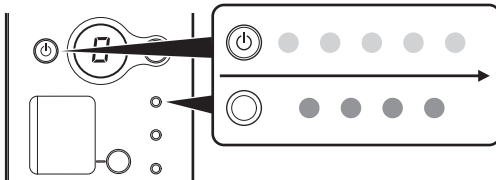

Disconnect the USB cable from the machine, turn the machine off, and then unplug the machine from the power supply. Plug the machine back in and turn the machine back on after leaving it for a while.

If the problem is not resolved, contact your Canon Service representative.





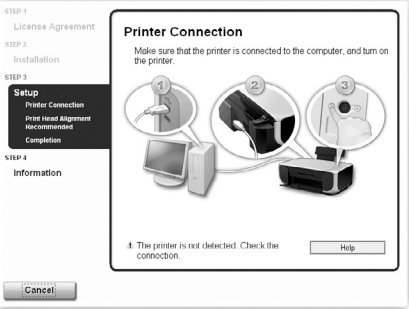

Error Code	Cause	Action
E, 2, x E, 3, x E, 4, x	An error requiring servicing might have occurred.	Make sure that the protective material is removed from the FINE Cartridge Holder, then turn the machine off and unplug the power cord of the machine from the power supply. After a while, plug the power cord of the machine back in, and then turn on the machine. If the same error occurs, contact your Canon service representative.

## LED Cannot Be Seen At All

Cause	Action
The machine is not powered on or the LED is in the screen-saver mode.	<ul style="list-style-type: none"> <li>If the <b>Power</b> lamp is off The machine is not powered on. Connect the power cord and press the <b>ON/OFF</b> button. The machine will power on and the LED will light.</li> <li>If the <b>Power</b> lamp is lit The LED may be in the screen-saver mode. On the Operation Panel, press a button other than the <b>ON/OFF</b> button.</li> </ul>

## Cannot Install the MP Drivers

Cause	Action
<p><b>Windows</b></p> <p>Unable to proceed beyond the <b>Printer Connection</b> screen.</p>	<p>If you were unable to proceed beyond the <b>Printer Connection</b> screen, follow the procedure below to reinstall the MP Drivers.</p>  <ol style="list-style-type: none"> <li>Click <b>Cancel</b> on the <b>Printer Connection</b> screen.</li> <li>Click <b>Start Over</b> on the <b>Installation Failure</b> screen.</li> <li>Click <b>Back</b> on the screen that appears next.</li> <li>Click <b>Exit</b> on the <b>PIXMA XXX</b> screen (where “XXX” is your machine’s name), then remove the CD-ROM.</li> <li>Turn the machine off.</li> <li>Restart your computer.</li> <li>Make sure you have no application software running, including anti-virus software.</li> <li>Follow the procedure described in your setup sheet to reinstall the MP Drivers.</li> </ol>

Cause	Action
<p>Installation does not start automatically when the <i>Setup CD-ROM</i> is inserted into your computer's disc drive.</p>	<p> <b>Windows</b></p> <p>(1) Click <b>Start</b> then <b>Computer</b>.  In Windows XP, Click <b>Start</b> then <b>My Computer</b>.  In Windows 2000, double-click the <b>My Computer</b> icon on the desktop.</p> <p>(2) Double-click the CD-ROM icon  on the displayed window.</p> <p> <b>Note</b></p> <p>To use the <b>Run</b> command to start the setup program, specify your disc drive and then the name of the setup program, <b>MSETUP4.EXE</b>. The drive letter of the disc drive depends on your computer.</p> <p> <b>Macintosh</b></p> <p>Double-click the CD-ROM icon on your desktop to start installation.</p> <p>If the CD-ROM icon is not displayed, restart your computer.  If the CD-ROM icon is still not displayed, try different disks and see if they are displayed. If other disks are displayed, there is a problem with the <i>Setup CD-ROM</i>. Contact your Canon service representative.</p>
<p>Installation procedure not followed correctly.</p>	<p>Follow the procedure described in your setup sheet for proper installation.  If the MP Drivers were not installed correctly, uninstall the MP Drivers, restart your computer, and then reinstall the MP Drivers. Refer to the <i>PC Printing Guide</i> on-screen manual.</p> <p> <b>Windows</b></p> <p> <b>Note</b></p> <p>If the installer was forced to be terminated due to a Windows error, the system may be in an unstable condition and you may not be able to install the MP Drivers. Restart your computer before reinstalling.</p>

## Cannot Connect to Computer Properly

### ■ Printing Speed Is Slow / USB 2.0 Hi-Speed Connection Does Not Work

Cause	Action
<p>Your system environment is not fully compatible with USB 2.0 Hi-Speed.</p>	<p>If your system environment is not fully compatible with USB 2.0 Hi-Speed, the machine will operate at a lower speed provided under USB 1.1. In this case, the machine operates properly but printing speed may slow down due to communication speed.</p> <p>Check the following to ensure that your system environment supports USB 2.0 Hi-Speed connection.</p> <ul style="list-style-type: none"> <li>● The USB port on your computer supports USB 2.0 Hi-Speed connection.</li> <li>● The USB cable, and the USB hub if you are using one, support USB 2.0 Hi-Speed connection.  Be sure to use a certified USB 2.0 Hi-Speed cable. We recommend the cable to be no longer than around 10 feet / 3 meters.</li> <li>● The operating system of your computer supports USB 2.0 Hi-Speed connection.  Obtain and install the latest update for your computer.</li> <li>● The USB 2.0 Hi-Speed driver operates properly.  Obtain the latest version of the USB 2.0 Hi-Speed driver compatible with your hardware and install it on your computer.</li> </ul> <p> <b>Important</b></p> <p>For details on USB 2.0 Hi-Speed of your system environment, contact the manufacturer of your computer, USB cable, or USB hub.</p>

## ■ “This device can perform faster” Message Is Displayed

Cause	Action
Your system environment is not fully compatible with USB 2.0 Hi-Speed.	Your system environment is not compatible with USB 2.0. See “Printing Speed Is Slow / USB 2.0 Hi-Speed Connection Does Not Work” on page 47.

## Print Results Not Satisfactory

If the print result is not satisfactory, confirm the paper and print quality settings first.

### ● Do the page size and media type settings match the size and type of the loaded paper?

When these settings are incorrect, you cannot obtain a proper print result. If you are printing a photograph or an illustration, incorrect paper type setting may reduce the quality of printout color. Also, if you print with an incorrect paper type setting, the printed surface may be scratched. In borderless printing, uneven coloring may occur depending on the combination of the paper type setting and the loaded paper.

### ● Did you set the print quality setting appropriately?

Select a print quality option suitable to the paper and image for printing. If you notice blurs or uneven colors, increase the print quality setting and try printing again.

The method to confirm the paper and print quality settings differs depending on what you do with your machine.

To copy by operating the machine	Confirm by using the Operation Panel on the machine. Refer to the <i>User's Guide</i> on-screen manual.
To print from a PictBridge compliant device	Confirm by using your PictBridge compliant device or the Operation Panel on the machine. You can only specify the page size and media type settings on the machine. See “Printing Photographs Directly from a Compliant Device” on page 20.
To print from a computer	Confirm by using the printer driver. Refer to the <i>PC Printing Guide</i> on-screen manual.

If the problem is not resolved even if the paper and print quality settings are correct, there may be other causes. See also the sections below.

## ■ Colors Are Unclear

Cause	Action
Color correction is not enabled.	When printing photographs or other graphics, enabling color correction may improve color. When printing from your computer, refer to “Print Results Not Satisfactory” in the <i>User's Guide</i> on-screen manual.

**■ Printing Does Not Start/Printing Is Blurred/Colors Are Wrong/Straight Lines Are Misaligned**

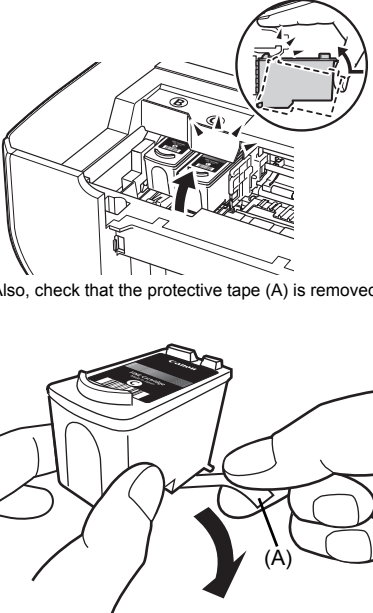
Cause	Action
<p>FINE Cartridge is not installed properly / There is no ink left.</p>	<p>Remove the FINE Cartridge, then reinstall it. Small dusts may be stuck between the contact points. In this case, the print result may be improved by reinstalling the FINE Cartridge.</p>  <p>Also, check that the protective tape (A) is removed.</p>
<p>Print Head nozzles are clogged.</p>	<p>See "When Printing Becomes Faint or Colors Are Incorrect" on page 26 and perform any necessary maintenance operation.</p>
<p>The media is loaded with the wrong side facing upwards.</p>	<p>Many types of paper are made to be printed on only a particular side of the paper. Printing on the wrong side may cause unclear prints or prints with reduced quality. For detailed information on the printable side, refer to the instruction manuals supplied with the paper.</p>
<p>Print Head is misaligned.</p>	<p>If you did not align the Print Head after installation, straight lines may be printed misaligned. Make sure to align the Print Head after you install it. See "Aligning the Print Head" on page 31 to perform Automatic Print Head Alignment.</p>

**■ White Streaks**

Cause	Action
<p>Print Head nozzles are clogged.</p>	<p>See "When Printing Becomes Faint or Colors Are Incorrect" on page 26 and perform any necessary maintenance operation.</p>

## ■ Printed Paper Curls or Has Ink Blots

Cause	Action
Paper is too thin.	When printing data with high color saturation such as photographs or images in deep color, we recommend using Photo Paper Pro or other Canon specialty paper. See "Media Types You Cannot Use" on page 9.

## ■ Printed Surface Is Scratched/Paper Is Smudged

Cause	Action
Paper Feed Roller is dirty.	Clean the Paper Feed Rollers. Cleaning the Paper Feed Rollers will wear the rollers, so perform this procedure only when necessary. For details on cleaning, see "Cleaning the Paper Feed Roller (Roller Cleaning)" on page 41.
Inside of the machine is dirty.	When performing duplex printing, if the specified page size does not match the actual size of paper loaded in the paper source, the inside will become stained with ink, causing printed paper to become smudged. Perform the Bottom Plate Cleaning to clean the inside of the machine. For details on cleaning, see "Cleaning the Inside of the Machine (Bottom Plate Cleaning)" on page 41.  <b>Note</b> To prevent the inside of the machine from getting stained, set the page size correctly.
Printing on inappropriate type of paper.	<ul style="list-style-type: none"> <li>● Check to see if the paper you are printing on is not too thick or curled. See "Media Types You Cannot Use" on page 9.</li> <li>● When performing Borderless Printing, print quality may be reduced at the top and bottom edges of the paper. Make sure that the paper you are using is suitable for Borderless Printing. For details, refer to "Printing Area" in the <i>User's Guide</i> on-screen manual.</li> </ul>

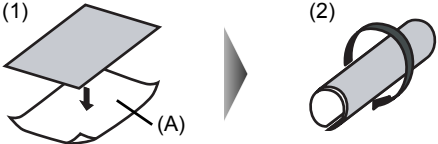
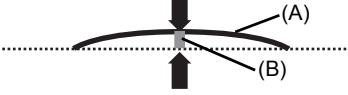
Cause	Action
Paper is curled.	<p><b>For Plain Paper</b></p> <p>Turn the paper over and reload it to print on the other side.</p> <p>Leaving the paper loaded in the Rear Tray for a long time may cause the paper to curl. If this happens, load the paper with the other side facing up. It may resolve the problem.</p> <p>We recommend putting unused paper back into the package and keep them on a level surface.</p> <p><b>For Other Paper</b></p> <p>If you are using paper with either any of the corners or the whole printing surface curled, the paper may become dirty, not feed properly, or both. Use such paper after correcting paper curl as follows.</p> <p>(1) With the printing side (A) facing up, cover the paper with a fresh sheet of plain paper to avoid staining or scratching the surface.</p> <p>(2) Roll up the paper in a direction opposite to paper curl as seen below.</p>  <p>(3) Check to see that the paper curl is within approximately 0.08 to 0.2 inches / 2 to 5 mm (B) in height.</p>  <p>We recommend printing curl-corrected paper one sheet at a time.</p> <p><b>Note</b></p> <p>Depending on the media type, the paper may be smudged or may not be fed properly even if it is not curled.</p> <p>In such case, follow the procedure described above in "For Other Paper" to curl the paper before printing.</p> <p>This may improve the print result.</p>
Inappropriate Paper Thickness Lever setting.	<p>Adjust the position of the Paper Thickness Lever according to the type of paper you are printing on.</p> <p>See "Paper Handling" on page 8.</p> <p>Depending on the printing content, the printing surface may become scratched even for the types of paper to set the lever to the left. In this case, set the Paper Thickness Lever to the right.</p> <p>* Reset the Paper Thickness Lever to the left when you finish printing. If the lever is not set back to the left, the inside of the machine is more likely to get dirty due to the wider clearance between the print head and the loaded paper. It may also reduce print quality.</p> <p><b>Note</b></p> <p>If the corners or edges of the paper are smudged, try to print with the Paper Thickness Lever set to the right.</p>
Printing graphics with the intensity setting set too high.	<p>Especially if you are using plain paper to print images with high intensity, the paper may absorb too much ink and become wavy, causing paper abrasion.</p> <p>When printing from your computer, refer to "Print Results Not Satisfactory" in the <i>User's Guide</i> on-screen manual.</p>
Printing beyond the recommended printing area.	<p>If you are printing beyond the recommended printing area of your printing paper, the lower edge of the paper may become stained with ink.</p> <p>Resize your original document in your application software.</p> <p>For details on recommended printing area, refer to "Printing Area" in the <i>User's Guide</i> on-screen manual.</p>

## ■ Colors Are Uneven or Streaked

Cause	Action
Print Head nozzles are clogged.	See "When Printing Becomes Faint or Colors Are Incorrect" on page 26 and perform any necessary maintenance operations.
Print Head is misaligned.	See "Aligning the Print Head" on page 31 to perform Automatic Print Head Alignment.

## The Print Result Not Satisfactory When Copying

Cause	Action
The original document is not loaded correctly.	Check that the original is loaded correctly on the Platen Glass. See "Loading Original Documents" on page 6.
The original document is not loaded with the side to be copied faced down.	When loading the original on the Platen Glass, the side to be copied should be faced down.
The original document is a printout from this machine.	Print quality may be reduced if you copy a printout. Instead of copying a printout, print the original directly either from the digital camera, or your computer.
The Platen Glass or the inner side of the Document Cover is dirty.	Clean the Platen Glass and the inner side of the Document Cover. See "Cleaning the Platen Glass and Document Cover" on page 40.

If these do not resolve the problem, also see "Print Results Not Satisfactory" on page 48.

## Printing Does Not Start

Cause	Action
Unnecessary print jobs are left in queue. / Computer problems.	<p>Restarting your computer may solve the problem. If there are any unnecessary print jobs, follow the procedure below to delete them.</p> <p><b>Windows</b></p> <ol style="list-style-type: none"> <li>Open the printer properties dialog box. Refer to "Opening the Printer Properties Dialog Box Directly from Control Panel" in "Opening the Printer Properties Dialog Box (Windows)" of the <i>User's Guide</i> on-screen manual.</li> <li>Click the <b>Maintenance</b> tab and then <b>View Printer Status</b>. The printer status monitor is displayed.</li> <li>Click <b>Display Print Queue</b>.</li> <li>Select <b>Cancel All Documents</b> on the <b>Printer</b> menu. You may not be able to select this depending on the privileges of the account.</li> <li>When the confirmation message is displayed, click <b>Yes</b>. The print jobs are deleted.</li> </ol> <p><b>Macintosh</b></p> <ol style="list-style-type: none"> <li>Click the printer icon in the Dock to display the list of print jobs in progress. In Mac OS X v.10.2.8, click the printer icon in the Dock to start up the <b>Print Center</b> and double-click the name of your machine in the <b>Printer List</b>.</li> <li>Select the print job to delete and click . The print jobs are deleted.</li> </ol>



Cause	Action
The machine is not ready.	<p>Check if the <b>Power</b> lamp is lit green.</p> <p>If the <b>Power</b> lamp is off, turn the machine on.</p> <p>While the <b>Power</b> lamp is flashing green, the machine is initializing. Wait until the <b>Power</b> lamp stops flashing and remains lit green.</p> <p> <b>Note</b></p> <p>When printing large data such as a photo or graphics, it may take longer to start printing.</p>

## Paper Does Not Feed Properly

Cause	Action
Printing on inappropriate type of paper.	<p>Check to see if the paper you are printing on is not too thick or curled.</p> <p>See "Media Types You Cannot Use" on page 9.</p>
Paper Feed Rollers are dirty.	<p>Clean the Paper Feed Rollers. Cleaning the Paper Feed Rollers will wear the rollers, so perform this procedure only when necessary.</p> <p>For details on cleaning, see "Cleaning the Paper Feed Roller (Roller Cleaning)" on page 41.</p>
Paper not loaded properly.	<p>Make sure of the following when you load paper in the machine.</p> <ul style="list-style-type: none"> <li>● When loading two or more sheets of paper, align the edges of the sheets before loading.</li> <li>● Always load the paper in portrait orientation in the Rear Tray, regardless of the printing orientation.</li> <li>● Load the paper with the print side facing UP. Align the paper stack against the right side of the Rear Tray and slide the Paper Guide so that it just touches the left edge of the stack.</li> </ul> <p>For details on loading paper, see "Loading Paper" on page 10.</p>
Too much paper loaded.	<p>Make sure that the paper stack does not exceed the load limit. However, proper feeding of paper may not be possible at this maximum capacity depending on the type of paper or environmental conditions (either very high or low temperature and humidity).</p> <p>In such cases, reduce the sheets of paper you load at a time to around half.</p> <p>For details on loading paper, see "Loading Paper" on page 10.</p>
Foreign object in the Rear Tray.	<p>Make sure that there are no foreign objects in the Rear Tray.</p>
Envelopes not prepared nor loaded properly.	<ul style="list-style-type: none"> <li>● When printing on envelopes, see "Loading Envelopes" on page 12, and prepare the envelopes before printing.</li> </ul> <p>Once you have prepared the envelopes, load them in the machine in portrait orientation. If the envelopes are placed in landscape orientation, they will not feed properly.</p> <ul style="list-style-type: none"> <li>● Set the Paper Thickness Lever to the right.</li> </ul>

# Paper Jams

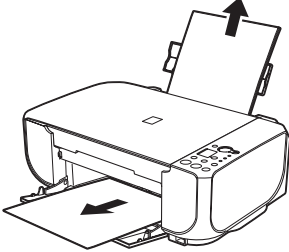
Cause	Action
<p>Paper jammed in the Paper Output Slot or the Rear Tray.</p>	<p>Remove the paper following the procedure below.</p> <p>(1) Slowly pull the paper out, either from the Rear Tray or from the Paper Output Slot, whichever is easier.</p>  <p>● If the paper tears and a piece remains inside the machine, turn the machine off, open the Scanning Unit (Printer Cover) and remove it. Be careful not to touch the components inside the machine. After removing all paper, close the Scanning Unit (Printer Cover), and turn it back on.</p> <p>● If you cannot pull the paper out, turn the machine off and turn it back on. The paper will be ejected automatically.</p> <p>(2) Reload the paper in the machine, and press the <b>Black or Color</b> button on the machine.</p> <p>If you turned off the machine in step 1, all print jobs in queue are canceled. Reprint if necessary.</p> <p><b>Note</b></p> <ul style="list-style-type: none"> <li>● For details on how to load paper, see "Loading Printing Paper" on page 7.</li> <li>● When reloading the paper in the machine, see "Paper Does Not Feed Properly" on page 53 to confirm that you are using the correct paper and are loading it into the machine correctly.</li> </ul> <p>If you cannot remove the paper or the paper tears inside the machine, or if the paper jam error continues after removing the paper, contact your Canon Service representative.</p>
<p>Landscape credit card-sized paper jammed inside the machine.</p>	<p>Do not load credit card-sized paper in landscape orientation. Slowly pull out the paper from the Rear Tray and remove it. If you cannot remove the jammed paper or the paper jam error continues after removing the paper, contact your Canon Service representative.</p>

# Error Message Appears on the Computer Screen



## ■ Writing Error/Output Error/Communication Error

Cause	Action
The machine is not ready.	<p>Confirm that the <b>Power</b> lamp is lit green.</p> <p>If the <b>Power</b> lamp is off, turn the machine on.</p> <p>While the <b>Power</b> lamp is flashing green, the machine is initializing. Wait until the <b>Power</b> lamp stops flashing and remains lit green.</p> <p>If the <b>Alarm</b> lamp is lit orange, an error may have occurred on the machine. For details on how to resolve the error, see "An Error Code Is Displayed on the LED" on page 44.</p>
Printer port setting does not match the computer's interface connecting the machine.	<p>Check the printer port settings.</p> <p>* In the following instruction, "<b>XXX</b>" signifies your machine's name.</p> <p><b>(1)</b> Log into a user account with the administrator privilege.</p> <p><b>(2)</b> Click <b>Control Panel</b>, then <b>Printer</b> under <b>Hardware and Sound</b>.            In Windows XP, click <b>Control Panel, Printers and Other Hardware</b>, then <b>Printers and Faxes</b>.            In Windows 2000, click <b>Control Panel</b> then <b>Printers</b>.</p> <p><b>(3)</b> Click the <b>Canon XXX Printer</b> icon.</p> <p><b>(4)</b> Select <b>Set printer properties</b> on the command bar.            In non-Vista Windows, open the <b>File</b> menu then select <b>Properties</b>.</p> <p><b>(5)</b> Click the <b>Ports</b> tab to confirm the port settings.            Make sure that a port named <b>USBnnn</b> (where "n" is a number) with <b>Canon XXX Printer</b> appearing in the <b>Printer</b> column is selected for <b>Print to the following port(s)</b>.            If the port setting is not correct, reinstall the MP Drivers or change the port setting according to the interface you are using.</p>
The machine is not connected properly.	<p>Make sure that the USB cable is securely plugged in to the machine and the computer.</p> <ul style="list-style-type: none"> <li>● If you are using a relay device such as a USB hub, disconnect it, connect the machine directly to the computer, and try printing again. If printing starts normally, there is a problem with the relay device.            Consult the reseller of the relay device for details.</li> <li>● There could also be a problem with the USB cable. Replace the USB cable and try printing again.</li> </ul>
MP Drivers are not installed properly.	<p>The MP Drivers may not be installed properly. Uninstall them following the procedure described in the <i>PC Printing Guide</i> on-screen manual and reinstall them following the procedure described in your setup sheet.</p>



## ■ Error No.: 300 Is Displayed

Cause	Action
The machine is not ready.	<p>Confirm that the <b>Power</b> lamp is lit green.</p> <p>If the <b>Power</b> lamp is off, turn the machine on.</p> <p>While the <b>Power</b> lamp is flashing green, the machine is initializing. Wait until the <b>Power</b> lamp stops flashing and remains lit green.</p> <p>If the <b>Alarm</b> lamp is lit orange, an error may have occurred on the machine. For details on how to resolve the error, see "An Error Code Is Displayed on the LED" on page 44.</p>

Cause	Action
Machine is not connected properly.	<p>Make sure that the USB cable is securely plugged in to the machine and the computer.</p> <ul style="list-style-type: none"> <li>● If you are using a relay device such as a USB hub, disconnect it, connect the machine directly to the computer, and try printing again. If printing starts normally, there is a problem with the relay device. Consult the reseller of the relay device for details.</li> <li>● There could also be a problem with the USB cable. Replace the USB cable and try printing again.</li> </ul>
Your machine is not selected in <b>Printer</b> on the <b>Print</b> dialog box.	<p>Select your machine's name in <b>Printer</b> on the <b>Print</b> dialog box.</p> <p>If your machine's name does not appear in <b>Printer</b>, follow the procedure below to check that the driver for your machine is installed to your computer.</p> <p><b>(1) Select <b>Print &amp; Fax Preferences</b> in <b>Printer</b>.</b></p> <p>In Mac OS X v.10.2.8 or 10.3.x, select <b>Edit Printer List</b> in <b>Printer</b>.</p> <p><b>(2) Check that your machine's name is displayed in the list of printers and that the check box is selected.</b></p> <p>In Mac OS X v.10.2.8, check that your machine's name is displayed in <b>Printer List</b>.</p> <p><b>(3) If your machine's name is not displayed, click <b>Add(+)</b> to add the machine.</b></p> <p>If you cannot add the machine, follow the procedure described in your setup sheet to reinstall the MP Drivers.</p>

## Macintosh

### ■ Error No.: 1700/1710 Is Displayed

Cause	Action
The ink absorber is almost full.	See "E, 8" (Ink absorber is almost full.) in "An Error Code Is Displayed on the LED" on page 44.

## Macintosh

### ■ Error No.: 2001 Is Displayed

Cause	Action
No response from connected digital camera or video camcorder. / Connected digital camera or video camcorder is not compatible with this machine.	See "E, 9" (The digital camera or digital video camcorder connected is not compatible with this machine.) in "An Error Code Is Displayed on the LED" on page 44.

## Macintosh

### ■ Error No.: 2002 Is Displayed

Cause	Action
PictBridge compliant device is connected via a USB hub.	See "E, 1, 9" (PictBridge compliant device is connected via a USB hub.) in "An Error Code Is Displayed on the LED" on page 45.

# Error Message Appears on a PictBridge Compliant Device

The following are the possible errors that may occur when printing directly from a PictBridge compliant device and the countermeasures to clear them.

## Note

- This section describes errors that are indicated on Canon-brand PictBridge compliant devices. The error messages and operations may vary depending on the device you are using. For errors on non-Canon PictBridge compliant devices, check the error code on the LED and take the appropriate action to clear the error. For details, see “An Error Code Is Displayed on the LED” on page 44.
- For the errors indicated on the PictBridge compliant device and their solution, also refer to the instruction manual of the device. For other troubles on the device, contact the manufacturer.

Error Message On PictBridge Compliant Device	Action
“Printer in use”	If the machine is printing from the computer or warming up, wait until the job ends. When it is ready, the machine starts printing automatically.
“No paper”	Load paper in the Rear Tray, and select <b>Continue*</b> in the display on your PictBridge compliant device. * To resume printing, you can also press the <b>Black</b> or <b>Color</b> button on the machine instead of selecting <b>Continue</b> on the camera.
“Paper jam”	Select <b>Stop</b> in the display on your PictBridge compliant device to stop printing. Remove the jammed paper, load new paper, press the <b>Black</b> or <b>Color</b> button on the machine, and try printing again.
“Printer cover open”	Close the Scanning Unit (Printer Cover) on the machine.
“No print head”	The FINE Cartridge is not installed or the Cartridge may not be compatible with this machine. For details on how to resolve the error, see “E, 4/E, 5” (The FINE Cartridge cannot be recognized.) in “An Error Code Is Displayed on the LED” on page 44.
“Waste tank full”/ “Ink absorber full”	The ink absorber is nearly full. For details on how to resolve the error, see “E, 8” (Ink absorber is almost full.) in “An Error Code Is Displayed on the LED” on page 44.
“No ink”/ “Ink cassette error”	<ul style="list-style-type: none"> <li>• The FINE Cartridge has or may have run out of ink.</li> <li>• The FINE Cartridge may not be installed properly or may not be compatible with this machine.</li> </ul> Check the error code on the LED and take the appropriate action to resolve the error. See “An Error Code Is Displayed on the LED” on page 44.
“Hardware Error”	FINE Cartridge errors have occurred. Replace the FINE Cartridge. See “Replacing a FINE Cartridge” on page 33.
“Printer error”	An error requiring servicing may have occurred. (Machine <b>Power</b> lamp flashes green and <b>Alarm</b> lamp flashes orange alternately.) Disconnect the USB cable between the machine and the PictBridge compliant device, turn off the machine, and unplug the power cord of the machine from the power supply. After a while, plug the power cord of the machine back in, turn on the machine, and then reconnect the PictBridge compliant device to the machine. If the same error occurs, contact your Canon Service representative.

# Scanning Problems

---

## ■ ScanGear Won't Start

Cause	Action
The scanner driver (ScanGear) is not installed.	Follow the procedure described in your setup sheet to reinstall the MP Drivers.

## ■ Other Scanning Troubles

Refer to the *Scanning Guide* on-screen manual.

# Appendix

## How to Use the Documentation Provided

---

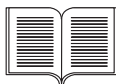

### **Printed Documentation**

#### **Setup Sheet**

**Be sure to read this sheet first.**

This sheet includes instructions for setting up your machine and getting it ready for use.

**Quick Start Guide** (This guide)

**Read this guide when starting to use the machine.**

After following instructions in your setup sheet, we recommend you read this guide to familiarize yourself with the basic operation of some of the main functions that can be performed on your machine.



### **On-screen Manuals**

#### **User's Guide**

**Read this guide when starting to use the machine.**

If the *Quick Start Guide* does not provide you enough information please refer to the *User's Guide* which can be installed from the *Setup CD-ROM*. This guide provides detailed instructions for:

- copying
- printing from your computer
- scanning

Additional guides are also available for advanced features.

#### **Scanning Guide**

Refer to this guide for full instructions on scanning operation and settings.

#### **PC Printing Guide**

Refer to this guide for full instructions on printer driver setting.

#### **PC Photo Printing Guide**

Refer to this guide for instructions on using the various application software included on the *Setup CD-ROM*.

# Reading the On-screen Manuals

---

For detailed instructions on installing the on-screen manuals, refer to your setup sheet.

You can view the on-screen manuals in the following way:

## Windows

To view the on-screen manual, double-click the **XXX On-screen Manual** shortcut icon on the desktop, or click **Start > All Programs** (or **Programs**) > **Canon XXX Manual > XXX On-screen Manual** (where “**XXX**” is your machine’s name).

### System Requirements

Browser: Windows HTML Help Viewer

---

#### Note

- Microsoft® Internet Explorer 5.0 or later must be installed.
  - The on-screen manual may not be displayed properly depending on your operating system or Internet Explorer version. We recommend that you keep your system up to date with Windows Update.
- 

## Macintosh

To view the on-screen manual, double-click the **XXX On-screen Manual** alias (where “**XXX**” is your machine’s name) on the desktop.

### System Requirements

Browser: Help Viewer

---

#### Note

- The on-screen manual may not be displayed properly depending on your operating system. We recommend that you keep your system up to date.
  - We recommend using Safari as your Web browser to view the HTML format on-screen manuals. If Safari is not installed on your computer, download it from Apple Inc. website and install it.
-



# Specifications

General Specifications	
<b>Printing resolution (dpi)</b>	4800 (horizontal)* x 1200 (vertical) * Ink droplets can be placed with a pitch of 1/4800 inch at minimum.
<b>Interface</b>	USB 2.0 High Speed* * A computer that complies with USB 2.0 Hi-Speed standard is required. Since the USB 2.0 Hi-Speed interface is fully upwardly compatible with USB Full-Speed (USB 1.1), it can be used at USB Full-Speed (USB 1.1).
<b>Print width</b>	8 inches / 203.2 mm max. (for Borderless Printing: 8.5 inches / 216 mm)
<b>Acoustic noise level</b>	Approx. 42.5 dB (A) * When printing in the highest print quality mode on Photo Paper Pro.
<b>Operating environment</b>	Temperature: 5 to 35°C (41 to 95°F) Humidity: 10 to 90% RH (no condensation)
<b>Storage environment</b>	Temperature: 0 to 40°C (32 to 104°F) Humidity: 5 to 95% RH (no condensation)
<b>Power supply</b>	AC 100-240 V, 50/60 Hz
<b>Power consumption</b>	Printing (Copy): Approx. 13 W Standby (minimum): Approx. 1.1 W OFF: Approx. 0.8 W
<b>External dimensions</b>	Approx. 17.7 (W) x 13.9 (D) x 6.7 (H) inches / Approx. 451 (W) x 353 (D) x 169 (H) mm * With the Paper Support and Paper Output Tray retracted.
<b>Weight</b>	Approx. 5.9 kg (Approx. 12.8 lb.) * With the FINE Cartridges installed.
<b>Canon FINE Cartridges</b>	Nozzles: Black: 320 nozzles Cyan/Magenta/Yellow: 384 x 3 nozzles

Copy Specifications	
<b>Multiple copy</b>	1 - 9, 20 pages

Scan Specifications	
<b>Scanner driver</b>	TWAIN / WIA (Windows Vista and Windows XP only)
<b>Maximum scanning size</b>	A4/Letter, 8.5" x 11.7" / 216 x 297 mm
<b>Scanning resolution</b>	Optical resolution (horizontal x vertical) max: 600 dpi x 1200 dpi Interpolated resolution max: 19200 dpi x 19200 dpi
<b>Gradation (Input/Output)</b>	16bit/8bit 48bit/24bit (RGB each 16bit/8bit)



## Camera Direct Print (PictBridge)

<b>Paper size</b>	4" x 6" / 101.6 x 152.4 mm, 5" x 7" / 127.0 x 177.8 mm*, Credit card, 8" x 10" / 203.2 x 254.0 mm, A4, Letter, Wide* * Can be selected only on certain Canon-brand PictBridge compliant devices.
<b>Paper type</b>	Default (Selections based on the machine setting), Photo (Photo Paper Plus Glossy, Glossy Photo Paper, Glossy Photo Paper "Everyday Use", Photo Paper Glossy, Photo Paper Plus Semi-gloss, Photo Stickers), Fast Photo (Photo Paper Pro), Plain Paper (A4/Letter only)
<b>Layout</b>	Default (Selections based on the machine setting), Borderless, Bordered, N-up (2, 4, 9, 16)* * Layout compatible with Canon-brand sticker above. Refer to "Printing Media" in the <i>User's Guide</i> on-screen manual.
<b>Image optimize</b>	Default (Selections based on the machine setting), On, Off, "VIVID"*, "NR" (Noise Reduction)*, "Face"*, "Red eye"* * If using a Canon PictBridge compliant camera, you can select it.
<b>Print data &amp; file no.</b>	Default (Off: No printing), Date, File No., Both, Off
<b>Trimming</b>	Default (Off: No trimming), On (follow camera's setting), Off

## Minimum System Requirements

### Note

Conform to the operating system's requirements when higher than those given here.

		
<b>Operating System</b>	Windows Vista	Mac OS X v.10.4
<b>Processor</b>	Pentium II (including compatible processors)	Intel processor
<b>RAM</b>	300 MHz 128 MB	PowerPC G3 256 MB
	Windows XP SP1, SP2	Mac OS X v10.2.8 - v10.3
	Pentium II (including compatible processors)	PowerPC G3
	300 MHz 128 MB	128 MB
	Windows 2000 Professional SP2, SP3, SP4	Note; Mac OS Extended(Journaled), Mac OS Extended
	Pentium II (including compatible processors)	
	300 MHz 128 MB	
	Note; Operation can only be guaranteed on a PC pre-installed Windows Vista, XP or 2000.	
<b>Browser</b>	Internet Explorer 6.0-	Safari
<b>Hard Disk Space</b>	800 MB Note; For bundled software installation.	700 MB Note; For bundled software installation.
<b>CD-ROM Drive</b>	Required	
<b>Other restrictions</b>	XGA 1024 x 768	

- OmniPage SE: Windows 2000 Professional SP2 and SP3 not supported
- MP Navigator EX: QuickTime v6.4 or later is needed (Macintosh only)
- Some functions may not be available with Windows Media Center
- To upgrade from Windows XP to Windows Vista, first uninstall software bundled with the Canon inkjet printer.

## Additional System Requirements for On-Screen Manuals

### Windows

Browser: Windows HTML Help Viewer

Note: Microsoft Internet Explorer 5.0 or later must be installed. The on-screen manual may not be displayed properly depending on your operating system or Internet Explorer version. We recommend that you keep your system up to date with Windows Update.

### Macintosh

Browser: Help Viewer

Note: The on-screen manual may not be displayed properly depending on your operating system or Help Viewer version. We recommend that you keep your system up to date with Software Update.

Specifications are subject to change without notice.

# ▲ Safety Precautions

Please read the safety warnings and cautions provided in this manual to ensure that you use the machine safely. Do not attempt to use the machine in any way not described in this manual.

## ▲ Warning

You may cause an electric shock, fire, or damage the machine if you ignore any of these safety precautions.

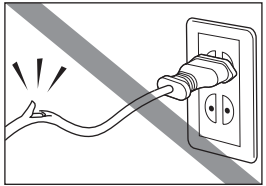
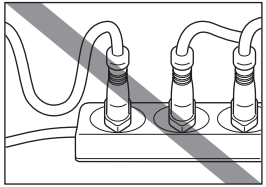
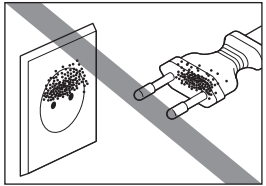
<b>Choosing a location</b>	Do not place the machine close to flammable solvents such as alcohol or thinners.	
<b>Power supply</b>	Never attempt to plug in or unplug the machine from the power supply when your hands are wet. Always push the plug all the way into the power outlet.	
	Never damage, modify, stretch or excessively bend or twist the power cord. Do not place heavy objects on the power cord.	
	Never plug the machine into a power socket that is shared with other equipment (extension lead/cord, 2- or 3-way adapter, etc.).	
	Never use the machine if the power cord is bundled or knotted.	
	If you detect smoke, unusual smells or strange noises around the machine, immediately unplug the machine at the power supply and call for service.	
	Periodically, unplug the machine and use a dry cloth to wipe off any dust or dirt collected on the plug and the power outlet. If the machine is placed at a location exposed to a lot of dust, smoke, or high humidity, the dust collected on the plug absorbs moisture and may cause insulation failure and fire.	
	If you hear thunder, disconnect the power supply of the machine and refrain from using it. Leaving the machine plugged in may cause fire, electric shock, or damage to the machine, depending on the thunder storm.	
Use the power cable included with the machine.		

<p><b>Cleaning the machine</b></p>	<p>Use a damp cloth to clean the machine. Never use flammable solvents such as alcohol, benzene or thinners. If flammable solvents come in contact with electrical components inside the machine, it could cause a fire or electric shock.</p>	
<p>Always unplug the machine from the power outlet before cleaning the machine. If you accidentally switch the machine on while cleaning it, you could injure yourself or damage the machine.</p>		
<p><b>Maintaining the machine</b></p>	<p>Do not attempt to disassemble or modify the machine. There are no user serviceable parts inside the machine. The machine contains high-voltage components. Never attempt any maintenance procedure not described in this guide.</p>	
<p><b>Working around the machine</b></p>	<p>Do not use highly flammable sprays near the machine. This could cause a fire or electric shock if the spray comes into contact with electrical components inside the machine.</p>	

**⚠ Caution**

You may cause injury or damage the machine if you ignore any of these safety precautions.

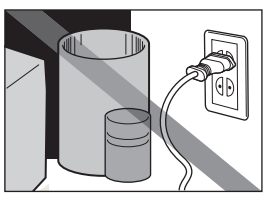
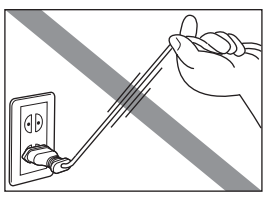
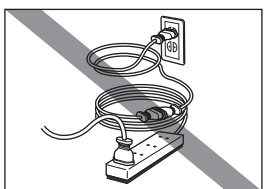
<p><b>Choosing a location</b></p>	<p>Do not install the machine in a location that is unstable or subject to excessive vibration. Do not install the machine in locations that are very humid or dusty, in direct sunlight, outdoors, or close to a heating source. To avoid the risk of fire or electric shocks, install the machine in a location with an ambient temperature range of 5°C to 35°C (41°F to 95°F) and humidity of 10% to 90% (condensation free). Do not place the machine on a thick rug or carpet. Do not place the machine with its back attached to the wall.</p>	
<p><b>Power supply</b></p>	<p>Ensure that the area around the power outlet is kept clear at all times so you can easily unplug the power cord if necessary.</p>	
<p>Never remove the plug by pulling on the cord.</p>		
<p>Do not use an extension lead/cord.</p>		

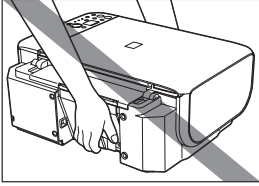
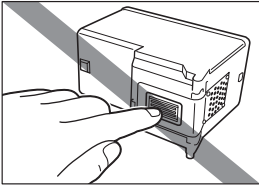
<b>Working around the machine</b>	<p>Never put your hands or fingers in the machine while it is printing.</p> <p>When moving the machine, carry the machine at both ends. Do not hold the rear side of the machine.</p> 
	<p>Do not place any object on the machine.</p>
	<p>Do not place metal objects (paper clips, staples, etc.) or containers of flammable solvents (alcohol, thinners, etc.) on top of the machine.</p>
	<p>If any foreign object (metal or liquid) fall into the machine, unplug the power cord and call for service.</p>
	<p>Do not transport or store the machine on a slant, vertically or upside-down, as the ink may leak and damage the machine.</p>
	<p>When loading a thick book on the Platen Glass, do not press hard on the Document Cover. The Platen Glass may break and cause injury.</p>
<b>FINE Cartridges (Ink Cartridges)</b>	<p>For safety reasons, store FINE Cartridges (Ink Cartridges) out of the reach of small children. If a child ingests any ink, consult a doctor immediately.</p>
	<p>Do not shake FINE Cartridges (Ink Cartridges). Ink may spill out and stain clothing or the surrounding area.</p>
	<p>Never touch the electrical contacts or Print Head Nozzles on a FINE Cartridge (Ink Cartridge) after printing. The metal parts may be very hot and could cause burns.</p> 
	<p>Do not throw FINE Cartridges (Ink Cartridges) into fire.</p>

# Legal Limitations on Use of Your Product and Use of Images

---

It may be unlawful to make copies of, scan, print, or use reproductions of the following documents. The list provided is non-exhaustive. When in doubt, check with a legal representative in your jurisdiction.

- Paper money
- Money orders
- Certificates of deposit
- Postage stamps (canceled or uncanceled)
- Identifying badges or insignias
- Selective service or draft papers
- Checks or drafts issued by governmental agencies
- Motor vehicle licenses and certificates of title
- Traveler's checks
- Food stamps
- Passports
- Immigration papers
- Internal revenue stamps (canceled or uncanceled)
- Bonds or other certificates of indebtedness
- Stock certificates
- Copyrighted works/works of art without permission of copyright owner

# Users in the U.S.A.

---

## ■ Regulatory Information

### FCC Notice (U.S.A. Only)

#### For 120V, 60Hz model

Model Number: K10308

This device complies with Part 15 of the FCC Rules. Operation is subject to the following two conditions: (1) This device may not cause harmful interference, and (2) this device must accept any interference received, including interference that may cause undesired operation.

Note: This equipment has been tested and found to comply with the limits for a Class B digital device, pursuant to Part 15 of the FCC Rules. These limits are designed to provide reasonable protection against harmful interference in a residential installation. This equipment generates, uses and can radiate radio frequency energy and, if not installed and used in accordance with the instructions, may cause harmful interference to radio communications.

However, there is no guarantee that interference will not occur in a particular installation. If this equipment does cause harmful interference to radio or television reception, which can be determined by turning the equipment off and on, the user is encouraged to try to correct the interference by one or more of the following measures:

- Reorient or relocate the receiving antenna.
- Increase the separation between the equipment and receiver.
- Connect the equipment into an outlet on a circuit different from that to which the receiver is connected.
- Consult the dealer or an experienced radio/TV technician for help.

Use of a shielded cable is required to comply with Class B limits in Subpart B of Part 15 of the FCC Rules.

Do not make any changes or modifications to the equipment unless otherwise specified in the manual. If such changes or modifications should be made, you could be required to stop operation of the equipment.

Canon U.S.A., Inc.  
One Canon Plaza  
Lake Success, NY 11042  
1-516-328-5600

## ■ Canon U.S.A., INC. LIMITED WARRANTY --- (USA Only)

The limited warranty set forth below is given by Canon U.S.A., Inc. ("Canon USA") with respect to the new or refurbished Canon-brand product ("Product") packaged with this limited warranty, when purchased and used in the United States only.

The Product is warranted against defects in materials and workmanship under normal use and service for a period of ninety (90) days from the date of original purchase. Product returned to a Canon USA repair facility or a Canon USA Authorized Service Facility ("ASF"), and proven to be defective upon inspection will be (a) repaired utilizing new, remanufactured, repaired and/or recycled parts (b) exchanged for new or; (c) exchanged for a refurbished Product, as determined by the Canon USA repair facility or the ASF.

Warranty repair or replacement shall not extend the original warranty period of the Product. A dated proof of purchase is required at the time of warranty service. A copy of your dated bill of sale will satisfy this requirement. This warranty does not cover any accessories, or any consumables, such as paper or ink cartridges, as to which there shall be no warranty or replacement.



This limited warranty shall only apply if the Product is used in conjunction with compatible computers, peripheral equipment and software. Canon USA shall have no responsibility for such items except for compatible Canon brand peripheral equipment covered by a separate warranty ("Separate Warranty"). Repairs of such Canon brand peripheral equipment shall be governed by the terms of the Separate Warranty. Non-Canon brand equipment and software that may be distributed with the Product are sold "as is" and without warranty of any kind by Canon USA, including any implied warranty regarding merchantability or fitness for a particular purpose, and all such warranties are disclaimed. The sole warranty, if any, with respect to such non-Canon brand items is given by the manufacturer or producer thereof.

This limited warranty covers all defects encountered in normal use of the Product and does not apply in the following cases:

- (a) Loss of or damage to the Product due to abuse, neglect, mishandling, improper packaging by you, alteration, accident, electrical current fluctuations, improper use, failure to follow operating or maintenance instructions in, or environmental conditions prescribed in, Canon USA's user's manual or other documentation, or services performed by someone other than a Canon USA repair facility or ASF. Without limiting the foregoing, dropping the Product, scratches, and abrasions will be presumed to have resulted from misuse, abuse or failure to operate the Product as set forth in the user's manual or other documentation for the Product.
- (b) Use of parts, media, software or supplies (other than those sold by Canon USA), including non-Canon ink cartridges or refilled ink cartridges, that cause damage to the Product or cause abnormally frequent service calls or service problems.
- (c) If the Product has had its serial number or dating defaced, altered or removed.

ANY SYSTEM SOFTWARE (WHETHER FACTORY LOADED ON THE PRODUCT OR CONTAINED ON THE SOFTWARE DISKETTES OR CD-ROMS ENCLOSED WITH, OR ACCOMPANYING, THE PRODUCT), AND ANY UTILITY SOFTWARE, DISTRIBUTED WITH OR FOR THE PRODUCT, IS SOLD "AS IS" AND WITHOUT WARRANTY BY CANON USA. THE SOLE WARRANTY WITH RESPECT TO SUCH SOFTWARE IS CONTAINED IN THE SOFTWARE MANUFACTURER'S LICENSE AGREEMENT DISTRIBUTED THEREWITH, INCLUDING ANY LIMITATIONS AND DISCLAIMERS THEREON. PLEASE CONTACT CANON USA IMMEDIATELY IF YOU HAVE NOT RECEIVED A COPY OF THE SOFTWARE MANUFACTURER'S LICENSE AGREEMENT.

NO IMPLIED WARRANTY, INCLUDING ANY IMPLIED WARRANTY OF MERCHANTABILITY OR FITNESS FOR A PARTICULAR PURPOSE, APPLIES TO THE PRODUCT AFTER THE APPLICABLE PERIOD OF THE EXPRESS LIMITED WARRANTY STATED ABOVE, AND NO OTHER EXPRESS WARRANTY OR GUARANTY, EXCEPT AS MENTIONED ABOVE, GIVEN BY ANY PERSON OR ENTITY WITH RESPECT TO THE PRODUCT SHALL BIND CANON USA, OR ITS ASF. (SOME STATES DO NOT ALLOW LIMITATIONS ON HOW LONG AN IMPLIED WARRANTY LASTS, SO THE ABOVE LIMITATION MAY NOT APPLY TO YOU.) CANON USA SHALL NOT BE LIABLE FOR LOSS OF REVENUES OR PROFITS, INCONVENIENCE, EXPENSE FOR SUBSTITUTE EQUIPMENT OR SERVICE, STORAGE CHARGES, LOSS OR CORRUPTION OF DATA, OR ANY OTHER SPECIAL, INCIDENTAL OR CONSEQUENTIAL DAMAGES CAUSED BY THE USE, MISUSE, OR INABILITY TO USE THE PRODUCT REGARDLESS OF THE LEGAL THEORY ON WHICH THE CLAIM IS BASED, AND EVEN IF CANON USA OR ITS ASF HAS BEEN ADVISED OF THE POSSIBILITY OF SUCH DAMAGES. NOR SHALL RECOVERY OF ANY KIND AGAINST CANON USA OR ITS ASF BE GREATER IN AMOUNT THAN THE PURCHASE PRICE OF THE PRODUCT CAUSING THE ALLEGED DAMAGE. WITHOUT LIMITING THE FOREGOING, YOU ASSUME ALL RISK AND LIABILITY FOR LOSS, DAMAGE OR INJURY TO YOU AND YOUR PROPERTY AND TO OTHERS AND THEIR PROPERTY ARISING OUT OF THE POSSESSION, USE, MISUSE, OR INABILITY TO USE THE PRODUCT SOLD BY CANON USA NOT CAUSED SOLELY AND DIRECTLY BY THE NEGLIGENCE OF CANON USA, OR ITS ASF. (SOME STATES DO NOT ALLOW THE EXCLUSION OR LIMITATION OF INCIDENTAL OR CONSEQUENTIAL DAMAGES, SO THE ABOVE EXCLUSION OR LIMITATION MAY NOT APPLY TO YOU.) THIS LIMITED WARRANTY SHALL NOT EXTEND TO ANYONE OTHER THAN THE

ORIGINAL PURCHASER OF THE PRODUCT OR THE PERSON FOR WHOM IT WAS PURCHASED AS A GIFT, AND STATES YOUR EXCLUSIVE REMEDY.

Canon USA offers a range of customer technical support\* options:

- Interactive troubleshooting, e-mail technical support, the latest driver downloads and answers to frequently asked questions ([www.canontechsupport.com](http://www.canontechsupport.com))
- Toll-free live technical support Monday-Saturday (excluding holidays) at 1-800-828-4040
- Telephone Device for the Deaf (TDD-1-866-251-3752)
- Repair or Exchange Service Options:  
In the event service is required for the Product during the limited warranty period, Canon USA offers two hardware support options:

#### **Authorized Service Facility Carry-In / Mail-In Service**

Canon USA's Carry-In/Mail-In Service provides repair or exchange, at Canon USA's option, through Canon USA's Authorized Service Facility (ASF) network. The name and telephone number of the ASF(s) near you may be obtained from Canon USA's Web site at [www.canontechsupport.com](http://www.canontechsupport.com) or by calling the Canon USA Customer Care Center at 1-800-828-4040, or any time while speaking to a technical support person. A Product covered by this limited warranty will be repaired or exchanged, as determined by Canon USA, and returned without charge by the ASF.

#### **InstantExchange Service \*\***

A Canon Customer Care Center or ASF technician will attempt to diagnose the nature of the problem and, if possible, correct it over the telephone. If the problem cannot be corrected over the telephone, and you elect the InstantExchange option, a reference number will be issued to you. You will be asked for the Product serial number and other information pertaining to your Product and for a ship-to location for the replacement Product (must include street address).

The Canon USA repair facility will ship out the replacement Product prepaid by Canon USA. After receipt of the replacement Product (with instructions and a prepaid waybill), follow the enclosed instructions on how to ship your product to the Canon USA repair facility. Your Product must be returned in the shipping carton in which the replacement Product was packed and include the reference number, A COPY OF YOUR DATED PROOF OF PURCHASE (BILL OF SALE), and a complete explanation of the problem. DO NOT INCLUDE ANY OTHER ITEMS WITH THE YOUR PRODUCT IN THE RETURN SHIPPING CARTON, AND BE SURE TO RETAIN YOUR PRINTHEAD, INK CARTRIDGE(S) AND TANK(S).

InstantExchange Service exchanges your Product with a replacement Product, which will normally be shipped the same day if your request for this service is by 3 p.m. E.T. Monday through Friday, except holidays. Canon USA does not guarantee same day shipment in the event of the occurrence of factors beyond its reasonable control. The replacement Product you receive may be a refurbished or reconditioned unit and will be covered for the balance of the period remaining on your original limited warranty. NOTE THAT BY USING THIS SERVICE YOU WILL KEEP THE REPLACEMENT PRODUCT THAT IS SENT TO YOU. CANON USA WILL RETAIN THE PRODUCT THAT YOU ORIGINALLY PURCHASED, WHICH SHALL BECOME THE PROPERTY OF CANON USA. InstantExchange warranty program service is available only during the express limited-warranty period for your Product and only in the continental United States, Alaska and Hawaii during such period.

This limited warranty gives you specific legal rights, and you may also have other rights, which vary from state to state.

\* Support program specifics are subject to change without notice.

\*\* InstantExchange warranty service is subject to the availability of refurbished or new replacement units.

**Canon U.S.A., Inc.**  
**One Canon Plaza**  
**Lake Success, NY 11042**  
**USA**

Canon is a registered trademark of Canon Inc.

©2007 Canon U.S.A., Inc. Canon is a registered trademark of Canon Inc. in the United States and may also be a registered trademark in other countries.

# Index

## A

Appendix 59

## B

Before Using the Machine 2

## C

Canon U.S.A., Inc. Limited Warranty - U.S. Only 68

Cleaning

exterior 40

inside 41

platen glass and document cover 40

protrusions inside the machine 42

roller 41

Copying 15

## E

Error Code 44

## H

Handling the Original Document 6

## L

Legal Limitations on Use of Your Product and Use  
of Images 67

Loading Original Documents 6

Loading Printing Paper

envelopes 12

paper 10

recommended paper and requirements 8

small-sized paper 14

## M

Maintenance Codes 25

Media

cannot use 9

specialty 7

Media Type 8

## N

Nozzle Check Pattern

examining 28

printing 27

## P

Print Head

aligning 31

cleaning 29

deep cleaning 30

Printing from Your Computer

Macintosh 18

Windows 17

Printing Photographs Directly from a Compliant

Device 20

PictBridge print settings 22

## R

Replacing a FINE Cartridge 33

ink status information 33

Routine Maintenance 25

## S

Safety Precautions 64

Scanning Images 19

Specialty Media 7

Specifications 61

PictBridge 62

## T

Troubleshooting 43

Turning off the Machine 4

Turning on the Machine 4





# Ordering Information

For additional supplies, use the following descriptions and order numbers.

<b>Description</b>	<b>Order #</b>
<b>FINE Cartridges</b>	
PG-30 Black	1899B002
CL-31 Color	1900B002
PG-40 Black	0615B002
CL-41 Color	0617B002
<b>Canon Specialty Papers</b>	
All Occasion Photo Cards (4" x 8"/ 50 sheets)	1029A069
Glossy Photo Paper Credit Card Size (100 Sheets)	9157A023
High Resolution Paper (8.5" x 11"/ 100 sheets)	1033A011
Matte Photo Paper (4" x 6"/ 120 sheets)	7981A014
Matte Photo Paper (8.5" x 11"/ 50 sheets)	7981A004
Photo Paper Glossy (4" x 6"/ 50 sheets)	0775B021
Photo Paper Glossy (4" x 6"/ 100 sheets)	0775B022
Photo Paper Glossy (8.5" x 11"/ 50 sheets)	0775B023
Photo Paper Glossy (8.5" x 11"/ 100 sheets)	0775B024
Photo Paper Plus Double Sided (5" x 7"/ 10 sheets)	9981A006
Photo Paper Plus Double Sided (8.5" x 11"/ 10 sheets)	9981A005
Photo Paper Plus Double Sided Album Kit (5" x 7")	0041B005
Photo Paper Plus Double Sided Album Kit (8.5" x 11")	0041B006
Photo Paper Plus Glossy (4" x 6"/ 20 sheets)	7980A007
Photo Paper Plus Glossy (4" x 6"/ 50 sheets)	7980A012
Photo Paper Plus Glossy (4" x 6"/ 120 sheets)	7980A022
Photo Paper Plus Glossy (5" x 7"/ 20 sheets)	7980A019
Photo Paper Plus Glossy (8.5" x 11"/ 20 sheets)	7980A006
Photo Paper Plus Semi-gloss (4" x 6"/ 50 sheets)	1686B014
Photo Paper Plus Semi-gloss (8" x 10" / 20 sheets)	1686B017
Photo Paper Plus Semi-gloss (8.5" x 11"/ 20 sheets)	1686B020
Photo Paper Pro (4" x 6"/ 20 sheets)	1029A014
Photo Paper Pro (4" x 6"/ 75 sheets)	1029A027
Photo Paper Pro (8" x 10"/ 20 sheets)	1029A059
Photo Paper Pro (8.5" x 11"/ 15 sheets)	1029A004
Photo Paper Pro (8.5" x 11"/ 30 sheets)	1029A028
Photo Stickers (16 stickers/sheet, 5 sheets/pack)	0001C001

Call **1-800-OK-CANON** to locate a dealer near you, or visit the Canon eStore at [www.estore.usa.canon.com](http://www.estore.usa.canon.com).



© 2007 Canon U.S.A., Inc. Canon is a registered trademark of Canon Inc. in the United States and may be a registered trademark or trademarks in other countries. All other product and brand names are trademarks of their respective owners. As an ENERGY STAR® partner, Canon U.S.A., Inc. has determined that this product meets the ENERGY STAR® guidelines for energy efficiency.

The following FINE Cartridges are compatible with this product.



For information on product specifications, please visit our website at [www.usa.canon.com](http://www.usa.canon.com)