

DENON[®]

DHT-S716H

NETWORK SOUND BAR

Owner's Manual

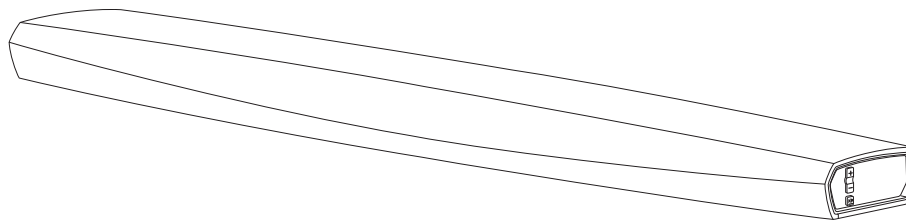

Introduction	6	Setting up your first DHT-S716H	24
Before your begin	7	Adding more HEOS devices	25
System requirements	7	Adding wired HEOS devices	25
Network requirements	7	Adding wireless HEOS devices	25
Controller requirements	8	Connecting devices	26
Getting to know your DHT-S716H	9	Connecting to your TV	26
Front panel	11	HDMI connection	26
Controls	12	Setting the HDMI control function	26
Bottom	13	Disable your television's speakers	27
Back panel	14	Playing HDMI (ARC) - Best choice	28
Remote control unit	16	Playing HDMI (without ARC) - Better choice	29
Placing your DHT-S716H	17	Connecting an other devices	30
Tabletop	17	Connecting to your HDMI equipment	30
How to attach the feet	17	Connecting an audio playback device	30
IR repeater	18	Connecting a USB storage device	31
Wall-Mounting	19	IR repeater	31
Before using the remote control unit	20	Pairing a DSW-1H and Surrounds	32
Replacing the battery	20	Pairing the DSW-1H	33
Operating range of the remote control unit	21	Adding surround speakers	33
Powering your DHT-S716H	22	Unpairing DSW-1H and Surrounds	34
Getting the HEOS app	23		



Using your DHT-S716H	35	Playing music stored on your mobile device	48
HEOS account	35	Playing music from your networked PC or NAS	49
What is a HEOS account?	35	Streaming an external audio device to any HEOS device	50
Why do I need a HEOS account?	35	Playing music from a USB device	51
Signing up for a HEOS account	35	Playing music from Bluetooth device	52
Selecting a room/device	35	Pairing the HEOS device with your Bluetooth devices	52
Listening to the same music in multiple rooms	36	Playing from streaming music services	53
Grouping rooms	36	Adding a music service	53
Ungrouping rooms	37	Changing music service settings	53
Grouping all rooms (party mode)	38	Managing inputs	54
Ungrouping all rooms	39	Changing the name of the inputs	54
Selecting the music track or station from music sources	40	Hiding an input	54
Rearranging the now playing queue	42	Managing your phone	55
Deleting songs from the play queue	42	Using the favorite	55
Deleting all songs from the play queue	43	Adding to HEOS favorite	55
Saving playlists	43	Deleting station from the HEOS favorite	55
Quick Select function	44		
Watching TV	45		
Watching other device	46		
Listening to radio	47		



Making adjustments	56	Basic troubleshooting	63
Adjusting the audio quality	56	My HEOS device won't connect to my network using the audio cable	63
Changing the TV connection	57	If the TV remote control does not work	63
Adjusting the TV input	57	Cannot pair a Bluetooth mobile device with the HEOS device	64
TV Sound Grouping	57	Cannot hear Bluetooth music	64
Changing the name of Quick Select	58	My HEOS device turns off and the status LED flashes in red	65
Adjusting the status light brightness	58	Music cuts out or delays sometimes	65
Updating your system	59	I hear a delay when using the external input with my TV	65
Advanced features	60	I hear distortion when using the AUX input	66
Wireless performance	60	Connecting to a WPS network	66
Power management	61	Resetting your HEOS device	67
Power modes	61		
Quick Start Mode	61		
Deep Standby	62		
Off	62		



Status LED table	68
Supported file types and codecs	75
Supported audio formats (Coaxial/Optical)	75
Specifications	76
Information	78
Trademarks	78
License	80
License information for the software used in the unit	80



Thank you for purchasing this Denon product. To ensure proper operation, please read this owner's manual carefully before using the product.

NOTE

- THIS DOCUMENT CONTAINS INFORMATION THAT IS SUBJECT TO CHANGE WITHOUT NOTICE.

Introduction

The DHT-S716H is part of the HEOS wireless multi-room sound system that enables you to enjoy your favorite music anywhere and everywhere around your home. By utilizing your existing home network and the HEOS app on your iOS or Android™ device, you can explore, browse, and play music from your own music library or from many online streaming music services.

- True multi-room audio - play different songs in different rooms or the same song in every room
- Utilizes your existing home wireless network for quick and easy setup
- Industry leading microsecond audio synchronization between HEOS device
- Legendary Denon audio quality
- If you are in a hurry, you can be enjoying great sounding music in no time by following the steps outlined in the Quick Start Guide (supplied).



Please continue reading this Owner's Manual for more detailed information about the features and benefits of your DHT-S716H.



Before your begin

NOTE

- If you have already installed at least one HEOS device, please skip to the section "Adding more HEOS devices" (🔍 p. 25).

System requirements

Before you begin installing your first HEOS device, please make sure you understand and meet a few basic requirements.

■ Network requirements

Wireless Router - In order to use your HEOS music system, you must have a working wireless (Wi-Fi) or ethernet network in your home. Even when connected to an Ethernet network, a Wi-Fi connection to the router is required to control the system using the HEOS Control app. If you do not have a wireless network, please contact your local Denon dealer or electronics retailer to assist you with purchasing and installing a wireless network in your home.

High Speed Internet Connection - HEOS accesses the Internet to stream music to your home from many popular online music services. HEOS is also designed to provide you with software updates, which are delivered via your home Internet connection. DSL, Cable, and Fiber services will provide the best experience and reliability. You may experience performance issues with slower Internet connections like satellite based services.



■ Controller requirements

You can control your HEOS wireless multi-room sound system using the free HEOS app on any iOS or Android mobile device that meets these minimum requirements:



iOS Minimum Requirements

- iOS version 8.0 or later
- iPhone® 4S or newer
- iPad® 2 or newer
- iPod touch® (5th generation) or newer



Android Minimum Requirements

- Android OS version 4.0 or later
- All resolutions



Getting to know your DHT-S716H

Unpack your DHT-S716H from the box and verify that the following items are included:

DHT-S716H

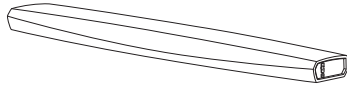

Quick Start Guide

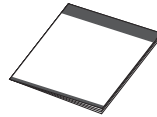

Safety instructions



Warranty
(North America model only)



Power cord

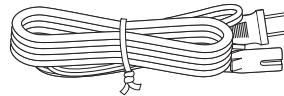

1/8 inch (3.5 mm) setup cable



Ethernet cable

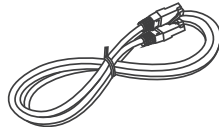

HDMI cable

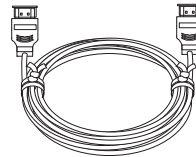

Optical cable

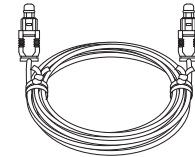

Riser feet

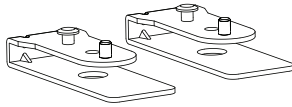

Remote control unit
(include battery)

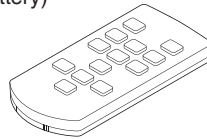

Wall mount template

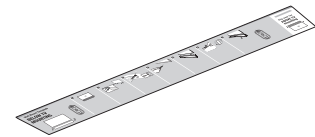

NOTE

- Please use the power cord included in the box for your device.



■ Front panel

[Tabletop]

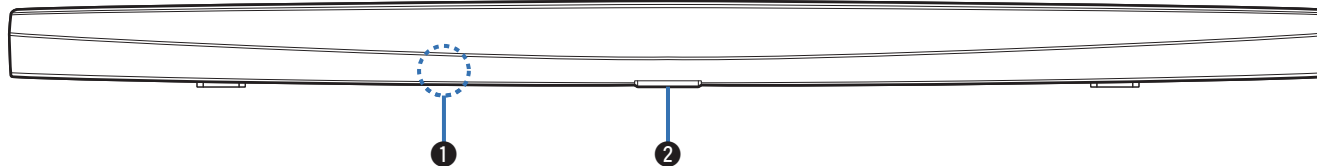

[Wall mount]

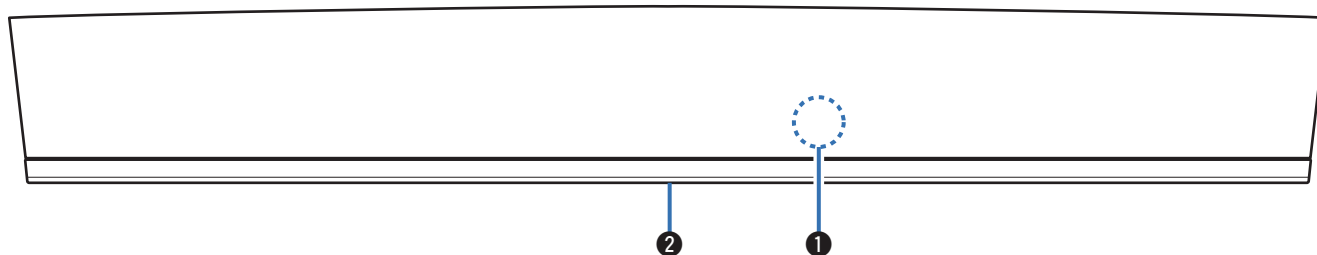

① Remote control sensor

This receives signals from the remote control unit.

② Status LED

Please refer to the “Status LED table” for LED color and state meaning. (📖 p. 68)



■ Controls

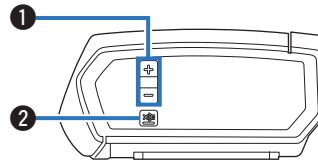

① Volume up/down buttons (+, -)

Adjusts the HEOS device's volume level up or down.

② Mute button (⏸)

Mutes or unmutes the HEOS device's volume.



■ Bottom

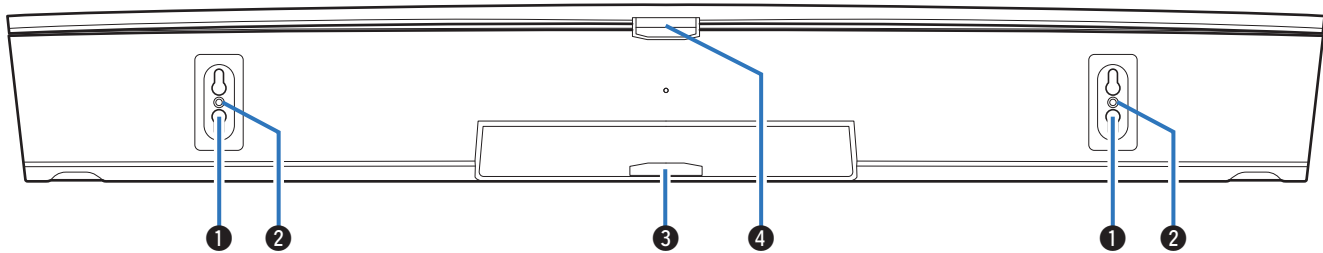

① Keyhole (for wall mount)

② Threaded mounting hole (for wall mount)

Used to mount this unit on a wall or ceiling.

③ Status LED (for wall mount)

Please refer to the "Status LED table" for LED color and state meaning. (☞ p. 68)

④ Status LED (for tabletop)

Please refer to the "Status LED table" for LED color and state meaning. (☞ p. 68)



■ Back panel

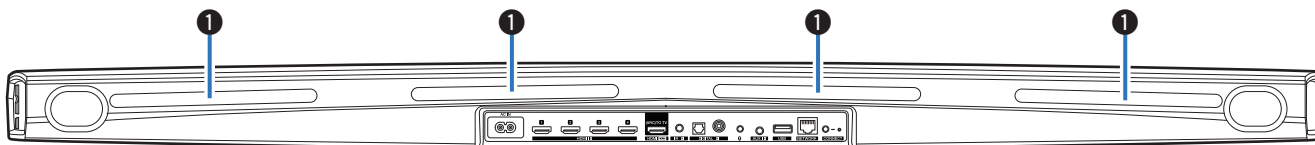

1 IR repeater

Remote control signals received by the DHT-S716H are re-sent from the rear of the DHT-S716H. (👉 p. 18)



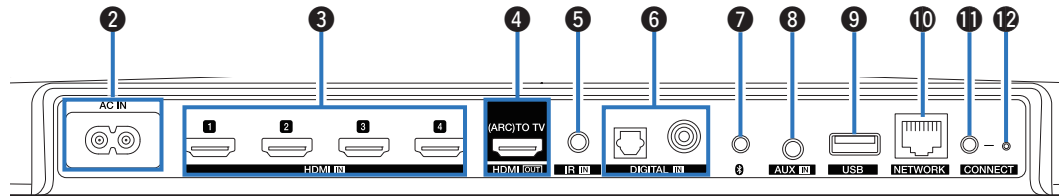

2 AC inlet (AC IN)

Used to connect the power cord. (👉 p. 22)

3 HDMI connectors (HDMI IN)

Used to connect to the HDMI equipment with an HDMI cable.
(👉 p. 30)

4 HDMI connector to TV (HDMI OUT)

Used to connect to the TV with an HDMI cable. (Compatible with the ARC function) (👉 p. 26)

5 REMOTE CONTROL jack (IR IN)

Used to connect infrared receivers/transmitters in order to operate this unit and external devices from a different room. (👉 p. 31)

6 Digital audio connectors (DIGITAL IN)

Used to connect devices equipped with digital audio outputs.
(👉 p. 30)

7 Bluetooth button (📶)

Used in the Bluetooth pairing settings. (👉 p. 52)

8 AUX jack (AUX IN)

Used to connect audio devices with a 1/8 inch (3.5 mm) cable.
(👉 p. 30)

Used to add the HEOS device to your wireless network.
(👉 p. 24)

9 USB port

Used to connect USB storage devices. (👉 p. 31)

10 NETWORK connector

Used to connect this unit to a wired Ethernet network. (👉 p. 24)

11 CONNECT button

Used for Wi-Fi setup.

12 Connect in status LED

Indicates the status of this unit. (👉 p. 68)



■ Remote control unit

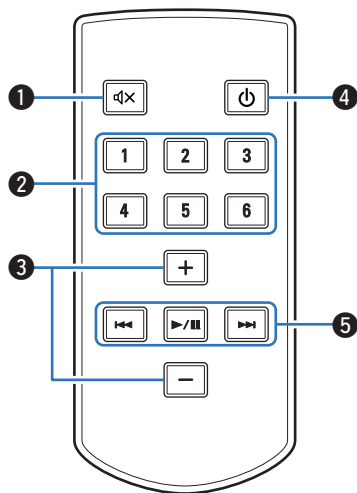

① Mute button (🔇)

This mutes the output audio.

② Quick Select buttons (1 – 6)

These call up settings registered to each button, such as input source, volume level and sound mode settings. (👉 p. 44)

③ Volume up/down buttons (+, -)

These adjust the volume level.

④ Power button (🔌)

This toggles the power mode of this unit.

⑤ System buttons

These perform playback related operations.

- Reverse-skip / Forward-skip buttons (⏮️, ⏭️)
- Play/pause button (▶️/⏸️)



Placing your DHT-S716H

The DHT-S716H is designed to enhance the sound of your TV and allow you to enjoy HEOS Wireless Multi-Room Sound. Place the DHT-S716H at a convenient location near the TV.

- The DHT-S716H must be within range of your wireless network.

Tabletop

The DHT-S716H should be placed as close as possible to the TV screen. It should be centered left-to-right with the screen, and ideally no more than a few inches above or below. The most common location is below the screen. Sometimes this location can be difficult, because the base of the TV gets in the way. The DHT-S716H has a set of feet that raise the DHT-S716H, for a more stable and attractive installation when used with this type of TV.

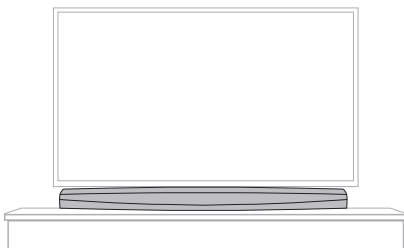

How to attach the feet

Attach the supplied feet if you need to raise the DHT-S716H over your TV stand base.

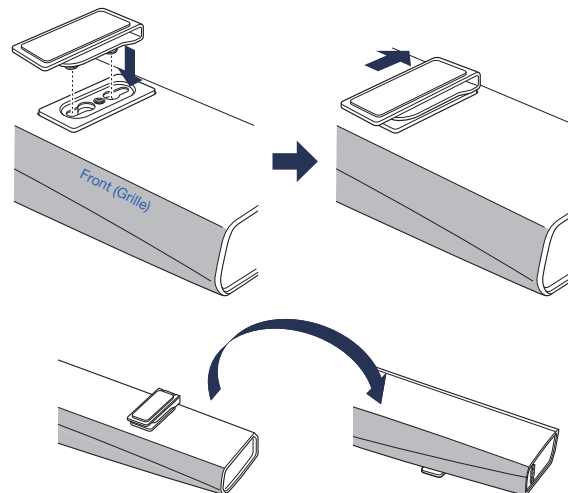

■ IR repeater

Depending on your TV model or installation location, the remote control receiver on the TV may be hidden by the DHT-S716H, preventing the remote control from being used because the remote control signals cannot reach the TV.

Remote control signal DHT-S716H has been received, will be re-sent from the back of the DHT-S716H.

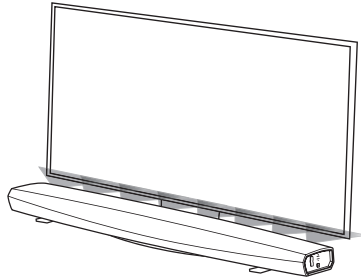

Wall-Mounting

The DHT-S716H can be wall-mounted using the integrated keyhole mounts. A mounting template can be found in the product carton. Using a level, position and tape the template to the wall in the desired location. Install hardware* using the template as a guide and then remove the mounting template from the wall. Connect the audio and power cables prior to mounting the DHT-S716H on the wall.

* Consult a person knowledgeable about your wall type to recommend suitable hardware for hanging the speaker.

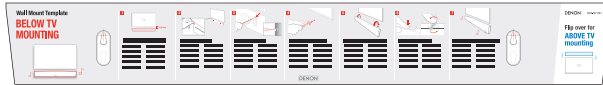

NOTE

- To ensure safety, request a contractor perform the mounting work when mounting onto a wall.
- In order to use the unit safely, do not place items on or hang items from the unit.
- Be sure to fix connection cables to the wall to ensure that cannot be pulled or tripped over causing the unit to fall. Check that the unit is mounted safely after the mounting work is complete. Recommend installing a safety wire (not included) at the safety wiring hole on the bottom of the DHT-S716H in order to prevent injury to the user and others or damage to property should the DHT-S716H fall for some reason.
- Also, periodically check the safety of the unit and whether there is a possibility that the unit may fall.
- Denon cannot accept any responsibility for damage, injury or accidents caused by problems with the mounting location or mounting method.



Before using the remote control unit

The remote control unit has a built-in lithium battery.
Pull out the insulation sheet before use.

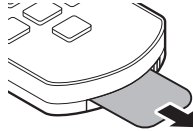

NOTE

- When inserting the lithium battery, be sure to do so in the proper direction, following the \oplus and \ominus marks in the battery compartment.
- If the battery should have a leakage, immediately replace and dispose of the battery. In this case, there is a risk of burn when the liquid comes in contact with skins or clothes, so a great care should be taken. If the liquid accidentally comes in contact, wash with tap water and consult a doctor.
- Remove the battery from the remote control unit if it will not be in use for long periods.

Replacing the battery

1. Pull the groove on the left side of the battery case at the bottom of the reverse side of the remote control unit to the right.
2. In this state, pull the battery case downwards.

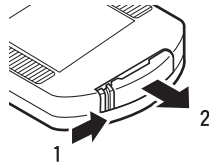

3. Insert the lithium battery (CR2025) correctly into the battery compartment as indicated.
4. Replace the battery case in the original position.

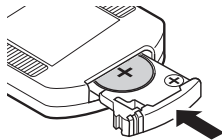

■ Operating range of the remote control unit

Point the remote control unit at the remote sensor when operating it.

[Tabletop]

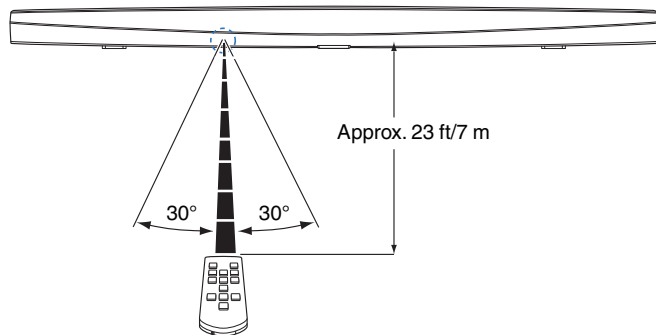

[Wall mount]

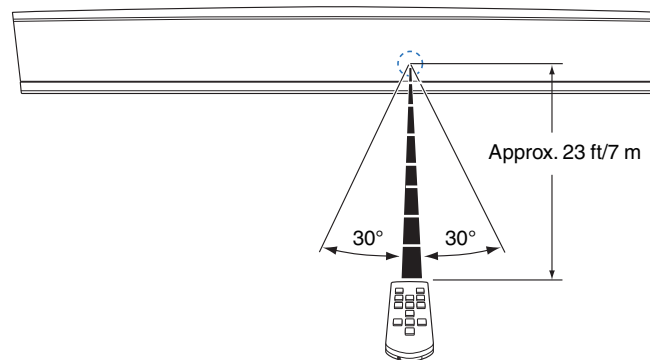

Powering your DHT-S716H

Connect the power cord included in the box to the back of the DHT-S716H and the plug to a wall outlet.

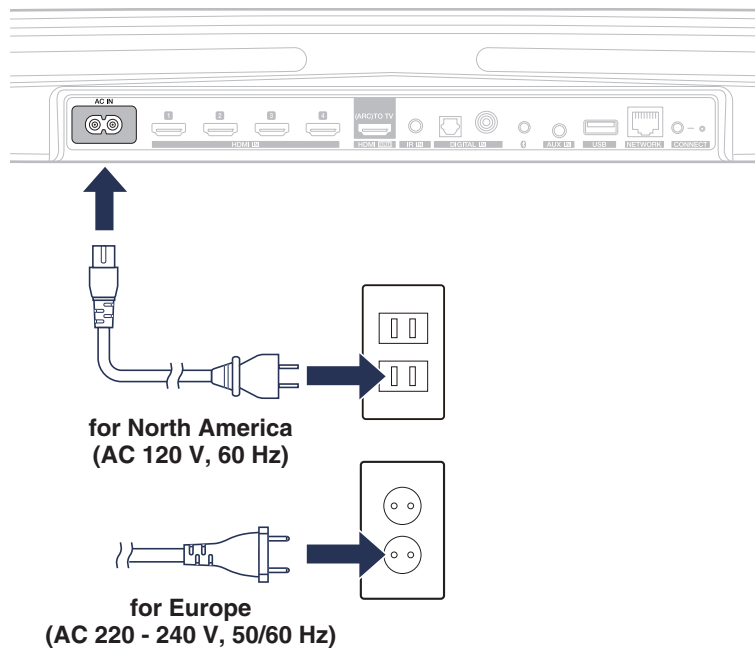

Getting the HEOS app

The HEOS app is the heart of the HEOS experience. Using your mobile device and the HEOS app, you can setup, browse, explore, and control your HEOS system right in the palm of your hand, from anywhere in your home.

Download the HEOS app for iOS or Android by searching App Store®, Google Play™ store or Amazon for “HEOS”.



For the purpose of improvement, the specifications and design are subject to change without notice.



Setting up your first DHT-S716H

Once you have placed your DHT-S716H in your listening room and have downloaded the HEOS app, you are ready to configure your DHT-S716H for music playback. This involves following a few simple steps to get the DHT-S716H connected to your existing home network:

Caution

- DO NOT connect the Ethernet cable if you are connecting your DHT-S716H to a wireless network. If you are connecting the DHT-S716H to a wired network, use an Ethernet cable to connect the DHT-S716H to your network or router.

1 Make sure your mobile device is connected to your wireless network (the same network you want your DHT-S716H connected to).

You can check this in the Settings - Wi-Fi menu of your iOS or Android device.

NOTE

- If your wireless network is secure, make sure you know the password to join your network.

2 Make sure you have the included 1/8 inch (3.5 mm) setup cable handy.

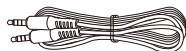

3 Launch the HEOS app on your mobile device.



4 Tap the “Setup Now” button at the top of the screen.

5 Follow the instructions to add the DHT-S716H to your wireless network.

The Wi-Fi settings from your mobile device will be copied to the DHT-S716H via the audio cable.

NOTE

- If you have any problems connecting your HEOS device, jump to the Troubleshooting section. (🔍 p. 63)



Adding more HEOS devices

The HEOS wireless multi-room sound system is a true multiroom audio system that automatically synchronizes audio playback between multiple HEOS devices so that the audio coming from different rooms is perfectly in sync and always sounds amazing! You can easily add up to 32 devices to your HEOS system.

Adding wired HEOS devices

Just connect the HEOS devices to your home network using an Ethernet cable and the HEOS devices will appear on your HEOS app as a new room in the “Rooms” screen.

At your convenience, you can assign a name to the HEOS devices to indicate which room you have it placed in.



- Use only a shielded STP or ScTP LAN cable which is easily available at electronics stores (CAT-5 or greater recommended).
- Do not connect a Network Connector directly to the LAN port/Ethernet connector on your computer.

Adding wireless HEOS devices

You can add additional wireless HEOS devices to your HEOS system by selecting “Add Device” from the HEOS app’s settings menu and follow the instructions:

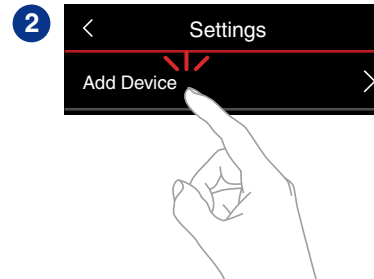
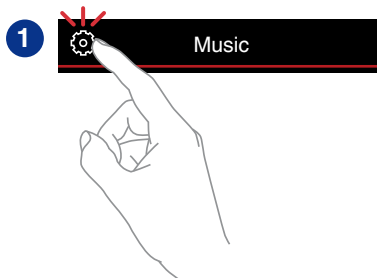

Connecting devices

When you run DHT-S716H for the first time, "Setup Assistant" will be started automatically to guide you setup connections.

You can start "Setup Assistant" anytime from setup menu, when you want to change the configurations. "Changing the TV connection" (👉 p. 57)

Connecting to your TV

■ HDMI connection

You can enjoy high quality audio and video playback by connecting this unit and a TV or this unit and a device such as a Blu-ray Disc recorder or game console using a HDMI cable to transmit high resolution digital video signals and Blu-ray Disc audio signals.

- ARC (Audio Return Channel) function

The TV audio can be played back through this unit using the HDMI cable used to connect this unit to the TV (*).

* The TV also needs to be compatible with the ARC function.

■ Setting the HDMI control function

Enable the HDMI control function on the TV.

If the TV is compatible with the ARC function, enable the ARC function on the TV.

(See the TV Owner's Manual for details.)



■ Disable your television's speakers

Disable your television's built-in speakers when using DHT-S716H. Usually, this is done with an on-screen setup menu on your television. Look for an "Audio" or "Sound" sub-menu, and a "Speakers Off", "Disable Speakers", "External Speakers" or similar menu item. Some televisions have a switch on the rear panel to disable the built-in speakers.

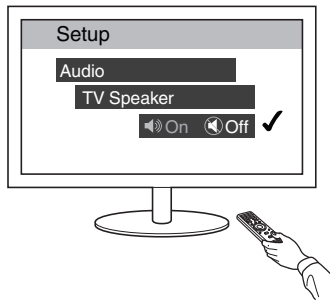

■ Playing HDMI (ARC) - Best choice

If your TV has an ARC (Audio Return Channel) HDMI connector, connect it to the HDMI output of the DHT-S716H. This will provide the best sound and several other benefits.

- 1** Connect your TV with an ARC (Audio Return Channel) HDMI connector to the HDMI OUT (ARC) connector on your DHT-S716H using the included HDMI cable.
- 2** Select “TV” from the music tab.
- 3** Select the name of the DHT-S716H to which you connected the TV in step 1.
- 4** The sound from your TV can be played directly on the DHT-S716H.

NOTE

- The TV also needs to be compatible with the ARC function.
Turn the TV HDMI control function on. See the TV Owner's Manual for details.
- To change the input automatically, you can set the default TV input in the setup menu. “Adjusting the TV input” (📖 p. 57)

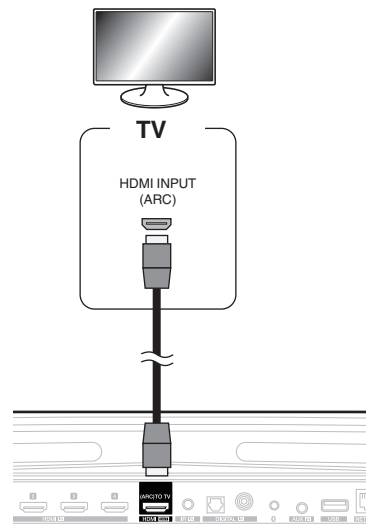

■ Playing HDMI (without ARC) - Better choice

Connect to a TV that is not compatible with the ARC (Audio Return Channel) function using the HDMI cable and audio input cable.

- 1 Connect your TV with an HDMI connector to HDMI OUT (ARC) connector on your DHT-S716H using the included HDMI cable.
- 2 Connect your TV to your DHT-S716H using either an included optical cable or a coaxial cable (not included).
- 3 Select “TV” from the music tab.
- 4 Select the name of the DHT-S716H to which you connected the TV in step 1 and 2.
- 5 The sound from your TV can be played directly on the DHT-S716H.

NOTE

- The TV audio cannot be played back on this unit when it is only connected with the HDMI cable.
- To change the input automatically, you can set the default TV input in the setup menu. “Adjusting the TV input” (🔧 p. 57)

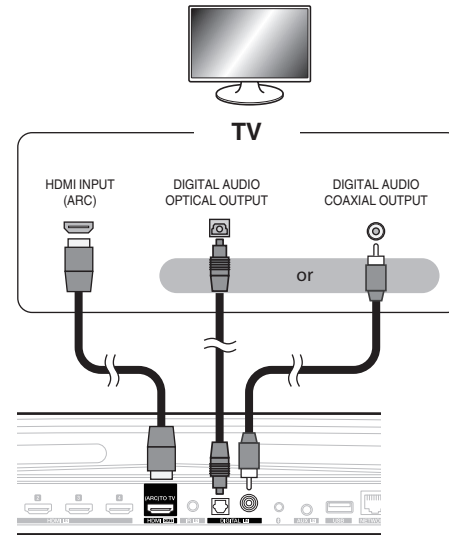

Connecting an other devices

■ Connecting to your HDMI equipment

You can play back from a device that has a HDMI terminal, such as a Blu-ray disc recorder or game console.

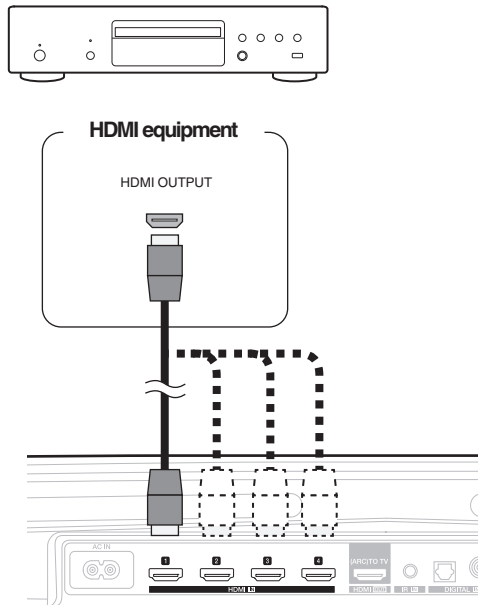

■ Connecting an audio playback device

Connect the COAXIAL IN, OPTICAL IN or AUX IN input to an audio playback device (CD player, portable music player, etc...) using the appropriate cables.

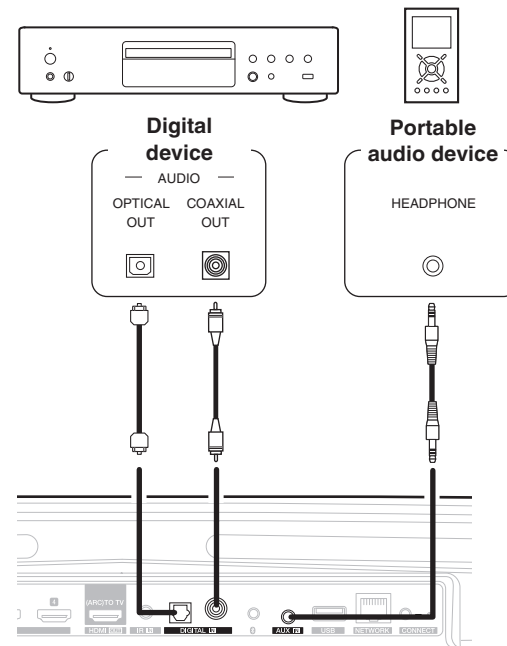

■ Connecting a USB storage device

Connect a FAT32 formatted USB storage device containing digital music files to any available USB port.

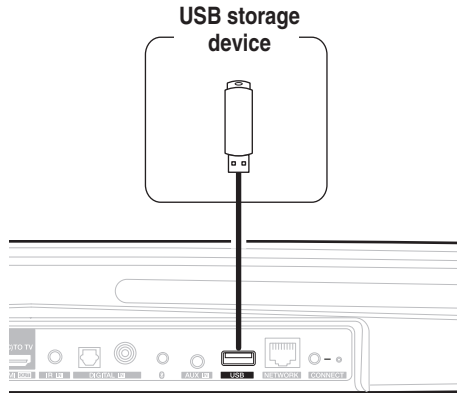

■ IR repeater

It can still be controlled by the remote control by connecting a remote control receiver unit (sold separately).

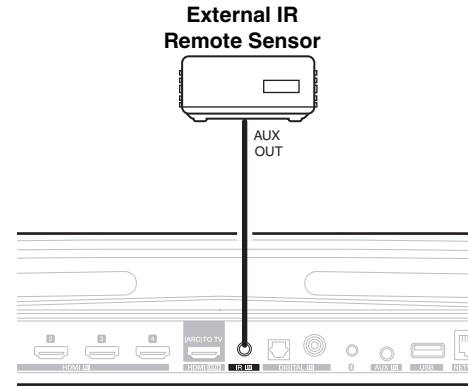

Pairing a DSW-1H and Surrounds

DHT-S716H can be used as a multi-channel system by pairing with HEOS speakers or our subwoofer DSW-1H (sold separately).

- 1 Select the Settings  icon located in the upper left corner of the main “Music” menu to display the Settings menu.**
- 2 Select “Denon DHT-S716H” from “My Devices”.**
- 3 Launch Setup Assistant.**
Setup assistant guides the DHT-S716H to pair.

NOTE

- A DSW-1H and surround speakers need to connect your wireless network before pairing.

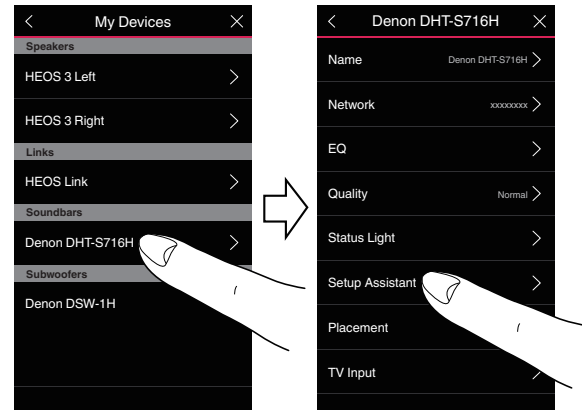

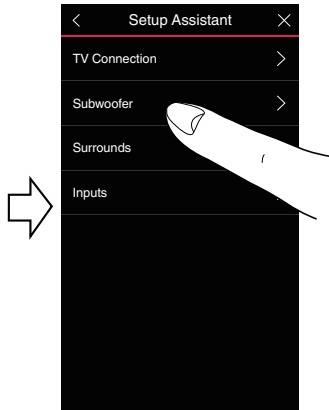

■ Pairing the DSW-1H

- 1 Select “Subwoofer”.
- 2 Select “Denon DSW-1H”, then tap NEXT.

NOTE

- Configure the DSW-1H settings after pairing is complete. Select “Optimized for DHT-S716H” for normal configuration. Settings are optimized for the DHT-S716H.

■ Adding surround speakers

- 1 Select “Surrounds”.
- 2 Select “Wireless HEOS Speakers” or “HEOS Amp” and tap NEXT.
Select the device that you want to add and tap NEXT.



■ Unpairing DSW-1H and Surrounds

- 1 Tap the pencil  icon in the upper right from the "Rooms" menu.
- 2 Select "Denon DHT-S716H".
- 3 Select the device that you want to disconnect from the list.

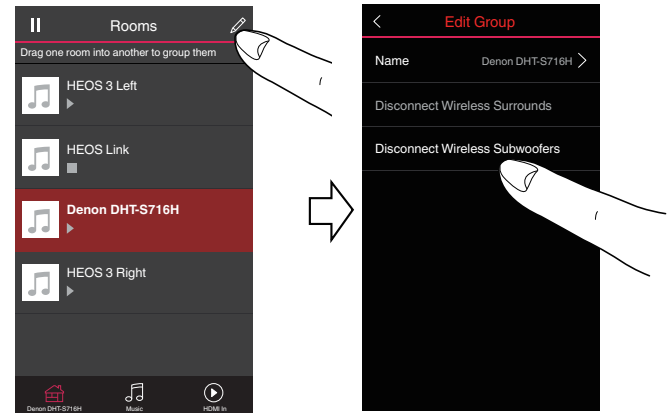

Using your DHT-S716H

Once you have your HEOS device connected to your network and the HEOS app installed on your mobile device, it's easy to start enjoying your favorite music. You can listen to something different in every room or the same music perfectly synchronized in all rooms. It's up to you!

HEOS account

■ What is a HEOS account?

A HEOS account is master account or “keychain” for managing all of your HEOS music services with one single username and password.

■ Why do I need a HEOS account?

With the HEOS account you just have to enter your music services login names and passwords one time. This allows you to easily and quickly use multiple controller apps on different devices. You just log into your HEOS account on any device and you will have access to all of your associated music services, play history and custom playlists, even if you are at a friend's house listening to music on their HEOS system.

■ Signing up for a HEOS account

You will be instructed to signup for a HEOS account the first time you try to access any music service from the main “Music” menu of the HEOS app.

Selecting a room/device

1 Tap the “Rooms” tab, and select DHT-S716H if there are multiple HEOS devices.



- Tap the pencil icon at the top right to switch edit mode. You can change the displayed name.

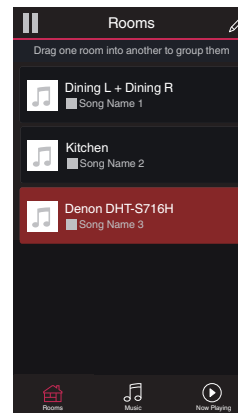

Listening to the same music in multiple rooms

The HEOS system is a true multiroom audio system that automatically synchronizes audio playback between multiple HEOS devices so that the audio coming from different rooms is perfectly in sync and always sounds amazing!

You can easily add up to 32 HEOS devices to your HEOS system.

You can join or group up to 16 individual HEOS devices into a group of HEOS devices that function as if they were a single HEOS device.

■ Grouping rooms

- 1** Press and hold your finger on room that is not playing music.
- 2** Drag it into the room that is playing music (indicated by the red outline) and lift your finger.

The two rooms will be grouped together into a single device group and both rooms will be playing the same music in perfect sync.



- When audio from the device connected to this unit is played back in a group, only 2-channel PCM input from the HDMI, digital or analog terminals can be played back.
- Grouping cannot be used when this unit is playing TV audio or external input audio. Enable “TV Sound Grouping” to use grouping. (🔗 p. 57)

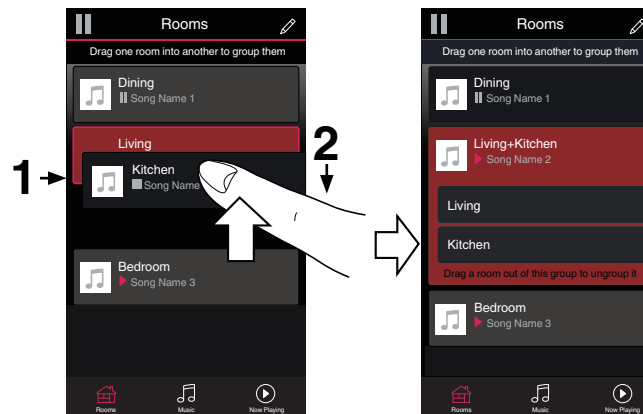

■ Ungrouping rooms

1 Press and hold your finger on room that you want to remove from the group.

2 Drag it out of the group and lift your finger.

Music will stop playing in the room you dragged out of the group but will continue playing in any remaining rooms.

NOTE

- You can not remove the first room that started playing the music before grouping.

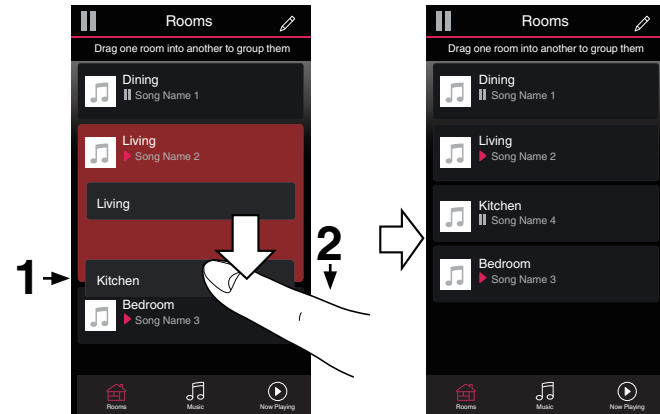

■ Grouping all rooms (party mode)

You can easily group 16 rooms together into Party Mode by using a “pinch” gesture.

1 Place two fingers on the screen over the list of rooms.

2 Quickly pinch your two fingers together and release.

All of your rooms will be joined together and begin playing the same music in perfect sync.



■ Ungrouping all rooms

You can easily ungroup all of your rooms and exit Party Mode by using a “spread” gesture.

- 1 Place two fingers close together on the screen over list of rooms.**
- 2 Quickly spread your two fingers apart from each other and release.**
All of your rooms will be ungrouped.



Selecting the music track or station from music sources

- 1 Tap the “Music” tab and select a music source.

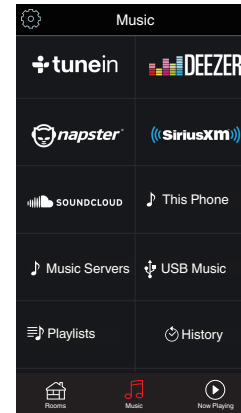

- All music services displayed may not be available in your location.



2 Browse the music to play.

After selecting a music track or radio station the app will automatically change to the “Now Playing” screen.



- When you select a music track to play you will be asked how you want to queue up your music.

Play Now:	Inserts the item into the queue after the currently playing track and plays the selected item immediately.
Play Now & Replace Queue:	Clears the queue and plays the selected item immediately.
Play Next:	Inserts the item into the queue after the current song and plays it when the current song ends.
Add to End of Queue:	Adds the item to the end of the queue.



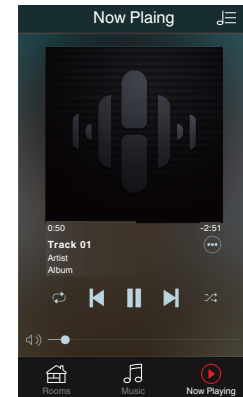
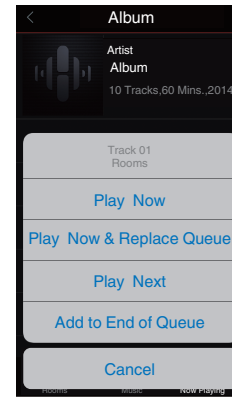

- When you select a radio station the following items are displayed.

Play Now:	Plays the selected item immediately.
Add to HEOS Favorites:	Adds to HEOS Favorites.





Rearranging the now playing queue

Once you have songs lined up in your queue, you might want to rearrange the order or remove some songs:

- 1 Tap the “Now Playing” tab.
- 2 Tap the Queue  icon in the upper right corner of the screen.
- 3 Tap the Pencil  icon to enter Edit mode.
- 4 Rearrange the order of your queue by dragging the list  icon (on the right side of each track row) up or down.

Deleting songs from the play queue



You can remove songs one at a time from the Now Playing Queue:

- 1 Tap the “Now Playing” tab.
- 2 Tap the Queue  icon in the upper right corner of the screen.
- 3 Tap the Pencil  icon to enter Edit mode.
- 4 Tap the track(s) that you want to delete.
- 5 Tap the Delete  icon to delete all of the selected tracks from the play queue.





Deleting all songs from the play queue

You can remove all of the songs from the Now Playing Queue:

- 1 Tap the “Now Playing” tab.
- 2 Tap the Queue  icon in the upper right corner of the screen.
- 3 Tap the Delete  icon to confirm that you want to delete all songs from the queue.

Saving playlists

You can save the Now Playing Queue as a HEOS Playlist that you can recall later. The new playlist will be available from the Playlists button on the “Music” tab on every controller app connected to your HEOS system.

- 1 Tap the “Now Playing” tab.
- 2 Tap the Queue  icon in the upper right corner of the screen.
- 3 Tap on the Save  icon.
- 4 Enter a name for your Playlist and tap the Save  icon.



Quick Select function

Input source, volume level and surround mode settings can be registered to the Quick select buttons (1 - 6).

- To register the current setting, point the remote control unit at this unit and then press and hold the Quick Select button you want to register (1-6) for 3 seconds.**



- The status LED on the main unit flashes once when registration is complete.
- You can also register using the HEOS app.
- You can change the Quick Select name of the HEOS app. (🔗 p. 58)

[Default settings]

Button/Default Name	Input Source	Volume	Sound Mode	Night Mode	Dialog Enhancer
Quick Select 1	HDMI 1	35	MOVIE	OFF	OFF
Quick Select 2	HDMI 2	35	MOVIE	OFF	OFF
Quick Select 3	HDMI 3	35	MOVIE	OFF	OFF
Quick Select 4	HDMI 4	35	MOVIE	OFF	OFF
Quick Select 5	HDMI ARC	35	MOVIE	OFF	OFF
Quick Select 6	OPT	35	MOVIE	OFF	OFF



Watching TV

1 Turn on the TV.

Automatically DHT-S716H changes the input to TV.



- If you can not hear the audio on DHT-S716H, please tap the "Inputs" in Music tab, then select the input which you want to enjoy.
- To change the input automatically, you can set the default TV input in the setup menu. "Adjusting the TV input" (🔧 p. 57)

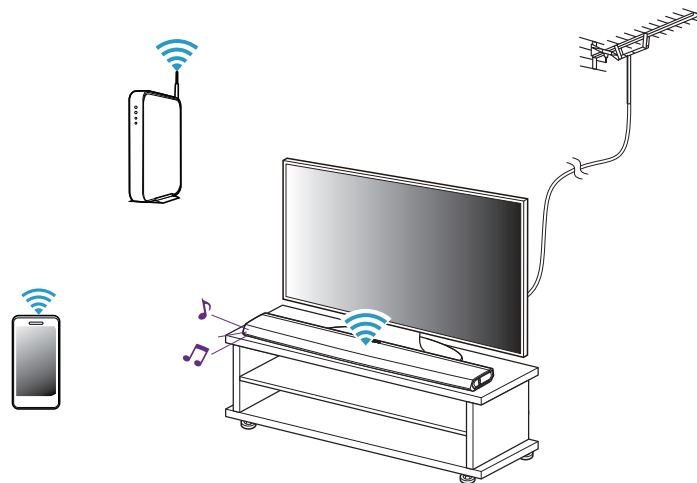

Watching other device

- 1 Turn on the TV.
- 2 Turn on the power of the HDMI device, such as a Blu-ray player or game console.

Automatically the input of the DHT-S716H switches to the HDMI device.



- If DHT-S716H does not switch the input automatically, please tap the "Inputs" in Music tab, then select the input which you want to enjoy.
- Set the HDMI control on the TV to On to enable automatic switching of the DHT-S716H input. (🔗 p. 26)

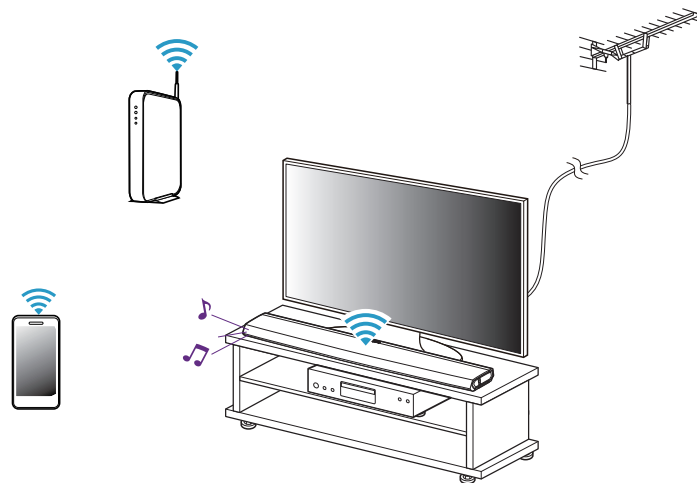

Listening to radio

The HEOS system includes access to more than 100,000 free internet radio streams from all corners of the globe via the TuneIn radio service. Just select the TuneIn logo from the main “Music” menu and browse among the 100,000 stations neatly organized into popular categories and select a station that appeals to your mood.

NOTE

- If you have a TuneIn account, you can sign into the TuneIn service under “Settings” - “Music Sources” - TuneIn, and access all of your “My Favorites” TuneIn stations.

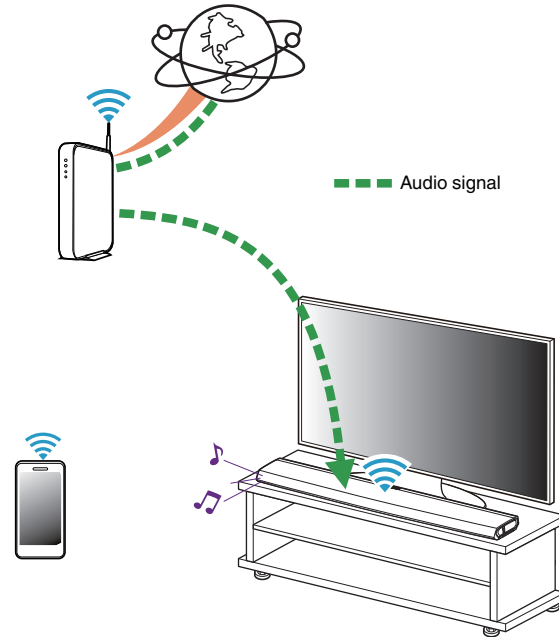

Playing music stored on your mobile device

- 1 Tap the “Music” tab.
- 2 Select “This iPhone/iPod/iPad/Phone”.
- 3 Browse the local music on your phone and select something to play.

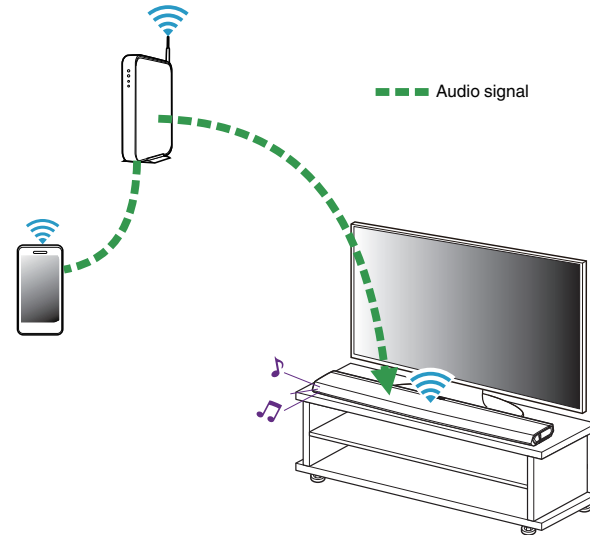

Playing music from your networked PC or NAS

- 1 Select “Music Servers” from the “Music” tab.
- 2 Select the name of your networked PC or NAS (Network Attached Storage) server.
- 3 Browse the music on your PC/NAS and select something to play.

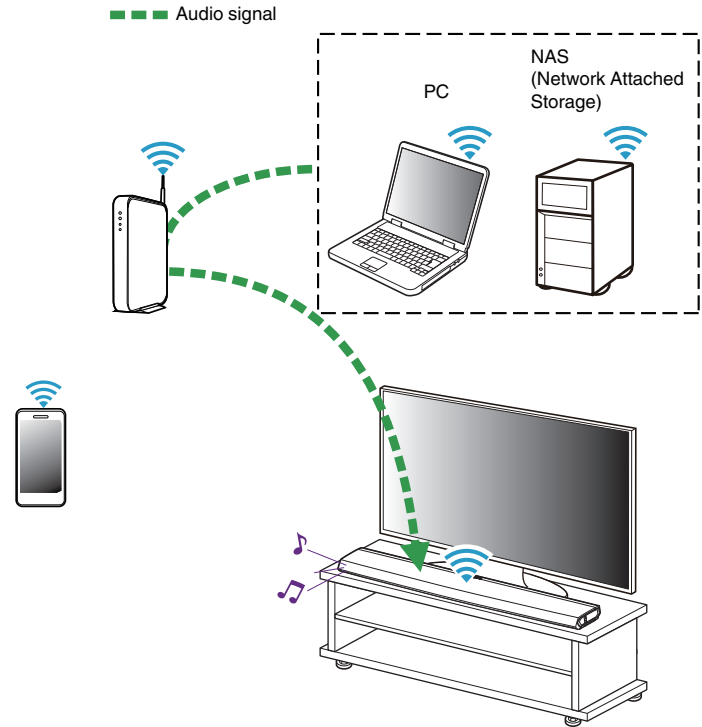

Streaming an external audio device to any HEOS device

The sound from the audio device can be played directly on the selected device or digitized and sent over your network to other HEOS devices.

- 1** Connect an external audio device to the digital optical, analog RCA stereo or analog 1/8 inch (3.5 mm) stereo inputs on the back of the DHT-S716H.
- 2** Select “Inputs” from the “Music” tab.
- 3** Select the name of the DHT-S716H and which input to which you connected the audio device in step 1.
- 4** Initiate playback on the audio device.

NOTE

- When a stereo audio cable is connected to AUX IN, the source automatically switches to Inputs.

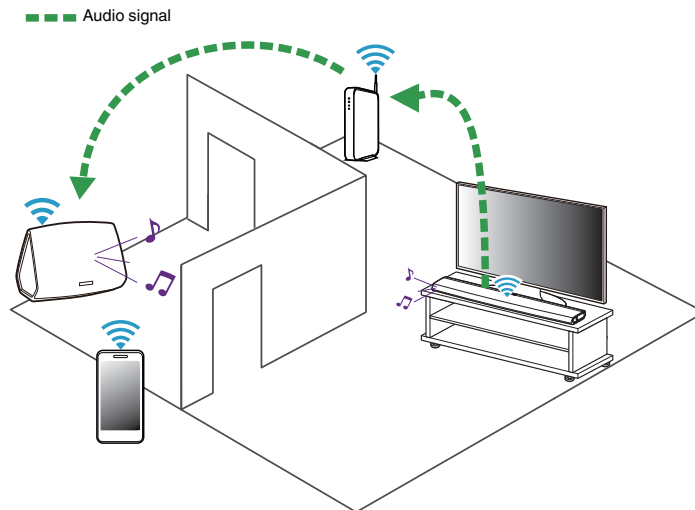

Playing music from a USB device

- 1** Insert a FAT32 formatted USB device into the USB port on the back of the DHT-S716H.
- 2** Select “USB Music” from the “Music” tab.
- 3** Select the name of your HEOS device.
- 4** Browse the music on your USB device and select something to play.

NOTE

- It may take several minutes for the name of your HEOS device to appear in the “USB Music” list if you have a large number of files on your USB device.
- It is not possible to connect and use a computer via the USB port of this unit using a USB cable.

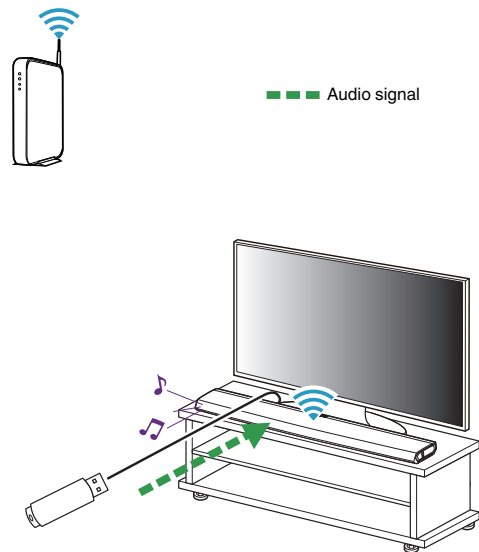

Playing music from Bluetooth device

■ Pairing the HEOS device with your Bluetooth devices

- 1 Activate the Bluetooth setting on your mobile device.
- 2 Press and hold the Play/Pause button located on the remote control unit for 3 seconds and release the button when you see a pattern of two green flashes on the status LED.
- 3 Select “DHT-S716H” from the list of available Bluetooth devices.
In a few seconds your mobile device will indicate that it is connected to your DHT-S716H.
- 4 Play music using any app on your device. The sound will now play from the DHT-S716H.

NOTE

- Disconnect and reconnect Bluetooth connections from your Bluetooth device.
- You can also pair devices by pressing and holding the Bluetooth button on the back of the DHT-S716H.

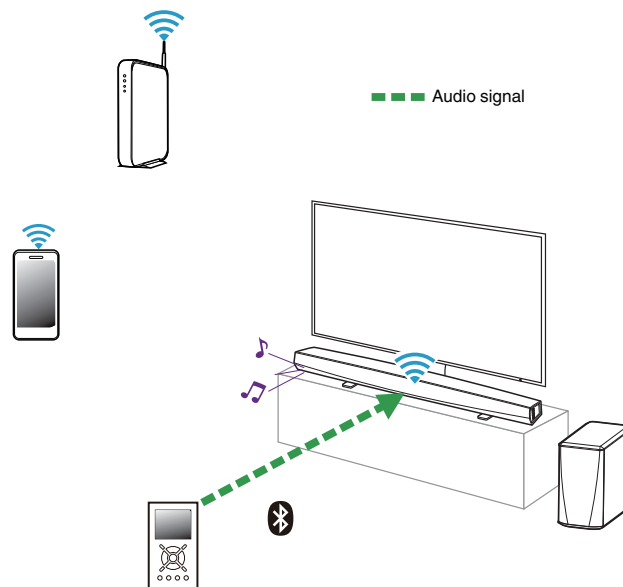

Playing from streaming music services

A music service is an online music company that provides access to vast music collections via free and/or paid subscriptions. Depending upon your geographical location, there are several options to choose from.

NOTE

- The HEOS app and brand is not affiliated with any manufacturer of any mobile device. Availability of music services may vary by region. Not all services may be available at time of purchase. Some services may be added or discontinued from time to time based on decisions of the music service providers or others.

■ Adding a music service

Once you've setup your HEOS account, you can add supported music services to your HEOS system by tapping on the music service logo in the "Music" tab.

Follow the instructions on the screen to add your username and password for the selected music service. You only have to enter your account information once as the HEOS account service will securely remember your login information so you don't have to enter it each time you want to play music from the music service.

Additional music services may be available under "Settings" - "Music Sources" - "Online Music".

■ Changing music service settings

- 1 Tap the "Music" tab.
- 2 Select the Settings  icon in the upper left corner of the screen.
- 3 Select "Music Sources".
- 4 Select "Online Music".
- 5 Select the name of the online music service you want to edit.
- 6 Sign out, then sign in again to associate your username and password with your HEOS account.
- 7 Select "Hide for Now" to prevent the service logo from appearing on the main "Music" menu.



Managing inputs

If you connected external audio source components to any of your HEOS devices inputs, you can rename the default input names to describe the actual source or hide any inputs that are not being used.

- 1** Select the **Settings**  icon located in the upper left corner of the main “Music” menu to display the Settings menu.
- 2** Select “Music Sources”.
- 3** Select “Inputs”.
- 4** Select the HEOS devices which you connect your external audio source device to.

■ Changing the name of the inputs

- 1** Select the name of the input you want to edit.
- 2** Select “Name”.
- 3** Select or enter a new name to describe the source that you connected.
- 4** Select the Save button to save your changes.

■ Hiding an input

- 1** Select the name of the input you want to edit.
- 2** Toggle “Hide Input” to ON to prevent this input from appearing under the Inputs tile on the main “Music” menu.



Managing your phone

Your smartphone or tablet can be hidden if it does not need to be in the "Music Sources" menu.

- 1** Select the **Settings**  icon located in the upper left corner of the main "Music" menu to display the Settings menu.
- 2** Select "Music Sources".
- 3** Select "This iPhone/iPod/iPad/Phone".
- 4** Toggle "This iPhone/iPod/iPad/Phone" to OFF to prevent the service logo from appearing on the main "Music" menu.

Using the favorite

HEOS uses a "HEOS Favorites" to line up station you want to start play quickly the favorite stations. Station can be selected from online music sources such as "Radio" or "Station" type streams. "HEOS Favorites" will display a list of the stations of various services.

■ Adding to HEOS favorite

Select a station of an online music source. When the action menu screen is displayed, select "Add Station to HEOS Favorites".

NOTE

- This can also be done by selecting "Add Station to HEOS Favorites" from the station menu of the station being played.

■ Deleting station from the HEOS favorite

- 1** Tap the "Music" tab.
- 2** Select "Favorites".
- 3** Tap the Pencil  icon to enter Edit mode.
- 4** Tap the "Delete" that you want to delete station.



Making adjustments

You can adjust specific settings for each of your HEOS device in your system:

- 1** Select the **Settings**  icon located in the upper left corner of the main “Music” menu to display the **Settings** menu.
- 2** Select “My Devices” to display a list of your HEOS devices.
- 3** Select the HEOS device you want to adjust.

Adjusting the audio quality

Selects the transcoding option for rebroadcasting audio from one HEOS device to another HEOS device (or group of devices) across the network. When set to high bit rate audio sources originating from the first device (such as Analog input, WAV, FLAC and PCM) will be transcoded to ensure the highest level of reliability for the audio stream. (👉 p. 50)

- 1** Select “Quality”.
- 2** Select “Normal” (default) or “High”.



- If you have selected High and you experience audio dropouts when streaming sources from one device to other devices, please select Normal (default).



Changing the TV connection

"Setup Assistant" can be re-executed when changing the TV connection.

1 Select "Setup Assistant".

2 Turn on your TV.

Select which input you want to use to connect your TV.

Adjusting the TV input

It will be able to automatically switch to TV mode once the TV is turned on.

1 Select "TV Input".

Default Input

Select the input to use when the TV tile is selected from the Music Tab.

Auto-Play

Enabled to automatically switch to the default input when a signal is detected on the default input line

TV Sound Grouping

Set when you want to play TV audio or external input audio from this unit through a different HEOS device.

1 Select "TV Sound Grouping".

Enable

Enables grouping.

Audio Delay

Sets the delay for the audio.

NOTE

- The audio may cut out if the amount of delay is too short. Lengthen the amount of delay if the audio cuts out.



Changing the name of Quick Select

- 1** Select "Quick Select Names".
- 2** Select or enter a new name to describe the registered Quick Select.
- 3** Tap the Save button to save your changes.

Adjusting the status light brightness

- 1** Select "Status Light".
Adjust the brightness up or down or set the slider to the OFF position to completely disable the status light.



Updating your system

HEOS has the ability to add enhancements and updated functionality via your high speed Internet connection. Follow the instructions on the screen to update the HEOS device and/or your controller App.

1 Select the **Settings**  icon located in the upper left corner of the main “Music” menu to display the **Settings** menu.

2 Select “**Software Update**”.

Check for Update

Follow the instructions on screen to install any available updates to your HEOS system.

Auto-Update

ON (Default):	Valid updates are performed automatically.
OFF:	You will be notified of valid updates on the HEOS app.



Advanced features

There are a few advanced features of the HEOS system that you may want to explore once you become familiar with the basic operations. You can access the advanced features of the HEOS system by following these steps:

- 1** Select the **Settings**  icon located in the upper left corner of the main “Music” menu to display the **Settings** menu.
- 2** Select “**Advanced Settings**” to display a list the available settings.

Wireless performance

You can check the wireless connection status of your HEOS device.

Quality

Excellent / Good / Poor

NOTE

- If the quality level of your HEOS device is “Poor”, make sure your HEOS devices are not located near other electronic devices that could interfere with its wireless connectivity (like microwave ovens, cordless phones, TVs, etc...)

Signal

Excellent / Good / Poor

NOTE

- If the signal level of your HEOS device is “Poor”, make sure your HEOS devices are within range of your wireless network.



Power management

Power modes

■ Quick Start Mode

HEOS device automatically enters "Quick Start Mode" to save power in the following cases. This unit will automatically resume to full power whenever the device is selected and playing music.

The status LED dims when the mode is switched to Quick Start Mode.

□ Ethernet

After around 20 minutes of no operation and no network access after playing music via Ethernet.

□ Wi-Fi

After around 20 minutes of no operation and no network access after playing music via Wi-Fi.

□ USB

After around 20 minutes of no operation and no network access after playing music from a USB memory device.

□ Bluetooth

After the Bluetooth connection is disconnected and there is around 20 minutes of no operation and no network access after playing music via Bluetooth.

□ AUX IN

After around 20 minutes of no operation after AUX cable is disconnected.

□ OPT IN

After around 20 minutes of no operation after optical device is put into standby.

□ COAX IN

After around 20 minutes of no operation after coaxial device is put into standby.

□ HDMI IN

Play the HDMI device, such as a Blu-ray player, connected to this unit. Around 20 minutes after HDMI device and TV are put into standby.

□ HDMI OUT (ARC)

Connect this unit and the ARC compatible TV with HDMI cable and play TV. Around 20 minutes after TV is put into standby.



- Press the Power button on the remote control unit to switch to Quick Start Mode.



■ Deep Standby

The device also has the ability to automatically enter “Deep Standby” whenever the wired and wireless network connections are removed for more than 60 minutes in Quick Start Mode. Status LED will turn off during Deep Standby.

To “wake” a HEOS device from Deep Standby, you must press the power button on the remote control unit which will immediately turn on status LED.

The Device may need to “find” the network before it can operate properly.

NOTE

- Please note that the HEOS cannot be operated as intended when in Deep Standby as there is no network connection.



- Press and hold the Power button on the remote control unit for more than 3 seconds to switch to Deep Standby.

■ Off

To completely turn off the power to the device you must remove the mains plug from the power outlet.



Basic troubleshooting

My HEOS device won't connect to my network using the audio cable

Solution	Refer to Page
<ul style="list-style-type: none"> Make sure your mobile device is connected to your wireless network before setting up your device. Alternatively, you can connect your device to your network router using the included Ethernet cable. Once connected via Ethernet, the HEOS App should recognize the device and you can manually move it to your wireless network using Settings/My Devices/Device_Name/Advanced/Network Settings. 	24 25

If the TV remote control does not work

Solution	Refer to Page
<ul style="list-style-type: none"> Remove any items that may block the transmission of signals between the TV and DHT-S716H. If the TV and DHT-S716H are too close, move the DHT-S716H more than 2 inches (50 mm) from the TV. 	31 —



Cannot pair a Bluetooth mobile device with the HEOS device

Solution	Refer to Page
<ul style="list-style-type: none"> The connection from the Bluetooth mobile device is malfunctioning. Power cycle the mobile device, remove the pairing information and re-pair the DHT-S716H to the mobile device. 	—

Cannot hear Bluetooth music

Solution	Refer to Page
<ul style="list-style-type: none"> Your Bluetooth mobile device is not paired with HEOS device. Re-pair the HEOS device to the mobile device. 	52
<ul style="list-style-type: none"> The HEOS device is Wi-Fi mode or Aux-in mode etc. Pair and connect Bluetooth device to HEOS device. 	—
<ul style="list-style-type: none"> The Bluetooth mobile device is connected to another audio device. Make sure your Bluetooth device is connected to HEOS device. 	—
<ul style="list-style-type: none"> The volume on Bluetooth mobile device is too low. Check the volume on the Bluetooth mobile device. Check the volume on the HEOS device. 	—



My HEOS device turns off and the status LED flashes in red

Solution	Refer to Page
<ul style="list-style-type: none"> The protection circuit has been activated due to a rise in temperature within your HEOS device. Turn the power off, wait about an hour until this device cools down sufficiently, and then turn the power on again. 	–

Music cuts out or delays sometimes

Solution	Refer to Page
<ul style="list-style-type: none"> Make sure your Internet connection is operating correctly. If you are sharing your network with other users or devices, they may be using most of your bandwidth (especially if they are streaming video). 	7
<ul style="list-style-type: none"> Make sure your HEOS devices are within range of your wireless network. 	60
<ul style="list-style-type: none"> Make sure your HEOS devices are not located near other electronic devices that could interfere with it's wireless connectivity (like microwave ovens, cordless phones, TVs, etc...). 	60

I hear a delay when using the external input with my TV

Solution	Refer to Page
<ul style="list-style-type: none"> If you are connecting the External input with your cable or satellite box for enjoying TV audio through multiple HEOS devices, you may hear a delay between when you see someone speak and when you hear the audio. This is because the HEOS system must buffer the audio before it sends it out to the HEOS devices so that it arrives at all devices at the same time. 	–
<ul style="list-style-type: none"> You can avoid this delay by listening only to the device which is directly connected to the set top box. 	–



I hear distortion when using the AUX input

Solution	Refer to Page
<ul style="list-style-type: none"> The analog output signals from some sources can be fairly strong. If the input level of the source device is turned up high, it could overload the inputs of the HEOS device. This is unlikely to cause damage, but can cause distorted sound. Initially, set the volume of the source to a medium – low level, then turn it up as needed. If you hear distortion, turn down the device's volume control. 	—

Connecting to a WPS network

Solution	Refer to Page
<ul style="list-style-type: none"> If your wireless router support WPS (Wi-Fi Protected Setup™) your HEOS wireless device can optionally connect to your network using the “Push Button” method by following these steps: Wi-Fi Protected Setup™ is trademarks of Wi-Fi Alliance. <ol style="list-style-type: none"> Press the WPS button on your router. Within 2 minutes, press and hold the Connect button on the rear panel of the HEOS device for 3 seconds. The LED on the front of the device will flash green for several seconds as it connects to your WPS router. When the connection is complete, the LED on the front of the device will turn solid blue. 	7









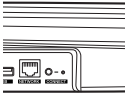

Resetting your HEOS device





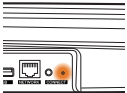

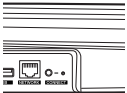
Solution	Refer to Page
<ul style="list-style-type: none">Resetting your HEOS device will clear out the wireless network info, EQ, and name but retain it's current software. You will have to use Settings - Add Device to reconnect the HEOS device to your home network before it can be used. To reset your HEOS device, press and hold the Connect and Bluetooth buttons located on the back of the HEOS device for 5 seconds until the front LED begins to flash amber.	-



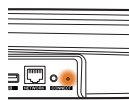

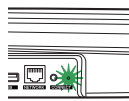

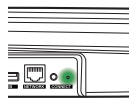

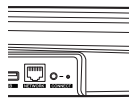

Status LED table

Device Operation	Description	Front LED Action	Rear LED Action
Off	No AC power or Deep Standby	 (off)	 (off)
Plug in	Booting	 (blink)	 (off)
On	Ready-Configured and connected to your network	 (solid)	 (off)
On	Not Connected to your network	 (solid)	 (solid)
Change Network	Connecting to your network	 (blink)	 (off)

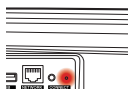



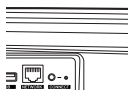

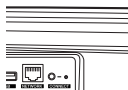

Device Operation	Description	Front LED Action	Rear LED Action
Setup	Not connected	 (solid)	 (solid)
	Connect button was pressed	 (blink)	 (blink)
	Cable connection is OK	 (solid)	 (solid)
	Connecting to your network	 (blink)	 (off)

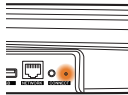

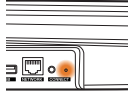

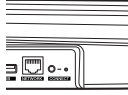

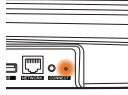
Device Operation	Description	Front LED Action	Rear LED Action
Setup	Configured and connected to your network	 (solid)	 (off)
	Error	 (solid)	 (solid)
Update	Updating	 (blink)	 (blink)
	Rebooting	 (blink)	 (off)
	Ready-Configured and connected to your network	 (solid)	 (off)



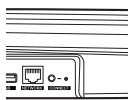

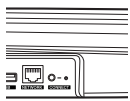

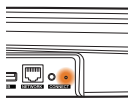

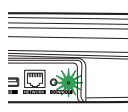

Device Operation	Description	Front LED Action	Rear LED Action
Reset	Soft reset - Clear user settings	 <p>(fast blink)</p>	 <p>(solid)</p>
	Hard reset - Factory restore	 <p>(blink)</p>	 <p>(solid)</p>
	Rebooting	 <p>(blink)</p>	 <p>(off)</p>
	Ready-Not Configured	 <p>(solid)</p>	 <p>(solid)</p>

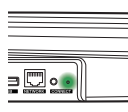

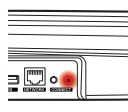

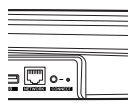

Device Operation	Description	Front LED Action	Rear LED Action
Errors	Firmware Error	 (slow blink (NOT fade))	 (off)
	Hardware Error	 (fast blink)	 (off)
	Network Error	 (solid)	 (solid)

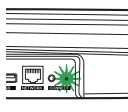

Device Operation	Description	Front LED Action	Rear LED Action
WPS	a WPS session is active	 (fast blink)	 (fast blink)
	WPS connected	 (for 3 sec. solid)	 (solid)
	WPS time-out	 (for 3 sec. solid)	 (solid)
Power Management	Quick Start Mode	 (dimmed solid)	 (off)
	Deep Standby	 (off)	 (off)

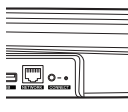

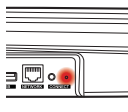
Device Operation	Description	Front LED Action	Rear LED Action
Bluetooth	Bluetooth pairing is active	 (two blinks)	 (two blinks)
	Connected (No Network)	 (one blink)	 (off)
	Bluetooth pairing is failed	 (for 3sec. solid)	 (for 3sec. solid)



Supported file types and codecs

Frequency	Sample Rate	File Extension	Codec	Bit Rates
32/44.1/48 88.2/96/176.4 192 kHz	16/24 bit	wav	PCM	---
32 kHz 44.1 kHz 48 kHz	16 bit	mp3	MPEG-1 Audio Layer 3 CBR/VBR	32 - 320 kbps
32 kHz 44.1 kHz 48 kHz	16 bit	m4a aac	AAC-LC	48 - 320 kbps
32 kHz 44.1 kHz 48 kHz	16 bit	wma	wma9 CBR	CBR:48 - 192 kbps
44.1/48 88.2/96/176.4 192 kHz	16/24 bit	flac	flac	---
44.1/48 88.2/96/176.4 192 kHz	16/24 bit	m4a	ALAC	---
2.8/5.6 MHz	1 bit	dff dsf	DSDIFF DSF	---

NOTE

- Files protected by DRM such as Apple's Fairplay DRM, are not supported.
- The ALAC decoder is distributed under the Apache License, Version 2.0 (<http://www.apache.org/licenses/LICENSE-2.0>)

Supported audio formats (Coaxial/Optical)

2-channel Linear PCM:2-channel, 32 kHz – 192 kHz, 16/20/24 bit



Specifications

■ Wireless LAN section

Network type:	Conforming to IEEE 802.11a/b/g/n/ac
Used frequency range:	2.4 GHz, 5 GHz

■ General

Operating temperature:	41 °F - 95 °F (5 °C - 35 °C)
Power supply:	AC 100 - 240 V, 50/60 Hz
Power consumption:	50 W
Power consumption in Quick Start Mode: *	4.9 W (Wi-Fi) 3.7 W (Ethernet) 4.1 W (USB) 3.7 W (Bluetooth) 4.3 W (HDMI IN) 3.8 W (HDMI OUT(ARC))
Power consumption in Deep Standby Mode: *	0.4 W

*Cable to AUX IN must be disconnected to enter Quick Start Mode and Deep Standby Mode.



■ Dimensions (Unit : in. (mm))

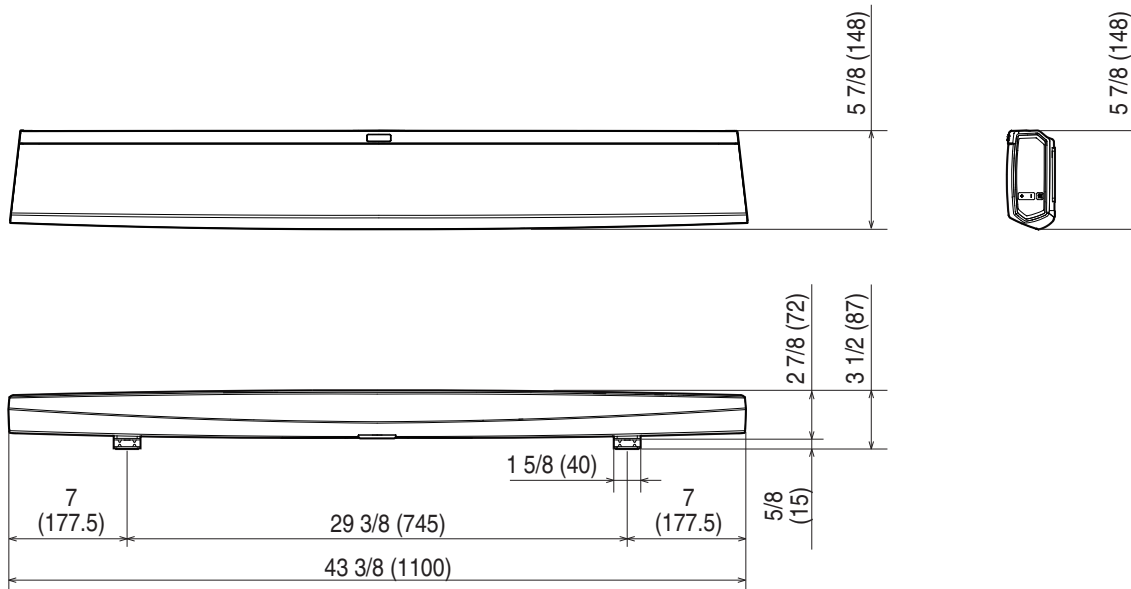

■ Weight : 10 lbs 9 oz (4.8 kg)

For the purpose of improvement, the specifications and design are subject to change without notice.



Information

Trademarks



Manufactured under license from Dolby Laboratories. Dolby, Dolby Audio, Pro Logic, and the double-D symbol are trademarks of Dolby Laboratories.



For DTS patents, see <http://patents.dts.com>. Manufactured under license from DTS Licensing Limited. DTS, DTS-HD, the Symbol, & DTS and the Symbol together are registered trademarks of DTS, Inc. © DTS, Inc. All Rights Reserved.



The terms HDMI, HDMI High-Definition Multimedia Interface, and the HDMI Logo are trademarks or registered trademarks of HDMI Licensing Administrator, Inc.



Google Play and the Google Play logo are trademarks of Google LLC.



Apple, the Apple logo, iPad, iPhone, and iPod touch are trademarks of Apple Inc., registered in the U.S. and other countries. App Store is a service mark of Apple Inc.



Amazon, Kindle, Echo, Alexa, Dash, Fire and all related logos are trademarks of Amazon.com, Inc. or its affiliates.





The Bluetooth® word mark and logos are registered trademarks owned by the Bluetooth SIG, Inc. and any use of such marks by D&M Holdings Inc. is under license. Other trademarks and trade names are those of their respective owners.



License

■ License information for the software used in the unit

About GPL (GNU-General Public License), LGPL (GNU Lesser General Public License) License

This product uses GPL/LGPL software and software made by other companies.

After you purchase this product, you may procure, modify or distribute the source code of the GPL/LGPL software that is used in the product.

Denon provides the source code based on the GPL and LGPL licenses at the actual cost upon your request to our customer service center. However, note that we make no guarantees concerning the source code. Please also understand that we do not offer support for the contents of the source code.

This section describes software license used for this unit. To maintain the correct content, the original (English) is used.

□ GPL

Open Source Used	Version
bridge-utils	2.8
busybox	1.21.1
ebtables	2.0.10-4
Linux kernel	3.10.74
mtd-utils	1.4.3
ntfs-3g_ntfsprogs	2011.4.12
ntpclient	2007
u-boot	2015.01
wireless-tools	version 29

□ LGPL

Open Source Used	Version
ffmpeg	0.8.3
glibc	2.9
libmms	0.6.2

□ curl-7.24.0

COPYRIGHT AND PERMISSION NOTICE

Copyright (c) 1996 - 2014, Daniel Stenberg, <daniel@haxx.se>

All rights reserved.

Permission to use, copy, modify, and distribute this software for any purpose with or without fee is hereby granted, provided that the above copyright notice and this permission notice appear in all copies.

THE SOFTWARE IS PROVIDED "AS IS", WITHOUT WARRANTY OF ANY KIND, EXPRESS OR IMPLIED, INCLUDING BUT NOT LIMITED TO THE WARRANTIES OF MERCHANTABILITY, FITNESS FOR A PARTICULAR PURPOSE AND NONINFRINGEMENT OF THIRD PARTY RIGHTS. IN NO EVENT SHALL THE AUTHORS OR COPYRIGHT HOLDERS BE LIABLE FOR ANY CLAIM, DAMAGES OR OTHER LIABILITY, WHETHER IN AN ACTION OF CONTRACT, TORT OR OTHERWISE, ARISING FROM, OUT OF OR IN CONNECTION WITH THE SOFTWARE OR THE USE OR OTHER DEALINGS IN THE SOFTWARE.

Except as contained in this notice, the name of a copyright holder shall not be used in advertising or otherwise to promote the sale, use or other dealings in this Software without prior written authorization of the copyright holder.



❑ e2fsprogs-libs-1.40.8/lib/uuid

Redistribution and use in source and binary forms, with or without modification, are permitted provided that the following conditions are met:

1. Redistributions of source code must retain the above copyright notice, and the entire permission notice in its entirety, including the disclaimer of warranties.
2. Redistributions in binary form must reproduce the above copyright notice, this list of conditions and the following disclaimer in the documentation and/or other materials provided with the distribution.
3. The name of the author may not be used to endorse or promote products derived from this software without specific prior written permission.

THIS SOFTWARE IS PROVIDED "AS IS" AND ANY EXPRESS OR IMPLIED WARRANTIES, INCLUDING, BUT NOT LIMITED TO, THE IMPLIED WARRANTIES OF MERCHANTABILITY AND FITNESS FOR A PARTICULAR PURPOSE, ALL OF WHICH ARE HEREBY DISCLAIMED. IN NO EVENT SHALL THE AUTHOR BE LIABLE FOR ANY DIRECT, INDIRECT, INCIDENTAL, SPECIAL, EXEMPLARY, OR CONSEQUENTIAL DAMAGES (INCLUDING, BUT NOT LIMITED TO, PROCUREMENT OF SUBSTITUTE GOODS OR SERVICES; LOSS OF USE, DATA, OR PROFITS; OR BUSINESS INTERRUPTION) HOWEVER CAUSED AND ON ANY THEORY OF LIABILITY, WHETHER IN CONTRACT, STRICT LIABILITY, OR TORT (INCLUDING NEGLIGENCE OR OTHERWISE) ARISING IN ANY WAY OUT OF THE USE OF THIS SOFTWARE, EVEN IF NOT ADVISED OF THE POSSIBILITY OF SUCH DAMAGE.

❑ expat-2.0.1

Copyright (c) 1998, 1999, 2000 Thai Open Source Software Center Ltd and Clark Cooper

Copyright (c) 2001, 2002, 2003, 2004, 2005, 2006 Expat maintainers.

Permission is hereby granted, free of charge, to any person obtaining a copy of this software and associated documentation files (the "Software"), to deal in the Software without restriction, including without limitation the rights to use, copy, modify, merge, publish, distribute, sublicense, and/or sell copies of the Software, and to permit persons to whom the Software is furnished to do so, subject to the following conditions:

The above copyright notice and this permission notice shall be included in all copies or substantial portions of the Software.

THE SOFTWARE IS PROVIDED "AS IS", WITHOUT WARRANTY OF ANY KIND, EXPRESS OR IMPLIED, INCLUDING BUT NOT LIMITED TO THE WARRANTIES OF MERCHANTABILITY, FITNESS FOR A PARTICULAR PURPOSE AND NONINFRINGEMENT.

IN NO EVENT SHALL THE AUTHORS OR COPYRIGHT HOLDERS BE LIABLE FOR ANY CLAIM, DAMAGES OR OTHER LIABILITY, WHETHER IN AN ACTION OF CONTRACT, TORT OR OTHERWISE, ARISING FROM, OUT OF OR IN CONNECTION WITH THE SOFTWARE OR THE USE OR OTHER DEALINGS IN THE SOFTWARE.



❑ getopt

<http://cvsweb.netbsd.org/bsdweb.cgi/src/lib/libc/stdlib/>

Copyright (c) 1987, 1993, 1994 The Regents of the University of California. All rights reserved.

Redistribution and use in source and binary forms, with or without modification, are permitted provided that the following conditions are met:

1. Redistributions of source code must retain the above copyright notice, this list of conditions and the following disclaimer.
2. Redistributions in binary form must reproduce the above copyright notice, this list of conditions and the following disclaimer in the documentation and/or other materials provided with the distribution.
3. Neither the name of the University nor the names of its contributors may be used to endorse or promote products derived from this software without specific prior written permission.

THIS SOFTWARE IS PROVIDED BY THE REGENTS AND CONTRIBUTORS "AS IS" AND ANY EXPRESS OR IMPLIED WARRANTIES, INCLUDING, BUT NOT LIMITED TO, THE IMPLIED WARRANTIES OF MERCHANTABILITY AND FITNESS FOR A PARTICULAR PURPOSE ARE DISCLAIMED. IN NO EVENT SHALL THE REGENTS OR CONTRIBUTORS BE LIABLE FOR ANY DIRECT, INDIRECT, INCIDENTAL, SPECIAL, EXEMPLARY, OR CONSEQUENTIAL DAMAGES (INCLUDING, BUT NOT LIMITED TO, PROCUREMENT OF SUBSTITUTE GOODS OR SERVICES; LOSS OF USE, DATA, OR PROFITS; OR BUSINESS INTERRUPTION) HOWEVER CAUSED AND ON ANY THEORY OF LIABILITY, WHETHER IN CONTRACT, STRICT LIABILITY, OR TORT (INCLUDING NEGLIGENCE OR OTHERWISE) ARISING IN ANY WAY OUT OF THE USE OF THIS SOFTWARE, EVEN IF ADVISED OF THE POSSIBILITY OF SUCH DAMAGE.

❑ jQuery

Copyright 2014 jQuery Foundation and other contributors

<http://jquery.com/>

Permission is hereby granted, free of charge, to any person obtaining a copy of this software and associated documentation files (the "Software"), to deal in the Software without restriction, including without limitation the rights to use, copy, modify, merge, publish, distribute, sublicense, and/or sell copies of the Software, and to permit persons to whom the Software is furnished to do so, subject to the following conditions:

The above copyright notice and this permission notice shall be included in all copies or substantial portions of the Software.

THE SOFTWARE IS PROVIDED "AS IS", WITHOUT WARRANTY OF ANY KIND, EXPRESS OR IMPLIED, INCLUDING BUT NOT LIMITED TO THE WARRANTIES OF MERCHANTABILITY, FITNESS FOR A PARTICULAR PURPOSE AND NONINFRINGEMENT. IN NO EVENT SHALL THE AUTHORS OR COPYRIGHT HOLDERS BE LIABLE FOR ANY CLAIM, DAMAGES OR OTHER LIABILITY, WHETHER IN AN ACTION OF CONTRACT, TORT OR OTHERWISE, ARISING FROM, OUT OF OR IN CONNECTION WITH THE SOFTWARE OR THE USE OR OTHER DEALINGS IN THE SOFTWARE.



❑ libpcap-1.4.0

License: BSD

Redistribution and use in source and binary forms, with or without modification, are permitted provided that the following conditions are met:

1. Redistributions of source code must retain the above copyright notice, this list of conditions and the following disclaimer.
2. Redistributions in binary form must reproduce the above copyright notice, this list of conditions and the following disclaimer in the documentation and/or other materials provided with the distribution.
3. The names of the authors may not be used to endorse or promote products derived from this software without specific prior written permission.

THIS SOFTWARE IS PROVIDED "AS IS" AND WITHOUT ANY EXPRESS OR IMPLIED WARRANTIES, INCLUDING, WITHOUT LIMITATION, THE IMPLIED WARRANTIES OF MERCHANTABILITY AND FITNESS FOR A PARTICULAR PURPOSE.

❑ libtar-1.2.11

Copyright (c) 1998-2003 University of Illinois Board of Trustees

Copyright (c) 1998-2003 Mark D. Roth

All rights reserved.

Developed by: Campus Information Technologies and Educational Services, University of Illinois at Urbana-Champaign

Permission is hereby granted, free of charge, to any person obtaining a copy of this software and associated documentation files (the "Software"), to deal with the Software without restriction, including without limitation the rights to use, copy, modify, merge, publish, distribute, sublicense, and/or sell copies of the Software, and to permit persons to whom the Software is furnished to do so, subject to the following conditions:

- * Redistributions of source code must retain the above copyright notice, this list of conditions and the following disclaimers.
- * Redistributions in binary form must reproduce the above copyright notice, this list of conditions and the following disclaimers in the documentation and/or other materials provided with the distribution.
- * Neither the names of Campus Information Technologies and Educational Services, University of Illinois at Urbana-Champaign, nor the names of its contributors may be used to endorse or promote products derived from this Software without specific prior written permission.

THE SOFTWARE IS PROVIDED "AS IS", WITHOUT WARRANTY OF ANY KIND, EXPRESS OR IMPLIED, INCLUDING BUT NOT LIMITED TO THE WARRANTIES OF MERCHANTABILITY, FITNESS FOR A PARTICULAR PURPOSE AND NONINFRINGEMENT.

IN NO EVENT SHALL THE CONTRIBUTORS OR COPYRIGHT HOLDERS BE LIABLE FOR ANY CLAIM, DAMAGES OR OTHER LIABILITY, WHETHER IN AN ACTION OF CONTRACT, TORT OR OTHERWISE, ARISING FROM, OUT OF OR IN CONNECTION WITH THE SOFTWARE OR THE USE OR OTHER DEALINGS WITH THE SOFTWARE.



❑ mDNS 320.10.80

The majority of the source code in the mDNSResponder project is licensed under the terms of the Apache License, Version 2.0, available from:

<<http://www.apache.org/licenses/LICENSE-2.0>>

To accommodate license compatibility with the widest possible range of client code licenses, the shared library code, which is linked at runtime into the same address space as the client using it, is licensed under the terms of the "Three-Clause BSD License".

The Linux Name Service Switch code, contributed by National ICT Australia Ltd (NICTA) is licensed under the terms of the NICTA Public Software Licence (which is substantially similar to the "Three-Clause BSD License", with some additional language pertaining to Australian law).

❑ mongoose

<https://github.com/cesanta/mongoose/>

Copyright (c) 2004-2013 Sergey Lyubka

Permission is hereby granted, free of charge, to any person obtaining a copy of this software and associated documentation files (the "Software"), to deal in the Software without restriction, including without limitation the rights to use, copy, modify, merge, publish, distribute, sublicense, and/or sell copies of the Software, and to permit persons to whom the Software is furnished to do so, subject to the following conditions:

The above copyright notice and this permission notice shall be included in all copies or substantial portions of the Software.

THE SOFTWARE IS PROVIDED "AS IS", WITHOUT WARRANTY OF ANY KIND, EXPRESS OR IMPLIED, INCLUDING BUT NOT LIMITED TO THE WARRANTIES OF MERCHANTABILITY, FITNESS FOR A PARTICULAR PURPOSE AND NONINFRINGEMENT. IN NO EVENT SHALL THE AUTHORS OR COPYRIGHT HOLDERS BE LIABLE FOR ANY CLAIM, DAMAGES OR OTHER LIABILITY, WHETHER IN AN ACTION OF CONTRACT, TORT OR OTHERWISE, ARISING FROM, OUT OF OR IN CONNECTION WITH THE SOFTWARE OR THE USE OR OTHER DEALINGS IN THE SOFTWARE.



❑ openssl-1.0.0d

Copyright (c) 1998-2011 The OpenSSL Project. All rights reserved.

Redistribution and use in source and binary forms, with or without modification, are permitted provided that the following conditions are met:

1. Redistributions of source code must retain the above copyright notice, this list of conditions and the following disclaimer.
2. Redistributions in binary form must reproduce the above copyright notice, this list of conditions and the following disclaimer in the documentation and/or other materials provided with the distribution.
3. All advertising materials mentioning features or use of this software must display the following acknowledgment:
"This product includes software developed by the OpenSSL Project for use in the OpenSSL Toolkit. (<http://www.openssl.org/>)"
4. The names "OpenSSL Toolkit" and "OpenSSL Project" must not be used to endorse or promote products derived from this software without prior written permission. For written permission, please contact openssl-core@openssl.org.
5. Products derived from this software may not be called "OpenSSL" nor may "OpenSSL" appear in their names without prior written permission of the OpenSSL Project.
6. Redistributions of any form whatsoever must retain the following acknowledgment:
"This product includes software developed by the OpenSSL Project for use in the OpenSSL Toolkit (<http://www.openssl.org/>)"

THIS SOFTWARE IS PROVIDED BY THE OpenSSL PROJECT "AS IS" AND ANY EXPRESSED OR IMPLIED WARRANTIES, INCLUDING, BUT NOT LIMITED TO, THE IMPLIED WARRANTIES OF MERCHANTABILITY AND FITNESS FOR A PARTICULAR PURPOSE ARE DISCLAIMED. IN NO EVENT SHALL THE OpenSSL PROJECT OR ITS CONTRIBUTORS BE LIABLE FOR ANY DIRECT, INDIRECT, INCIDENTAL, SPECIAL, EXEMPLARY, OR CONSEQUENTIAL DAMAGES (INCLUDING, BUT NOT LIMITED TO, PROCUREMENT OF SUBSTITUTE GOODS OR SERVICES; LOSS OF USE, DATA, OR PROFITS; OR BUSINESS INTERRUPTION) HOWEVER CAUSED AND ON ANY THEORY OF LIABILITY, WHETHER IN CONTRACT, STRICT LIABILITY, OR TORT (INCLUDING NEGLIGENCE OR OTHERWISE) ARISING IN ANY WAY OUT OF THE USE OF THIS SOFTWARE, EVEN IF ADVISED OF THE POSSIBILITY OF SUCH DAMAGE.

This product includes cryptographic software written by Eric Young (eay@cryptsoft.com). This product includes software written by Tim Hudson (tjh@cryptsoft.com).



❑ portmap-6.0

Copyright (c) 1990 The Regents of the University of California.

* All rights reserved.

* Redistribution and use in source and binary forms, with or without modification, are permitted provided that the following conditions are met:

1. Redistributions of source code must retain the above copyright notice, this list of conditions and the following disclaimer.
2. Redistributions in binary form must reproduce the above copyright notice, this list of conditions and the following disclaimer in the documentation and/or other materials provided with the distribution.
3. A ll advertising materials mentioning features or use of this software must display the following acknowledgement:
This product includes software developed by the University of California, Berkeley and its contributors.
4. Neither the name of the University nor the names of its contributors may be used to endorse or promote products derived from this software without specific prior written permission.

* THIS SOFTWARE IS PROVIDED BY THE REGENTS AND CONTRIBUTORS "AS IS" AND ANY EXPRESS OR IMPLIED WARRANTIES, INCLUDING, BUT NOT LIMITED TO, THE IMPLIED WARRANTIES OF MERCHANTABILITY AND FITNESS FOR A PARTICULAR PURPOSE ARE DISCLAIMED. IN NO EVENT SHALL THE REGENTS OR CONTRIBUTORS BE LIABLE FOR ANY DIRECT, INDIRECT, INCIDENTAL, SPECIAL, EXEMPLARY, OR CONSEQUENTIAL DAMAGES (INCLUDING, BUT NOT LIMITED TO, PROCUREMENT OF SUBSTITUTE GOODS OR SERVICES; LOSS OF USE, DATA, OR PROFITS; OR BUSINESS INTERRUPTION) HOWEVER CAUSED AND ON ANY THEORY OF LIABILITY, WHETHER IN CONTRACT, STRICT LIABILITY, OR TORT (INCLUDING NEGLIGENCE OR OTHERWISE) ARISING IN ANY WAY OUT OF THE USE OF THIS SOFTWARE, EVEN IF ADVISED OF THE POSSIBILITY OF SUCH DAMAGE.

❑ pstdint.h-0.1.12

* BSD License:

* Copyright (c) 2005-2011 Paul Hsieh

* All rights reserved.

* Redistribution and use in source and binary forms, with or without modification, are permitted provided that the following conditions are met:

1. Redistributions of source code must retain the above copyright notice, this list of conditions and the following disclaimer.
2. Redistributions in binary form must reproduce the above copyright notice, this list of conditions and the following disclaimer in the documentation and/or other materials provided with the distribution.
3. The name of the author may not be used to endorse or promote products derived from this software without specific prior written permission.

* THIS SOFTWARE IS PROVIDED BY THE AUTHOR "AS IS" AND ANY EXPRESS OR IMPLIED WARRANTIES, INCLUDING, BUT NOT LIMITED TO, THE IMPLIED WARRANTIES OF MERCHANTABILITY AND FITNESS FOR A PARTICULAR PURPOSE ARE DISCLAIMED.

* IN NO EVENT SHALL THE AUTHOR BE LIABLE FOR ANY DIRECT, INDIRECT, INCIDENTAL, SPECIAL, EXEMPLARY, OR CONSEQUENTIAL DAMAGES (INCLUDING, BUT NOT LIMITED TO, PROCUREMENT OF SUBSTITUTE GOODS OR SERVICES; LOSS OF USE, DATA, OR PROFITS; OR BUSINESS INTERRUPTION) HOWEVER CAUSED AND ON ANY THEORY OF LIABILITY, WHETHER IN CONTRACT, STRICT LIABILITY, OR TORT (INCLUDING NEGLIGENCE OR OTHERWISE) ARISING IN ANY WAY OUT OF THE USE OF THIS SOFTWARE, EVEN IF ADVISED OF THE POSSIBILITY OF SUCH DAMAGE.



❑ **rl78flash 2000.3.1**

License

=====

The MIT License (MIT)

Copyright (c) 2012 Maxim Salov

Permission is hereby granted, free of charge, to any person obtaining a copy of this software and associated documentation files (the "Software"), to deal in the Software without restriction, including without limitation the rights to use, copy, modify, merge, publish, distribute, sublicense, and/or sell copies of the Software, and to permit persons to whom the Software is furnished to do so, subject to the following conditions:

The above copyright notice and this permission notice shall be included in all copies or substantial portions of the Software.

THE SOFTWARE IS PROVIDED "AS IS", WITHOUT WARRANTY OF ANY KIND, EXPRESS OR IMPLIED, INCLUDING BUT NOT LIMITED TO THE WARRANTIES OF MERCHANTABILITY, FITNESS FOR A PARTICULAR PURPOSE AND NONINFRINGEMENT. IN NO EVENT SHALL THE AUTHORS OR COPYRIGHT HOLDERS BE LIABLE FOR ANY CLAIM, DAMAGES OR OTHER LIABILITY, WHETHER IN AN ACTION OF CONTRACT, TORT OR OTHERWISE, ARISING FROM, OUT OF OR IN CONNECTION WITH THE SOFTWARE OR THE USE OR OTHER DEALINGS IN THE SOFTWARE.

❑ **sqlite 2003.5.7**

SQLite Copyright

SQLite is in the
Public Domain

All of the code and documentation in SQLite has been dedicated to the public domain by the authors. All code authors, and representatives of the companies they work for, have signed affidavits dedicating their contributions to the public domain and originals of those signed affidavits are stored in a firesafe at the main offices of Hwaci. Anyone is free to copy, modify, publish, use, compile, sell, or distribute the original SQLite code, either in source code form or as a compiled binary, for any purpose, commercial or non-commercial, and by any means.

The previous paragraph applies to the deliverable code and documentation in SQLite - those parts of the SQLite library that you actually bundle and ship with a larger application. Some scripts used as part of the build process (for example the "configure" scripts generated by autoconf) might fall under other open-source licenses. Nothing from these build scripts ever reaches the final deliverable SQLite library, however, and so the licenses associated with those scripts should not be a factor in assessing your rights to copy and use the SQLite library.

All of the deliverable code in SQLite has been written from scratch. No code has been taken from other projects or from the open internet. Every line of code can be traced back to its original author, and all of those authors have public domain dedications on file. So the SQLite code base is clean and is uncontaminated with licensed code from other projects.



❑ **strncpy.c , v1.11**

- * Copyright (c) 1998 Todd C. Miller <Todd.Miller@courtesan.com>
- * Permission to use, copy, modify, and distribute this software for any purpose with or without fee is hereby granted, provided that the above copyright notice and this permission notice appear in all copies.
- * THE SOFTWARE IS PROVIDED "AS IS" AND THE AUTHOR DISCLAIMS ALL WARRANTIES WITH REGARD TO THIS SOFTWARE INCLUDING ALL IMPLIED WARRANTIES OF MERCHANTABILITY AND FITNESS. IN NO EVENT SHALL THE AUTHOR BE LIABLE FOR ANY SPECIAL, DIRECT, INDIRECT, OR CONSEQUENTIAL DAMAGES OR ANY DAMAGES WHATSOEVER RESULTING FROM LOSS OF USE, DATA OR PROFITS, WHETHER IN AN ACTION OF CONTRACT, NEGLIGENCE OR OTHER TORTIOUS ACTION, ARISING OUT OF OR IN CONNECTION WITH THE USE OR PERFORMANCE OF THIS SOFTWARE.

❑ **taglib-1.5**

copyright : (C) 2002 - 2008 by Scott Wheeler
email : wheeler@kde.org

"The contents of this file are subject to the Mozilla Public License Version 1.1 (the "License"); you may not use this file except in compliance with the License. You may obtain a copy of the License at <http://www.mozilla.org/MPL/>

Software distributed under the License is distributed on an "AS IS" basis, WITHOUT WARRANTY OF ANY KIND, either express or implied. See the License for the specific language governing rights and limitations under the License.

❑ **tinymce 2002.4.3**

www.sourceforge.net/projects/tinymce

Original file by Yves Berquin.

This software is provided 'as-is', without any express or implied warranty. In no event will the authors be held liable for any damages arising from the use of this software.

Permission is granted to anyone to use this software for any purpose, including commercial applications, and to alter it and redistribute it freely, subject to the following restrictions:

1. The origin of this software must not be misrepresented; you must not claim that you wrote the original software. If you use this software in a product, an acknowledgment in the product documentation would be appreciated but is not required.
2. Altered source versions must be plainly marked as such, and must not be misrepresented as being the original software.
3. This notice may not be removed or altered from any source distribution.



❑ Tremor

<http://wiki.xiph.org/index.php/Tremor>

Copyright (c) 2002, Xiph.org Foundation

Redistribution and use in source and binary forms, with or without modification, are permitted provided that the following conditions are met:

1. Redistributions of source code must retain the above copyright notice, this list of conditions and the following disclaimer.
2. Redistributions in binary form must reproduce the above copyright notice, this list of conditions and the following disclaimer in the documentation and/or other materials provided with the distribution.
3. Neither the name of the Xiph.org Foundation nor the names of its contributors may be used to endorse or promote products derived from this software without specific prior written permission.

THIS SOFTWARE IS PROVIDED BY THE COPYRIGHT HOLDERS AND CONTRIBUTORS "AS IS" AND ANY EXPRESS OR IMPLIED WARRANTIES, INCLUDING, BUT NOT LIMITED TO, THE IMPLIED WARRANTIES OF MERCHANTABILITY AND FITNESS FOR A PARTICULAR PURPOSE ARE DISCLAIMED. IN NO EVENT SHALL THE FOUNDATION OR CONTRIBUTORS BE LIABLE FOR ANY DIRECT, INDIRECT, INCIDENTAL, SPECIAL, EXEMPLARY, OR CONSEQUENTIAL DAMAGES (INCLUDING, BUT NOT LIMITED TO, PROCUREMENT OF SUBSTITUTE GOODS OR SERVICES; LOSS OF USE, DATA, OR PROFITS; OR BUSINESS INTERRUPTION) HOWEVER CAUSED AND ON ANY THEORY OF LIABILITY, WHETHER IN CONTRACT, STRICT LIABILITY, OR TORT (INCLUDING NEGLIGENCE OR OTHERWISE) ARISING IN ANY WAY OUT OF THE USE OF THIS SOFTWARE, EVEN IF ADVISED OF THE POSSIBILITY OF SUCH DAMAGE.

❑ zlib

<http://www.zlib.net/>

zlib.h -- interface of the 'zlib' general purpose compression library version 1.2.3, July 18th, 2005

Copyright (C) 1995-2004 Jean-loup Gailly and Mark Adler

This software is provided 'as-is', without any express or implied warranty. In no event will the authors be held liable for any damages arising from the use of this software.

Permission is granted to anyone to use this software for any purpose, including commercial applications, and to alter it and redistribute it freely, subject to the following restrictions:

1. The origin of this software must not be misrepresented; you must not claim that you wrote the original software. If you use this software in a product, an acknowledgment in the product documentation would be appreciated but is not required.
2. Altered source versions must be plainly marked as such, and must not be misrepresented as being the original software.
3. This notice may not be removed or altered from any source distribution.

Jean-loup Gailly jloup@gzip.org, Mark Adler
madler@alumni.caltech.edu



- ❑ **The Spotify software is subject to third party licenses found here:**

www.spotify.com/connect/third-party-licenses



DENON[®]

www.denon.com

3520 10714 00AD

Copyright © 2019 D&M Holdings Inc. All Rights Reserved.