

2.1 Channel Home Theater Sound Bar

TS5010

Quick start guide



1



- EN** Make sure you read all the safety information before you use this product.
- HR** Pročitajte sve informacije o sigurnosti prije upotrebe ovog proizvoda.
- CS** Před použitím tohoto výrobku si přečtěte všechny bezpečnostní informace.
- DA** Læs alle sikkerhedsoplysninger, før du bruger produktet.
- NL** Zorg dat u alle veiligheidsinformatie leest voor u dit product gebruikt.
- ET** Enne selle seadme kasutamist lugege kindlasti kõiki ohutuseeskirju.
- FI** Varmista, että olet lukenut kaikki turvallisuutta koskevat tiedot ennen tämän tuotteen käyttöä.
- FR** Assurez-vous de lire toutes les consignes de sécurité avant d'utiliser ce produit.
- DE** Vergewissern Sie sich, dass Sie sämtliche Sicherheitshinweise gelesen haben, bevor Sie dieses Produkt verwenden.
- HU** A készülék használatba vétele előtt olvassa el az összes biztonsági előírást.
- IT** Assicurarsi di avere letto tutte le informazioni sulla sicurezza prima di utilizzare il prodotto.
- NO** Les all sikkerhetsinformasjonen før du tar i bruk dette produktet.
- PL** Przed użyciem produktu należy dokładnie przeczytać wszystkie wskazówki dotyczące bezpieczeństwa.
- PT** Antes de utilizar este produtos, certifique-se de ler todas as informações de segurança.
- RU** Внимательно ознакомьтесь со всей информацией по безопасности изделия перед использованием изделия.
- SK** Pred použitím tohto produktu si prečítajte všetky bezpečnostné informácie.
- ES** Asegúrese de leer toda la información de seguridad antes de utilizar este producto.
- SV** Se till att du läser all säkerhetsinformation innan du använder den här produkten.
- TR** Ürünü kullanmadan önce tüm güvenli talimatlarını okuyunuz.
- UK** Уважно ознайомтея із усією інформацією стосовно техніки безпеки перед використанням пристрою.

A1



A2



B

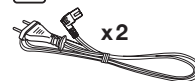

C



D



E



F



G



H



I



J



K



2



D

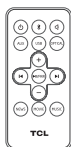

- EN** Activate/Replace the battery
HR Aktivirajte/zamijenite bateriju
CS Aktivace/výměna baterie
DA Aktivér/udskift batteriet
NL De batterij activeren/vervangen
ET Aktiveerige/asendage patarei
FI Aktivoi/vaihda akku
FR Activer/Remplacer la batterie
DE Aktivieren/Ersetzen der Batterie
HU Az akkumulátor aktiválása és cseréje
IT Attivare/Sostituire la batteria
NO Aktivere/Bytte ut batteriet
PL Aktywacja / wymiana baterii
PT Ativar/substituir a pilha
RU Активируйте/замените аккумуляторную батарею
SK Aktivácia/vymena batérie
ES Activar/Sustituir la batería
SV Aktivera/byt ut batteriet
TR Bataryayı etkinleştirin/ deęiřtirin.
UK Активация/Заміна батарейок

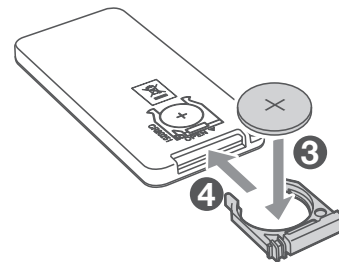
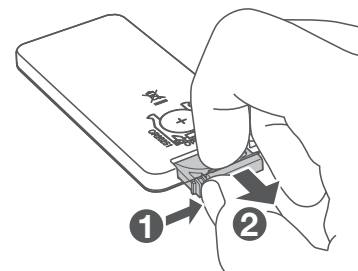
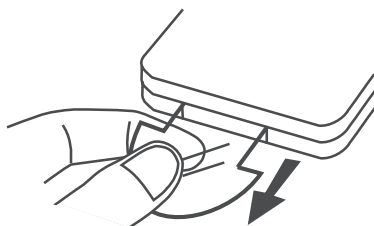

3a



- EN** Cables are sold separately.
- HR** Kabeli se prodaju zasebno.
- CS** Kabely se prodávají samostatně.
- DA** Kabler sælges særskilt.
- NL** Kabels worden afzonderlijk verkocht.
- ET** Kaablid tuleb eraldi osta.
- FI** Kaapelit myydään erikseen.
- FR** Les câbles sont vendus séparément.
- DE** Kabel sind separat erhältlich.
- HU** A kábeleket külön kell megvásárolni.
- IT** I cavi sono venduti separatamente.
- NO** Kabler selges separat.
- PL** Przewody sprzedawane są oddzielnie.
- PT** Os cabos são vendidos em separado.
- RU** Кабели продаются отдельно.
- SK** Káble sa predávajú samostatne.
- ES** Los cables se venden por separado.
- SV** Kablar säljs separat.
- TR** Kablolar ayrı olarak satılmaktadır.
- UK** Кабелі продаються окремо.

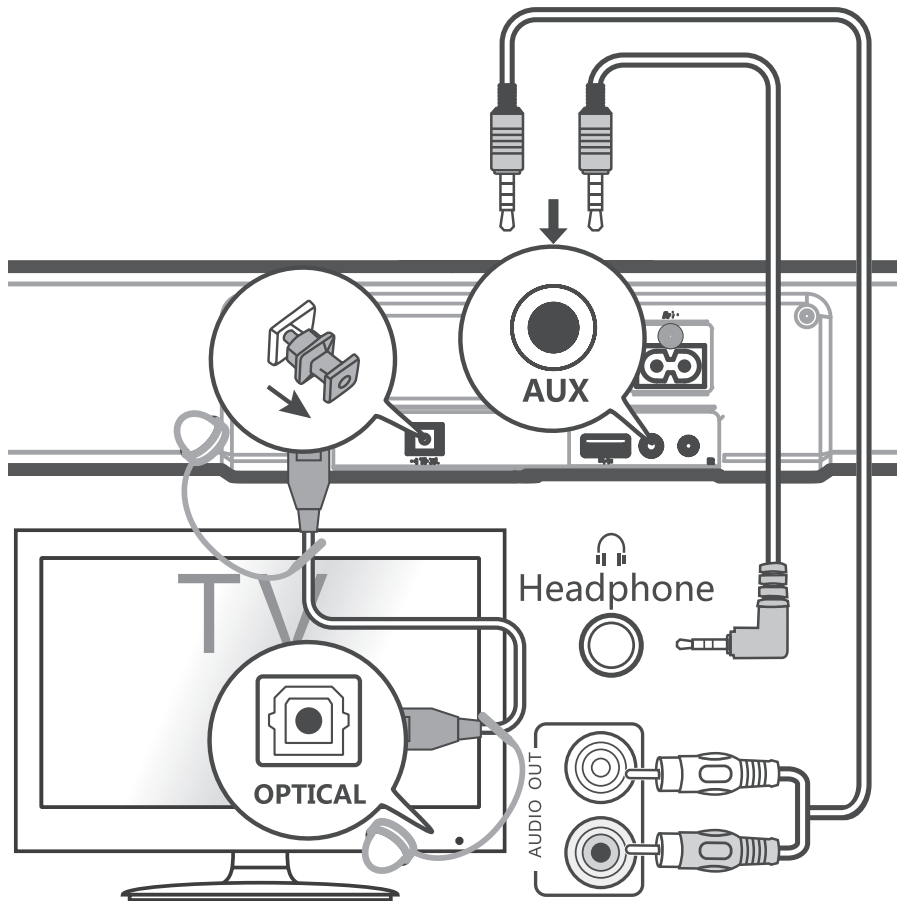

3b



TS5010

- EN** Standby power consumption
- HR** Potrošnja energije u stanju mirovanja
- CS** Spotřeba energie v pohotovostním režimu
- DA** Strømförbrug i standbytilstand
- NL** Stand-by-stroomverbruik
- ET** Energiatarve ooterežiimis
- FI** Virrankulutus valmiustilassa
- FR** Consommation électrique en veille
- DE** Leistungsaufnahme im Standby-Modus
- HU** Teljesítményfelvétel készenléti állapotban
- IT** Consumo di energia in stand-by
- NO** Strømförbruk i standby-modus
- PL** Pobór prądu w trybie czuwania:
- PT** Modo de suspensão de consumo de energia
- RU** Расход энергии в режиме энергии
- SK** Spotřeba energie v pohotovostnom režime
- ES** Consumo energético en espera
- SV** Strømförbrukning i viloläge
- TR** Bekleme konumu güç tüketimi
- UK** Споживання енергії в режимі очікування < 0.5W

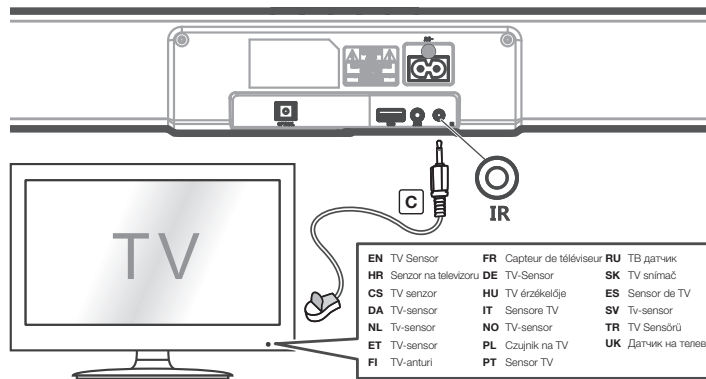
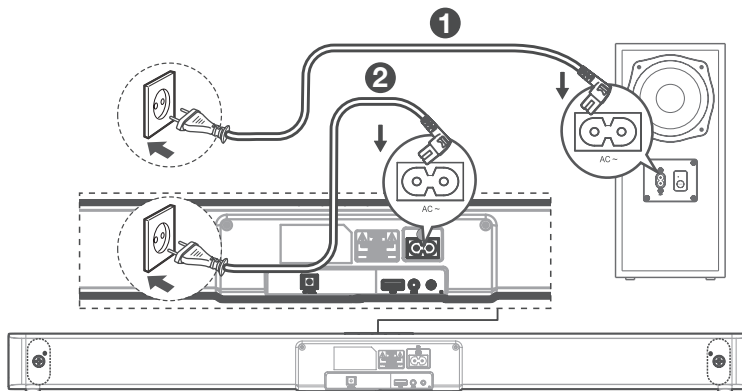

EN TV Sensor	FR Capteur de téléviseur	RU ТВ датчик
HR Senzor na televizoru	DE TV-Sensor	SK TV snímač
CS TV senzor	HU TV érzékelője	ES Sensor de TV
DA TV-sensor	IT Sensore TV	SV Tv-sensor
NL Tv-sensor	NO Tv-sensor	TR TV Sensörü
ET TV-sensor	PL Czujnik na TV	UK Датчик на телевізорі
FI TV-anturi	PT Sensor TV	

4a



A1



A2

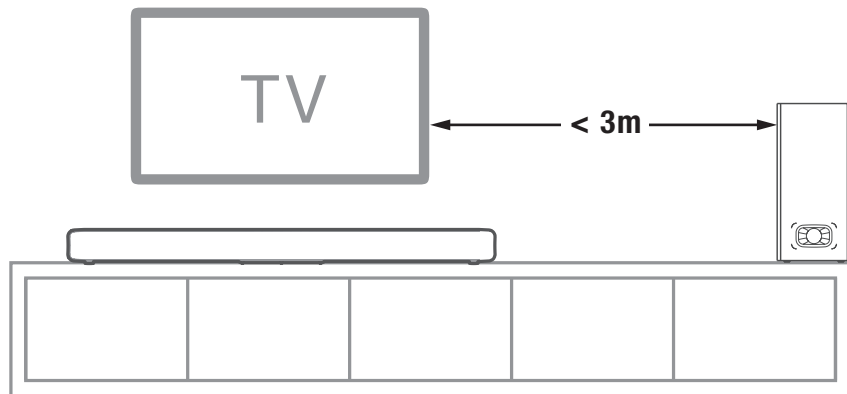

4b



A1



K

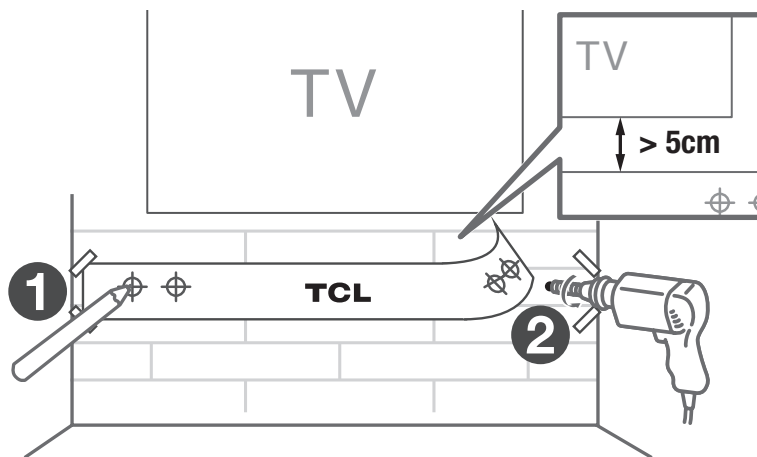
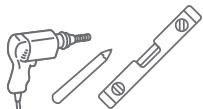

4b

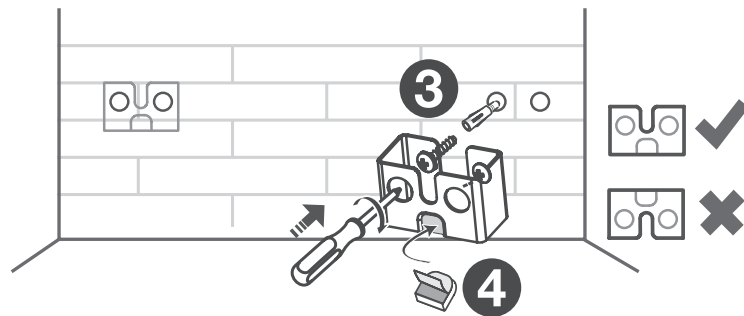

A1

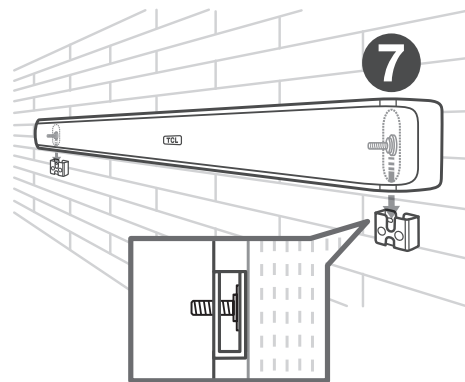
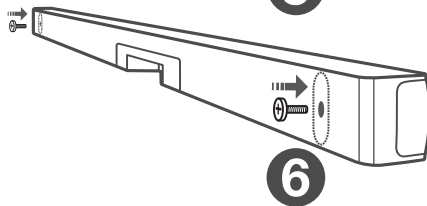
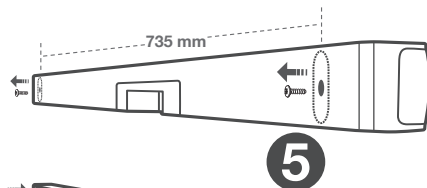

5



Bluetooth

- EN** Frequency range/Max transmitting power
- HR** Frekvencijski raspon/najveća snaga odašiljanja
- CS** Frekvenční rozsah / maximální vysílací výkon
- DA** Frekvensområde/maks. sendeeffekt
- NL** Frequentiebereik/Max. uitgangsvermogen
- ET** Sagedusriba / max saatmisvõimsus
- FI** Taajuusalue/enimmäislähetysteho
- FR** Gamme de fréquence / Puissance d'émission maximale
- DE** Frequenzbereich/Maximale Sendeleistung
- HU** Frekvencia/max. adási teljesítmény
- IT** Gamma di frequenza/Massima potenza di trasmissione
- NO** Frekvensverdi/Maks. sendeytelse
- PL** Zakres częstotliwości / maks. moc nadajnika
- PT** Gama de frequências/potência máx. de transmissão
- RU** Диапазон частот/макс. мощность передачи
- SK** Frekvenčný rozsah/max. vysielací výkon
- ES** Rango de frecuencia/Potencia máxima de transmisión
- SV** Frekvensintervall/maxöverföring
- TR** Frekans aralığı/Maks. verici gücü
- UK** Діапазон частот/Макс. потужність передачі

2402–2480 Mhz/5dBm

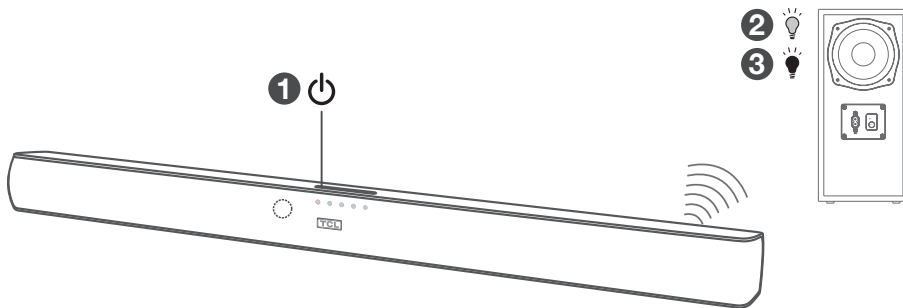
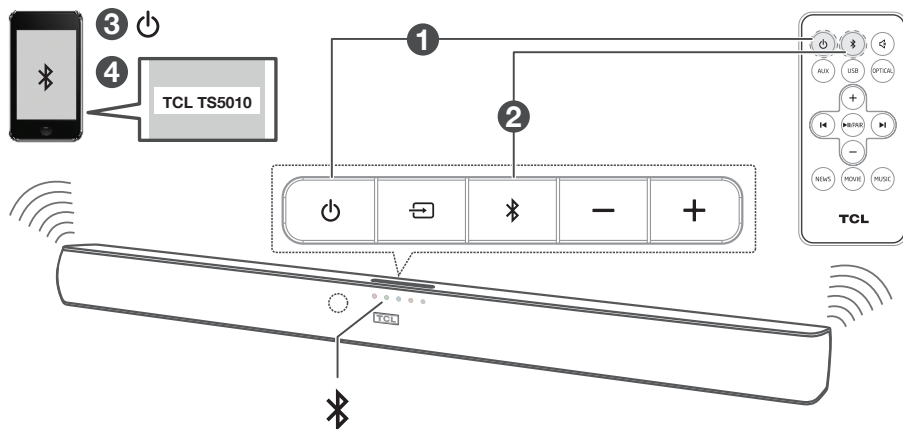

6

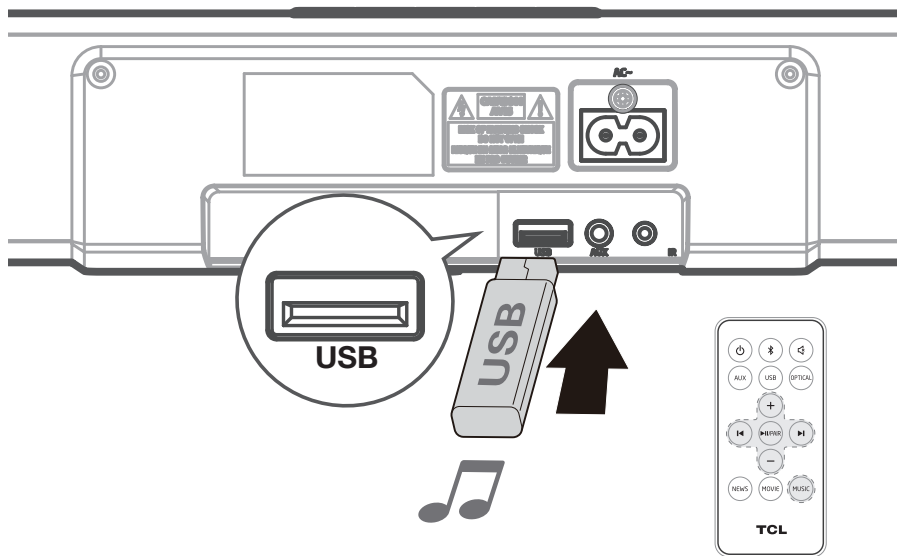

7a

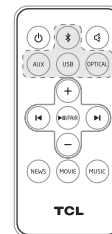
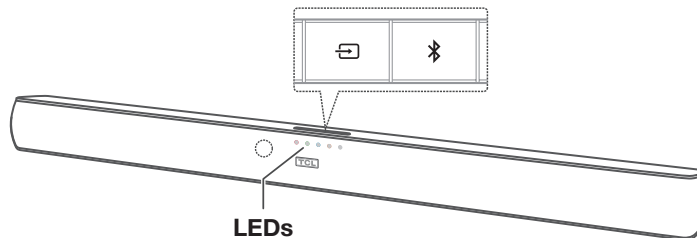

EN	HR	CS	DA	NL	ET	FI	FR	DE	HU										
<i>Source/ Status</i>	<i>LED</i>	<i>Izvor/ status</i>	<i>LED</i>	<i>Zdroj/ stav</i>	<i>LED</i>	<i>Kilde/ status</i>	<i>Lysdiode</i>	<i>Bron/ Status</i>	<i>Led</i>	<i>Allikas/ olek</i>	<i>LED</i>	<i>Lähde/ tila</i>	<i>LED</i>	<i>Source/ Etat</i>	<i>LED</i>	<i>Quelle/ Status</i>	<i>LED</i>	<i>Jelforras/ állapot</i>	<i>LED</i>
Standby	Red	Stanje mirovanja	Crveno	Pohotovostní režim	Červená	Standby	Red	Stand-by	Rood	Ooterežim	Punane	Valmiustila	Punainen	Veille	Rouge	Standby	Rot	Készletét	Piros
AUX	Green	AUX	Zeleno	AUX	Zelená	AUX	Grön	AUX	Gröen	AUX-sisend	Roheline	AUX	Vihreä	AUX	Vert	AUX	Grün	AUX	Zöld
Bluetooth	Blue	Bluetooth	Plavo	Bluetooth	Modrá	Bluetooth	Blá	Bluetooth	Blauw	Bluetooth-režim	Sinine	Bluetooth	Sininen	Bluetooth	Bleu	Bluetooth	Blau	Bluetooth	Kék
Optical	Orange	Optički	Narančasto	Optický	Oranžová	Optisk	Orange	Optisch	Oranje	Optiline sisend	Oranž	Optinen	Oranssi	Optique	Orange	Optisch	Orange	Optikai	Narancs
USB	White	USB	Bijelo	USB	Bílá	USB	Hvid	USB	Wit	USB-sisend	Valge	USB	Valkoinen	USB	Blanc	USB	Weiß	USB	Fehér
	Blue	Plavo	Modrá	Blá	Blauw	Sinine	Sininen	Bleu	Blau	Kék									
Ready to pair	Flashes slowly	Spretno za uparivanje	Polako bijeska	Připraveno k párování	Bliká pomalu	Klar til pairing	Blinker langsomt	Gereed om te koppelen	Knippert langzaam	Valmis sidumiseks	Vilgub aeglaselt	Valmis parilifokseen	Vilkkuu hitaasti	Prêt à apparier	Clignote lentement	Bereit zum Koppeln	Blinkt langsam	Párosításra kész	Lassan villog
Pairing in progress	Flashes quickly	Uparivanje u tijeku	Brzo bijeska	Probhá párování	Bliká rychle	Pairing i gang	Blinker hurtigt	Koppelen in uitvoering	Knippert snel	Sidumine poleli	Vilgub kiiresti	Parilifot käynnissä	Vilkkuu nopeasti	Apparaige en cours	Clignote rapidement	Kopplung läuft	Blinkt schnell	Párosítás folyamatban	Gyorsan villog
IT	NO	PL	PT	RU	SK	ES	SV	TR	UK										
<i>Sorgente/ Stato</i>	<i>LED</i>	<i>Kilde/ Status</i>	<i>LED</i>	<i>Žródło/ stan</i>	<i>LED</i>	<i>Fonte/ estado</i>	<i>LED</i>	<i>Источники/ Состояние</i>	<i>LED</i>	<i>Zdroj/ stav</i>	<i>LED</i>	<i>Fuente/ Estado</i>	<i>LED</i>	<i>Källa/ Status</i>	<i>LED</i>	<i>Kaynak/ Durum</i>	<i>LED</i>	<i>Джерело/ Стан</i>	<i>Світлодіод</i>
Stand-by	Rosso	Standby	Red	Tyń czuwania	Czerwony	Modo se suspensão	Vermelho	Режим ожидания	Красный	Pohotovostný režim	Červená	Espere	Rojo	Viloläge	Röd	Bekleme konumu	Kırmızı	Режим очікування	Червоний
AUX	Verde	AUX	Grön	AUX	Zielony	AUX	Verde	AUX	Зеленый	POMOCNÝ	Zelená	AUX	Verde	AUX	Grön	AUX	Yeşil	AUX	Зелений
Bluetooth	Blu	Bluetooth	Blá	Bluetooth	Niebieski	Bluetooth	Azul	Bluetooth	Синий	Bluetooth	Modrá	Bluetooth	Azul	Bluetooth	Blá	Bluetooth	Mavi	Bluetooth	Синий
Optico	Arancione	Optisk	Oransje	Moduły optyczne	Pomarańczowy	Óptico	Laranja	Оптический	Оранжевый	Optický	Oranžová	Óptico	Naranja	Optisk	Orange	Optik	Turuncu	Оптический вход	Помаранчевий
USB	Bianco	USB	Hvit	USB	Biały	USB	Branco	USB	Белый	USB	Bjela	USB	Bianco	USB	Vit	USB	Beşaz	USB	Білий
	Blu	Blá	Niebieski	Azul	Sinий	Modrá	Azul	Blá	Sinий										
Pronto per abbinamento	Lampeggia lentamente	Klar for pairing	Blinker sakte	Gotowy do parowania	Miga wolno	Pronto para emparejar	Pisca lentamente	Готов к сопряжению	Медленно мигает	Připravené na párovanie	Pomalé blikanie	Listo para vincular	Parpadea lentamente	Redo att parkoppla	Blinkar långsamt	Eşleştime için hazır	Yavaş yavaş yanıp söner	Готовність до подання	Блимає повільно
Abbinamento in corso	Lampeggia velocemente	Pairing på gang	Blinker raskt	Twa parowanie	Miga szybko	Emparejamiento en curso	Pisca rápidamente	Выполняется сопряжение	Быстро мигает	Párovanie prebieha	Rychle blikanie	Vinculación en progreso	Parpadea rápidamente	Parkoppling pågår	Blinkar snabbt	Eşleştime sürüyor	Hızlı yanıp söner	Виконується подання	Блимає швидко

7b

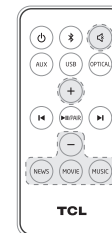
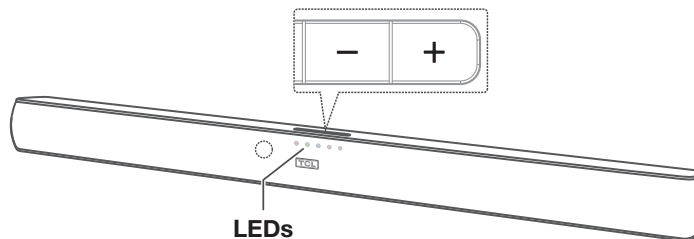

EN	HR	CS	DA	NL	ET	FI	FR	DE	HU
LED	LED	LED	Lysdiode	Led	LED	LED	LED	LED	LED
+/- White - flashes quickly, then back to the source LED	Bijelo - brzo bljeska, a zatim se vrati na izvorno stanje LED žaruljice	Bílá - rychle zabliká, poté se vrátí na zdrojovou LED	Hvid - blinker hurtigt. Vender derefter tilbage til lysdiode for kilde	Wit - knippert snel en gaat dan terug naar de bron-led	Valge - vilgub kiiresti, seejärel naaseb allika LED-režimisi	Valkoinen - vilkkuu nopeasti, palaa sitten lähteen LED-valoon	Blanc - clignote rapidement, puis revient à la LED de la source	Weiß - blinkt schnell und kehrt dann zur LED der zugehörigen Quelle zurück	Fehér - gyorsan villog, majd visszatér a jelforrás jelezésére
🔊 Red - flashes	Crveno - bljeska	Červená - zabliká	Red - blinker	Rood - knippert	Punane - vilgub	Punainen - vilkkuu	Rouge - clignote	Rot - blinkt	Piros - villog
MOVIE White - flashes x 1	Bijelo - jedan bljesak	Bílá - zabliká 1krát	Hvid - blinker x 1	Wit - knippert x 1	Valge - vilgub 1 kord	Valkoinen - vilkkuu x 1	Blanc - clignote 1 fois	Weiß - blinkt x 1	Fehér - 1 x felvilan
MUSIC Green - flashes x 1	Zeleno - jedan bljesak	Zelená - zabliká 1krát	Gron - blinker x 1	Groen - knippert x 1	Roheline - vilgub 1 kord	Vihreä - vilkkuu x 1	Vert - clignote 1 fois	Grün - blinkt x 1	Zöld - 1 x felvilan
NEWS Orange - flashes x 1	Narančasto - jedan bljesak	Oranžová - zabliká 1krát	Orange - blinker x 1	Oranje - knippert x 1	Oranž - vilgub 1 kord	Oranssi - vilkkuu x 1	Orange - clignote 1 fois	Orange - blinkt x 1	Narancs - 1 x felvilan

IT	NO	PL	PT	RU	SK	ES	SV	TR	UK
LED	LED	LED	LED	LED	LED	LED	LED	LED	Світлодіод
+/- Bianco - lampeggia velocemente, poi torna al LED sorgente	Hvít - blinker raskt, og går tilbake til kilden LED	Biały - miga szybko, a następnie włącza się dioda źródła	Branco - pisca rapidamente e, em seguida, regressa ao LED fonte	Белый, быстро мигает, а затем возвращается к исходному состоянию LED	Bielá - rýchle blikanie, potom späť na zdrojové LED	Bianco: parpadea rápidamente y vuelve al led fuente	Vit - blinkar snabbt, sedan tillbaka till käll-LED	Beşaz - hızlı yanıp söner, daha sonra kaynağa LED'e geri döner	Білий - блимає швидко, потім повертається в режим світлодіода джерела
🔊 Rosso - lampeggia	Red - blinker	Czerwony - miga	Vermelho - pisca	Красный, мигает	Červená - blikanie	Rojo: parpadea	Röd - blinkar	Kırmızı - yanıp söner	Червоный - блимає
MOVIE Bianco - lampeggia 1 volta	Hvít - blinker x 1	Biały - miga x 1	Branco - pisca x 1	Белый, мигает 1 раз	Bielá - 1 bliknutie	Bianco: parpadea 1 vez	Vit - blinkar x 1	Beşaz - yanıp söner x 1	Білий - блимає x 1
MUSIC Verde - lampeggia 1 volta	Gronn - blinker x 1	Zielony - miga x 1	Verde - pisca x 1	Зеленый, мигает 1 раз	Zelená - 1 bliknutie	Verde: parpadea 1 vez	Grön - blinkar x 1	Yeşil - yanıp söner x 1	Зелений - блимає x 1
NEWS Arancione - lampeggia 1 volta	Oranje - blinker x 1	Pomarańczowy - miga x 1	Laranja - pisca x 1	Оранжевый, мигает 1 раз	Oranžová - 1 bliknutie	Naranja: parpadea 1 vez	Orange - blinkar x 1	Turuncu - yanıp söner x 1	Помаранчевий - блимає x 1

**WE ARE
READY TO
HELP** contact us first
with any questions



TCL SUPPORT:
www.tcl.com/support



**TAKE CARE WHEN
REMOVING THE SOUNDBAR**

2019 © TCL Entertainment Solutions Limited. All rights reserved.
This product has been manufactured by and is sold under the
responsibility of TCL Entertainment Solutions Limited.

TS5010_EU_QSG_V1.0

