

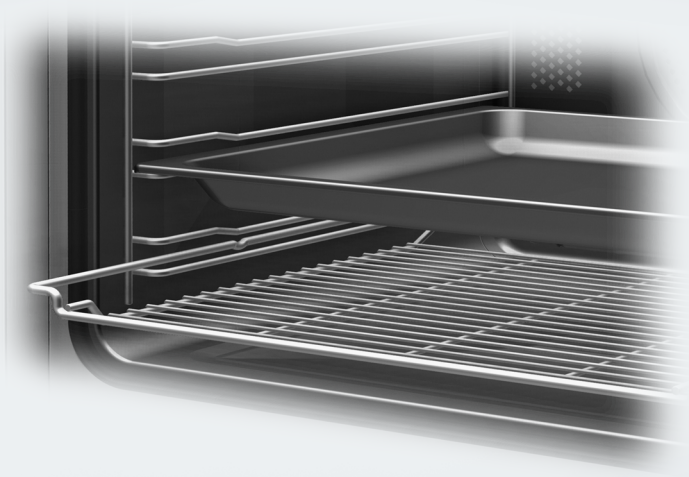

Operating and installation instructions



Oven





To prevent the risk of accidents or damage to the appliance, it is **essential** to read these instructions before it is installed and used for the first time.



Contents

Warning and Safety instructions	7
Caring for the environment	19
Oven overview	20
Controls	21
On/Off sensor ①	22
Sensors controls	22
Touch display	23
Main menu.....	24
Symbols.....	24
Operating principles	25
Features	27
Model numbers	27
Data plate	27
Items supplied with delivery	27
Standard and optional accessories.....	27
Shelf runners	28
Baking tray, universal tray and rack with non-tip safety notches.....	28
FlexiClip telescopic runners HFC 72	29
Oven controls	33
Oven safety features	33
System lock 	33
Sensor lock for the oven	33
Safety switch-off	33
Cooling fan	33
Vented oven door	33
Door lock for Pyrolytic cleaning	34
PerfectClean treated surfaces	34
Pyrolytic accessories.....	34
Using for the first time	35
General settings	35
Heating up the oven for the first time and rinsing the steam injection system	37
Settings	39
Calling up the "Settings" menu	39
Changing and saving settings.....	39
Settings overview	40
Language 	41
Time of day.....	41
Display.....	41



Clock display	41
Clock format	41
Setting	41
Synchronise	41
Date	42
Lighting	42
Start screen	42
Brightness	42
Volume	43
Buzzer tones	43
Keypad tone	43
Welcome melody	43
Units	43
Weight	43
Temperature	43
Cooling fan run-on	44
Recommended temperatures	44
Pyrolytic cleaning	44
Safety	45
System lock 	45
Sensor lock	45
Catalyser	46
Showroom programme	46
Demo mode	46
Factory default settings	46
MyMiele	47
Adding an entry	47
Editing MyMiele	48
Deleting entries	48
Sorting entries	48
Minute minder + Alarm	49
Using the alarm 	49
Setting the alarm	49
Changing an alarm	49
Deleting an alarm	49
Using the minute minder 	50
Setting the minute minder	50
Changing the time set for the minute minder	51
Cancelling the time set for the minute minder	51
Overview of functions	52

Contents

Tips on saving energy	54
Operation	56
Basic operation	56
Cooling fan	56
Using the oven - further functions	57
Changing the temperature.....	58
Rapid Heat-up	58
Rapid Heat-up	59
Pre-heating the oven	59
Using the Crisp function (moisture reduction).....	60
Changing the oven function	60
Setting durations	61
Switching off automatically	61
Switching on and off automatically	62
Sequence of a programme that switches on and off automatically	62
Changing an entered cooking time	63
Cancelling cooking	63
Moisture Plus 	64
Cooking with the Moisture Plus  function.....	65
Setting the temperature.....	65
Setting the number of bursts of steam.....	65
When to add the bursts of steam.....	66
Preparing and starting the water intake process.....	66
Changing the type of heating	67
Injecting bursts of steam	68
Automatic burst of steam	68
1, 2 or 3 bursts of steam	68
Evaporating residual moisture.....	69
Starting residual moisture evaporation immediately	70
Skipping residual moisture evaporation	70
Automatic programmes	71
List of food types.....	71
Using Automatic programmes.....	71
Notes on use	72
Search	73
User programmes	74
Creating a User programme	74
Starting a User programme.....	75

Changing User programmes	76
Changing cooking stages.....	76
Changing a name	76
Deleting User programmes	77
Baking	78
Notes on using the baking charts	79
Baking charts	80
Creamed mixture.....	80
Rubbed in mixture.....	82
Yeast mixtures and quark dough.....	84
Whisked mixture.....	86
Choux pastry, puff pastry, meringue.....	87
Roasting	88
Notes on using the roasting charts	89
Roasting charts	90
Beef, veal.....	90
Pork	91
Lamb, game	92
Poultry, fish.....	93
Food probe	94
How it works.....	94
When the food probe can be used.....	95
Important notes about using the food probe	95
Using the food probe	97
Time remaining display	98
Using residual heat.....	98
Low temperature cooking	99
Using the "Low temperature cooking" special application	100
Low temperature cooking - setting the temperature manually.....	101
Grilling	102
Notes on the grilling chart	104
Fan Grill 	105
Grill 	107
Special applications	108
Defrost.....	109
Drying	110
Reheat	111
Heat crockery	111
Prove yeast dough	112

Contents

Pizza	112
Gentle Bake	113
Bottling	114
Frozen food/Ready meals.....	115
Cleaning and care	116
Unsuitable cleaning agents	116
Useful tips	117
Normal soiling.....	117
Food probe	117
Stubborn soiling (excluding the FlexiClip telescopic runners).....	118
Pyrolytic cleaning  of the oven interior	119
Setting up for the Pyrolytic cleaning programme.....	119
Starting the Pyrolytic cleaning programme	120
Starting the Pyrolytic cleaning programme	120
Delaying the start time of the Pyrolytic cleaning programme	120
At the end of the Pyrolytic cleaning programme	121
The Pyrolytic cleaning programme is cancelled.....	122
Removing the door.....	123
Dismantling the door	124
Fitting the door	128
Removing the shelf runners with FlexiClip telescopic runners.....	129
Lowering the top heat/grill element.....	130
Descaling the steam injection system 	131
Descaling process sequence	131
Preparing the descaling process.....	132
Starting the descaling process.....	132
Problem solving guide	136
After sales service and warranty	142
Electrical connection	143
Building-in diagrams	144
Appliance dimensions and unit cut-out	144
Installation in a base unit.....	144
Installation in a tall unit.....	145
Front dimensions	146
Installing the oven	147
Copyright and licences	148

Warning and Safety instructions

This appliance conforms to current safety requirements. Inappropriate use can, however, lead to personal injury and damage to property.

To avoid the risk of accidents and damage to the appliance, please read these instructions carefully before using it for the first time. They contain important notes on installation, safety, use and maintenance. Miele cannot be held liable for non-compliance with these instructions. Keep these instructions in a safe place and ensure that new users are familiar with the contents. Pass them on to any future owner.

Warning and Safety instructions

Correct application

▶ This oven is designed for domestic use and for use in similar environments by guests in hotel or motel rooms, bed & breakfasts and other typical living quarters. This does not include common/shared facilities or commercial facilities within hotels, motels or bed & breakfasts.

▶ The oven is not suitable for outdoor use.

▶ The oven is intended only to cook, bake, roast, grill, defrost, bottle, dry fruit etc.

Any other usage is at the owner's risk.

▶ This oven is not intended for use by persons (including children) with reduced physical, sensory or mental capabilities, or lack of experience and knowledge, unless they are supervised whilst using it or have been given instruction concerning its use by a person responsible for their safety.

They must be able to recognise the dangers of misuse.

▶ This oven is supplied with a special lamp to cope with particular conditions (e.g. temperature, moisture, chemical resistance, abrasion resistance and vibration). This special lamp must only be used for the purpose for which it is intended. It is not suitable for room lighting.

Safety with children

- ▶ Young children must not be allowed to use this appliance.
- ▶ Older children may only use the appliance when its operation has been clearly explained to them and they are able to use it safely, recognising the dangers of misuse.
- ▶ Cleaning work may only be carried out by older children under the supervision of an adult.
- ▶ Children should be supervised near the appliance. Ensure that they do not play with the appliance.
- ▶ Danger of suffocation! Children may be able to wrap themselves in packing material or pull it over their heads with the risk of suffocation. Keep children away from any packing material.

Warning and Safety instructions

▶ Danger of burning! Children's skin is far more sensitive to high temperatures than that of adults. Great care should be taken to ensure that children do not touch the appliance when it is being used. External parts of the oven such as the door glass, control panel and the vents become quite hot.

▶ Danger of burning!

Children's skin is far more sensitive to high temperatures than that of adults. The oven becomes hotter during the Pyrolytic cleaning programme than it does in normal use. Do not let children touch the oven while the Pyrolytic cleaning programme is running.

▶ Danger of injury! The maximum load capacity for the door is 15 kg. Children can hurt themselves on an open door. Ensure that children do not sit on or swing on the door.

▶ When the  sensor is touched the door opens all the way automatically. Make sure that no one is in its direction of travel as it could hit young children or pets, for example, if they are in the way.

Technical safety

- ▶ Repairs and other work by unqualified persons could be dangerous. Installation, maintenance work and repairs to electrical appliances must only be carried out by a Miele approved service technician.
- ▶ A damaged appliance is dangerous. Check it for any visible damage. Never install or attempt to use a damaged appliance.
- ▶ Reliable and safe operation of this oven can only be assured if it has been connected to the mains electricity supply.
- ▶ The electrical safety of this appliance can only be guaranteed when continuity is complete between it and an effective earthing system. It is most important that this basic safety requirement is present and tested regularly and, where there is any doubt, the household wiring system should be inspected by a qualified electrician.
- ▶ Before connecting the appliance to the mains supply, make sure that the rating on the data plate (voltage and frequency) corresponds to that of the household supply.
This data must correspond in order to avoid risk of damage to the appliance. Consult a qualified electrician if in any doubt.
- ▶ Do not connect the appliance to the mains electricity supply by a multi-socket unit or an extension lead. These do not guarantee the required safety of the appliance (e.g. danger of overheating).
- ▶ For safety reasons, this appliance may only be used when it has been built in.

Warning and Safety instructions

- ▶ This oven must not be installed and operated in mobile installations (e.g. on a ship).
- ▶ Tampering with electrical connections or components and mechanical parts is highly dangerous to the user and can cause operational faults.
Do not open the outer casing of the appliance.
- ▶ The manufacturer's warranty will be invalidated if the appliance is not repaired by a Miele approved service technician.
- ▶ Faulty components must only be replaced by genuine Miele spare parts. The manufacturer can only guarantee the safety of the appliance when Miele replacement parts are used.
- ▶ If the oven is delivered without a mains connection cable, or if the mains connection cable is damaged, it must only be replaced by a Miele approved service technician (see "Electrical connection") in order to avoid a hazard.
- ▶ During installation, maintenance and repair work, the appliance must be disconnected from the mains electricity supply, e.g. if the oven lighting is faulty (see "Problem solving guide"). It is only completely isolated from the electricity supply when:
 - it is switched off at the mains circuit breaker, or
 - it is switched off at the wall socket and the plug is withdrawn from the socket. Do not pull the mains connection cable but the mains plug to disconnect your appliance from the mains electricity supply.

Warning and Safety instructions

- ▶ For the oven to function correctly, it requires a sufficient intake of cool air. Ensure the intake of cool air to the oven is not impaired (e.g. due to the installation of insulation material inside the housing unit). Furthermore, the incoming cool air must not be excessively heated by other heat sources (e.g. fuel furnaces).
- ▶ If the oven is installed behind a furniture door, do not close the door while the oven is in operation. Heat and moisture would build up behind a closed furniture door, potentially causing damage to the oven, the furniture unit and the flooring. Wait until the oven has cooled down completely before closing the furniture door.

Warning and Safety instructions

Correct use

Danger of burning!

The oven becomes hot when in use.

Exercise care when handling food and trays so as not to burn yourself on heating elements, the walls of the oven, shelf runners, trays and hot food itself.

Use oven gloves when placing food in the oven, turning or removing it and when adjusting oven shelves etc. in a hot oven.

- ▶ Do not use the oven to heat up the room.

Due to the high temperatures radiated, objects left near the appliance could catch fire.

- ▶ Never leave the appliance unattended when cooking with oil or fat. They can ignite if overheated.

Do not use water on grease fires. Turn off the oven immediately and suffocate the flames by keeping the oven door closed.

- ▶ Make sure that you keep to the recommended grilling times when using grilling functions.

Excessively long grilling times can lead to food drying out and burning or could even cause the food to catch fire.

- ▶ Some foods dry out very quickly and can be ignited by high grilling temperatures.

Do not use grilling functions for crisping rolls or bread or to dry flowers or herbs. Instead use Fan Plus  or Conventional Heat .

- ▶ If using alcohol in your recipes, please be aware that high temperatures can cause the alcohol to vaporise and even to ignite on the hot heating elements.

- ▶ When residual heat is used to keep food warm, the high level of humidity and condensation can cause corrosion in the oven. The control panel, worktop or furniture unit may also be damaged. Do not switch the oven off completely while food is inside it, but select the lowest possible temperature for the oven function you are using. This will ensure the fan will automatically continue to run.



Warning and Safety instructions

▶ Food which is stored in the oven or left in it to be kept warm can dry out and the moisture released can lead to corrosion damage in the oven.

Always cover food that is left in the oven to keep warm.

▶ A build-up of heat can cause the enamel on the floor of the oven to crack or shatter.

Do not line the floor of the oven with anything, e.g. aluminium foil.

If you wish to place dishes on the floor of the oven during cooking, or place crockery on the floor of the oven to heat it up, you can do so, but only with the Fan Plus  or Gentle Bake  function.

Rapid Heat-up must be switched off.

▶ The enamelling on the oven floor can become damaged by items being pushed around on it.

If using the oven to store pots and pans, ensure that you avoid pushing them around on the oven floor.

▶ Never pour cold water onto hot surfaces in a hot oven.

The steam created could cause serious burns or scalding and the sudden change in temperature can damage the enamel in the oven.

▶ During cooking processes using moisture and during the residual moisture evaporation process steam is produced which can cause serious injury by scalding. Do not open the door whilst a burst of steam is being released or during the evaporation process.

▶ It is important that the heat is allowed to spread evenly throughout the food being cooked.

This can be achieved by stirring or turning the food.

▶ Plastic containers, which are not heat-resistant, melt and may ignite at high temperatures and can damage the oven.

Use only plastic containers that are indicated by the manufacturer as being suitable for use in ovens.

Warning and Safety instructions

- ▶ Do not use the appliance to heat up or bottle food in sealed jars and tins. Pressure will build up inside them and they can explode causing damage to the appliance, as well as the risk of injury and scalding.
- ▶ Do not leave the oven door open unnecessarily as someone may trip over it or be injured by it.
- ▶ The oven door can support a maximum load of 15 kg. Do not lean or sit on an open oven door, or place heavy items on it. Also make sure that nothing can get trapped between the door and the oven cavity. This could damage the oven.

Cleaning and care

- ▶ Do not use a steam cleaning appliance to clean this oven. Pressurised steam could reach the electrical components and cause a short circuit.
- ▶ Scratches on the door glass can result in the glass breaking. Do not use abrasive cleaners, hard sponges, brushes or sharp metal tools to clean the door glass.
- ▶ The shelf runners can be removed for cleaning (see "Cleaning and care"). Ensure that they are replaced correctly and do not use the oven without them fitted.
- ▶ Coarse soiling should be removed before running the Pyrolytic cleaning programme. If not removed, coarse soiling can smoke and cause the Pyrolytic cleaning programme to switch itself off.
- ▶ In areas which may be subject to infestation by cockroaches or other vermin, pay particular attention to keeping the appliance and its surroundings clean at all times. Any damage caused by cockroaches or other vermin will not be covered by the warranty.

Warning and Safety instructions

Accessories

- ▶ Use only genuine original Miele spare parts. If spare parts or accessories from other manufacturers are used, the warranty will be invalidated, and Miele cannot accept liability.
- ▶ If you have a Miele HUB 5000-M/HUB 5001-M/HUB 5000-XL/HUB 5001-XL (if available) oven dish, do not place it on shelf level 1. This would damage the floor of the oven. The very small gap between the bottom of the dish and the oven floor would cause a build-up of heat and could cause the enamel to crack or chip. Do not place Miele oven dishes on the top rail of shelf level 1 as they will not be secured in this position by the anti-tip safety notches on the sides of the dishes. Instead, use shelf level 2 for these oven dishes.
- ▶ Only use the Miele food probe supplied with this oven. If it is faulty, it must only be replaced with a suitable original Miele food probe.
- ▶ The plastic on the food probe can melt at very high temperatures. Do not use the food probe when grilling (Exception: Fan Grill ). If you are not using the food probe, do not store it in the oven.
- ▶ The high temperatures used during the Pyrolytic cleaning programme will damage accessories that are not designed for cleaning in the Pyrolytic programme. Please remove these accessories from the oven interior before starting the Pyrolytic cleaning programme. This also applies to non-pyrolytic accessories purchased separately to the oven (see "Cleaning and care").

Disposal of the packing material

The transport and protective packaging has been selected from materials which are environmentally friendly for disposal, and can normally be recycled.

Recycling the packaging reduces the use of raw materials in the manufacturing process and also reduces the amount of waste in landfill sites. Ensure that any plastic wrappings, bags etc. are disposed of safely and kept out of the reach of babies and young children. Danger of suffocation.

Disposing of your old appliance

Electrical and electronic appliances often contain valuable materials. They also contain specific materials, compounds and components, which were essential for their correct function and safety. These could be hazardous to human health and to the environment if disposed of with your domestic waste or if handled incorrectly. Please do not, therefore, dispose of your old appliance with your household waste.





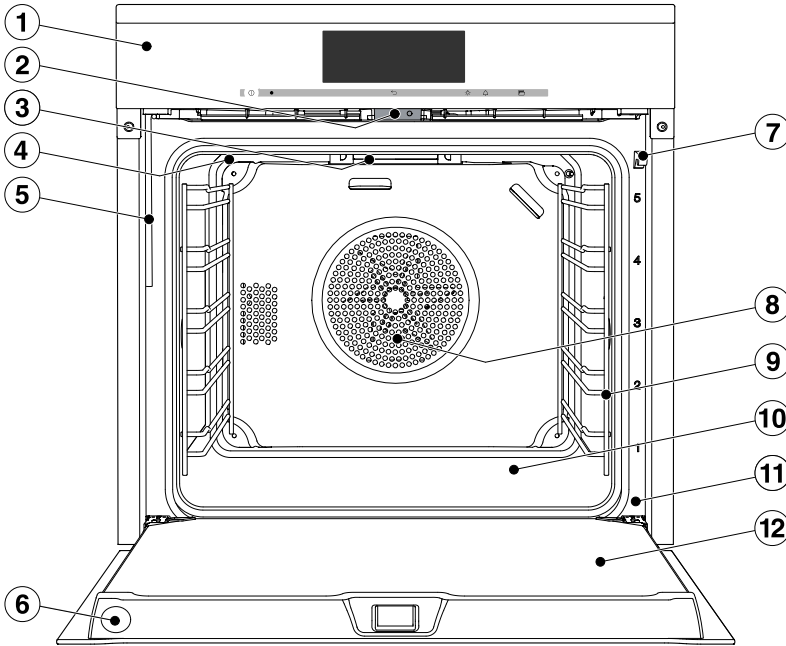

Please dispose of it at your local community waste collection / recycling centre for electrical and electronic appliances. You are also responsible for deleting any personal data that may be stored on the appliance prior to disposal. Please ensure that your old appliance poses no risk to children while being stored prior to disposal.

Oven overview

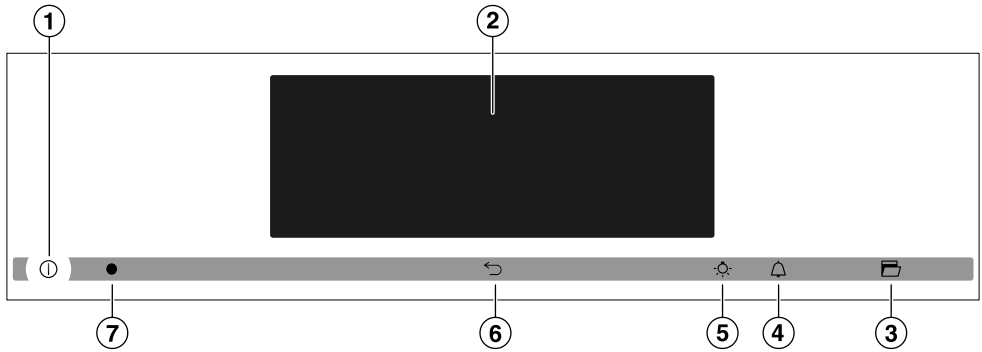

- ① Oven controls
- ② Door lock for Pyrolytic cleaning
- ③ Top heat / grill element with wireless food probe antenna
- ④ Steam inlet openings
- ⑤ Water intake pipe for the steam injection system
- ⑥ Wireless food probe holder
- ⑦ Door lock mechanism
- ⑧ Air inlet for the fan with ring heating element behind it
- ⑨ Shelf runners with 5 shelf levels
- ⑩ Oven floor with bottom heat element underneath it
- ⑪ Front frame with data plate
- ⑫ Door



- ① Recessed On/Off sensor ①
For switching the appliance on and off
- ② Display
Displays time of day and information for operation
- ③  sensor
For opening the door
- ④  sensor
For setting the minute minder
- ⑤  sensor
For switching the oven interior lighting on and off
- ⑥  sensor
To go back one step at a time
- ⑦ Optical interface
(for service technician use only)

Controls





On/Off sensor

The On/Off sensor  is recessed and reacts to touch.

It is used for switching the oven on and off.

Sensors controls

The sensors react to touch. Each touch is confirmed with a keypad tone. This keypad tone can be switched off (see "Settings – Volume – Keypad tone").

Sensor	Function	Notes
	For opening the door	The door opens automatically. To close it, press the door with your hand or, using a suitable pot holder or oven glove, press against the frame until the door is shut. If the display is dark, this sensor will not react until the oven is switched on.
	For activating and deactivating minute minder / alarm	If a list of options is visible in the display or if a cooking process is running, you can enter a minute minder duration (e.g. when boiling eggs on the cooktop) or an alarm, i.e. a specific time, at any point (see "Minute minder + Alarm"). If the display is dark, this sensor will not react until the oven is switched on.
	For switching the oven interior lighting on and off	If a menu is visible in the display or if a cooking process is running, touching  will switch the oven interior lighting on or off. If the display is dark, this sensor will not react until the oven is switched on. The oven interior lighting switches off after 15 seconds during a cooking process or remains constantly switched on, depending on the setting selected.
	To go back a step	

Touch display

The display can be scratched by pointed or sharp objects, e.g. pens. Only touch the touch display with your fingertips.

Touching the display with your finger creates a tiny charge which releases an electrical impulse. This impulse is recognised by the touch display.

The touch display is divided into three sections:

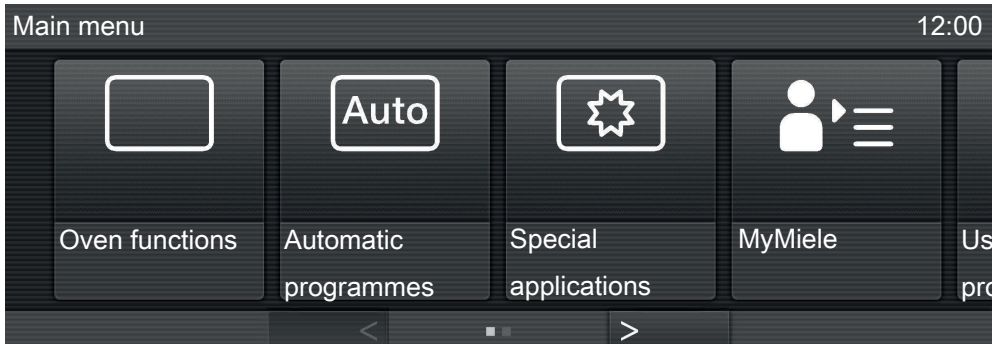

The menu path appears at the top left and shows you which menu or submenu you are in. Options within a menu are separated by a vertical line. If there is not enough space to show the whole menu path, additional options are indicated by ... I.







The time of day, alarm ⌚ and minute minder ⏰ are shown in the top right-hand corner of the display.

The middle section shows the current menu and options. You can scroll to the right or left by swiping your finger across the display.

The < and > arrow sensors at the bottom of the screen are used for scrolling to the left or right. The number of small squares between the arrows indicates the number of pages available and your position within the current menu.







Controls

Main menu

-  Oven functions
-  Automatic programmes
-  Special applications
-  MyMiele
-  User programmes
-  Settings
-  Maintenance

Symbols

The following symbols may appear in the display:

Symbol	Meaning
	Some settings, e.g. display brightness and buzzer volume, are selected using a bar chart.
	This symbol indicates that there is additional information and advice about using the oven. Select <i>OK</i> to access the information.
	The system lock or sensor lock is active (see "Settings - Safety"). The oven cannot be used.
	Alarm
	Minute minder
	Core temperature when using the food probe
	This indicates that there are more options available, which are not visible because there is not enough space in the display.

Operating principles

Each time you touch a possible option the relevant field lights up orange.

Selecting or calling up a menu

- Touch the field you want to select it.

Scrolling through menus

You can scroll left or right.

- Swipe the screen, i.e. place your finger on the Touch display and swipe it in the direction you want.
- Or: Using your finger, touch the arrows < and > to scroll left or right.

Exiting a menu

- Touch ↵, or touch an option in the menu path at the top of the screen, or touch ... I.

Depending on which menu you are in, this will take you back a level or back to the main menu.

Help function

The Help field appears with some functions and options.

- Touch the field.

Helpful information will then appear in text and pictures.

Controls

Entering numbers

You can enter numbers by scrolling through and touching the roller, or by using the numerical keypad.

To enter numbers using the roller:

- Swipe the roller up or down to select the number you want.

To enter numbers using the numerical keypad:

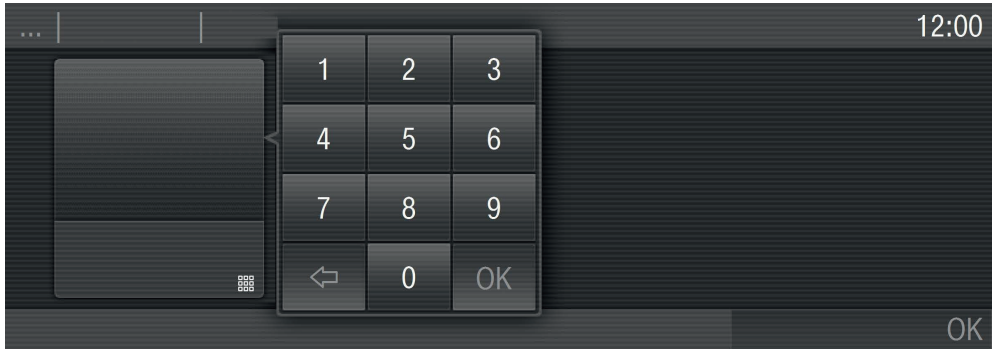

- Touch  in the bottom right of the input field.

The numerical keypad appears.

- Touch the required numbers.

Once you have entered a valid value, the *OK* sensor will light up green. The last figure entered can be deleted by using the arrow.

- Touch *OK*.

Entering letters

You can enter short names for your own user programmes using a keyboard.

- Touch the required letters or characters.
- Touch *Save*.

Model numbers

A list of the ovens described in these operating instructions can be found on the back page.

Data plate

The data plate located on the front frame of the oven is visible when the door is open.

On the data plate are printed the model number, serial number and the connection data (voltage/frequency/maximum rated load).

Have this information available if you need to contact Miele so that any issues can be rectified as quickly as possible.

Items supplied with delivery

The oven is supplied with:

- the operating and installation instructions for using the oven functions,
- a recipe booklet for Moisture Plus  and Automatic programmes,
- screws for fixing the oven to the housing unit,
- descaling tablets and a plastic tube with suction cup for descaling,
- various accessories.

Standard and optional accessories

Depending on model!
All ovens are supplied with shelf runners, a universal tray and baking and roasting rack (rack for short).
Depending on the model, Miele ovens may be supplied with the accessories listed below.

All accessories and cleaning and care products in these instructions are designed to be used with Miele ovens.

These are available to order via the Miele Webshop or directly from Miele (see end of this booklet for contact details).

Please state the model number of your oven and that of any accessories you wish to purchase.

Features

Shelf runners

Shelf runners for accessories (trays, racks, FlexiClip telescopic runners etc.) are fitted on either side of the oven cavity for shelf levels .

The shelf level numbers are indicated on the front of the oven frame.

Each shelf level has two rails, one above the other:

The accessories (e.g. the rack) are pushed into the oven between the two rails.

FlexiClip telescopic runners (depending on model) are fitted on the lower rail.

The shelf runners can be removed for cleaning (see "Cleaning and care").

Baking tray, universal tray and rack with non-tip safety notches

Baking tray HBB 71:

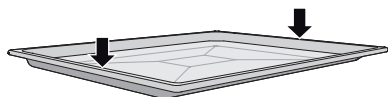

Universal tray HUBB 71:



Rack HBBR 72:



Insert these accessories into the shelf runners between the two rails of a shelf level.

Always place the rack with the loading surface in the lower position and the non-tip safety notches towards the back.

Non-tip safety notches are located on accessories to prevent the trays being pulled out completely when you only wish to pull them out partially. They also prevent trays from tipping.

- The non-tip safety notches are located in the middle of the short sides of the baking tray and universal tray.
- The non-tip safety notches are located towards the back of the short sides of the rack.



If you are using the universal tray with the rack on top, insert the tray between the rails of a shelf runner and the rack will sit on top of it.

FlexiClip telescopic runners HFC 72

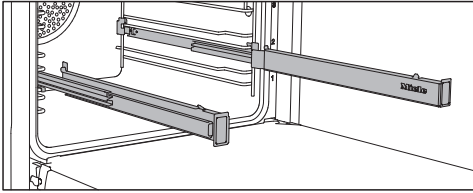

The FlexiClip telescopic runners can be attached to any shelf level.

Push the FlexiClip telescopic runners right into the oven before placing accessories on them.

The accessories will then automatically sit securely in between the stoppers at either end of each runner and be prevented from sliding off.

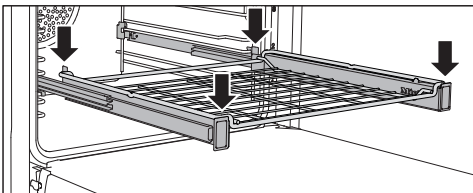
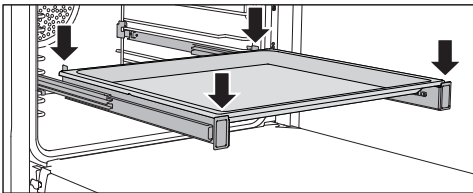

The FlexiClip runners can support a maximum load of 15 kg.

Fitting and removing the FlexiClip telescopic runners

 **Danger of burning!**
Make sure the oven heating elements are switched off and the oven interior is cool.

The FlexiClip telescopic runners are fitted in between the two rails that make up a shelf level.

The telescopic runner with the Miele logo must be fitted on the right.

When fitting or removing the telescopic runners, do **not** extend them.

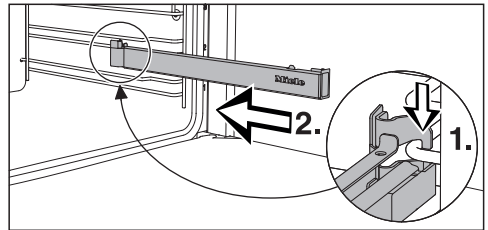

- Hook the FlexiClip telescopic runner onto the bottom rail of a shelf level at the front (1.) and push it along the rail into the oven interior (2.).

Features

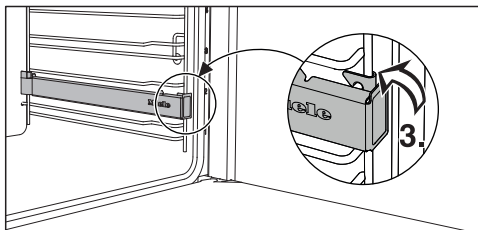

- Then secure the telescopic runner to the bottom of the two rails as illustrated (3).

If the telescopic runners are difficult to pull out after fitting, you may need to pull firmly on them once to release them.

To remove a FlexiClip telescopic runner:

- Push the FlexiClip telescopic runner all the way in.

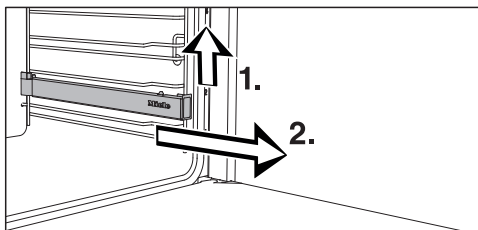

- Remove the FlexiClip telescopic runner by raising it at the front (1) then pulling it forwards along the rail and out (2).

Round baking tray HBF 27-1



The round baking tray is suitable for cooking pizzas, flat cakes made with yeast or whisked mixtures, sweet and savoury tarts, baked desserts, and can also be used for frozen cakes.

The surface has been treated with PerfectClean enamel.

Gourmet perforated baking tray HBBL 71

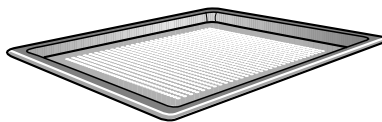

The Gourmet perforated baking tray has been specially developed for the preparation of baked goods made from yeast and quark/oil mixtures. The tiny perforations assist in browning the underside of baked goods. The tray can also be used for drying food.

The surface has been treated with PerfectClean enamel.

The **round perforated baking tray HBFP 27-1** can be used for the same things.

Baking stone HBS 60

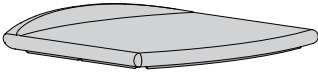

The baking stone is ideal for items which need a well-baked base such as pizza, quiche, bread, bread rolls and savoury snacks.

The baking stone is made from heat retaining fire brick and is glazed. Place it directly on the rack.

A paddle made of untreated wood is supplied with it for placing food on the baking stone and taking it off.

Grilling and roasting insert HGBB 71

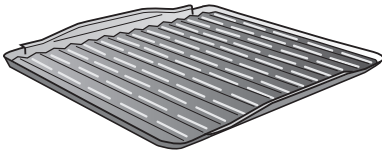

The grilling and roasting insert should be placed in the universal tray when grilling or roasting.

The juices from the food being cooked collect under the insert. This prevents them from spitting and making the oven dirty. The juices can then be used for making gravy and sauces.

The surface has been treated with PerfectClean enamel.

HUB Gourmet oven dishes HBD Gourmet oven dish lids

Unlike other oven dishes, the Miele Gourmet oven dishes can be placed in the oven directly on the shelf runners. They have non-tip safety notches like the rack to prevent them being pulled out too far.

The surface of the oven dishes has a non-stick coating.

Gourmet oven dishes are available in two sizes. The width and the height are the same for both.

Suitable lids are available separately. Please quote the model number when ordering a lid.

Depth: 22 cm

HUB 5000-M
HUB 5001-M *



HBD 60-22

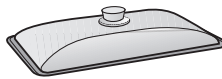

Depth: 35 cm

HUB 5000-XL
HUB 5001-XL *

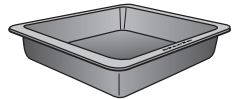

HBD 60-35

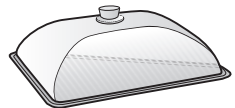

* Suitable for use on induction cooktops

Features

Food probe

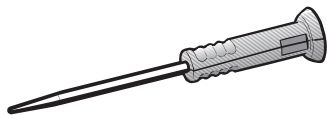

Using the wireless food probe enables the temperature during the cooking process to be monitored simply and accurately (see "Roasting - Food probe"). The food probe is stored in a holder in the door.

The food probe can suffer damage when the oven door is closed if it is not pushed right into its holder. Place it back in its holder after each use. Make sure you push it right into the holder.

Opener

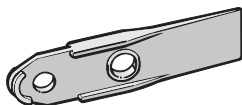

The opener is used for removing the cover from the lighting in the sides of the oven.

It can also be used for levering the door open in the event of a power outage. To do so, push the opener at an angle into the gap between the control panel and the door at the same height as the ↩ sensor.

Descaling tablets, plastic tube with suction cup

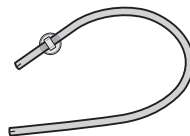

These are required for descaling the appliance.

Handle HEG

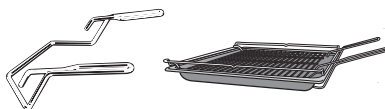

The handle makes it easier to take the universal tray, baking tray and rack out of the oven, or to put them into it. The two prongs at the top go inside the tray or above the rack, and the U-shape supports underneath.

Original Miele all purpose microfibre cloth

Light soiling and fingerprints can be easily removed with the microfibre cloth.

Original Miele oven cleaner

The Original Miele oven cleaner is suitable for removing very stubborn soiling. It is not necessary to pre-heat the oven beforehand.

Oven controls

The oven controls enable you to use the various cooking functions to bake, roast and grill.

They are also used for:

- Time of day display
- Minute minder
- Switching cooking processes on and off automatically
- Moisture Plus cooking
- Automatic programmes
- the creation of User programmes,
- Settings that can be customised

Oven safety features

System lock

The system lock prevents the oven from being used unintentionally (see "Settings - System lock").

The system lock will remain activated even after an interruption to the power supply.

Sensor lock for the oven

The sensor lock prevents the oven being switched off by accident or settings being altered whilst food is cooking. Once activated, the sensor lock deactivates the sensors and fields in the display a few seconds after a programme has been started (see "Settings – Safety – Sensor lock").

Safety switch-off

The oven switches itself off automatically if it is used for an exceedingly long period. The length of time depends on the oven function being used.

Cooling fan

The cooling fan comes on automatically when a cooking programme is started. The cooling fan mixes hot air from the oven cavity with cool room air before venting it out into the kitchen through vents located between the appliance door and the control panel.

The cooling fan will continue to run for a while after the oven has been switched off to prevent any humidity building up in the oven, on the control panel or in the oven housing unit.

The cooling fan will switch itself off automatically after a certain period of time (see "Settings – Cooling fan run on").

Vented oven door

The door panes have a heat-reflective coating.

When the oven is operating, air is passed through the door to keep the outer pane cool.

The door can be removed and dismantled for cleaning (see "Cleaning and care").

Features

Door lock for Pyrolytic cleaning

For safety reasons, the door is locked as soon as the Pyrolytic cleaning programme is started. After the Pyrolytic cleaning programme has finished, the door will remain locked until the temperature in the oven has fallen below 280 °C.

PerfectClean treated surfaces

Surfaces treated with PerfectClean enamel are characterised by their exceptional non-stick properties and ease of cleaning.

Food can be taken off easily, and soiling from baking and roasting is simple to remove.

You can cut up food on surfaces treated with PerfectClean enamel.

However, do not use ceramic knives as these will scratch the PerfectClean surface.

Surfaces treated with PerfectClean enamel can be cleaned as you would clean glass.

Read the instructions in "Cleaning and care" so that the benefits of the non-stick properties and easy cleaning are retained.

The following have been treated with PerfectClean enamel:

- Universal tray
- Baking tray
- Grilling and roasting insert
- Gourmet perforated baking tray
- Round baking tray
- Round perforated baking tray

Pyrolytic accessories

The following accessories can be left in the oven during the Pyrolytic cleaning programme:

- Shelf runners
- FlexiClip telescopic runners
- Rack

See "Cleaning and care" for more information.

General settings

 The oven must be built into its housing unit before it can be used.

The oven will switch on automatically when it is connected to the electricity supply.

Welcome screen

The Welcome (Willkommen) greeting will appear in the display, and you will then be requested to select some basic settings which are needed before the appliance can be used.

- Follow the instructions in the display.

Setting the language

- Select the language you want.
- Confirm with *OK*.

Selecting the country

- Select the country you want.
- Confirm with *OK*.

Setting the date

You can enter numbers by scrolling through and touching the roller, or by using the numerical keypad.

- Set the day, month and year.
- Confirm with *OK*.

Setting the time of day

You can enter numbers by scrolling through and touching the roller, or by using the numerical keypad.

- Set the time of day in hours and minutes.
- Confirm with *OK*.

The time of day can be displayed in the 12-hour format (see "Settings - Time of day - Clock format").

Using for the first time

Time of day display

You will then be asked when you want the time of day to appear in the display when the oven is switched off (see "Settings - Time of day - Display"):

– On

The time is always visible in the display.

– Off

The display appears dark to save energy. Some functions are limited.

– Night dimming

The time only appears in the display between 5:00 and 23:00. It switches off at night to save energy.

■ Select the option you want.

■ Confirm with *OK*.

Some information about energy consumption will appear in the display.

■ Confirm with *OK*.

■ Follow any further instructions in the display.

Set up successfully completed will appear.

■ Confirm with *OK*.

The oven is now ready to use.

If you have selected the wrong language by mistake, proceed as described in "Settings - Language ".



Heating up the oven for the first time and rinsing the steam injection system

New ovens can give off an unpleasant smell on first use. Heating up the oven for at least one hour with nothing in it will get rid of this smell. It is a good idea to rinse the steam injection system at the same time.

Ensure that the kitchen is well ventilated while the appliance is being heated up for the first time. Close doors to other rooms to prevent the smell spreading throughout the house.

- Remove any protective wrapping and sticky labels from the oven.
- Before heating the oven up, wipe the interior with a damp cloth to remove any dust or bits of packaging that may have accumulated in the oven cavity during storage and unpacking.
- Fit the FlexiClip telescopic runners (available to order) to the shelf runners and insert all trays and the rack.
- Switch the oven on with the On/Off sensor .

The main menu will appear.

- Select Oven functions .
- Select the Moisture Plus  function.

The recommended temperature will appear (160 °C).

The oven heating, lighting and cooling fan will switch on.

- Set the maximum possible temperature (250 °C).
- Confirm with OK.
- Select Automatic burst of steam.

The prompt to draw in water then appears.

- Fill a suitable container with the required amount of fresh tap water.
- Open the door.
- Pull the water intake pipe forwards (located below the control panel on the left).

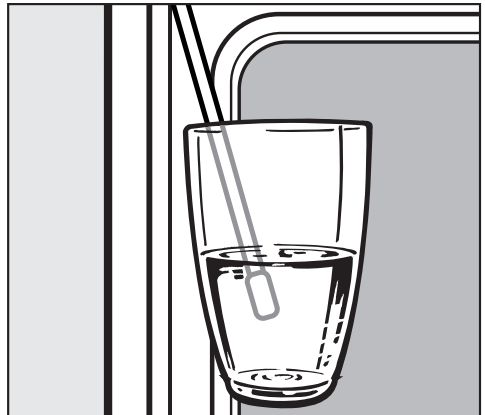

- Immerse the end of the water intake pipe in the container with tap water.
- Confirm with OK.

The water intake process will begin.

The amount of water actually drawn up into the oven may be less than the amount specified as required, leaving a small amount in the container.

- Remove the water container after the water intake process.

Using for the first time

- Confirm the message telling you that the process is complete with *OK*.
- Close the door.

The message will then disappear.

You will hear the pump briefly as the remaining water in the water intake pipe is drawn into the oven.

After a short time, a burst of steam is injected automatically.

 **Risk of injury!**
Steam can cause scalding.
Do not open the door during a burst of steam.



Heat up the oven for at least one hour.

After at least an hour:

- Switch the oven off with the On/Off sensor .

After heating up for the first time

 **Danger of burning!** Allow the oven to cool down before cleaning by hand.

- Switch the oven on with the On/Off sensor .
- Switch the oven lighting on with the  sensor.
- Take all accessories out of the oven and clean them by hand (see "Cleaning and care").
- Clean the oven interior with a clean sponge and a solution of warm water and washing-up liquid or a damp microfibre cloth.
- Dry all surfaces with a soft cloth.
- Switch the interior lighting and the oven off.

Leave the oven door open until the oven interior is completely dry.

Calling up the "Settings" menu

From the main menu:

- Select  Settings.

You can check them or change them.

Settings cannot be altered while a cooking programme is in progress.

Changing and saving settings

- Select  Settings.
- Swipe across the screen until the setting you want appears, then touch it to select it.



The settings which are currently selected will have a coloured frame around them.

- Swipe across the screen until the option you want appears, then touch it to select it.
- Confirm with *OK*.

The setting is now saved.

Settings

Settings overview



Menu option	Possible settings
Language 	... / deutsch / english / ... Country
Time	Display [On / Off * / Night dimming] Clock type [Analogue * / Digital] Clock format [24 h * / 12 h (am/pm)] Set
Date	
Lighting	On / On for 15 seconds *
Start screen	Main menu Oven functions Automatic programmes Special applications MyMiele User programmes
Brightness	■■■■■▶■■■■
Volume	Buzzer tones Keypad tone Welcome melody
Units	Weight [g * / lb / lb/oz] Temperature [°C * / °F]
Cooling fan run-on	Time-controlled Temperature-controlled *
Pyrolytic	With reminder Without reminder *
Recommended temperatures	
Safety	System lock  [On / Off *] Sensor lock [On / Off *]
Catalyser	■■■■■▶■■■■
Showroom programme	Demo mode [On / Off *]
Factory default	Settings User programmes Recommended temperatures MyMiele

* Factory default

Language

You can set the language and the country you want.







After selecting and confirming your choice, the language you have selected will appear in the display.

Useful tip: If you have selected the wrong language by mistake, select  Settings and the  symbol to get back to the Language  menu.

Time of day

Display

Select how you want the time of day to appear in the display when the oven is switched off:

- On
The time of day always appears in the display. You can operate the sensors directly and open the door , switch the lighting  on and off and use the Alarm + Minute minder  functions.
- Off
The display is switched off to save energy. The oven has to be switched on before you can open the door with the  sensor. This also applies to using the Alarm + Minute minder  functions and the lighting .
- Night dimming
To save energy, the lighting is only shown between 05:00 and 23:00. The rest of the time the display is dark and you have to switch the oven on in order to use it.

Clock display

You can choose from an analogue clock face or a digital (h:min) display.

The date will also appear in the digital clock display.

Clock format

You can select the clock format for the time of day:

- 24 h
The time of day is shown in the 24-hour format.
- 12 h (am/pm)
The time of day is shown in the 12-hour format.

Setting

Set the hours and the minutes.

If there is a power cut, the current time of day will reappear once power has been restored. The time is stored in memory for about 200 hours.

Synchronise

This menu option only appears if you are connected to the Miele@home system (available in selected countries only).

Settings

Date

Set the date.

When the oven is switched off, the date only appears if the oven is set to "Time of day – Clock type – Digital".

Lighting

- On
The interior lighting is switched on during the entire cooking period.
- On for 15 seconds
The oven lighting turns off 15 seconds after a programme starts. Touching  switches it on for another 15 seconds.

Start screen

The main menu will appear in the display when the oven is switched on. You can change this default setting so that, for instance, the oven functions or MyMiele entries appear in the display (see "MyMiele").

Brightness

The display brightness is represented by a bar with seven segments.



- Select **Darker** or **Lighter** to change the brightness of the display.

Volume

Buzzer tones

The volume setting is represented by a bar with seven segments.



Maximum volume is selected when all segments are filled. If none of the segments is filled, the tone is switched off.

- Select **Quieter** or **Louder** to adjust the volume.
- Select **On** or **Off** to switch the buzzer tones on or off.

Keypad tone

The volume setting is represented by a bar with seven segments.



Maximum volume is selected when all segments are filled. If none of the segments is filled, the tone is switched off.

- Select **Quieter** or **Louder** to adjust the volume.
- Select **On** or **Off** to switch the keypad tone on or off.

Welcome melody

The melody that sounds when you touch the On/Off sensor (ⓘ) can be switched on or off.

Units

Weight

- g
Weight in Automatic programmes is set using grams.
- lb
Weight in Automatic programmes is set using pounds.
- lb/oz
Weight in Automatic programmes is set using pounds and ounces.

Temperature

- °C
The temperature is displayed in degrees Celsius.
- °F
The temperature is displayed in degrees Fahrenheit.

Settings

Cooling fan run-on

The cooling fan will continue to run for a while after the oven has been switched off to prevent any humidity building up in the oven, on the control panel or in the oven housing unit.

- Temperature-controlled
The cooling fan is switched off when the oven compartment temperature drops below 70 °C.
- Time-controlled
The cooling fan switches off after a period of about 25 minutes.

Condensate can damage the oven housing unit, damage the worktop and lead to corrosion in the oven. If you leave food in the oven to keep it warm and have set the cooling fan to Time-controlled, moisture levels in the oven could increase, leading to condensation forming on the control panel and surrounding kitchen furniture and drops of moisture collecting under the worktop. Do not leave food in the oven to keep it warm if you have set the cooling fan to Time-controlled.

Recommended temperatures

If you frequently cook with different temperatures, it makes sense to change the recommended temperatures.

After selecting this option, a list of oven functions will appear in the display.

- Select the function you want.

The recommended temperature will appear together with the range within which it can be changed.

- Change the recommended temperature.
- Confirm with *OK*.

Pyrolytic cleaning

- With reminder

A reminder to run the Pyrolytic cleaning programme will appear in the display.

- Without reminder

You will not be reminded to run the Pyrolytic cleaning programme.

Safety

System lock

The system lock prevents the oven being switched on by mistake.

The system lock will remain activated even after a power failure.

Select **On** to activate the system lock.

The alarm and minute minder can still be used when the system lock is active.

- **On**
The system lock is now active. If you want to use the oven, switch it on and touch the  symbol for at least 6 seconds.
- **Off**
The system lock is not active. You can use the oven as normal.

Sensor lock

The sensor lock prevents a cooking process being switched off or changed while it is running. Once activated, the sensors and fields in the display are locked a few seconds after a programme has started.

- **On**
The sensor lock is active. You must touch the  symbol for at least 6 seconds to use the sensors again. The sensor lock is then deactivated for a short period.
- **Off**
The sensor lock is not active. All sensors react to touch as normal.

Settings

Catalyser

The level of odour reduction is represented by a bar with seven segments.



Maximum odour reduction is selected when all segments are filled. If none of the segments is filled, the catalyser is switched off.

- Select **Minimum** or **Maximum** to change the level of odour reduction.
- Select **On** or **Off** to turn the catalyser on and off.

Showroom programme

This function enables the oven to be demonstrated in showrooms without heating up. It should not be set for domestic use.

Demo mode

If you switch the oven on whilst it is in Demo mode, the following message will appear in the display: Demo mode is switched on. The appliance will not heat up.

- On
Touch **OK** for at least 4 seconds to activate Demo mode.
- Off
Touch **OK** for at least 4 seconds to deactivate Demo mode. The oven can then be used as normal.

Factory default settings

- Settings
Any settings that you have altered will be reset to the factory default setting.
- User programmes
All User programmes will be deleted.
- Recommended temperatures
Recommended temperatures which have been changed will be reset to the factory default settings.
- MyMiele
All MyMiele entries will be deleted.

You can personalise your oven using the MyMiele  function by inputting frequently used processes.

It is particularly useful with Automatic programmes as you do not need to work through every screen in order to start your programme.





You can also set processes that you have entered into MyMiele to appear in the Start screen (see "Settings – Start screen").

Adding an entry

You can add up to 20 entries.

- Select MyMiele .
- Select Add entry.

You can select options listed in the following categories:

- Oven functions 
- Automatic programmes 
- Special applications 
- User programmes 

- Confirm with *OK*.

The selected item and its respective symbol will appear in the list.

- Proceed as above for further entries as required. You can only choose options that have not already been selected.



MyMiele

Editing MyMiele

After selecting **Edit** you can

- add entries as long as MyMiele contains fewer than 20 entries,
- delete entries,
- sort entries as long as MyMiele contains more than 4 entries.



Deleting entries

- Select MyMiele  .
- Select **Edit**.
- Select **Delete** entry.
- Select the entry that you want to delete.
- Confirm with **OK**.

The entry will then be removed from the list.

Sorting entries

The order can be rearranged as long as there are more than 4 entries.

- Select MyMiele  .
- Select **Edit**.
- Select **Sort** entry.
- Select the entry.
- Select the position you want to move it to.
- Confirm with **OK**.

The entry will now appear in the position you want it in.

Minute minder + Alarm

Using the  sensor, you can set a minute minder duration to time any activity in the kitchen, e.g. boiling eggs, or an alarm for a specific time.

Two alarms can be set simultaneously, two minute minder durations or an alarm and a minute minder duration.

Using the alarm

The alarm can be used to specify a particular time for a buzzer to sound.

Setting the alarm



If Time – Display – Off has been selected, you will need to switch the oven on before you can set the alarm. The time for the alarm will now appear in the display when the oven is switched off.

- Select .
- Select New alarm.
- Set the time for the alarm.
- Confirm with *OK*.

When the oven is switched off, the alarm time and  will appear in the display instead of the time of day.

If you are cooking at the same time or if you are in a different menu, the alarm time and  will appear in the top right-hand corner of the display.

At the set alarm time

-  will flash next to the time in the display.
- a buzzer will sound if the buzzer is switched on (see "Settings - Volume - Buzzer tones").
- Touch  or the alarm symbol in the top right-hand corner of the display.

The buzzer will stop and the symbols in the display will go out.

Changing an alarm

- Select the alarm in the top right-hand corner of the display or select  and then the alarm you want.

The alarm selected appears.

- Set the new time for the alarm.
- Confirm with *OK*.

The altered alarm is now saved and will appear in the display.

Deleting an alarm

- Select the alarm in the top right-hand corner of the display or select  and then the alarm you want.

The alarm selected appears.

- Select *Reset*.
- Confirm with *OK*.

The alarm will be deleted.

Minute minder + Alarm

Using the minute minder

The minute minder can be used to time other activities in the kitchen, e.g. boiling eggs.

The minute minder can also be used at the same time as a cooking programme for which the start and finish times have been set, e.g. as a reminder to stir a dish or add seasoning etc.

A maximum minute minder duration of 9 hours, 59 minutes and 59 seconds can be set.

Useful tip: Use the minute minder in Moisture Plus  to remind you to inject the bursts of steam manually at the desired time.

Setting the minute minder

If you want to use the minute minder and Time – Display – Off has been set, you will need to switch the oven on before you can set the minute minder. The minute minder can then be seen counting down in the display when the oven is switched off.



Example: You want to boil some eggs and set a minute minder time of 6 minutes and 20 seconds.

- Select .
- Select New minute minder time.
- Set the minute minder time you require.
- Confirm with *OK*.

When the oven is switched off, the minute minder time counts down in the display and  appears instead of the time of day.

If you are cooking at the same time or if you are in a different menu, the minute minder time and  will appear in the top right-hand corner of the display.

At the end of the minute minder time

-  flashes.
- the time will count upwards.
- a buzzer will sound if the buzzer is switched on (see "Settings - Volume - Buzzer tones").
- Touch  or the minute minder time in the top right-hand corner of the display.

The buzzer will stop and the symbols in the display will go out.

Changing the time set for the minute minder

- Select the minute minder duration in the top right-hand corner of the display or select  and then the duration you want.

The minute minder time selected appears.

- Set the new minute minder time you require.
- Confirm with *OK*.

The changed minute minder is saved and will count down in seconds.

Cancelling the time set for the minute minder

- Select the minute minder duration in the top right-hand corner of the display or select  and then the duration you want.







The minute minder time selected appears.

- Select *Reset*.
- Confirm with *OK*.







The minute minder is now cancelled.

Overview of functions

Your oven has a range of functions for preparing a wide variety of recipes.





Oven function	Recommended temperature	Temperature range
Fan Plus  This function is used for baking and roasting on different levels at the same time. A lower temperature can be selected than when using Conventional Heat  as the fan distributes the heat around the oven compartment straight away.	160 °C	30–250 °C
Moisture Plus  For baking and roasting with moisture injection.	160 °C	130–250 °C
Intensive Bake  For baking cakes, tarts, pies, quiches and pizzas that require a crisper base or moist toppings. Intensive Bake is not suitable for baking thin biscuits or for roasting as the juices will become too dark.	170 °C	50–250 °C
Auto Roast  This is used for roasting. The oven heats initially to a high temperature (230 °C) which seals the meat to keep it succulent and tasty. As soon as this temperature has been reached, the oven temperature automatically drops back down to the pre-selected temperature for continued roasting.	160 °C	100–230 °C
Conventional Heat  For baking and roasting traditional recipes, preparing soufflés and cooking at low temperatures. If using an older recipe or cookbook, set the oven temperature for Conventional Heat 10 °C lower than that recommended. This won't change cooking times.	180 °C	30–280 °C

Overview of functions

Oven function	Recommended temperature	Temperature range
Top Heat  Use this function towards the end of cooking to brown the top of food.	190 °C	100–250 °C
Bottom Heat  Use this function towards the end of cooking to reheat or brown the base of a cake, quiche or pizza.	190 °C	100–280 °C
Full Grill  For grilling and toasting bread, open sandwiches etc. and browning baked dishes. The grill is ready for use when the entire top heat/grill element glows red.	240 °C	200–300 °C
Economy Grill  For grilling smaller quantities of thin cuts (e.g. steak) and for browning small baked dishes. Only the inner part of the heating element is switched on in order to create the heat required.	240 °C	200–300 °C
Fan Grill  For grilling thicker cuts of meat (e.g. chicken). Lower temperatures can be used than when using the Grill  function as the fan distributes the heat around the oven compartment straight away.	200 °C	100–260 °C
Gentle Bake  For small amounts e.g. of frozen pizza, bake-off rolls, cookies and for meat dishes and roasts. You can save up to 30% energy compared to cooking with a standard oven function as long as the door is kept shut during cooking.	190 °C	100–250 °C

Tips on saving energy

Cooking

- Remove any accessories from the oven that you do not require for cooking.
- Pre-heat the oven only if instructed to do so in the recipe or the cooking chart.
- Avoid opening the door during cooking.
- In general, if a range of temperatures is given, it is best to select the lower temperature and to check the food after the shortest given time.
- It is best to use dark baking tins and containers with a matt finish made from non-reflective materials (enamelled steel, ovenproof glassware, non-stick coated cast aluminium). Shiny materials such as stainless steel or aluminium reflect heat, preventing it reaching the food efficiently. Do not cover the oven floor or the rack with heat-reflective aluminium foil.
- Observe cooking durations to avoid energy wastage when cooking food.
- Wherever possible set the cooking duration, or use a food probe. Make use of the Automatic programmes if your oven has them.
- Fan Plus  can be used for cooking many types of food. Because the fan distributes the heat to food straight away, it allows you to use a lower temperature than you would with Conventional Heat . It also enables you to cook on several shelf levels at the same time.
- Gentle Bake  is an innovative function that makes optimum use of residual heat. You can save up to 30% energy compared to cooking with a standard oven function as long as the door is kept shut during cooking.
- Fan Grill  can be used for a wide variety of food. With Fan Grill you can use lower temperatures than with other grill functions which use the maximum temperature setting.
- Whenever possible you should cook several dishes at the same time. Place them next to each other in the oven or on different shelf levels.
- Dishes which you are unable to prepare at the same time should, if possible, be cooked one after the other in order to make use of existing heat in the oven.

Using residual heat

- The temperature in cooking programmes using temperatures above 140 °C which take longer than 30 minutes can be turned down to the lowest possible temperature about 5 minutes before the end of cooking. The residual heat is sufficient to complete the cooking process. Do not switch the oven off (see "Warning and safety instructions").
- If you have set a duration for a cooking programme, the oven heating elements will switch off automatically shortly before the end of cooking and Energy saving phase will appear in the display. The residual heat in the oven is sufficient to complete the cooking process.
- If you are using the Miele food probe to cook food, the oven heating elements will switch off automatically shortly before the end of cooking. The residual heat in the oven is sufficient to complete cooking and Energy saving phase will appear in the display.
- If you wish to run the Pyrolytic cleaning programme, it is best to start it immediately after a cooking programme. The residual heat in the oven will help reduce the amount of energy required to run the programme. To avoid soiling baking on the door, ensure you remove any soiling from it before running the Pyrolytic cleaning programme.

Settings

- Switch the clock display off if you wish to reduce energy usage (see "Settings").
- Set the oven lighting so that it switches off automatically during a programme after 15 seconds. It can be switched on again at any time by touching .

Energy save mode

- The oven will switch itself off automatically to save energy if a programme is not being run and controls have not been operated. The time of day will appear in the display or the display will remain dark (see "Settings").

Operation

Basic operation

- Switch the oven on.

The main menu will appear.

- Place the food in the oven.
- Select Oven functions .
- Select the function you want.

The oven function and recommended temperature will appear.

The oven heating, lighting and cooling fan will switch on.

- Change the recommended temperature if necessary.

The recommended temperature will be automatically accepted within a few seconds. If required, select **Change** to go back to the temperature selection option (see "Using the oven - further functions - Changing the temperature").

- Confirm with *OK*.

The required and the actual temperature will appear.

You will see the temperature increasing. A buzzer will sound when the selected temperature is first reached (See "Settings - Volume - Buzzer tones").

After the cooking process:

- Remove the food from the oven.
- Switch the oven off.

Cooling fan

The cooling fan will continue to run for a while after the oven has been switched off to prevent any humidity building up in the oven, on the control panel or in the oven housing unit.

The cooling fan will switch itself off automatically after a certain period of time (see "Settings – Cooling fan run on").





Using the oven - further functions

You have placed the food in the oven, selected a function and set the temperature.

You can select cooking durations and further settings from Open further settings.

- Select Change.
- Select Open further settings.

The following options will then appear:

- Duration
- Core temperature (This only appears if you are using the food probe. You cannot set a cooking duration when using the food probe.)
- Finish at
- Start at (only appears after a Duration or Finish at has been set.)
- Rapid Heat-up (This only appears if a temperature of more than 100 °C has been set for Fan Plus , Auto Roast , Conventional Heat  or Moisture Plus .)
- Crisp function (Moisture reduction for making items crispy on the outside or baking deep filled fresh fruit cakes.)
- Change type of heating (This option only appears with Moisture Plus . You can combine bursts of steam with another type of heating.)
- Change function (You can change the cooking function during operation.)

Using the oven - further functions

Changing the temperature

As soon as a cooking function is selected, a recommended temperature will appear in the display together with its possible range (see "Overview of functions").

- If the recommended temperature is suitable for your recipe, confirm with *OK*.
- If it is not suitable for your recipe, you can change it for this particular cooking programme.

You can also permanently reset the recommended temperature to suit your personal cooking practices (See "Settings - Recommended temperatures").

Example: You have selected Fan Plus  and 170 °C and can see the temperature increasing.





You want to reduce the target temperature to 155 °C.

- Select *Change*.
- Change the temperature.
- Confirm with *OK*.

The altered target temperature is saved. The target and actual temperatures are displayed.

Rapid Heat-up

Rapid Heat-up can be used to speed up the heating-up phase.

The Rapid Heat-up function switches on automatically if you set a temperature of more than 100 °C for Fan Plus , Auto Roast , Conventional Heat  or Moisture Plus .

Do not use Rapid Heat-up to pre-heat the oven when baking pizzas or delicate mixtures (e.g. small baked goods with a high sugar content, choux pastries, sponges). These will get brown too quickly on the top.

You can switch-off "Rapid Heat-up" for a relevant cooking process.

Using the oven - further functions

Rapid Heat-up

– On

The top and ring heating elements come on together with the fan to enable the oven to reach the required temperature as quickly as possible.

– Off

Only the heating elements for the oven function selected are switched on.

To switch off the Rapid Heat-up function:

- Select Change.
- Select Open further settings.
- Select Rapid Heat-up.

Off will appear in the Rapid Heat-up field.

- Confirm with OK.

Rapid Heat-up has been deactivated.

Instead of Rapid Heat-up, Heating-up phase will appear.

Pre-heating the oven

It is only necessary to pre-heat the oven in a few instances.

Most dishes can be placed in a cold oven. They will then make use of the heat produced during the heating-up phase.

Pre-heat the oven when cooking the following food with the following oven functions:

Fan Plus

- dark bread doughs
- beef sirloin joints and fillets

Conventional Heat

- cakes or biscuits with a short baking time (up to 30 minutes)
- delicate mixtures (e.g. sponges)
- dark bread doughs
- beef sirloin joints and fillets
- Select the required oven function and the temperature.
- Rapid Heat-up should be switched off when baking pizza, biscuits and small cakes.
- Wait for the heating-up phase to finish.

A buzzer will sound when the set temperature is reached as long as the buzzer is set (see "Settings - Volume - Buzzer tones").

- Place the food in the oven.

Using the oven - further functions

Using the Crisp function (moisture reduction)

It is a good idea to use this function when cooking items which are moist on the inside but which should be crispy on the outside, e.g. frozen chips, croquettes or pork with crackling.

It is also suitable for deep filled fresh fruit cakes, such as plum or apple cake.

You have placed the food in the oven, selected a function and set the temperature.

You can activate the "Crisp function" with any function. It must be activated separately for a cooking process. For best results, activate it at the beginning of the cooking process.

- Select Change.
- Select Open further settings.
- Select Crisp function.

On will appear in the Crisp function field.

- Confirm with OK.

Moisture reduction is now activated.

Changing the oven function

You can change the oven function during operation.

- Select Change.
- Select Open further settings.
- Select Change function.
- Select the function you want.

The new function will appear in the display together with its recommended temperature.

- Change the temperature if necessary.
- Confirm with OK.

The oven function has been changed.

The times already entered will be kept.

Using the oven - further functions

Setting durations

You have placed the food in the oven, selected a function and set the temperature.

By entering **Duration**, **Finish at** or **Start at** you can automatically switch the cooking programme off or on and off.

– **Duration**

Enter the cooking duration you require. Once the duration set has elapsed, the heating will switch off automatically. The maximum duration which can be set is 12:00 hours.

A cooking duration cannot be entered if you are using the food probe. When using the food probe, the cooking duration is determined by when the set core temperature is reached.

– **Finish at**

You can specify when you want the programme to finish. The oven heating will switch off automatically at the time you set.

A **Finish at** time cannot be entered if you are using the food probe. When using the food probe, the end time is determined by when the set core temperature is reached.

– **Start at**

Set the time at which you want cooking to start. The oven will switch on automatically at the time you have set.

Start at can only be used together with **Duration** or **Finish at**, except when using the food probe.

Switching off automatically

Example: It is 11:45. The food takes 30 minutes to cook and should be ready at 12:15.

Select **Duration** and set 00:30 h or select **Finish at** and set the time to 12:15.

The oven will switch off automatically after this duration has elapsed or when the time set has been reached.

Setting the "Duration"

- Select **Change**.
- Select **Open further settings**.
- Set the cooking duration.
- Confirm with **OK**.

Setting the "Finish at" time

- Select **Change**.
- Select **Open further settings**.
- In the **Finish at** field, set the time at which the food should be ready.
- Confirm with **OK**.

Using the oven - further functions

Switching on and off automatically

We recommend using automatic switching on and off when roasting. However, do not delay the start for too long when baking as the cake mixture or dough will dry out, and the raising agents will lose their effectiveness.

To switch a cooking programme on and off automatically, you have a choice of how to enter the time parameters:

- Duration and Finish at
- Duration and Start at
- Finish at and Start at

Example: It is 11:30. The food takes 30 minutes to cook and should be ready at 12:30.

- Select **Change**.
- Select **Open further settings**.
- Set a duration of 00:30 h in the **Duration** field.
- Set a time of 12:30 in the **Finish at** field.
- Confirm with **OK**.

The **Start at time** will be calculated automatically. **Start at 12:00** will appear in the display.

The oven will switch on automatically when this time is reached.

Sequence of a programme that switches on and off automatically

Up until the start time the function, the selected temperature, **Start at** and the start time will appear in the display.

After the programme has started, you can follow the heating-up phase in the display until the required temperature has been reached.

Once this temperature is reached, a buzzer will sound if this option has been switched on (see "Settings - Volume - Buzzer tones").

After the heating-up phase, the time remaining will appear in the display.

You can follow the time counting down in the display. The last minute counts down in seconds.

At the end of the programme a buzzer will sound if this option has been switched on (see "Settings - Volume - Buzzer tones").

The oven heating and lighting will switch off. **Process finished** will appear in the display.

You have the option of saving the programme as a **User programme** (see "User programmes") or increasing the duration of the programme via **Change**.

During the cooling down phase the cooling fan will continue to run for a while.

Using the oven - further functions

Changing an entered cooking time

- Select **Change**.

All options that can be changed will appear.

- Change to the time you want.
- Confirm with **OK**.

These settings will all be deleted in the event of a power cut.

Cancelling cooking

- Touch ↵ twice.

Cancel cooking? appears in the display.

- Select **Yes**.

The oven heating and lighting will switch off, and any set durations will be deleted.

Moisture Plus

Your oven is equipped with a steam injection system for cooking with moisture. Baking, roasting and cooking with Moisture Plus  guarantees optimised steam and air conduction for excellent cooking and browning results.

After selecting Moisture Plus , you need to set the temperature and the number of bursts of steam.

You can select:

- Automatic burst of steam
This requires enough water for one burst of steam. The burst of steam will be injected into the oven automatically after the heating-up phase.
- 1 burst of steam
2 bursts of steam
3 bursts of steam
You need to add the appropriate amount of water for the number of bursts of steam. You have to release the bursts of steam yourself.

Fresh tap water is taken into the steam system via the tube underneath the control panel on the left.

Liquids, other than water, can cause damage to the oven.

Only use tap water when cooking with the Moisture Plus function.

The water is injected as bursts of steam into the oven compartment during the cooking programme. The steam inlets are located at the rear left corner of the roof of the oven.

One burst of steam takes approx. 5–8 minutes. The number of bursts of steam and when they are injected will depend on the type of food being cooked:



- **Yeast mixtures** will rise better if steam is injected at the beginning of the programme.
- **Bread and rolls** also rise better if exposed to steam at the start. Injecting a burst of steam at the end of the programme will give the bread and rolls a glistening crust.
- When **roasting meat with a high fat content**, injecting steam at the beginning of roasting will help render the fat.

Additional moisture is not suitable for mixtures which already contain a lot of moisture, such as choux pastry and meringues, as the addition of steam does not allow them to dry out sufficiently.

Useful tip: See the recipe book for more information.

Cooking with the Moisture Plus function

It is quite normal for condensation to form on the inside of the door during steam injection. This will dissipate during the course of the cooking programme.

- Prepare the food and place in the oven if no pre-heating is required.
- Select Oven functions .
- Select the Moisture Plus  function.

The recommended temperature of 160 °C will appear.

The oven heating, lighting and cooling fan will switch on.

Setting the temperature

- Set the required temperature.
- Confirm with *OK*.

Setting the number of bursts of steam

- If you would like a burst of steam to be automatically injected into the oven after the heating-up phase, select *Automatic burst of steam*.
- If you would like to inject one or more bursts of steam manually at specific times, select 1 burst of steam, 2 bursts of steam or 3 bursts of steam.

When to add the bursts of steam

This option will only appear in the display after you have selected 1, 2 or 3 bursts of steam.

Useful tip: If you have selected more than one burst of steam, the second burst should be released at the earliest 10 minutes after starting the programme.

Manual bursts of steam

If you want to bake food such as bread or bread rolls in a pre-heated oven, it is best to release the steam manually. The first burst of steam should be released as soon as you have placed the food in the oven.

- To inject the bursts of steam yourself, select *Manual*. Use the minute minder  to remind yourself when to do this.

Time-controlled bursts of steam

- If you want to time when to release the bursts of steam, select *Time-controlled*.
- Set the time for each burst of steam. The oven will then release the steam at the specified times. The time counts down as soon as the programme is started.
- Confirm with *OK*.

The prompt to draw in water then appears.

Preparing and starting the water intake process

- Fill a suitable container with the required amount of fresh tap water.
- Open the door.
- Pull the water intake pipe forwards (located below the control panel on the left).

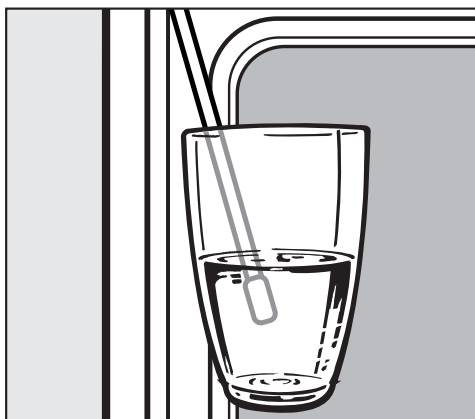

- Immerse the end of the water intake pipe in the container with tap water.
- Confirm with *OK*.

The water intake process will begin.

The amount of water actually drawn up into the oven may be less than the amount specified as required, leaving a small amount in the container.

The intake process can be interrupted and restarted at any time by selecting *Stop* or *Start*.

- Remove the water container after the water intake process.
- Confirm the message telling you that the process is complete with *OK*.
- Close the door.

You will hear the pump briefly as the remaining water in the water intake pipe is drawn into the oven.

The oven heating and the cooling fan will switch on. The required and actual temperatures will appear in the display.

You will see the temperature increasing. A buzzer will sound when the selected temperature is first reached (See "Settings - Volume - Buzzer tones").

If you have selected Time-controlled, the time at which to release the next burst of steam will appear in the display after the heating-up phase. If necessary, you can change this time by selecting Change.

Changing the type of heating

The Moisture Plus function  uses a combination of Fan Plus together with the addition of moisture.

You can use moisture with one of the following other types of heating:

- Conventional Heat
 - Intensive Bake
 - Auto Roast
- Select Change.
 - Select Open further settings.
 - Select Change type of heating.
 - Select the function you want.
 - Confirm with OK.

Cooking will be carried out using the different type of heating selected.

Injecting bursts of steam

Steam can cause scalding. Do not open the door during bursts of steam. Also, condensation on the sensors will cause them to have a slow reaction time.

Automatic burst of steam

Automatic burst of steam appears in the display.

Once the heating-up phase has been completed, the automatic burst of steam is injected.

The water will vaporise in the oven whilst steam is being released and **Burst of steam active** will appear in the display.

After the burst of steam **Burst of steam finished**, will appear in the display.

- Continue cooking until the end of the cooking duration.

1, 2 or 3 bursts of steam

Manual bursts of steam

When **Manual** has been selected, you can trigger bursts of steam once **Start Manual burst of steam** appears.

Please wait until the heating-up phase is completed to allow the steam to be distributed evenly by the warm air in the oven.

Useful tip: See the recipe book for tips on when to release the bursts of steam. Use the minute minder  to remind you when to release them.

- Select **Start Manual burst of steam**.

The burst of steam will be released and **Burst of steam active** will appear in the display.

- Proceed as described to inject further bursts of steam.

Burst of steam finished will appear in the display after each burst of steam.

- Continue cooking until the end of the cooking duration.

Time-controlled bursts of steam

The oven will release the steam after the specified amount of time.

Evaporating residual moisture

When cooking using the addition of moisture, the water will be equally distributed between the number of bursts of steam and used up as long as the programme is not interrupted.

However, if a programme using the addition of moisture is interrupted before all the bursts of steam have been injected, the water for these unused bursts of steam will remain in the system.

The next time Moisture Plus  or an Automatic programme with moisture is used *Evaporate residual moisture?* will appear in the display with the options *Skip* and *Yes*.

It is best to start the evaporation of residual water straight away so that only fresh water is used during a cooking programme.

The residual moisture evaporation process

The oven will heat up and the residual water in the oven cavity will evaporate.

Depending on the amount of water, this can take up to approximately 30 minutes.

Steam can cause scalding.
Do not open the door while the residual water is being evaporated.

The moisture will condense on the door and in the oven compartment and needs to be wiped off after the oven has cooled down.

Moisture Plus

Starting residual moisture evaporation immediately

Steam can cause scalding.
Do not open the door while the residual water is being evaporated.

- Select the Moisture Plus  function or an Automatic programme that uses moisture.

Evaporate residual moisture? appears in the display.

- Select Yes.

Evaporate residual moisture and a time then appear in the display.

The evaporation process will begin. The duration will count down in the display.

The duration displayed depends on the amount of water in the system. During the evaporation process, this duration may change depending on how much water is present.

At the end of the residual water evaporation process Process finished appears:

- Touch .

A cooking process using the Moisture Plus  function or an Automatic programme with moisture can now be carried out.

The moisture will condense on the door and in the oven compartment and needs to be wiped off after the oven has cooled down.

Skipping residual moisture evaporation

 Skipping the residual moisture evaporation process can, in certain cases, cause water to overflow into the oven cavity.

It is best not to cancel the evaporation process.

- Select the Moisture Plus  function or an Automatic programme that uses moisture.

Evaporate residual moisture? appears in the display.

- Select Skip.

A cooking process using the Moisture Plus  function or an Automatic programme with moisture can now be carried out.

You will be prompted to carry out the residual moisture evaporation process the next time you select the Moisture Plus  function, or an Automatic programme that uses moisture and when you turn the oven off.

Your oven has a wide range of Automatic programmes to enable you to achieve excellent results with ease. Simply select the appropriate programme for the type of food you are cooking and follow the instructions in the display.

List of food types

Automatic programmes are accessed via Automatic programmes **[Auto]**.

- Cakes
- Cookies/ Muffins
- Bread
- Bread mixes
- Bread rolls
- Pizza & Quiche
- Meat
- Game
- Poultry
- Fish
- Bakes/Gratins
- Frozen meals
- Desserts

Using Automatic programmes

From the main menu:

- Select Automatic programmes **[Auto]**.

A list of food types will appear in the display.

- Select the type of food.

The Automatic programmes available for the food type selected will then appear.

- Select the Automatic programme that you want to use.

Each step you need to take before starting the Automatic programme will appear in the display.

Depending on the Automatic programme selected, tips will appear about the following:

- Roasting or baking dish
- Shelf level
- Using the food probe
- The amount of water required for Automatic programmes with Moisture Plus
- Duration

- Follow the instructions in the display.

Useful tip: See the recipe booklet for a selection of Automatic programmes to try.

Automatic programmes

Notes on use

- When using the Automatic programmes, the recipes provided are designed as a guide only. You can use them for other similar recipes, including those using different quantities.
- The oven interior needs to be at room temperature before starting an Automatic programme.
- Some Automatic programmes require the addition of liquid during cooking. You will be prompted by a message in the display when this needs to be done (e.g. "Add liquid at ...").
- Some Automatic programmes require a pre-heating phase before food is placed in the oven. A prompt will appear to tell you when to add the food.
- The duration quoted for Automatic programmes is an estimate. It may increase or decrease depending on the programme. When using the food probe, the duration will be determined by when the core temperature is reached. The duration, in particular with meat, will vary depending on the initial temperature of the food.

Search

(Depending on language)

You can search by food type and by the name of the Automatic programme under Automatic programmes.

There is a full text search which can also be used to search for parts of words.

From the main menu:

- Select Automatic programmes .

A list of food types will appear in the display.

- Select Search.
- Use the keyboard to type in the search text, e.g. "Bread".

The number of hits will be shown in the bottom right of the display.

If no match is found, or if there are more than 40 matches, the hits field will be deactivated and you will need to change the search text.

- Select hits.

The food types and Automatic programmes available will then appear.

- Select the Automatic programme you want or the food type and then the Automatic programme.

The Automatic programme will start.

- Follow the instructions in the display.

User programmes

You can create and save up to 20 of your own programmes.

- Each one can have up to 10 cooking stages. This enables you to save your most frequently used recipes very accurately. In each stage you need to select settings such as function, temperature and duration or core temperature.
- You can specify the shelf level(s) for the food.
- You can enter the name of the programme for your recipe.

When you next select the programme, it will start automatically.

There are different ways of creating a User programme:

- At the end of an Automatic programme, save it as a User programme.
- After running a programme with a set duration, save it.

Then name the programme.

Creating a User programme

- Select User programmes .
- Select Create programme.

You can now specify the settings for cooking stage 1.

Follow the instructions in the display.

- Select and confirm the settings you want to change.

Depending on the cooking function selected, you can switch on the Rapid Heat-up and Crisp function functions via Open further settings.

Settings for the 1st cooking stage have now been set.

You can add more cooking stages, for example, if you want to add another cooking function to follow on from the first.

- If additional cooking stages are required, select Add and proceed as for the 1st cooking stage.
- When you have finished setting all the cooking stages, select Finish.

Finally set the shelf level(s) to be used.

- Select the shelf levels(s) you want.
- Confirm with OK.

A summary of your settings will appear in the display.

- Check the settings and touch OK to confirm or select Change to correct the settings.
- Select Save.
- Enter the programme name using the keyboard.

You can add a line break for longer programme names using the] symbol.

- Once you have entered the programme name, select **Save**.

A message will appear in the display confirming that the name has been saved.

- Confirm with **OK**.

You can start the saved programme immediately, delay the start or change the cooking stages.

The option **Change cooking stages** is described in "Changing User programmes".

Starting a User programme

- Place the food in the oven.
- Select **User programmes** .

The programme names will appear in the display.

- Select the required programme.

You can start the saved programme immediately, delay the start or display the cooking stages.

- **Start now**
The programme will start straight away and the oven heating will switch on.
- **Start later**
This option only appears if you are using the food probe. You can specify when you want the programme to start. The oven heating will switch on automatically at the time you set.

- **Finish at**
You can specify when you want the programme to finish. The oven heating will switch off automatically at the time you set.
- **Start at**
You can specify when you want the programme to start. The oven heating will switch on automatically at the time you set.
- **Display cooking stages**
A summary of your settings will appear in the display. You can alter the settings via **Change** (see "Changing User programmes").
- Select the required menu option.
- Confirm the message regarding which shelf level to use with **OK**.

The programme selected will begin automatically straight away or at the time set.

User programmes

Changing User programmes

Changing cooking stages

Cooking stages in an Automatic programme that you have renamed as a User programme cannot be changed.

- Select User programmes .

The programme names will appear in the display.

- Select Edit.
- Select Change programme.
- Select the required programme.
- Select Change cooking stages.

You can change the specified settings for a cooking stage or add more cooking stages to the programme.

- Change the programme as you wish (see "Creating a User programme").
- Check the settings and confirm with *OK*.
- Select *Save*.

The changes to your programme will be saved.

Changing a name

- Select User programmes .

The programme names will appear in the display.

- Select Edit.
- Select Change programme.
- Select the required programme.
- Select Change name.
- Change the name (see "Creating a User programme") and select *Save*.

A message will appear in the display confirming that the name has been saved.

- Confirm with *OK*.

The new name for your programme will be saved.

Deleting User programmes

- Select User programmes .

The programme names will appear in the display.

- Select Edit.
- Select Delete programme.
- Select the required programme.
- Confirm with OK.





The programme will be deleted.

You can delete all User programmes at once (see "Settings - Factory default - User programmes").

Baking





Eating food which has been cooked correctly is important for preventing food poisoning or other ailments. Only bake cakes, pizza, chips etc. until they are golden brown. Do not overcook them.

Oven functions

Depending on how the food is prepared, you can use Fan Plus , Intensive Bake , Moisture Plus  or Conventional Heat .

Bakeware

The choice of bakeware depends on the oven function and how the food is prepared.

- Fan Plus , Intensive Bake , Moisture Plus :
Baking tray, universal tray, bakeware made from ovenproof material.
- Conventional Heat :
Dark baking tins with a matt finish. Avoid using bright, shiny metal tins as they give an uneven and poor browning result and in some cases cakes might not cook properly.
- Always place baking tins on the rack. Position rectangular tins with the longer side across the width of the rack for optimum heat distribution and even baking results.
- When baking cakes with fresh fruit toppings and deep sponge cakes, place the tin on the universal tray to catch any spillages and keep the oven cleaner.

Baking paper, greasing

Miele accessories, e.g. the universal tray, are treated with PerfectClean enamel (see "Features").

Surfaces treated with PerfectClean enamel generally do not need to be greased or covered with baking paper.

Baking paper is only necessary when baking:

- anything with a high salt content (e.g. pretzels, bread sticks), because salt can damage the PerfectClean surface.
- meringues or sponges with a high egg white content
These are more likely to stick.
- frozen food cooked on the rack.

Notes on using the baking charts

In the charts the data for the recommended function is printed in bold.

Unless otherwise stated, the times given are for an oven which has not been pre-heated. With a pre-heated oven, shorten times by up to 10 minutes.

Temperature

As a general rule, select the lower temperature given in the chart.

Baking at temperatures higher than those recommended may reduce the cooking time, but will lead to uneven browning, and unsatisfactory cooking results.

Baking duration

Check if the food is cooked at the end of the shortest time quoted. To check if a cake is ready, insert a wooden skewer into the centre. It is ready if the skewer comes out clean, without dough or crumbs sticking to it.

Shelf levels

The shelf level on which you place your food for baking depends on the oven function and number of trays being used.

– **Fan Plus**

1 tray: level 2

2 trays: levels 1+3 / 2+4

3 trays: levels 1+3+5

The universal tray should be placed underneath the baking tray if you are using a universal tray and a baking tray on several levels at the same time.

Bake moist biscuits and cakes on a maximum of two levels at the same time.

– **Moisture Plus**

1 tray: Shelf level 2

– **Intensive Bake**

1 tray: Shelf level 1 or 2

















– **Conventional Heat**

1 tray: Shelf level 1 or 2



Baking

Baking charts

Creamed mixture

Cakes/Biscuits		 [°C]	 ⁵ ₁	 [min.]
Muffins (1 tray)		140–150 ²⁾	2	35–45
	 ¹⁾	150–160 ²⁾	2	30–40
Muffins (2 trays)		140–150 ²⁾	2+4	35–45 ⁵⁾
Small cakes (1 tray) *		150 ²⁾	2	30–40
	 ¹⁾	160 ^{2) 3)}	3	20–30
Small cakes (2 trays) *		150 ^{2) 3)}	2+4	25–35
Small cakes/Biscuits (1 tray)		140–150 ^{2) 4)}	2	25–35
		150–160 ^{2) 3) 4)}	3	15–25
Small cakes/Biscuits (2 trays)		140–150 ^{2) 4)}	2+4	25–35 ⁵⁾
Sand cake		150–160 ²⁾	2	60–70
		150–160 ^{2) 3) 4)}	2	60–70
Ring cake		150–160	2	50–60
		170–180	2	55–65

















 Function /  Fan Plus /  Conventional Heat



 Temperature / ⁵₁ Shelf level /  Duration



* The settings also apply for testing in accordance with EN 60350-1.

- 1) Switch the catalyser off before starting the programme. Select Settings – Catalyser – Off.
- 2) During the heating-up phase select Open further settings – Rapid Heat-up – Off.
- 3) Pre-heat the oven.
- 4) Select a function and set the temperature and then select Open further settings – Crisp function – On.
- 5) Take the baking trays out of the oven early if the food is sufficiently browned before the specified time has elapsed.

Creamed mixture

Cakes/Biscuits		 [°C]	 ⁵ 1	 [min.]
Foam cake (tray)		150-160 ¹⁾	2	30-40
		150-160 ^{1) 2)}	2	30-40
Marble, nut cake (tin)		150-160	2	60-80
		150-160	2	60-80
Fresh fruit cake, with meringue topping (tray)		150-160 ¹⁾	2	40-50
		170-180 ¹⁾	2	45-55
Fresh fruit cake (tray)		150-160	2	35-45
		160-170	2	35-55
Fresh fruit cake (tin)		150-160	2	55-65
		170-180 ^{1) 2) 3)}	2	35-45
Flan base		150-160 ¹⁾	2	25-35
		170-180 ^{1) 2)}	2	15-25

















 Function /  Fan Plus /  Conventional Heat

 Temperature / ⁵ Shelf level /  Duration



- 1) During the heating-up phase select Open further settings – Rapid Heat-up – Off.
- 2) Pre-heat the oven.
- 3) Select a function and set the temperature and then select Open further settings – Crisp function – On.

Baking

Rubbed in mixture

Cakes/Biscuits		 [°C]	 ⁵ 1	 [min.]
Small cakes/Biscuits (1 tray)		140–150 ²⁾	2	20–30
		160–170 ^{2) 3)}	3	15–25
Small cakes/Biscuits (2 trays)		140–150 ²⁾	1+3	20–30 ⁴⁾
Drop cookies (1 tray) *		140 ²⁾	2	30–45
	 ¹⁾	160 ^{2) 3)}	3	20–30
Drop cookies (2 trays) *		140 ²⁾	1+3	35–45 ⁴⁾
Flan base		150–160	2	35–45
		170–180 ³⁾	2	20–30
Streusel cake		150–160	2	45–55
		170–180	2	45–55
Cheese cake		150–160 ²⁾	2	80–95
		170–180 ²⁾	2	80–90
		150–160	2	70–90















 Function /  Fan Plus /  Conventional Heat /  Intensive Bake

 Temperature / ⁵ Shelf level /  Duration



* The settings also apply for testing in accordance with EN 60350-1.

- 1) Switch the catalyser off before starting the programme. Select Settings – Catalyser – Off.
- 2) During the heating-up phase select Open further settings – Rapid Heat-up – Off.
- 3) Pre-heat the oven.
- 4) Take the baking trays out of the oven early if the food is sufficiently browned before the specified time has elapsed.

Rubbed in mixture

Cakes/Biscuits		 [°C]	 ⁵ 1	 [min.]
Apple cake (baking tin Ø 20 cm) *		160 ¹⁾	2	90–100
		180 ¹⁾	1	80–95
Apple pie		160–170 ¹⁾	2	50–70
		170–180 ^{1) 2) 3)}	2	60–70
		160–170	2	50–70
Fresh fruit tart, glazed (tin)		150–160	2	55–75
		170–180	2	55–75
		150–160	2	55–65
Swiss apple pie (tray)		220–230 ²⁾	1	30–50
		180–190	1	30–50

 Function /  Fan Plus /  Conventional Heat /  Intensive Bake















 Temperature / ⁵ Shelf level /  Duration

* The settings also apply for testing in accordance with EN 60350-1.



- 1) During the heating-up phase select Open further settings – Rapid Heat-up – Off.
- 2) Pre-heat the oven.
- 3) Select a function and set the temperature and then select Open further settings – Crisp function – On.

Baking

Yeast mixtures and quark dough

















Cakes/Biscuits		 [°C]	 ⁵ ₁	 [min.]
Gugelhupf		150-160 ¹⁾	2	50-60
		160-170 ¹⁾	2	50-60
Stollen		150-160	2	45-65
		160-170	2	45-60
Streusel cake		150-160	2	35-45
		170-180 ²⁾	3	35-45
Fresh fruit cake (tray)		160-170	2	40-60
		170-180 ²⁾	3	40-60
Apple turnovers (1 tray)		150-160	2	25-30
		160-170	2 ³⁾	25-30
Apple turnovers (2 trays)		150-160	1+3	25-30 ⁴⁾

 Function /  Fan Plus /  Conventional Heat



 Temperature /  ⁵₁ Shelf level /  Duration

- 1) During the heating-up phase select Open further settings – Rapid Heat-up – Off.
- 2) Select a function and set the temperature and then select Open further settings – Crisp function – On.
- 3) For yeast dough. With quark dough use shelf level 3.
- 4) Take the baking trays out of the oven early if the food is sufficiently browned before the specified time has elapsed.

Yeast mixtures and quark dough

Cakes/Biscuits		 [°C]	 ⁵ ₁	 [min.]
White bread		180–190	2	35–45
		190–200	2	30–40
Wholegrain bread		180–190	2	55–65
		200–210 ¹⁾	2	45–55
Pizza (tray)		220–240	2	10–20
		220–240 ^{1) 2)}	2 ³⁾	10–25
		220–240	2 ³⁾	10–20
Onion tart		170–180	2	30–40
		180–190 ^{1) 2)}	2	25–35
		170–180	2	30–40
Proving yeast dough		35	⁴⁾	15–30
		35	⁴⁾	15–30













 Function /  Fan Plus /  Conventional Heat /  Intensive Bake

 Temperature / ⁵₁ Shelf level /  Duration



- 1) Pre-heat the oven.
- 2) Select a function and set the temperature and then select Open further settings – Crisp function – On.
- 3) For yeast dough. With quark dough use shelf level 3.
- 4) The dish can be placed on the oven floor. Depending on the size of the dish, you may need to remove the shelf runners. If using Conventional Heat , please also place the rack on the oven floor.

Baking

Whisked mixture

Cakes/Biscuits		 [°C]	 ⁵ ₁	 [min.]
Tart / flan base (2 eggs)		160–170 ²⁾	2	20–30
	 ¹⁾	160–170 ^{2) 3)}	2	15–25
Sponge cake (4 to 6 eggs)		170–180 ²⁾	2	20–35
	 ¹⁾	150–160 ^{2) 3)}	2	30–45
Whisked sponge cake *		180 ²⁾	2	25–35
	 ¹⁾	150–170 ^{2) 3)}	2	20–45
Swiss roll		170–180 ^{2) 3)}	2	13–25
	 ¹⁾	180–190 ^{2) 3)}	2	12–25













 Function /  Fan Plus /  Conventional Heat



 Temperature /  ⁵₁ Shelf level /  Duration



* The settings also apply for testing in accordance with EN 60350-1.

- 1) Switch the catalyser off before starting the programme. Select Settings – Catalyser – Off.
- 2) During the heating-up phase select Open further settings – Rapid Heat-up – Off.
- 3) Pre-heat the oven.

Choux pastry, puff pastry, meringue

Cakes/Biscuits		 [°C]	 ⁵ 1	 [min.]
Choux buns (1 tray)		160-170	2	30-45
		180-190 ^{2) 3) 4)}	3	25-35
Choux buns (2 trays)		160-170 ⁴⁾	1+3	30-45 ⁵⁾
Puff pastry (1 tray)		170-180	2	20-30
		190-200	3	20-30
Puff pastry (2 trays)		170-180	1+3	20-30 ⁵⁾
Macaroons (1 tray)		120-130	2	25-50
	 ¹⁾	120-130 ^{2) 3)}	3	25-45
Macaroons (2 trays)		120-130	1+3	25-50 ⁵⁾





 Function /  Fan Plus /  Conventional Heat

 Temperature / ⁵ Shelf level /  Duration

- 1) Switch the catalyser off before starting the programme. Select Settings – Catalyser – Off.
- 2) During the heating-up phase select Open further settings – Rapid Heat-up – Off.
- 3) Pre-heat the oven.
- 4) Select a function and set the temperature and then select Open further settings – Crisp function – On.
- 5) Take the baking trays out of the oven early if the food is sufficiently browned before the specified time has elapsed.

Roasting

Oven functions

Depending on how the food is being cooked, you can use Fan Plus , Moisture Plus , Auto Roast , Conventional Heat  or an Automatic programme.

Cooking container

You can use any heat-resistant dishes:

Miele Gourmet oven dishes, roasting pans, ovenproof glass trays, roasting bags, dishes made from earthenware or cast iron, the universal tray, rack and/or grilling and roasting insert (if available) on top of the universal tray.

We recommend roasting in covered oven dishes as this ensures that sufficient stock remains for making gravy.

The oven also stays cleaner than with open roasting.

Useful tips

- Browning: Browning only occurs towards the end of the roasting time. If cooking with a roasting dish, remove the lid about halfway through the roasting time if a more intensive browning result is desired.
- Standing time: At the end of the programme, take the roast out of the oven, wrap in aluminium foil and leave to stand for about 10 minutes. This helps retain juices when the meat is carved.
- Roasting poultry: For a crisp skin, baste the poultry 10 minutes before the end of the cooking time with slightly salted water.





Notes on using the roasting charts

In the charts the data for the recommended function is printed in bold.

Unless otherwise stated, the times given are for an oven which has not been pre-heated. With a pre-heated oven, shorten times by up to 10 minutes.

Temperature

As a general rule, select the lower temperature given in the chart. If higher temperatures are used, the meat will brown on the outside, but will not be properly cooked through.

When cooking with Fan Plus , Moisture Plus  or Auto Roast , select a temperature approx. 20 °C lower than for Conventional Heat .

For cuts which weigh more than 3 kg, select a temperature approx. 10 °C lower than that given in the roasting chart. Roasting will take longer at the lower temperature, but will be more even.

When roasting on the rack, set a temperature approx. 10 °C lower than if using an oven dish.

Pre-heating

Pre-heating is only required when roasting beef sirloin joints and fillets.

Roasting duration

The roasting time can be determined by multiplying the thickness of the roast [cm] with the time per cm [min./cm] stated below, depending on the type of meat:

- Beef/Venison: 15–18 min./cm
- Pork/Veal/Lamb: 12–15 min./cm
- Sirloin joints/Fillets: 8–10 min./cm

Roasting times are approx. 20 minutes longer per kilo for frozen meat. Frozen meat weighing less than approx. 1.5 kg does not need to be defrosted before roasting.

Check if the meat is cooked after the shortest time quoted.





















Shelf levels









As a general rule, use shelf level 2.



Roasting

Roasting charts

Beef, veal

Food		 [°C]	 ⁵ ₁	 [min.]	 ⁷⁾ [°C]
Topside of beef, approx. 1 kg	 / 	170–180	2	100–130 ⁵⁾	85–95
		190–200	2	110–140 ⁵⁾	
Fillet of beef, approx. 1 kg ¹⁾	 / 	150–160 ⁴⁾	2	20–50	40–70 ⁸⁾
	 ²⁾	150–160 ⁴⁾	2	20–50	
		180–190 ⁴⁾	2	20–50	
Sirloin joint, approx. 1 kg ¹⁾	 / 	150–160 ⁴⁾	2	30–60	40–70 ⁸⁾
	 ²⁾	150–160 ⁴⁾	2	30–60	
		180–190 ⁴⁾	2	30–60	
Veal, approx. 1.5 kg	 / 	190–200	2	70–90 ⁵⁾	70–80
	 ³⁾	190–200	2	70–90 ⁶⁾	
		200–210	2	70–90 ⁵⁾	

 Function /  Temperature /  ⁵₁ Shelf level /  Duration /  Core temperature
 Fan Plus /  Auto Roast /  Moisture Plus /  Conventional Heat

- 1) Use the universal tray. First sear the meat all over on the cooktop to seal it.
- 2) If using Moisture Plus  ²⁾, release a burst of steam at the beginning of the cooking programme.
- 3) If using Moisture Plus  ³⁾, once the heating-up phase has finished, manually release the bursts of steam at intervals throughout the programme.
- 4) Pre-heat the oven.
During the heating-up phase select Open further settings – Rapid Heat-up – Off.
- 5) Roast with the lid on first, then remove the lid halfway through roasting and add approx. 0.5 l liquid.
- 6) Add approx. 0.5 l liquid halfway through roasting.
- 7) When using the food probe, enter an appropriate core temperature for the food being cooked.
- 8) Depending on required degree of doneness: rare: 55–60 °C, medium: 65–70 °C, well-done: 70–75 °C

Pork

Food		[°C]	5 1	[min.]	³⁾ [°C]
Pork roast/neck, approx. 1 kg	/	160–170	2	100–120 ²⁾	80–90
	¹⁾	160–170	2	100–120 ²⁾	
		180–190	2	100–130 ²⁾	
Pork joint with crackling, approx. 2 kg	/	170–180	2	120–160 ²⁾	80–90
	¹⁾	180–190	2	120–160 ²⁾	
		190–200	2	130–160 ²⁾	
Gammon joint, approx. 1 kg	/	150–160	2	60–80 ²⁾	75–80
	¹⁾	150–160	2	60–80	
		170–180	2	80–100 ²⁾	
Meat loaf, approx. 1 kg	/	170–180	2	60–70 ²⁾	80–85
		200–210	2	70–80 ²⁾	

Function / Temperature / Shelf level / Duration / Core temperature

Fan Plus / Auto Roast / Moisture Plus / Conventional Heat

- 1) If using Moisture Plus ¹⁾, once the heating-up phase has finished, manually release the bursts of steam at intervals throughout the programme.
- 2) Add approx. 0.5 l liquid halfway through roasting.
- 3) When using the food probe, enter an appropriate core temperature for the food being cooked.

Roasting

Lamb, game

Food		[°C]	5 1	[min.]	5) [°C]
Leg of lamb, approx. 1.5 kg	/	170–180	2	90–110 ³⁾	75–80
	¹⁾	170–180	2	90–110 ⁴⁾	
		180–190	2	90–110 ³⁾	
Saddle of lamb, approx. 1.5 kg	/	220–230 ²⁾	2	40–60 ⁴⁾	70–75
	¹⁾	220–230 ²⁾	2	40–60	
		230–240 ²⁾	3	40–60 ⁴⁾	
Venison, approx. 1 kg	/	200–210	2	80–100 ³⁾	80–90
		200–210	2	80–100 ³⁾	

Function / Temperature / Shelf level / Duration / Core temperature

Fan Plus / Auto Roast / Moisture Plus / Conventional Heat

- 1) If using Moisture Plus , once the heating-up phase has finished, manually release the bursts of steam at intervals throughout the programme.
- 2) Pre-heat the oven.
- 3) Roast with the lid on first, then remove the lid halfway through roasting and add approx. 0.5 l liquid.
- 4) Add approx. 0.5 l liquid halfway through roasting.
- 5) When using the food probe, enter an appropriate core temperature for the food being cooked.

Poultry, fish

Food		[°C]	5 1	[min.]	³⁾ [°C]
Poultry, 0.8–1 kg	/	180–190	2	60–70	85–90
		190–200	2	60–70	
Poultry, approx. 2 kg	/	180–190	2	100–120	85–95
		190–200	3	100–120	
Poultry, stuffed, approx. 2 kg	/	180–190	2	110–130	85–95
		190–200	3	110–130	
Poultry, approx. 4 kg	/	160–170	2	120–160 ²⁾	85–90
		180–190	2	120–160 ²⁾	
Fish, whole, approx. 1.5 kg	/	160–170	2	45–55	75–80
	¹⁾	160–170	2	45–55	
		180–190	2	45–55	

Function / Temperature / ⁵/₁ Shelf level / Duration / Core temperature
 Fan Plus / Auto Roast / Moisture Plus / Conventional Heat

- 1) If using Moisture Plus ¹⁾, once the heating-up phase has finished, manually release the bursts of steam at intervals throughout the programme.
- 2) Add approx. 0.5 l liquid halfway through roasting.
- 3) When using the food probe, enter an appropriate core temperature for the food being cooked.

Roasting

Food probe

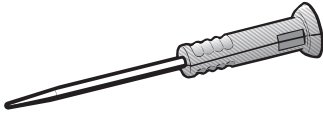

The wireless food probe enables the roasting process to be monitored simply and reliably.

How it works

The metal tip of the food probe is inserted into the food. There is a temperature sensor in the metal tip which measures the core temperature of the food during cooking.

The temperature sensor is located approx. 2 cm from the tip. Insert the food probe so that the temperature sensor is positioned centrally (see "Important notes about using the food probe").

The rise in the core temperature reflects the extent to which the food is cooked. You can programme the core temperature to be lower or higher, depending on whether you want your meat to be rare, medium or well-done.

A core temperature of up to 99 °C can be set. Please refer to the roasting chart and "Low temperature cooking" for the core temperatures applicable for different types of meat.

The cooking time will be similar when cooking with or without the wireless roast probe.

The core temperature value is sent via radio signal from the transmitter in the handle of the food probe via the antenna in the back wall of the oven to the appliance's electronic unit as soon as the food with the food probe is placed in the oven.





Uninterrupted transmission of the signal is only possible with the door shut. If the oven door is opened during the cooking programme, e.g. to baste the meat, then the signal is interrupted. It will resume once the door has been closed. It will take a few seconds for the current core temperature to appear in the display again.

The temperature sensor will be destroyed at temperatures above 100 °C. As long as it remains inserted in the food, there is no risk of damage, since the maximum core temperature setting is 99 °C. If you are not using the wireless roast probe, do not keep it in the oven during cooking. Always put it back into the storage sleeve in the door.

When the food probe can be used

Some Automatic programmes and Special applications will prompt you to use the food probe.

You can also use it with your own User programmes and with the following functions:

- Auto Roast 
- Fan Plus 
- Intensive Bake 
- Conventional Heat 
- Moisture Plus 
- Fan Grill 

Important notes about using the food probe

To ensure the probe works correctly, please observe the following instructions.

- Do not use deep, narrow, metal cooking containers, as these will weaken the radio signal.
- Do not place any metal items above the food probe, such as lids, aluminium foil, racks or universal trays on a shelf level above the food with the food probe. Glass lids may be used.
- Do not use another standard metal cooking thermometer at the same time.
- Do not allow the handle of the food probe to sit in any sauce or cooking liquid, or to rest on the food or on the edge of the cooking container.

Danger of breaking!

Do not use the wireless food probe to lift or carry the food.

Roasting

In addition please note:

- You can place the meat in a pot or on the rack in the universal tray.
- The metal tip of the food probe must be fully inserted into the centre of the food. The handle should be angled upwards and not horizontal towards the corners or the door of the oven.
- When cooking poultry, insert the metal tip into the thickest part of the breast. You can find the thickest part of the breast by pressing the area with your thumb and index finger.
- Do not let the metal tip touch any bones or insert it into a particularly fatty area of the meat. If fat or bone come into contact with the probe, this can lead to the oven being switched off too early.
- If the meat is very heavily marbled with fat, select the highest core temperature given in the roasting chart.
- When using roasting bags or aluminium foil, insert the probe through the bag or foil into the centre of the meat. You can also place the meat, with the food probe inserted, inside the foil. Follow the roasting bag / aluminium foil manufacturer's instructions.
- The food probe can only be inserted horizontally into flat food, e.g. fish. Therefore place flat food in glass or ceramic cooking containers, as the walls of a metal container would disturb the radio signals.

If the food probe is no longer recognised during cooking, a message will appear in the display. Change the position of the food probe in the food.

Using the food probe

- Remove the food probe from its holder in the door.
- Insert the metal tip of the food probe fully into the food. Make sure that the handle is angled upwards.
- Place the food in the oven.
- Close the door.
- Select the oven function or Automatic programme.

The message *Continue cooking with the food probe?* will appear.

- Select *Yes*.
- Change the recommended temperature if necessary.
- Change the recommended core temperature if necessary.

The core temperatures cannot be changed for the Automatic programmes.

You can also start the process at a later time. Select *Open further settings* and set a time in the *Start at* field. With Automatic programmes, select *Start later*.

You can estimate approximately when the food will be ready as the duration of the cooking programme is about the same as if you were cooking food without using the food probe.

You cannot enter a *Duration* or *Finish at* time, as the total cooking duration is determined by how long it takes for the core temperature to be reached.

Roasting

Time remaining display

If the temperature set for a cooking process is above 140 °C, the estimated time left for the cooking process will appear in the display after a short while.

The time remaining is calculated from the cooking temperature selected, the required core temperature and the pattern of the increasing core temperature.

The time remaining first shown is an estimate. As the cooking process continues, the time remaining is revised continuously, and a more accurate revised figure shown.

Altering the cooking or core temperature or selecting a different function will delete the time left information. The time remaining will be recalculated if the door is kept open for a long period of time.

Displaying the core temperature

As soon as the time remaining appears, you can also display the actual core temperature.

- Select *Change*.
- Select *Display core temperature*.
- Select *On*.
- Confirm with *OK*.

The actual core temperature will also appear in the display.

Using residual heat

The heating in the oven switches off shortly before the end of the cooking programme. The residual heat in the oven is sufficient to complete the cooking process.

Using the residual heat in the oven saves energy.

Energy save phase will appear in the display to show that the oven is in energy save mode. The measured core temperature is no longer visible.

The cooling fan continues to run, as does the hot air fan if a "fan" setting has been chosen.

When the core temperature selected has been reached,

- *Process finished* appears in the display.
- a buzzer will sound if the buzzer is switched on (see "*Settings - Volume - Buzzer tones*").

Useful tip: If the food is not yet cooked sufficiently, insert the food probe into another place and repeat the programme.

Low temperature cooking

This type of cooking is ideal for cooking beef, pork, veal or lamb when a tender result is required.

First briefly sear the meat all over at a high temperature on the cooktop in order to seal it.

Then place the meat in the pre-heated oven where the low temperature and long cooking duration will cook it to perfection and ensure it is very tender.



The meat will relax and the juices inside will start to circulate evenly throughout the meat to reach the outer layers. This will give very tender and succulent results.

Useful tips

- Use lean meat which has been correctly hung and trimmed. Bones should be removed before cooking.
- For searing, use a suitable cooking oil or fat that can withstand high temperatures (e.g. clarified butter).
- Do not cover meat during cooking.

The cooking duration is approx. 2–4 hours and depends on the weight and size of the meat, as well as the desired degree of doneness and browning.

Cooking duration/Core temperatures

Meat	 [min.]	 [°C]
Fillet of beef	105–120	60–75
Sirloin joint		
– Rare	60–90	55–60
– Medium	120–150	65–70
– Well-done	180–240	70–75
Pork fillet	120–150	65–80
Gammon*	150–210	75–80
Veal fillet	80–100	60–75
Saddle of veal*	180–210	65–75
Saddle of lamb*	90–120	65–75

 Duration

 Core temperature

* Boned

After cooking

- Meat can be carved straight from the oven. It does not need to rest.
- The cooking result will not be affected if the meat is left in the oven after the programme has finished. It can be kept warm until you serve it.
- The meat is an ideal temperature to eat straight away. Serve on pre-heated plates with very hot sauce or gravy to prevent it cooling down too quickly.

Low temperature cooking

Using the "Low temperature cooking" special application

Please also refer to the information in "Roasting - Food probe".

- Select Special applications .
- Select Low temp. cooking.
- Set the required temperature.
- Set the core temperature.
- Follow the instructions in the display. Pre-heat the rack and the universal tray in the oven.
- While the oven is pre-heating, sear the meat on all sides on the cooktop.

Danger of burning!

Wear oven gloves when placing food in the oven or removing it and when adjusting oven shelves etc. in a hot oven.

- As soon as Use the food probe appears in the display, place the seared meat on the rack and insert the metal tip of the food probe fully into the centre of the meat.

 **Danger of burning!**
The top heating element / grill element in the oven will be hot.

- Close the door.

At the end of the programme, Process finished will appear in the display and a buzzer will sound if the buzzer is switched on (see "Settings – Volume – Buzzer tones").

If the meat is not cooked to your satisfaction, you can cook it for longer.

Low temperature cooking - setting the temperature manually

Use the universal tray with the rack placed on top of it.
Do not use the Rapid Heat-up function to pre-heat the oven.

- Place the rack together with the universal tray on shelf level 2.
- Select Oven functions .
- Select Conventional Heat and a temperature of 130 °C.
- Switch off Rapid Heat-up by selecting Change – Open further settings – Rapid Heat-up – Off.
- Pre-heat the oven together with the universal tray and rack for approx. 15 minutes.
- While the oven is pre-heating, sear the meat on all sides on the cooktop.



Danger of burning!

Wear oven gloves when placing food in the oven or removing it and when adjusting oven shelves etc. in a hot oven.

- Place the seared meat on the rack.
- Select Change.
- Reduce the temperature to 100 °C.
- Continue cooking until the end of the cooking duration.

You can set the cooking programme to switch off automatically (see "Additional functions - Setting the duration").

Grilling



Danger of burning!

Grill with the oven door closed. If you grill with the door open, hot air will escape from the oven instead of being cooled by the cooling fan. The controls will get hot.

Oven functions

Full Grill

For grilling and toasting bread, open sandwiches etc. and browning baked dishes.

The whole of the top heat/grill element will get hot and glow red.

Economy Grill

For grilling thin cuts in small quantities and for browning small baked dishes.

The centre of the grill element glows red to generate the required heat.

Fan Grill

For grilling thicker items, e.g. rolled meat, poultry pieces.

The top heat/grill element and fan are switched on alternately.

Cooking container

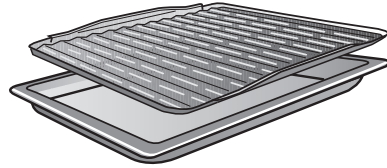

Use the universal tray with the rack or grilling and roasting insert (if available) on top. The juices from the food being cooked collect under the insert. This prevents them from spitting and making the oven dirty. The juices can be used for making gravy and sauces.

Do not use the baking tray.

Preparing food for grilling

Rinse meat under cold running water and then pat dry. Do not season meat with salt before grilling as this draws the juices out.

Add a little oil to lean meat if necessary. Do not use other types of fat as they can burn and cause smoke.

Clean fish in the normal way. To enhance the flavour, add a little salt or squeeze a little lemon juice over the fish.

Grilling

- Place the rack or the roasting and grilling insert (if available) in the universal tray.
- Place the food on top.
- Select the required oven function and the temperature.
- Pre-heat the top heat/grill element for approx. 5 minutes with the door closed.



Danger of burning!

Wear oven gloves when placing food in the oven or removing it and when adjusting oven shelves etc. in a hot oven.

- Place the food on the appropriate shelf level (see Fan Grilling guide).
- Close the door.
- Turn the food halfway through grilling.

Grilling

Notes on the grilling chart

Check the food after the shortest time quoted.

Take note of the temperature range, the shelf levels and the durations. These take the size of the meat and cooking practices into account.

Temperature

As a general rule, select the lower temperature given in the chart. If higher temperatures are used, the meat will brown on the outside, but will not be properly cooked through.

Pre-heating

Always pre-heat the top heat/grill element for approx. 5 minutes with the door closed.

Shelf levels

Select the shelf level according to the thickness of the food.

- Thin cuts: shelf level 3 or 4
- Thick cuts: shelf level 1 or 2

Grilling duration

- Flat pieces of fish and meat usually take 6–8 minutes per side. Thicker pieces require more time for each side. It is best to grill food of a similar thickness at the same time so that the grilling time for each item does not vary too greatly.
- Turn the food halfway through grilling.

Testing to see if cooked





One way of finding out how far through a piece of meat has been cooked is to press down on it with a spoon:

- | | |
|------------|--|
| Rare: | If there is very little resistance to the pressure of the spoon, it will still be red on the inside. |
| Medium: | If there is some resistance, the inside will be pink |
| Well-done: | If there is great resistance, it is cooked through. |

Check if the meat is cooked after the shortest time quoted.



Useful tip: If the surface of thicker cuts of meat is cooked but the centre is still raw, continue grilling at a lower temperature setting or use a lower shelf level to allow the food to cook through to the centre.

Fan Grill

- Use the Fan Grill  function for meat, fish, poultry and vegetables.
- Always pre-heat for at least 5 minutes before Fan Grilling.
- It is not necessary to turn food when Fan Grilling . Only one side of the food, however, will become brown.
- The door must be closed when using Fan Grill .
- When using red meat, pat the meat dry before Fan Grilling as this encourages a richer colour.
- **Ovens with the Crisp function:** Activate the Crisp function (moisture reduction) at the beginning of the Fan Grill  function. This is great for items that are moist on the inside and should be crispy on the outside.

All temperatures are approximations and must be varied according to the thickness and preparation of the meat. The chart below is a suggested guide only. Personal taste and size of serves will vary times and temperatures. We recommend you monitor cooking results for best outcomes.

Grilling

Food to be grilled	 [°C]	 5 1	 [min.]
Lean thin sausages	180	4	8–10
Thick sausages	180	4	15–20
Lean beef fillet steak	220	5	6–12
Chicken breast fillet	200	4	14–18
Whole butterflied chicken	200	3	30–35
Thin white fish fillets	220	5	6–10
Thick fish fillets, cutlets or steaks	200	4	10–15
Oily fish	200	4	8–12
Lamb loin chops	190	4	12–16
Lamb back straps	220	5	8–10
Vegetables, capsicum, zucchini, sweet potato, eggplant	200	5	12–15
Potato wedges or small roast potatoes	220	3	20–25
Kebabs and satays (red meat)	200	5	12–15
Chicken satays	200	4	12–15

 Shelf level /  5
1 Temperature /  Duration

Fan Grill  can be used for small roasts but is only recommended for lean, tender cuts of meat, e.g. lamb racks, rump roasts, and beef fillet. Fan Grill the roast at 200 °C on shelf level 3 for approximately 25 minutes, depending on thickness.

Grill

- Use Grill  for thick toasts, muffins, cheese on toast, focaccia, bruschetta and bacon.
- Pre-heat the grill for at least 5 minutes at 200–220 °C.
- Select the appropriate shelf level for the thickness of the food.
- The door must be closed when using the Grill function.

This is a suggested guide only. Personal taste and size of serves will vary times and temperatures.

Special applications

Your oven has the following Special applications in addition to the Automatic programmes:

■ Select Special applications .

The following Special applications are available:

- Defrost
- Drying
- Reheat
(Reheating plated meals)
- Heat crockery
- Prove yeast dough
- Low temp. cooking

This Special application is described in "Low temperature cooking".

- Pizza

This section also gives information on the following applications:

- Gentle Bake
- Bottling
- Frozen food/Ready meals

Defrost

Use the Defrost function to gently defrost frozen food.

The temperature can be set between 25 and 50 °C.

- Select Special applications .
- Select Defrost.
- Alter the recommended temperature, if necessary, and then set the duration.
- Follow the instructions in the display.

Air is circulated throughout the cabinet to gently defrost the food.



Danger of salmonella poisoning!
It is particularly important to observe food hygiene rules when defrosting poultry.

Do not use the liquid from the defrosted poultry. Pour it away, and wash the tray, the sink and your hands.

Useful tips

- Where possible, remove the packaging and put the food to be defrosted on the universal tray or into a suitable dish.
- When defrosting poultry, put it on the rack over the universal tray to catch the defrosted liquid so that the meat is not lying in this liquid.
- Meat and poultry need to be fully defrosted before cooking. Fish, on the other hand, can be partially defrosted before cooking. Defrost so that the surface is sufficiently soft to take herbs and seasoning.

Defrosting times

The time needed for defrosting depends on the type and weight of the food, and at what temperature it was deep frozen. The following chart is for guidance only. It is important to check that food is thoroughly defrosted.

Frozen food	 [g]	 [min.]
Chicken	800	90–120
Meat	500	60–90
	1000	90–120
Sausages	500	30–50
Fish	1000	60–90
Strawberries	300	30–40
Yeast butter cake	500	20–30
Bread	500	30–50

 weight /  defrosting duration

Special applications

Drying

This programme is designed for traditional style drying of food to preserve it.

The temperature can be set between 80 and 100 °C.

It is important that fruit and vegetables are ripe and not bruised before they are dried.

- Prepare the food for drying.
 - Peel and core apples, and cut into slices 0.5 cm thick.
 - Stone plums, if necessary.
 - Peel, core and cut pears into wedges.
 - Peel and slice bananas.
 - Clean mushrooms, then either halve or slice them.
 - Remove parsley and dill from the stem.
- Distribute the food evenly over the universal tray.

You can also use the Gourmet perforated baking tray (if available).

- Select Special applications .
- Select Drying.
- Alter the recommended temperature, if necessary, and then set the duration.
- Follow the instructions in the display.

Food	 [min.]
Fruit	120–480
Vegetables	180–480
Herbs*	50–60

 Drying time

- * Because this programme uses the fan, you should use Conventional Heat with a temperature of 80–100 °C for drying herbs.
- Reduce the temperature if condensation begins to form in the oven.

 **Danger of burning!**
Wear oven gloves when removing the dried food from the oven.

- Allow the dried fruit or vegetables to cool down after drying.

Dried fruit must be completely dry, but also soft and elastic. Juice must not escape when cut.

- Store in sealed glass jars or tins.

Reheat

This programme uses moisture and is designed for reheating plated meals.

You can select:

- Meat cuts with vegetables
- Meat cuts with potatoes
- Meat cuts with dumplings
- Meat cuts with pasta
- Fish with vegetables
- Fish with potatoes
- Vegetable bake
- Pasta bake
- Pasta with sauce
- Pizza
- Casserole

Use heat-resistant crockery.

- Place the food to be reheated in its dish on the rack. Do not cover it.
- Select Special applications .
- Select Reheat.
- Select the plated meal and set the heating level.
- Follow the instructions in the display.



Danger of burning!

Wear oven gloves when removing the dishes from the oven. Droplets of water may have accumulated underneath the dish.

Heat crockery

This programme is designed to pre-heat your crockery.

The temperature can be set between 50 and 80 °C.

Use heat-resistant crockery.

- Place the rack on shelf level 2 and place the crockery to be pre-heated on it. Depending on the size of the crockery, you can also place it on the oven floor and additionally take the shelf runners out to make more room.
- Select Special applications .
- Select Heat crockery.
- Alter the recommended temperature, if necessary, and then set the duration.
- Follow the instructions in the display.



Danger of burning!

Wear oven gloves when removing the dishes from the oven. Droplets of water may have accumulated underneath the dish.

Special applications

Prove yeast dough

This programme is designed specifically for proving yeast dough without the addition of moisture.

The temperature can be set between 30 and 50 °C.

- Select Special applications .
- Select Prove yeast dough.
- Alter the recommended temperature, if necessary, and then set the duration.
- Follow the instructions in the display.

If you wish to prove dough with the addition of moisture, select the relevant Automatic programme.

Pizza

This programme is designed specifically for baking pizza.

The temperature can be set between 160 and 250 °C.

- Select Special applications .
- Select Pizza.
- Alter the recommended temperature, if necessary, and then set the duration.
- Follow the instructions in the display.

Gentle Bake

Gentle Bake is suitable for small amounts e.g. of frozen pizza, bake-off rolls, cookies and for meat dishes and roasts. The optimum use of residual heat enables savings of up to 30% energy to be made compared to cooking with a standard oven function with comparably good cooking results.

The temperature can be set between 100 and 250 °C.

- Select Oven functions .
- Select Gentle Bake and alter the recommended temperature if necessary.
- Follow the instructions in the display.

For optimum results, keep the door closed whilst cooking.

Examples of use

Food	🌡️ [°C]	🕒 [min.]
Biscuits	150	25–30
Ratatouille	180	40–60
Fish fillet in foil approx. 500 g	200	25–30
Frozen pizza, pre-cooked	200	20–25
Ham roast, approx. 1.5 kg	160	130–160
Braised beef, approx. 1.5 kg	180	160–180

🌡️ Temperature / 🕒 Duration

- Use shelf level 1 or 2 depending on the height of the food.
- The durations given are for an oven which has not been pre-heated.
- Roast with the lid on first, then remove the lid three-quarters of the way through roasting and add approx. 0.5 l liquid.
- Check the food after the shortest duration quoted.

Special applications

Bottling

Containers for bottling

 **Danger of injury!**
Do not use the appliance to heat up or bottle food in sealed tins. Pressure will build up inside them and they can explode causing damage to the appliance, as well as the risk of injury and scalding.

Only use special jars for bottling:

- bottling jars
- jars with twist-off lids

Bottling fruit and vegetables

We recommend using Fan Plus .

The instructions are for 6 jars with a capacity of 1 litre each.

- Place the universal tray on shelf level 2 and place the jars on the tray.
- Select Fan Plus  and a temperature of 150–170 °C.
- Wait until bubbles evenly rise in the jars.

Reduce the temperature at the right time to avoid the produce boiling over.

Fruit/Cucumbers

- Select the lowest temperature as soon as bubbles are visible in the jars. Then leave the jars in the warm oven for a further 25–30 minutes.

Vegetables

- Reduce the temperature to 100 °C as soon as bubbles are visible in the jars.

	 [min.]
Carrots	50–70
Asparagus, peas, beans	90–120

 Bottling duration

- After the bottling duration has finished, select the lowest temperature and leave the jars in the oven for a further 25–30 minutes.

After bottling

 **Danger of burning!**
Wear oven gloves when removing the jars from the oven.

- Take the jars out of the oven.
- Cover the jars with a towel and leave to set for approx. 24 hours.
- Make sure all jars are closed properly when storing them.

Frozen food/Ready meals

Useful tips

Cakes, pizza, baguettes

- Large frozen items such as cakes, pizzas or baguettes cover an extensive area of the baking tray or universal tray.
The temperature difference if large frozen items are cooked in these trays can cause the tray to distort in such a way that it cannot be removed from the oven when it is hot. Further use will make the distortion worse. Place this type of food on baking paper on the rack to prevent the risk of this happening.
- Use the lowest temperature recommended on the manufacturer's packaging.

Oven chips, croquettes or similar items

- Small items of frozen food such as oven chips can be cooked on the baking tray or universal tray.
Place baking paper on the tray so that they cook gently.
- Use the lowest temperature recommended on the manufacturer's packaging.
- Turn several times during cooking.

Preparation

Eating food which has been cooked correctly is important for preventing food poisoning or other ailments. Only bake cakes, pizza, chips etc. until they are golden brown. Do not overcook them.

- Select the function and temperature recommended on the manufacturer's packaging.
- Pre-heat the oven.
- Place the food in the oven on the shelf level recommended on the packaging when the temperature indicator light goes out.
- Check the food at the end of the shortest time recommended on the packaging.

Useful tip: This oven offers Automatic programmes for some Frozen food/Ready meals (see "Automatic programmes").

Cleaning and care



Danger of burning!

Make sure the oven heating elements are switched off and that the oven cavity is cool.



Danger of injury!

The steam from a steam cleaning appliance could reach electrical components and cause a short circuit.

Do not use a steam cleaner to clean the oven.

All surfaces can become discoloured or damaged if unsuitable cleaning agents are used. The front of the oven, in particular, will be damaged by oven cleaners and descaling agents.

All surfaces are susceptible to scratching. Scratches on glass surfaces may cause a breakage.

Remove any cleaning agent residues immediately.

Unsuitable cleaning agents

To avoid damaging the surfaces of your appliance, do not use:

- cleaning agents containing soda, ammonia, acids or chlorides,
- cleaning agents containing descaling agents on the oven front,
- abrasive cleaning agents, e.g. powder cleaners and cream cleaners,
- solvent-based cleaning agents,
- stainless steel cleaning agents,
- dishwasher cleaner,
- glass cleaning agents,
- cleaning agents for ceramic cooktops,
- hard, abrasive brushes or sponges, e.g. pot scourers, brushes or sponges which have been previously used with abrasive cleaning agents,
- dirt erasers,
- sharp metal tools,
- steel wool or metal scourers,
- selective cleaning with mechanical cleaning agents,
- oven cleaner, *
- stainless steel spiral pads. *

* These can, however, be used to remove very heavy soiling from PerfectClean treated surfaces.

If soiling is left for a long time, it might become impossible to remove. Continued use without regular cleaning will make the oven much harder to clean.

Failure to maintain the oven in a clean condition could lead to deterioration of the surfaces that could adversely affect the life of the appliance and result in a hazardous situation.

Remove any soiling immediately.

The accessories are not dishwasher-safe, with the exception of the wireless food probe.

Useful tips

- Soiling caused by spilt juices and cake mixtures is best removed whilst the oven is still warm. Exercise caution and make sure the oven is not too hot - danger of burning.
- To make cleaning by hand easier, you can dismantle the oven door, remove the shelf runners and the FlexiClip telescopic runners (if present), and lower the top heat/grill element.

Normal soiling

The fibreglass seal around the front of the oven should be handled carefully. Do not rub and scour it. If possible, you should avoid trying to clean it.

- It is best to remove normal soiling immediately using a clean sponge and a solution of hot water and washing-up liquid or with a clean, damp microfibre cloth.
- After cleaning, make sure all residual cleaning agents are thoroughly removed with clean water. This is particularly important when cleaning surfaces treated with PerfectClean enamel as cleaning agent residues can impair the non-stick properties.
- After cleaning, wipe the surfaces dry using a soft cloth.

Food probe

The food probe can be cleaned in the dishwasher.

Cleaning and care

Stubborn soiling (excluding the FlexiClip telescopic runners)

Spilt fruit and roasting juices may cause lasting discolouration or matt patches on enamelled surfaces. This discolouration is permanent but will not affect the efficiency of the finish. Do not use force to remove this discolouration! Clean these following the instructions given here.

- Baked-on residues can be removed with a glass scraper or a non-abrasive stainless steel pad.
- Stubborn soiling on PerfectClean surfaces can be cleaned using Miele oven cleaner. This cleaner must only be applied to cold surfaces in accordance with the instructions on the packaging.

Non-Miele oven spray must only be used in a cold oven and for no longer than a maximum of 10 minutes.

- If necessary, the scouring pad on the back of a non-scratching washing-up sponge can be used to remove the soiling.
- After cleaning, remove all oven cleaning agent residues thoroughly with clean water, and dry with a soft cloth.

Pyrolytic cleaning of the oven interior

Instead of cleaning the oven by hand, you can run the Pyrolytic cleaning programme .

During the Pyrolytic cleaning programme the oven interior is heated up to over 400 °C. Any residual soiling is broken down and reduced to ash by the high temperatures.

This oven has three levels of pyrolytic cleaning, each with a different duration. Select:

- Level 1 for light soiling
- Level 2 for heavier soiling
- Level 3 for very heavy soiling

The oven door locks automatically as soon as the Pyrolytic cleaning programme starts. It cannot be opened until after the programme has finished.

The timer can be used to delay the start time of the Pyrolytic cleaning programme, for instance to make use of cheaper electricity tariffs.

At the end of the Pyrolytic cleaning programme any residues such as ash from the pyrolytic process can be easily wiped away.

Setting up for the Pyrolytic cleaning programme

The high temperatures used during pyrolytic cleaning will damage accessories that are not designed for cleaning in the Pyrolytic cleaning programme.

Please remove these accessories from the oven interior before starting the Pyrolytic cleaning programme.

This also applies to non-pyrolytic accessories purchased separately to the oven.

The following accessories are suitable for cleaning in the Pyrolytic cleaning programme and can be left in the oven:

- Shelf runners
- FlexiClip telescopic runners HFC 72
- Rack HBBR 72
- Take all non-pyrolytic accessories out of the oven.
- Place the rack on the top shelf level.

Coarse soiling in the oven compartment can cause an accumulation of smoke which can lead to the Pyrolytic cleaning programme switching off. Burnt on residues can leave discolouration or matt areas on enamelled surfaces.

- Before running the Pyrolytic cleaning programme, remove coarse soiling from the oven compartment and loosen any burnt on residues with a scraper suitable for use on glass.

Cleaning and care

Starting the Pyrolytic cleaning programme



Danger of burning!

The oven door gets much hotter during the Pyrolytic cleaning programme than during normal use. Prevent children from touching the oven during the Pyrolytic cleaning programme.

- Select Maintenance
- Select Pyrolytic.
- Select the level required according to the level of soiling.
- Confirm with *OK*.

Follow the instructions in the display.

- Confirm with *OK*.

Starting the Pyrolytic cleaning programme

- To start the Pyrolytic cleaning programme immediately, select *Start now*.
- Confirm with *OK*.

The Pyrolytic cleaning programme will now start.

The door locks automatically. The oven heating and the cooling fan will then switch on automatically.

The oven lighting will not come on during the Pyrolytic cleaning programme.

The time remaining for the Pyrolytic cleaning programme will appear in the display. You cannot alter the duration.

If you have set a minute minder at the same time as running the Pyrolytic cleaning programme, the buzzer will sound and the symbol will start flashing at the end of the minute minder time. The time will then continue to increase in the display.

The buzzer will stop and the visual indicators will go out as soon as you touch .

Delaying the start time of the Pyrolytic cleaning programme

- To delay the start of the Pyrolytic cleaning programme, select *Start later*.
- Confirm with *OK*.
- Set the time at which you want it to start.
- Confirm with *OK*.

The door will lock automatically. *Start at* and the set start time appear in the display.

Using *Change*, you can alter the start and end time at any point up until the start of the programme.

As soon as the start time is reached, the oven heating and the cooling fan will switch on automatically. The duration remaining will appear in the display.

At the end of the Pyrolytic cleaning programme

When the duration remaining reaches 00:00 h, a message will appear in the display to tell you that the door is unlocking.

When the door lock has been released,

- Process finished appears in the display:
- a buzzer will sound if the buzzer is switched on (see "Settings - Volume - Buzzer tones").

- Switch the oven off.

The visual and acoustic signals are switched off.



Danger of burning!

Wait until the oven has cooled down before removing residual soiling left in the oven compartment from pyrolytic cleaning.

- Wipe any residues (e.g. ash) left behind after the Pyrolytic cleaning programme out of the oven compartment and wipe any residues off any pyrolytic accessories. The amount of ash will vary depending on how dirty the oven was.

Most soiling can be easily removed using a clean, damp microfibre cloth, or with warm water and a little washing-up liquid on a clean sponge.

Depending on how dirty the oven was before cleaning, there may be a visible layer of soiling across the inner glass pane on the door. This should be removed using the reverse of a non-scouring washing-up sponge, a glass scraper or with a stainless steel spiral pad and a little washing-up liquid.

- Extend and retract the FlexiClip telescopic runners several times after running the Pyrolytic cleaning programme.

Please note:

- The fibreglass seal around the front of the oven should be handled carefully. Do not rub and scour it. If possible, you should avoid trying to clean it.
- The FlexiClip telescopic runners may appear discoloured or a lighter colour in places after they have been cleaned. This will not affect the functioning of the runners in any way.
- Spilt fruit juices may cause lasting discolouration to enamelled surfaces. This discolouration is permanent but will not affect the efficiency of the enamel. Do not attempt to remove these marks.

Cleaning and care

The Pyrolytic cleaning programme is cancelled

If the Pyrolytic cleaning programme is cancelled, the oven door will remain locked until the temperature inside the oven drops to below 280 °C.

The following will cause the Pyrolytic cleaning programme to stop:

- Switching the oven off.
- A power cut.

If you turn the oven off, Switch appliance off? will appear in the display.

- Select "Yes if you want to cancel the Pyrolytic cleaning programme.

The door will unlock once the temperature in the oven has dropped below 280 °C and the oven is switched off.

- Select No if you want to continue running the Pyrolytic cleaning programme.

The Pyrolytic cleaning programme will continue running.

If there has been a power cut, Process cancelled. Cooling down will appear in the display once power is restored.

The door will unlock once the temperature in the oven has dropped below 280 °C and the oven is switched off.

A buzzer will sound if the buzzer is switched on (see "Settings - Volume - Buzzer tones").

Process finished appears in the display.

- Select ←↵.
- Start the Pyrolytic cleaning programme again.

Removing the door

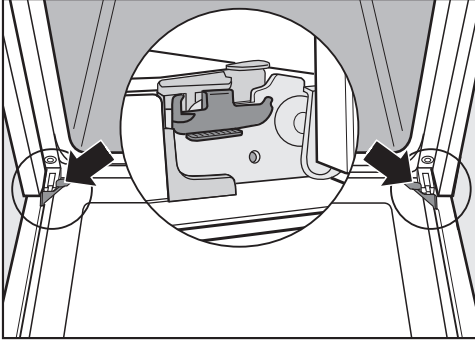

The door is connected to each door hinge by retainers. Before the door can be removed the locking clamps on both hinges must first be unlocked.

- Open the door fully.

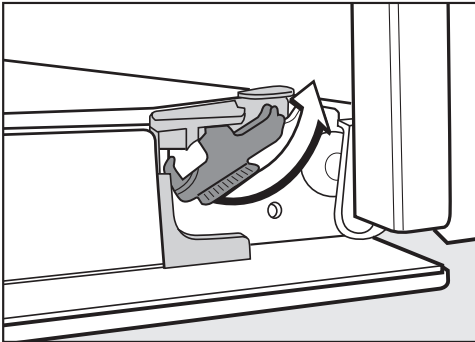

- Release the locking clamps by turning them as far as they will go.

Do not pull the door horizontally off its retainers, as they will spring back against the oven.

- Raise the door up till it rests open.

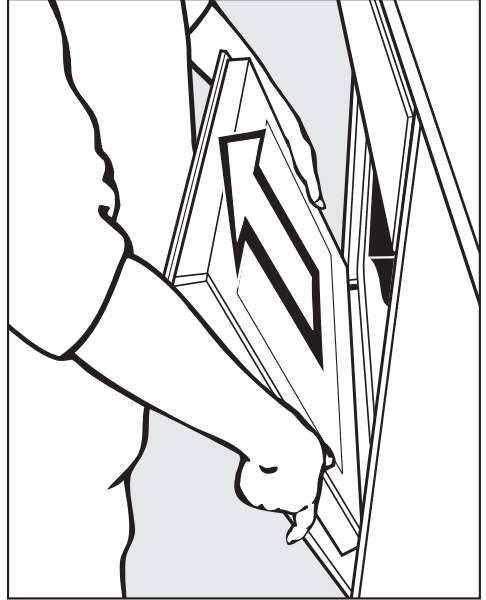

- Hold the door securely at both sides, and lift it upwards off the retainers. Make sure you take it off straight.

Cleaning and care

Dismantling the door

The oven door is an open system with 4 glass panes which have a heat-reflective coating on some of their surface.

When the oven is operating, air is directed through the door to keep the outer pane cool.

If soiling has worked its way in between the glass panes, the door can be dismantled in order to clean in between the panes.

Take particular care as scratches can damage the glass. When cleaning the glass panes, do not use abrasive cleaning agents, hard sponges or brushes, and do not use sharp metal tools or scrapers.

Please also read the general notes on cleaning the oven front before cleaning the glass panes.

The glass panes are coated in different ways with a heat-reflective coating on the sides facing into the oven cavity. The glass panes must be fitted the right way round after being cleaned.

Oven spray will damage the aluminium trims inside the door. These should only be cleaned using hot water and washing-up liquid applied with a clean sponge or a clean, damp microfibre cloth.

Be especially vigilant after dismantling the door that the glass panes do not break.

Cleaning and care

 **Danger of injury!**
Always remove the door before disassembling it.

- Place the door with the outer glass pane on a soft surface (e.g. a tea towel) to prevent it getting scratched.

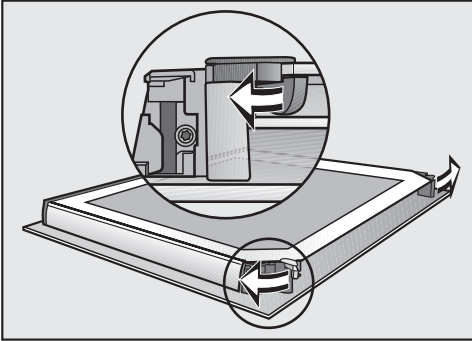

- Flip the two glass pane retainers outwards to open them.

You can now remove the inner pane and the two middle panes one after the other.

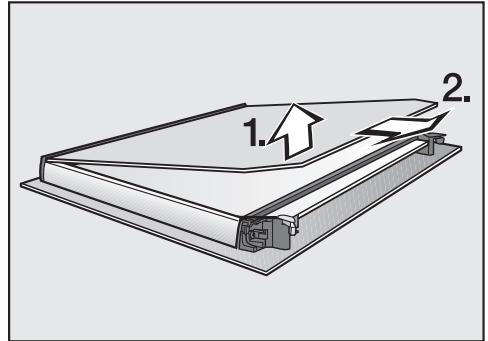

- **Gently** lift the inner pane up and out of the plastic strip.

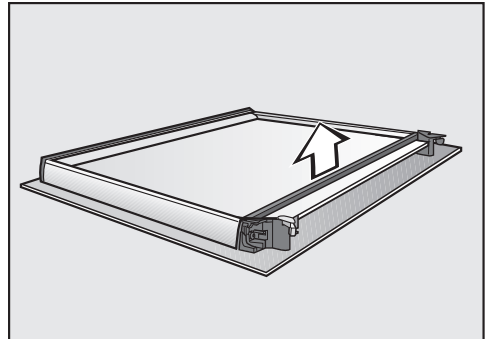

- Remove the seal.

Cleaning and care

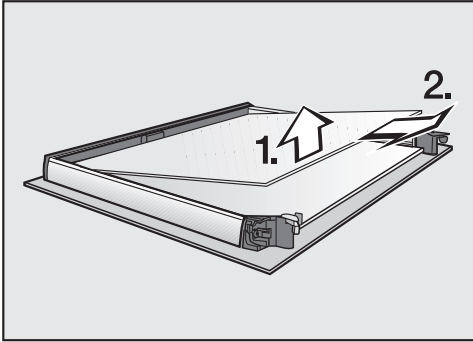

- Gently lift the top of the two middle panes up and take it out.

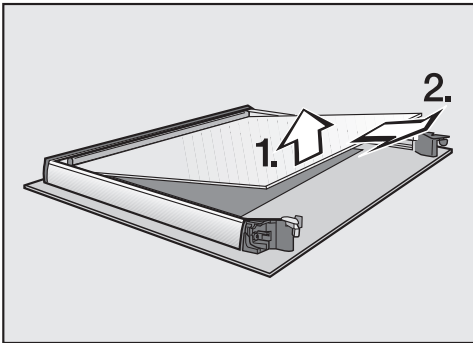

- Then lift the bottom of the two middle panes up carefully and take it out.
- Clean the door panes and other individual parts with a clean sponge and a solution of hot water and washing-up liquid or a clean, damp microfibre cloth.
- Dry all parts with a soft cloth.

Then reassemble the door carefully:

The two middle panes are identical. To help you put them back in correctly, the material number is printed on the panes.

- Refit the lower of the two middle panes in such a way that the material number is legible (i.e. not reversed).

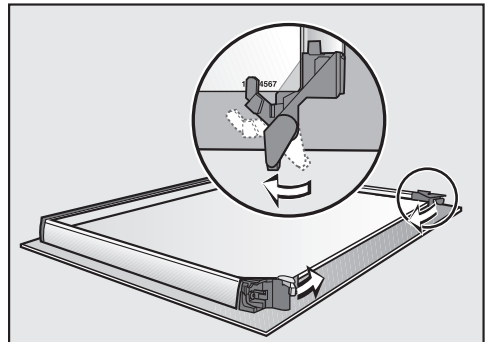

- Flip both the glass pane retainers inwards in such a way that they fit over the lower of the two middle panes.
- Then refit the upper of the middle two panes in such a way that the material number is legible (i.e. not reversed). The glass pane should lie on top of the retainers.

Cleaning and care

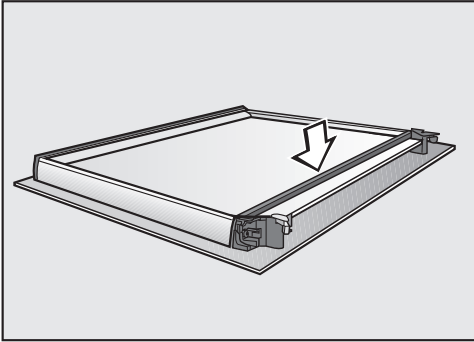

- Refit the seal.

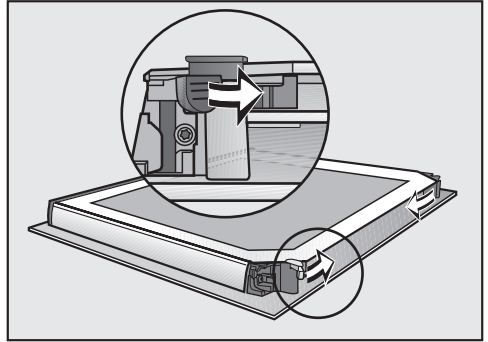

- Flip the two glass pane retainers inwards to close them.

The door is now reassembled and is ready to fit back on the oven.

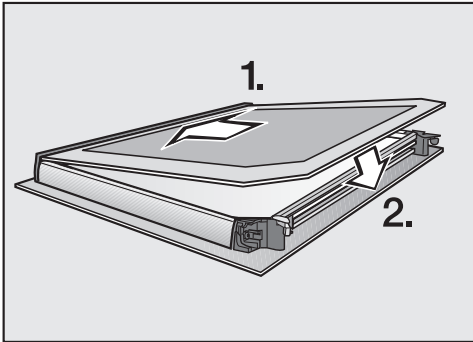

- Push the inner pane with the matt printed side facing downwards into the plastic strip and place it between the retainers.

Cleaning and care

Fitting the door

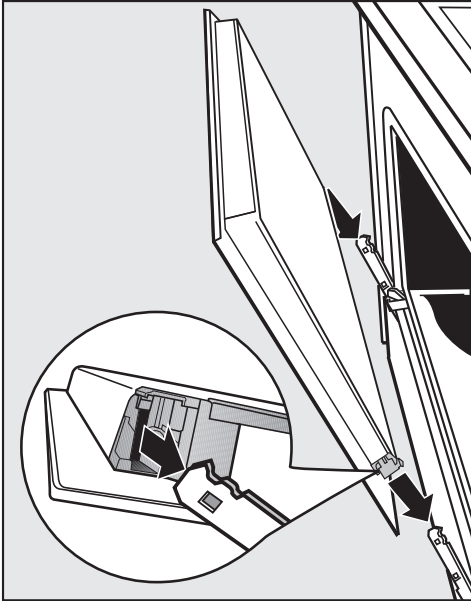

- Hold the door securely on both sides and carefully fit it back into the hinge retainers. Make sure that the door goes back on straight.

- Open the door fully.

If the locking clamps are not locked, the door could work loose resulting in damage.

Ensure that the locking clamps are locked after refitting the door.

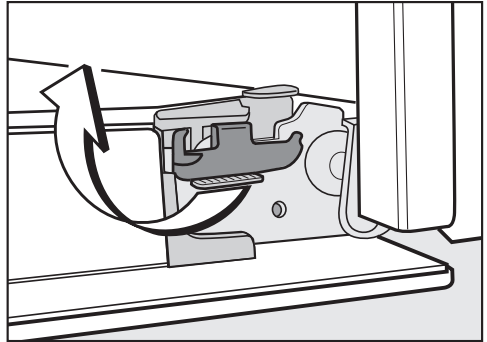

- Flip both locking clamps back up as far as they will go into a horizontal position.

Removing the shelf runners with FlexiClip telescopic runners

You can remove the shelf runners together with the FlexiClip telescopic runners (if present).

If you wish to remove the FlexiClip telescopic runners separately beforehand, please follow the instructions in "Features – Fitting and removing the FlexiClip telescopic runners".

 **Danger of burning!**
Make sure the oven heating elements are switched off and the oven interior is cool.

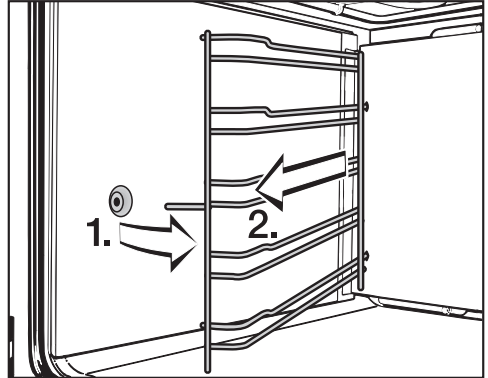

- Pull the runners out of the holder (1) at the front of the oven and then pull them out of the oven (2).

Refit in the reverse order.

- Ensure that all parts are correctly fitted.

Cleaning and care

Lowering the top heat/grill element

⚠ Danger of burning!
Make sure the oven heating elements are switched off and that the oven cavity is cool.

- Remove the shelf runners.

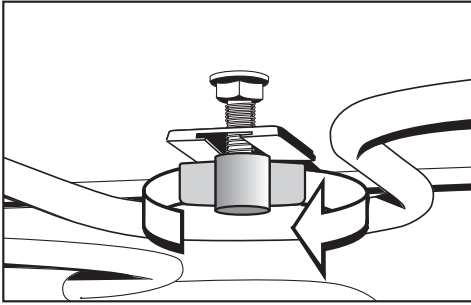

- Undo the wing nut.

Use caution not to damage the top heat/grill element.
Do not use force to lower the top heat/grill element as this can cause it to break.

- Carefully lower the top heat/grill element.

You can now clean the oven ceiling.

- Raise the top heat/grill element and tighten the wing nut securely.
- Refit the shelf runners.

Descaling the steam injection system

When to run the descaling process

The frequency of descaling will depend on the water hardness level in your area.

The descaling process can be run at any time.

However, to ensure that the oven functions correctly, you will be automatically prompted to run the descaling process after a certain number of programmes.

The oven will let you know when only 10 programmes can be run before you have to run the descaling process. The programmes will count down to 0 in the display. You will then not be able to run any function or Automatic programme using moisture. They cannot be used until descaling has been carried out.

All other functions and Automatic programmes without moisture can still be used.

Descaling process sequence

Once the descaling process has been started, it must be completed through to the end. It cannot be cancelled.

The descaling cycle takes approx. 90 minutes and consists of several steps:

1. Preparing the descaling process
2. Drawing in the descaling solution
3. Activation phase
4. Rinse 1
5. Rinse 2
6. Rinse 3
7. Evaporating residual moisture

Cleaning and care

Preparing the descaling process

You will need a container of approx. 1 litre capacity.

A plastic tube (with suction cup) is supplied with your oven so that you do not have to hold the container with the descaling agent underneath the water intake pipe.

We recommend using the descaling tablets supplied. They have been specially developed for Miele appliances for optimum cleaning results.

Other descaling agents, which contain other acids besides citric acid and/or other undesirable substances, such as chlorides for example, could cause damage. Moreover, the descaling effect required could not be guaranteed if the descaling solution was not of the appropriate concentration.

Useful tip: Miele descaling tablets are available to order from the Miele webshop or directly from Miele.

- Completely dissolve one descaling tablet in approx. 600 ml of cold mains tap water.

Starting the descaling process

- Select Maintenance .
- Select Descale.

If the Moisture Plus  function and the Automatic programmes that use moisture are already locked, the descaling process can be started immediately by touching the OK sensor.

- Push the universal tray into the top shelf level as far as it will go to collect the descaling solution after it has been used. Touch OK to confirm the message.

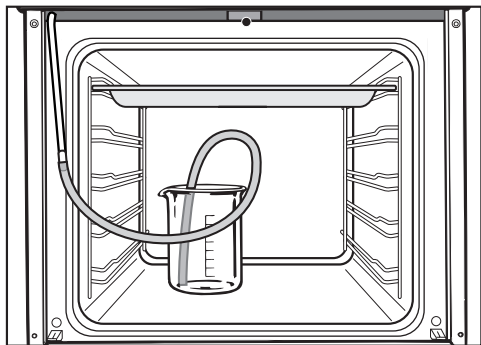

- Place the container with the descaling solution on the floor of the oven.
- Attach the plastic tube to the end of the water intake pipe. Place the other end in the bottom of the descaling solution container, and secure the plastic tube to the container with the suction cup.
- Confirm with *OK*.

The intake process will begin. You can hear the pump while this is happening.

The intake process can be interrupted and restarted at any time by selecting *Stop* or *Start*.

The amount of solution specified can be more than the amount which is actually taken in. Some of the solution may therefore be left in the container at the end of descaling.

A message will appear in the display when the intake process is finished.

- Confirm with *OK*.

The **Activation phase** will begin. You can follow the duration as it counts down.

- Leave the container with the tube connected to the water intake pipe in the oven. Top the container up with approx. 300 ml of water, as the system will need to draw in some more liquid during the activation phase.

The system will take in more liquid at approximately 5 minute intervals. You will hear the noise of the pump for a moment or so.

The oven lighting and the cooling fan will remain on during descaling.

At the end of the activation phase a buzzer will sound if the buzzer is switched on (see "Settings - Volume - Buzzer tones").

Cleaning and care

At the end of the activation phase the steam injection system will need to be cleaned to remove all traces of descaling solution.

Cleaning is carried out by flushing approx. 1 litre of fresh tap water through the system. The water is collected in the universal tray.

- Take the universal tray out of the oven and empty it. Place the tray back in the oven again on the top shelf level.
- Remove the plastic tube from the container.
- Remove the container, rinse and fill it with approx. 1 litre of fresh tap water.
- Place the container back in the oven, insert the plastic tube, secure it to the container and close the door.
- Confirm with *OK*.

The intake process for the **first rinse** starts.

Water will be flushed through the steam injection system and will then collect in the universal tray.

Messages will appear in the display with advice about the **second rinse**.

- Take the universal tray out of the oven and empty it. Place the tray back in the oven again on the top shelf level.
- Remove the plastic tube from the container. Fill it with approx. 1 litre of fresh tap water.
- Place the container back in the oven, insert the plastic tube, secure it to the container and close the door.
- Confirm with *OK*.
- Do the same for the **third rinse**.

Leave the universal tray (with the water which has collected in it) on the top oven shelf whilst the evaporation process takes place.

The **Evaporate residual moisture** process will begin after the third rinse.

- Remove the container and tube from the oven.
- Close the door.
- Confirm with *OK*.

Steam can cause scalding.
Do not open the door while the residual water is being evaporated.

The oven heating will switch on and the duration for the evaporation process will count down in the display.

During the evaporation process, the duration may be adjusted by the system according to how much water is currently present.

At the end of the evaporation process a message will appear in the display with advice on cleaning after running the descaling programme.

- Confirm with *OK*.

A buzzer will sound if the buzzer is switched on (see "Settings – Buzzer tones"). *Process finished* will appear in the display.

- Switch the oven off.

Danger of burning!
Allow the oven interior and accessories to cool down before cleaning them.

- Remove the universal tray and empty it. Clean the oven interior to remove any condensation and descaling agent residue.





Leave the oven door open until the oven interior is completely dry.

Problem solving guide



With the aid of the following guide, minor problems can be easily corrected without contacting Miele. If, after reading this guide, you can't remedy the problem yourself, please call Miele (see back cover for details).

Please note, however, that a call-out charge will be applied to unnecessary service visits where the problem could have been rectified as described in these operating instructions.

 **Danger of injury!** Installation, maintenance and repairs may only be carried out by a suitably qualified and competent person. Repairs and other work by unqualified persons could be dangerous. Miele cannot be held liable for unauthorised work. Do not attempt to open the casing of the appliance yourself.

Problem	Possible cause and remedy
The display is dark.	<p>The time of day display is deactivated, so when the appliance is switched off, the time of day display is switched off.</p> <ul style="list-style-type: none">■ As soon as the oven is switched on, the time of day will appear. If you want it to be displayed constantly, the setting to switch the time of day display back on must be changed (see "Settings – Time of day - Display"). <p>There is no power to the oven.</p> <ul style="list-style-type: none">■ Check whether the mains fuse has tripped. If it has, contact a qualified electrician or Miele.
System lock  appears in the display when the oven is switched on.	<p>The system lock  has been switched on.</p> <ul style="list-style-type: none">■ It can be released for a programme to be run by touching the  symbol for at least 6 seconds.■ The system lock can be permanently deactivated (see "Settings – System lock ").



Problem solving guide

Problem	Possible cause and remedy
<p>The door cannot be opened.</p>	<p>The time of day display is deactivated. When the appliance is switched off, the display is dark and the sensors will not react.</p> <ul style="list-style-type: none"> ■ As soon as the oven has been switched on again the time will reappear in the display and the  sensor will react (see "Settings – Time of day – Clock display").
	<p>The oven is not switched on at the mains.</p> <ul style="list-style-type: none"> ■ Make sure that the plug is correctly inserted in the socket and that the socket switch has been switched to on. ■ Check whether the mains fuse has tripped. If it has, contact a qualified electrician or Miele. ■ If you need to open the door, for instance because there is still food in the oven, use the opener supplied to lever the door open. To do so, push the opener at an angle into the gap between the control panel and the door at the same height as the  sensor. You can also pull the door open by grasping the sides of the door with both hands and pulling carefully until it opens.
	<p>The Pyrolytic cleaning programme has started.</p> <div style="border: 1px solid gray; padding: 5px; margin: 5px 0;"> <p> Danger of burning! During pyrolytic cleaning the oven door will remain locked until the temperature inside the oven drops to below 280 °C. Do not attempt to lever open the door with the opener as described above.</p> </div> <ul style="list-style-type: none"> ■ Wait until the oven has cooled down. The door will unlock itself automatically as soon as the temperature in the oven has dropped below 280 °C.
<p>The oven does not heat up.</p>	<p>Demo mode has been activated. The oven can be operated but does not heat up.</p> <ul style="list-style-type: none"> ■ You need to deactivate the Demo mode (see "Settings - Showroom programme").



Problem solving guide

Problem	Possible cause and remedy
Power cut - process cancelled appears in the display.	<p>There has been a power cut which has caused a current cooking process to stop.</p> <ul style="list-style-type: none"> ■ Switch the oven off and then back on again. ■ Start the programme again.
12:00 appears in the display.	<p>The power supply was interrupted for longer than 200 hours.</p> <ul style="list-style-type: none"> ■ Reset the time and date.
Maximum operating hours reached appears in the display.	<p>The oven has been operating for an unusually long time and this has activated the safety switch-off function.</p> <ul style="list-style-type: none"> ■ Confirm by touching <i>OK</i>. Touch ↵ to delete the message <i>Process finished</i>. <p>The oven is now ready to use.</p>
⚠ Fault XX appears in the display.	<p>There is a problem that you cannot resolve.</p> <ul style="list-style-type: none"> ■ Call Miele.
Door will not lock appears in the display.	<p>The Pyrolytic cleaning programme door lock is not locking.</p> <ul style="list-style-type: none"> ■ Turn the oven off and then back on again. Then restart the Pyrolytic cleaning programme again. ■ If the message appears again, call Miele.
Door will not release appears in the display.	<p>The door lock for the Pyrolytic cleaning programme is not being released.</p> <ul style="list-style-type: none"> ■ Switch the oven off and then back on again. ■ If the door lock still does not deactivate itself, contact Miele.
No signal to food probe. Reposition food probe in the oven appears in the display.	<p>The food probe is no longer recognised by the oven.</p> <ul style="list-style-type: none"> ■ Reposition the food probe in the food. <p>If the oven still does not recognise the food probe, it must be faulty. A replacement food probe can be ordered from Miele.</p>
Function currently not available appears in the display after selecting the Descale function.	<p>The steam injection system is faulty.</p> <ul style="list-style-type: none"> ■ Call Miele.

Problem solving guide

Problem	Possible cause and remedy
Moisture control faulty - Automatic programmes will operate without moisture appears in the display after selecting an Automatic programme.	The steam injection system is faulty. ■ Call Miele. Automatic programmes can be run without using moisture.
Moisture control faulty - Moisture Plus programme is not available appears in the display after selecting Moisture Plus .	The steam injection system is faulty. ■ Call Miele. ■ Use the Fan Plus  function instead of the Moisture Plus  function.
Programmes using moisture will not take in water.	Demo mode is activated. The oven can be operated but the pump for the steam injection system does not work. ■ You need to deactivate the Demo mode (see "Settings - Showroom programme").
	The pump for the steam injection system is faulty. ■ Call Miele.
A noise can be heard after a cooking process.	The fan remains switched on after a cooking programme (see "Settings - Cooling fan run-on").
The oven has switched itself off.	The oven will switch itself off automatically to save energy if no other action is taken within a certain time frame after switching it on or after the end of a cooking programme. ■ Switch the oven back on.
Cakes and biscuits are not baked properly after following the times given in the baking chart.	A different temperature from the one given in the recipe was used. ■ Select the temperature required for the recipe.
	The ingredient quantities are different from those given in the recipe. ■ Check whether there has been a change to the recipe. The addition of more liquid or more eggs makes a moister mix which would take longer to cook.

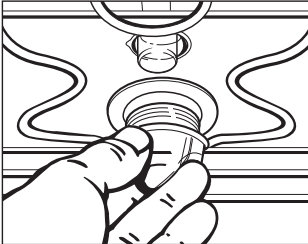
Problem solving guide

Problem	Possible cause and remedy
<p>Browning is uneven.</p>	<p>The wrong temperature or shelf level was selected.</p> <ul style="list-style-type: none"> ■ There will always be a slight unevenness. If the unevenness is pronounced, check whether the correct temperature and shelf level have been selected. <p>The material or colour of the baking tin is not suitable for the oven function.</p> <ul style="list-style-type: none"> ■ With Conventional Heat  light-coloured, shiny tins are less suitable. Use matt, dark-coloured tins. <p>The catalyser has been set at too high a level. This can lead to an uneven browning result on more delicate food such as sponge cakes.</p> <ul style="list-style-type: none"> ■ Set the odour reduction catalyser to a lower level or switch it off (see "Settings - Catalyser").
<p>The oven lighting switches off after a short time.</p>	<p>The oven lighting is set to switch off after 15 seconds (default setting). You can change the default setting for this (see "Settings - Lighting").</p>
<p>The top oven lighting does not switch on.</p> 	<p>The halogen lamp needs replacing.</p> <div style="border: 1px solid gray; padding: 5px; margin: 10px 0;"> <p> Danger of burning! Make sure the oven heating elements are switched off and that the oven cavity is cool.</p> </div> <ul style="list-style-type: none"> ■ Disconnect the appliance from the mains. Switch off at the wall and withdraw the plug from the socket, or switch off at the mains circuit breaker. ■ Turn the lamp cover a quarter turn anti-clockwise to release it and then pull it together with its seal downwards to take it out. ■ Replace it with a new halogen lamp (Osram 66725 AM/A, 230 V, 25 W, G9). ■ Refit the lamp cover together with its seal and turn clockwise to secure. ■ Reconnect the oven to the electricity supply.

Problem solving guide

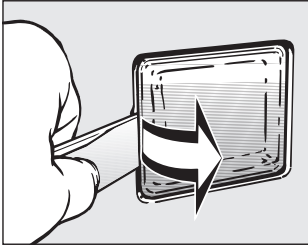
Problem	Possible cause and remedy
<p data-bbox="76 202 356 260">The side oven lighting does not switch on.</p> 	<p data-bbox="400 202 818 229">The halogen lamp needs replacing.</p> <div data-bbox="404 236 1046 363" style="border: 1px solid black; padding: 5px;"> <p data-bbox="418 248 687 284">⚠ Danger of burning!</p> <p data-bbox="418 292 1023 349">Make sure the oven heating elements are switched off and that the oven cavity is cool.</p> </div> <ul data-bbox="400 387 1039 743" style="list-style-type: none"> <li data-bbox="400 387 1016 475">■ Disconnect the appliance from the mains. Switch off at the wall and withdraw the plug from the socket, or switch off at the mains circuit breaker. <li data-bbox="400 483 743 510">■ Remove the shelf runners. <li data-bbox="400 518 1009 576">■ Release the lamp cover from its holder using the tool supplied. <li data-bbox="400 584 893 641">■ Replace it with a new halogen lamp (Osram 66725 AM/A, 230 V, 25 W, G9). <li data-bbox="400 649 1039 707">■ Press the lamp cover back into its retainer and refit the shelf runners. <li data-bbox="400 715 960 743">■ Reconnect the oven to the electricity supply.
<p data-bbox="76 764 370 852">There is soiling in the oven after the Pyrolytic cleaning programme.</p>	<p data-bbox="400 764 1034 821">The Pyrolytic cleaning programme burns off soiling in the oven and leaves it as ash.</p> <ul data-bbox="400 829 1005 917" style="list-style-type: none"> <li data-bbox="400 829 1005 917">■ Remove the ash using warm water with a little washing-up liquid with a soft sponge or a clean, damp microfibre cloth. <p data-bbox="430 925 1034 1013">If coarse soiling remains, run the Pyrolytic cleaning programme again. Select a longer duration if necessary.</p>
<p data-bbox="76 1032 344 1184">The rack and other accessories make a noise when being pushed into or pulled out of the oven.</p>	<p data-bbox="400 1032 1016 1120">The pyrolytic resistant surface of the shelf runners creates friction when accessories are being pushed into or pulled out of the oven.</p> <ul data-bbox="400 1128 1034 1252" style="list-style-type: none"> <li data-bbox="400 1128 1034 1252">■ To reduce the friction, add a few drops of heat resistant cooking oil to some paper towelling and use this to lubricate the shelf runners. Do this after every Pyrolytic cleaning programme.

After sales service and warranty

After sales service

In the event of any faults which you cannot easily remedy, please contact Miele.

See back of this booklet for contact details.

Please quote the model and serial number of your appliance when contacting Miele.

This information is given on the data plate, visible on the front frame of the oven, with the door fully open.

Warranty

The manufacturer's warranty for this appliance is 2 years.

For further information, please refer to your warranty booklet.



Danger of injury!

Installation, repairs and other work by unqualified persons could be dangerous. Miele cannot be held liable for unauthorised work.

Ensure power is not supplied to the appliance until after installation or repair work has been carried out.

All electrical work should be undertaken by a suitably qualified and competent person in strict accordance with current national and local safety and building code regulations.

Connection of this appliance must comply with national and local safety regulations.

Connection to a switched socket is recommended as this provides easier access in the case of a service call.

For extra safety, it is advisable to protect the appliance with a suitable residual current device (RCD) with a trip current of 30 mA.

If the switch is not accessible after installation an additional means of disconnection must be provided for all poles. The means of disconnection must be incorporated in the fixed wiring in accordance with the wiring rules.

When switched off there must be an all-pole contact gap of 3 mm in the isolator switch (including switch, fuses and relays).

Connection data

AC 230V, 50 Hz

The voltage and rated load are given on the data plate situated at the front of the oven frame visible with the oven door open. Please ensure the connection data matches the household supply.

- When contacting Miele, please quote the following:
 - Model number
 - Serial number
 - Connection data (voltage/frequency/maximum rated load).

If the mains connection cable is damaged, it must be replaced by a suitably qualified electrician with a specialist connection cable of type H 05 VV-F, available from Miele, in order to avoid a hazard.

WARNING
THIS APPLIANCE MUST BE
EARTHED

Building-in diagrams

Appliance dimensions and unit cut-out

Dimensions are given in mm.

Installation in a base unit

If the appliance is to be installed under a cooktop, observe the instructions for installation of the cooktop, as well as the building-in depth of the cooktop.

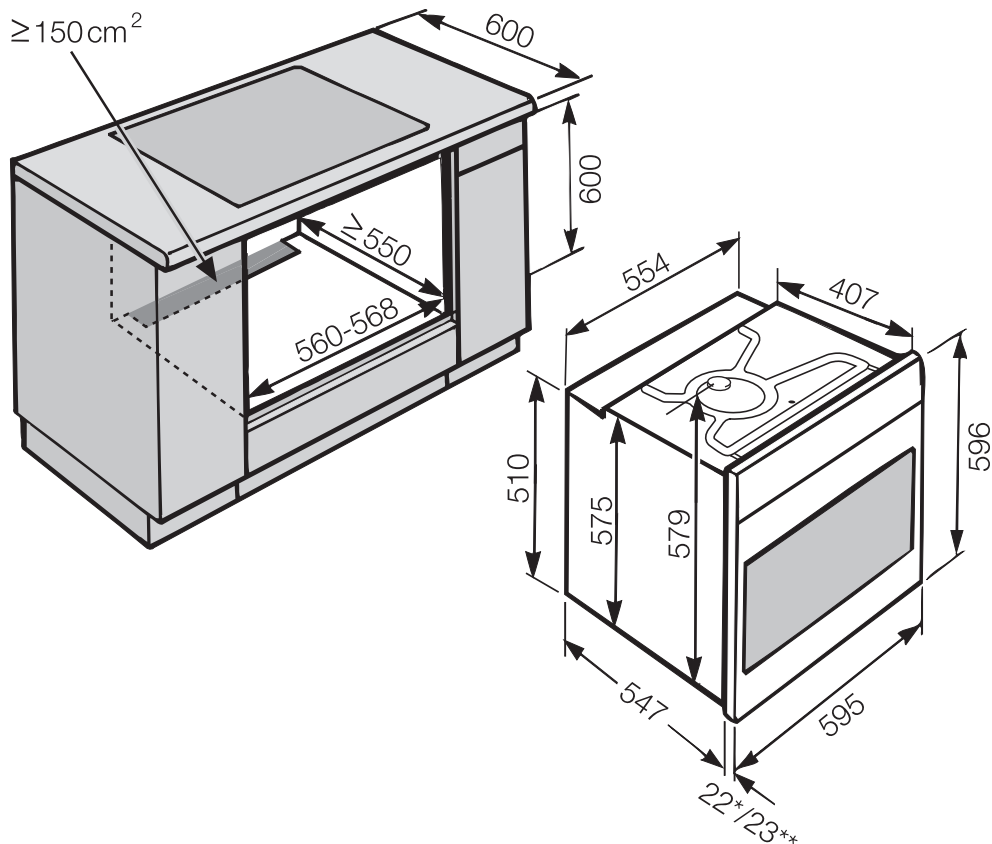

* Ovens with glass front

** Ovens with metal front

Installation in a tall unit

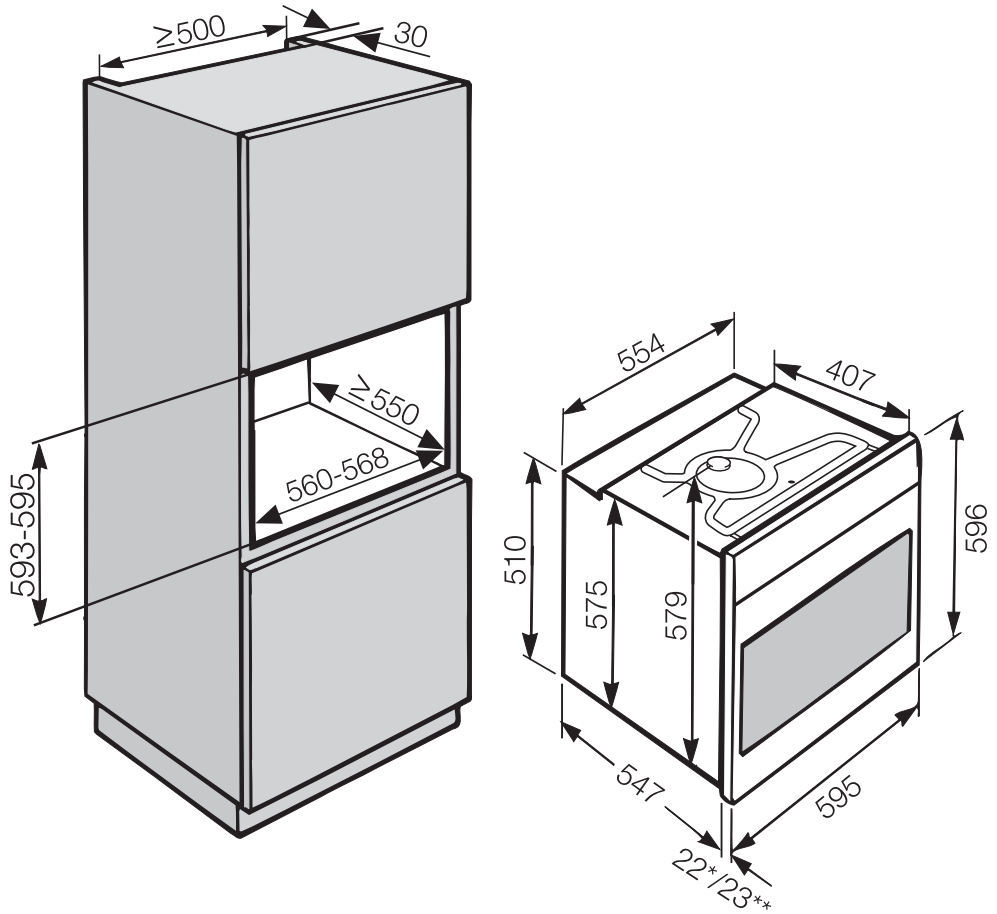

* Ovens with glass front

** Ovens with metal front

Building-in diagrams

Front dimensions

Dimensions are given in mm.

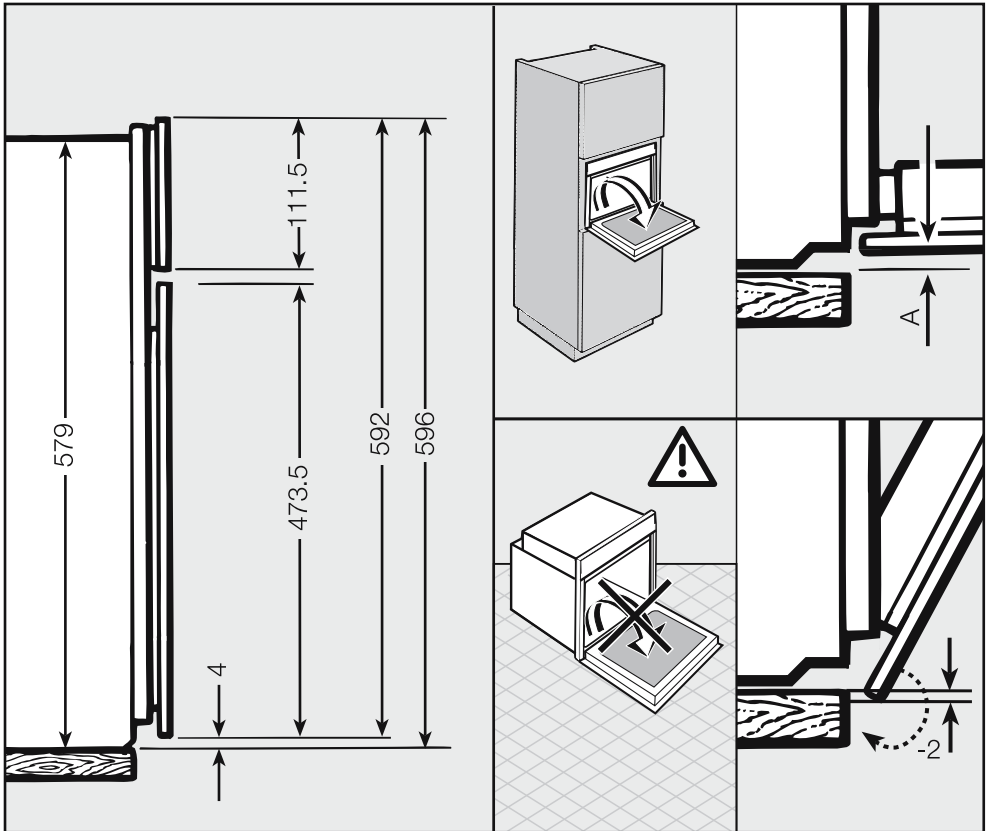

- A** Ovens with glass front: 2.2 mm
Ovens with metal front: 1.2 mm

⚠ The oven must be built into its housing unit before it can be used.

The oven must have an adequate supply of cool air for proper operation. The required air must not be heated excessively by other heat sources, e.g. wood burning stove.

Observe the following when installing:

Do not fit a back panel in the housing unit.

Make sure that the shelf that the oven sits on does not touch the wall.

Do not fit insulation to the side walls of the housing unit.

Before installation

- Before connecting the oven to the mains, you must disconnect the power supply to the oven isolator switch.

Installing the oven

- Connect the mains cable from the oven to the isolator.

Use the handle recesses at the sides of the oven for carrying it. It is advisable to dismantle the door before installing the oven and to remove any accessories from the oven interior. This will make it easier to slide the oven into the housing unit.

- To remove the door, use the opener supplied to lever the door open. Insert the opener into the edge of the door at an angle in the gap between the control panel and the door. You can also pull the door open by

grasping the sides of the door with both hands and pulling carefully until it opens.

- Remove the door (see "Cleaning and care - Dismantling the door") and remove any accessories from the oven interior.
- Push the oven into the housing unit and align it.
- Reconnect the mains power to the isolator switch.
- Open the door by touching the  sensor (if you have not removed it previously).

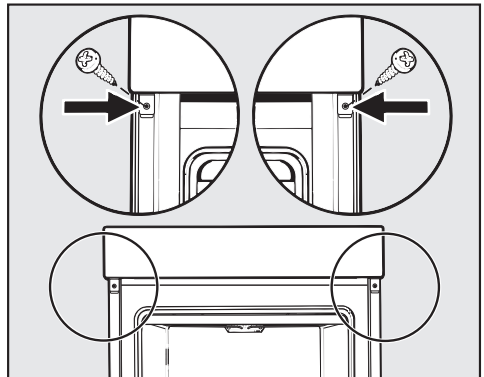

- Use the screws supplied to secure the oven to the side walls of the housing unit through the holes in the oven trim.
- Refit the door, if necessary (see "Cleaning and care - Refitting the door").

Copyright and licences

Miele utilises software for the operation and control of the appliance.

The copyright authorisation of Miele and other software providers (e.g. Adobe) is to be respected at all times.

Miele and its providers reserve all rights to software components.

The following actions are prohibited:

- Reproduction and distribution of the software,
- Generating modifications and derivative versions,
- Decompilation, reverse engineering, disassembling and other reductions of the software.

This product contains Adobe® Flash® Player Software under licence from Adobe Systems Incorporated, Adobe Macromedia Software LLC. Adobe and Flash are registered trademarks of Adobe Systems Incorporated.

Components are integrated in the software which fall under GNU General Public Licence and Open Source licences.

You can obtain an overview of the integrated Open Source components, along with a copy of the relevant licence, at www.miele.com/device-software-licences after entering your appliance's model code.

Miele can provide the source code for all software components licenced under GNU General Public Licence and comparable Open Source licences.

To obtain the relevant source code, please send an e-mail to info@miele.com.

Miele Australia Pty. Ltd.

ACN 005 635 398
ABN 96 005 635 398

**Miele Experience Centre and
Head Office Melbourne:**

1 Gilbert Park Drive
Knoxfield, VIC 3180

Miele Experience Centre South Melbourne:

206-210 Coventry Street
South Melbourne, VIC 3205

Miele Experience Centre and Office Sydney:

3 Skyline Place
Frenchs Forest, NSW 2086

Miele Experience Centre and Office Brisbane:

39 Harvey Street North
Eagle Farm, QLD 4009

Miele Experience Centre Gold Coast:

131 Ferry Road
Southport, QLD 4215

Miele Experience Centre and Office Adelaide:

83-85 Sir Donald Bradman Drive
Hilton, SA 5033

Miele Experience Centre and Office Perth:

205-207 Stirling Highway
Claremont, WA 6010



www.miele.com.au



Miele New Zealand Limited

IRD 98 463 631

Head Office:

Level 2, 10 College Hill
Freemans Bay, Auckland 1011

**Miele Experience Centre
Auckland:**

8 College Hill
Freemans Bay, Auckland 1011
Telephone:
0800 464 353 (0800 4 MIELE)
www.miele.co.nz

Miele Global Headquarters

Germany

Miele & Cie. KG

Carl-Miele-Straße 29
33332 Gütersloh
Federal Republic of Germany

H6860BPX



en-AU, NZ

M.-Nr. 10 483 990 / 00