

JVC



MICRO COMPONENT SYSTEM

UX-G200

—Consists of CA-UXG200 and SP-UXG200

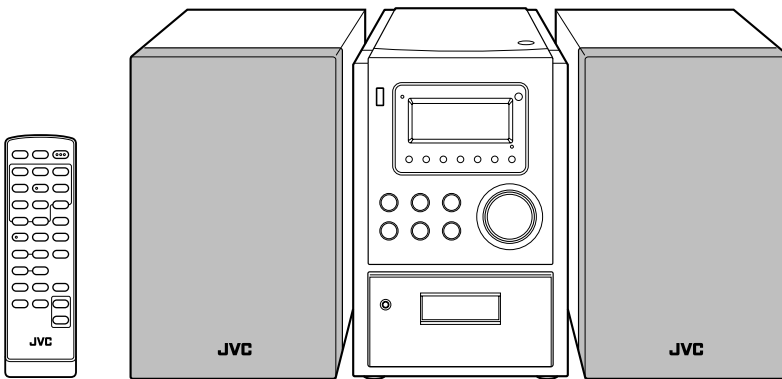

COMPACT
disc
DIGITAL AUDIO

MP3/WMA

INSTRUCTIONS

For Customer Use:

Enter below the Model No. and Serial No. which are located either on the rear, bottom or side of the cabinet. Retain this information for future reference.

Model No. _____

Serial No. _____

LVT1956-005A

[J]

Warnings, Cautions and Others

Mises en garde, précautions et indications diverses

	CAUTION RISK OF ELECTRIC SHOCK DO NOT OPEN	
CAUTION: TO REDUCE THE RISK OF ELECTRIC SHOCK, DO NOT REMOVE COVER (OR BACK). NO USER SERVICEABLE PARTS INSIDE. REFER SERVICING TO QUALIFIED SERVICE PERSONNEL.		

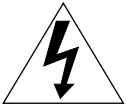

The lightning flash with arrowhead symbol, within an equilateral triangle, is intended to alert the user to the presence of uninsulated "dangerous voltage" within the product's enclosure that may be of sufficient magnitude to constitute a risk of electric shock to persons.



The exclamation point within an equilateral triangle is intended to alert the user to the presence of important operating and maintenance (servicing) instructions in the literature accompanying the appliance.

	ATTENTION RISQUE D'ÉLECTROCUTION NE PAS OUVRIR	
ATTENTION: POUR ÉVITER TOUT RISQUE D'ÉLECTROCUTION, NE PAS OUVRIR LE BOÎTIER. AUCUNE PIÈCE INTÉRIEURE N'EST À RÉGLER PAR L'UTILISATEUR. SE RÉFÉRER À UN AGENT QUALIFIÉ EN CAS DE PROBLÈME.		



Le symbole de l'éclair à l'intérieur d'un triangle équilatéral est destiné à alerter l'utilisateur sur la présence d'une "tension dangereuse" non isolée dans le boîtier du produit. Cette tension est suffisante pour provoquer l'électrocution de personnes.



Le point d'exclamation à l'intérieur d'un triangle équilatéral est destiné à alerter l'utilisateur sur la présence d'opérations d'entretien importantes au sujet desquelles des renseignements se trouvent dans le manuel d'instructions.

WARNING: TO REDUCE THE RISK OF FIRE OR ELECTRIC SHOCK, DO NOT EXPOSE THIS APPLIANCE TO RAIN OR MOISTURE.

Note to CATV system installer:

This reminder is provided to call the CATV system installer's attention to section 820-40 of the NEC which provides guidelines for proper grounding and, in particular, specifies that the cable ground shall be connected to the grounding system of the building, as close to the point of cable entry as practical.

For U.S.A.

This equipment has been tested and found to comply with the limits for a Class B digital device, pursuant to part 15 of the FCC Rules. These limits are designed to provide reasonable protection against harmful interference in a residential installation.

This equipment generates, uses and can radiate radio frequency energy and, if not installed and used in accordance with the instructions, may cause harmful interference to radio communications. However, there is no guarantee that interference will not occur in a particular installation. If this equipment does cause harmful interference to radio or television reception, which can be determined by turning the equipment off and on, the user is encouraged to try to correct the interference by one or more of the following measures:

Reorient or relocate the receiving antenna.

Increase the separation between the equipment and receiver.

Connect the equipment into an outlet on a circuit different from that to which the receiver is connected.

Consult the dealer or an experienced radio/TV technician for help.

For Canada/pour le Canada

THIS DIGITAL APPARATUS DOES NOT EXCEED THE CLASS B LIMITS FOR RADIO NOISE EMISSIONS FROM DIGITAL APPARATUS AS SET OUT IN THE INTERFERENCE-CAUSING EQUIPMENT STANDARD ENTITLED "DIGITAL APPARATUS," ICES-003 OF THE DEPARTMENT OF COMMUNICATIONS.

CET APPAREIL NUMÉRIQUE RESPECTE LES LIMITES DE BRUITS RADIOÉLECTRIQUES APPLICABLES AUX APPAREILS NUMÉRIQUES DE CLASSE B PRÉSCRITES DANS LA NORME SUR LE MATÉRIEL BROUILLEUR; "APPAREILS NUMÉRIQUES", NMB-003 ÉDICTÉE PAR LE MINISTRE DES COMMUNICATIONS.

CAUTION

To reduce the risk of electrical shocks, fire, etc.:

1. Do not remove screws, covers or cabinet.
2. Do not expose this appliance to rain or moisture.

ATTENTION

Afin d'éviter tout risque d'électrocution, d'incendie, etc.:

1. Ne pas enlever les vis ni les panneaux et ne pas ouvrir le coffret de l'appareil.
2. Ne pas exposer l'appareil à la pluie ni à l'humidité.

CAUTION:

Excessive sound pressure from earphones or headphones can cause hearing loss.

ATTENTION:

Une pression acoustique excessive des écouteurs ou du casque d'écoute peut entraîner une perte auditive.

CAUTION

Battery shall not be exposed to excessive heat such as sunshine, fire or the like.

ATTENTION

Les piles ne doivent en aucun cas être exposées à une chaleur excessive (lumière du soleil, feu, etc.).

CAUTION

The \odot/I button in any position does not disconnect the mains line.

Disconnect the mains plug to shut the power off completely (the STANDBY lamp goes off).

The MAINS plug or an appliance coupler is used as the disconnect device, the disconnect device shall remain readily operable.

- When the system is on standby, the STANDBY lamp lights red.
- When the system is turned on, the STANDBY lamp goes off. The power can be remote controlled.

ATTENTION

La touche \odot/I , quelle que soit sa position, ne coupe pas la ligne principale.

Débrancher la fiche principale pour couper complètement l'alimentation du secteur (le témoin STANDBY s'éteint).

La fiche secteur ou un coupleur est utilisé comme dispositif de déconnexion de l'appareil, et l'appareil déconnecté doit être prêt à être utilisé.

- Quand l'appareil est en mode d'attente, le témoin STANDBY est allumé en rouge.
- Quand l'appareil est sous tension, le témoin STANDBY s'éteint.

L'alimentation peut être commandée à distance.

CAUTION

- Do not block the ventilation openings or holes. (If the ventilation openings or holes are blocked by a newspaper or cloth, etc., the heat may not be able to get out.)
- Do not place any naked flame sources, such as lighted candles, on the apparatus.
- When discarding batteries, environmental problems must be considered and local rules or laws governing the disposal of these batteries must be followed strictly.
- Do not expose this apparatus to rain, moisture, dripping or splashing and that no objects filled with liquids, such as vases, shall be placed on the apparatus.

ATTENTION

- Ne bloquez pas les orifices ou les trous de ventilation. (Si les orifices ou les trous de ventilation sont bloqués par un journal un tissu, etc., la chaleur peut ne pas être évacuée correctement de l'appareil.)
- Ne placez aucune source de flamme nue, telle qu'une bougie, sur l'appareil.
- Lors de la mise au rebut des piles, veuillez prendre en considération les problèmes de l'environnement et suivre strictement les règles et les lois locales sur la mise au rebut des piles.
- N'exposez pas cet appareil à la pluie, à l'humidité, à un égouttement ou à des éclaboussures et ne placez pas des objets remplis de liquide, tels qu'un vase, sur l'appareil.

CAUTION

Changes or modifications not approved by JVC could void the user's authority to operate the equipment.

IMPORTANT FOR LASER PRODUCTS

1. CLASS 1 LASER PRODUCT
2. **CAUTION:** Do not open the top cover or cabinet. There are no user serviceable parts inside the unit; leave all servicing to qualified service personnel.
3. **CAUTION:** Visible and/or invisible class 1M laser radiation when open. Do not view directly with optical instruments.
4. REPRODUCTION OF LABEL: CAUTION LABEL, PLACED INSIDE THE UNIT.

IMPORTANT POUR PRODUITS LASER

1. PRODUIT LASER CLASSE 1
2. **ATTENTION:** N'ouvrez pas le couvercle supérieur ni le coffret de l'appareil. Il n'y a aucune pièce réparable par l'utilisateur à l'intérieur de l'appareil; confiez toute réparation à un personnel qualifié.
3. **ATTENTION:** Rayonnement laser visible et/ou invisible de classe 1M une fois ouvert. Ne pas regarder directement avec des instruments optiques.
4. REPRODUCTION DE L'ÉTIQUETTE: ÉTIQUETTE DE PRÉCAUTION PLACÉE À L'INTERIEUR DE L'APPAREIL.

CAUTION VISIBLE AND/OR INVISIBLE CLASS 1M LASER RADIATION WHEN OPEN. DO NOT VIEW DIRECTLY WITH OPTICAL INSTRUMENTS. IC60089-12001 ENGB OPTIQUES.	ATTENTION RAYONNEMENT LASER VISIBLE ET/OU INVISIBLE DE CLASSE 1M UNE FOIS OUVERT. NE PAS REGARDER DIRECTEMENT AVEC DES INSTRUMENTS OPTIQUES.	AVISO RADIACION LASER DE CLASE 1M VISIBLE VEO INVISIBLE CUANDO ESTA ABERTO. NO MIRAR DIRECTAMENTE CON INSTRUMENTAL OPTICA.	VARNING SYNLIG OCH/ELLER OINVLIG LASER STRÅLNING, KLASS 1M, NÅR DENNA DEL ÄR ÖPPNAD. BETRÄCKA EJ STYLLER MED OPTISKA INSTRUMENT.	注意 二光束（可視光 及び不可視光） レーザー放射線 が、この装置を開 いたときに発生し ます。必ず、直 接、光学器具を用 いて見ないでし てください。 LW4009-000A JPNP	CAUTION VISIBLE AND/OR INVISIBLE CLASS II LASER RADIATION WHEN OPEN. DO NOT VIEW INTO BEAM. FOR 21 CVM (ENGB) LW4009-000A
--	--	--	--	--	---

Caution: Proper Ventilation

To avoid risk of electric shock and fire, and to prevent damage, locate the apparatus as follows:

1. Front: No obstructions and open spacing.
2. Sides/ Top/ Back: No obstructions should be placed in the areas shown by the dimensions below.
3. Bottom: Place on the level surface. Maintain an adequate air path for ventilation by placing on a stand with a height of 10 cm (3-15/16") or more.

Attention: Aération correcte

Pour prévenir tout risque de décharge électrique ou d'incendie et éviter toute détérioration, installez l'appareil de la manière suivante:

1. Avant: Bien dégagé de tout objet.
2. Côtés/dessus/dessous: Assurez-vous que rien ne bloque les espaces indiqués sur le schéma ci-dessous.
3. Dessous: Posez l'appareil sur une surface plane et horizontale. Veillez à ce que sa ventilation correcte puisse se faire en le plaçant sur un support d'au moins dix centimètres de hauteur.

Front
Face

Side
Côté

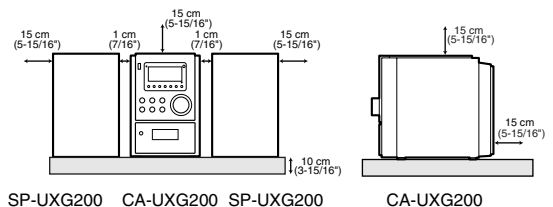

[European Union only]
[Union européenne seulement]

Introduction

Thank you for purchasing a JVC product. Please read all instructions carefully before operation, to ensure your complete understanding and to obtain the best possible performance from the unit.

Precautions

Installation

- Install in a place which is level, dry and neither too hot nor too cold—between 5°C (41°F) and 35°C (95°F).
- Install the System in a location with adequate ventilation to prevent internal heat buildup inside the System.



DO NOT install the System in a location near heat sources, or in a place subject to direct sunlight, excessive dust or vibration.

- Leave sufficient distance between the System and the TV.
- Keep the speakers away from the TV to avoid interference with TV.

Power sources

- When unplugging the System from the wall outlet, always pull on the plug, not the AC power cord.



DO NOT handle the AC power cord with wet hands.

Moisture condensation

Moisture may condense on the lenses inside the System in the following cases:

- After starting to heat the room
- In a damp room
- If the System is brought directly from a cold to a warm place. Should this occur, the System may malfunction. In this case, leave the System turned on for a few hours until the moisture evaporates, unplug the AC power cord, then plug it in again.



For safety, observe the following carefully:

- Make sure there is good ventilation around the main unit. Poor ventilation could overheat and damage the System.
- DO NOT block the ventilation openings or holes. If they are blocked by a newspaper or cloth, etc., the heat may not be able to get out.

Others

- Should any metallic object or liquid fall into the System, unplug the AC power cord and consult your dealer before operating any further.



DO NOT disassemble the System since there are no user serviceable parts inside.

- If you are not going to operate the System for an extended period of time, unplug the AC power cord from the wall outlet.

If anything goes wrong, unplug the AC power cord and consult your dealer.

How to Read This Manual

To make this manual as simple and easy-to-understand as possible, we have adapted the following methods:

- Button and control operations are explained as listed in the table below. In this manual, the operations using the remote control is mainly explained; however, you can use the buttons and controls on the main unit if they have the same (or similar) name and marks.
- **Some related tips and notes are explained later in the sections “Learning More about This System” and “Troubleshooting,” but not in the same section explaining the operations.** If you want to know more about the functions, or if you have a doubt about the functions, go to these sections and you will find the answers.

	Indicates that you press the button briefly .
	Indicates that you press the button briefly and repeatedly until an option you want is selected.
	Indicates that you press one of the buttons.
	Indicates that you press and hold the button for specified seconds. <ul style="list-style-type: none"> • The number inside the arrow indicates the period of press (in this example, 2 seconds). • If no number is inside the arrow, press and hold until the entire procedure is complete or until you get a result you want.
	• Indicates that you turn the control toward the specified direction(s).
	Indicates that this operation is only possible using the remote control.
	Indicates that this operation is only possible using the buttons and controls on the main unit.

Contents

Getting Started	3
Step 1: Unpack	3
Step 2: Prepare the Remote Control	3
Step 3: Hook Up	4
Before Operating the System	6
Daily Operations—Playback	7
Listening to the Radio	8
Playable Media and Files.....	9
Playing Back a Disc.....	9
Playing Back a USB Mass Storage Class Device	9
Playing Back Discs/Files	10
Playing Back Other Equipment	10
Daily Operations—Sound & Other	
Adjustments	11
Adjusting the Volume	11
Adjusting the Sound	11
Setting the Clock	12
Turning Off the Power Automatically—Sleep Timer	12
Advanced Disc/USB Mass Storage Class Device	
Operations	13
Programming the Playing Order— Program Play	13
Playing at Random—Random Play	15
Playing Repeatedly—Repeat Play	15
Daily Timer Operations	16
Setting the Daily Timer	16
Additional Information	18
Learning More about This System	18
Troubleshooting	19
Maintenance	20
Specifications	21
Parts Index	22

Getting Started

Step 1: Unpack the package and check the accessories.

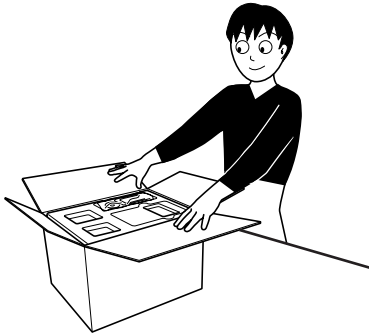

Step 1: Unpack

After unpacking, check to be sure that you have all the following items. The number in parentheses indicates the quantity of each piece supplied.

- FM antenna (1)
- AM loop antenna (1)
- Remote control (1)
- Batteries (2)

If any item is missing, consult your dealer immediately.

Step 2: Prepare the Remote Control

Insert the batteries into the remote control by matching the polarity (+ and -) correctly.

- If the range or effectiveness of the remote control decreases, replace both batteries.

Step 2: Prepare the remote control.

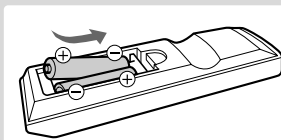

1

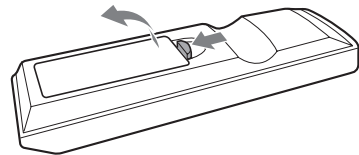

2

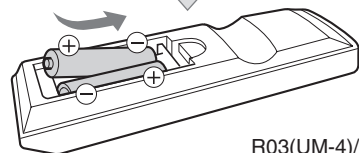

3

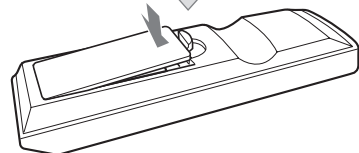

Step 3: Connect the AM/FM antennas and speakers (see pages 4 and 5).

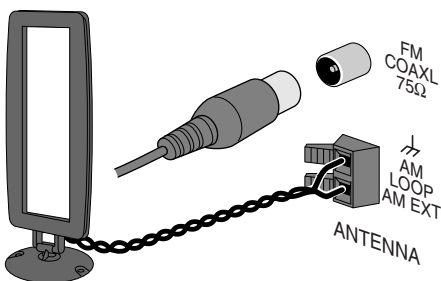

Finally plug the AC power cord.
Now you can operate the System.

Step 3: Hook Up

If you need more detailed information, see page 5.

Turn the power off to all components before connections.

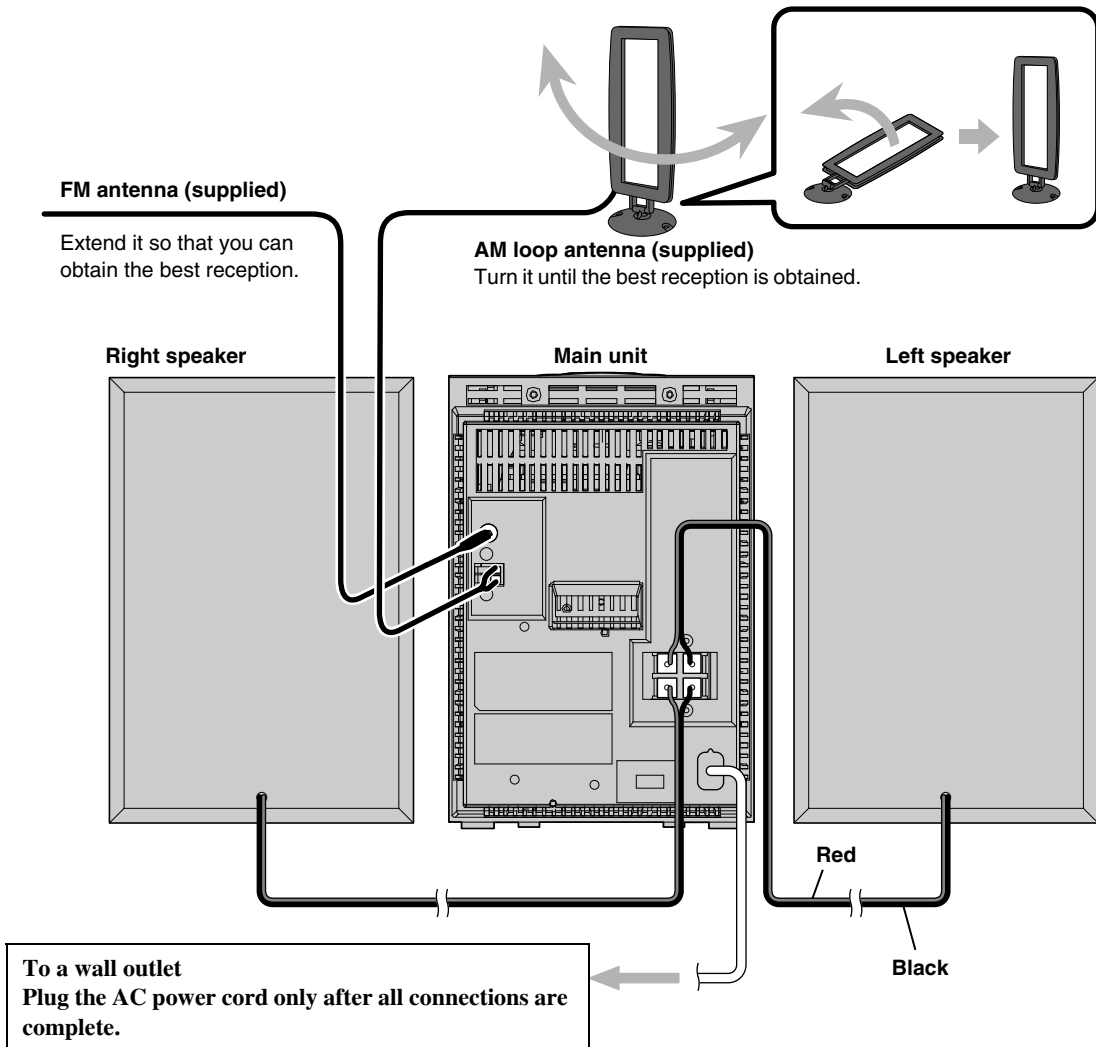

To connect the AM loop antenna

Make sure to connect the wire correctly.

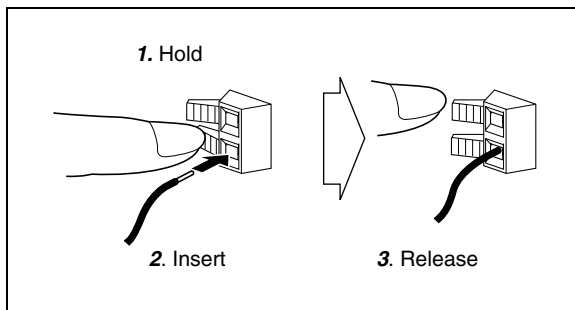

For better FM/AM reception

Outdoor FM antenna (not supplied)

Disconnect the supplied FM antenna, and connect to an outdoor FM antenna using a 75 Ω wire with coaxial type connector.

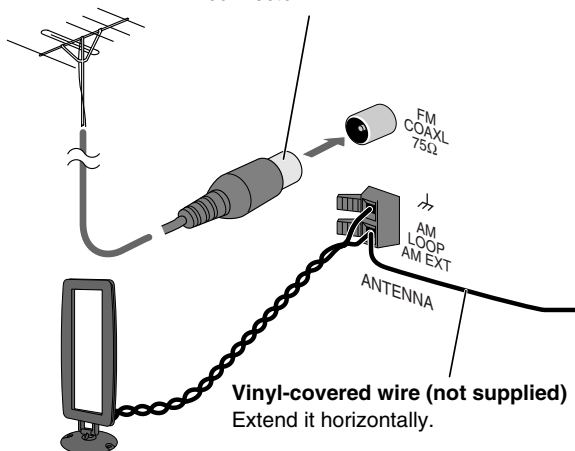

AM loop antenna

Keep it connected.

- Make sure the antenna conductors do not touch any other terminals, connecting cords and the AC power cord. Also, keep the antenna away from metallic parts of the System, connecting cords, and the AC power cord. This could cause poor reception.

To connect the speaker cords

Make sure the both speakers are connected correctly and firmly.

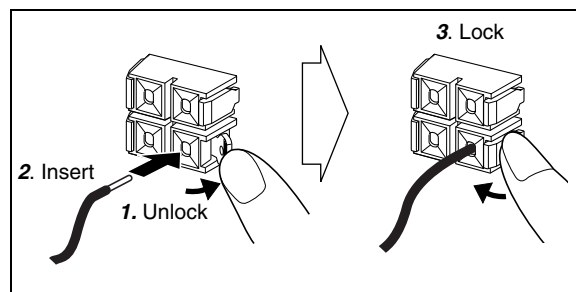

When connecting the speaker cords, match the polarity of the speaker terminals: The black cord to (-), the red cord to (+).



- DO NOT connect more than one speaker to each terminal.
- DO NOT allow the conductor of the speaker cords to be in touch with the metallic parts of the System.



memo

- If the AM loop antenna wire or speaker cords are covered with vinyl, remove the vinyl to expose the tip of the antenna wire or speaker cords by twisting the vinyl.

Before Operating the System

The indications on the display teach you a lot of things while you are operating the System.

Before operating the System, be familiar with when and how the indicator illuminates on the display.

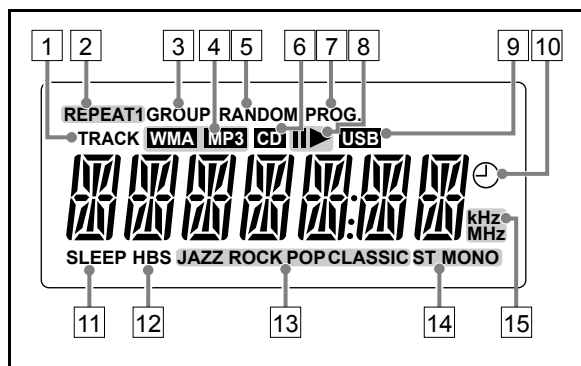

- 1 TRACK indicator
 - Lights when a disc or USB mass storage class device is played.
- 2 REPEAT mode indicators (REPEAT1/REPEAT/REPEAT GROUP)
 - Lights when Repeat Play is activated.
- 3 GROUP indicator
 - Lights when playback of MP3/WMA on a disc or USB mass storage class device stops.
- 4 MP3/WMA indicators
 - Lights when MP3/WMA file is detected.
- 5 RANDOM indicator
 - Lights when Random Play is activated.
- 6 CD indicator
 - Lights when an audio CD is detected.
- 7 PROG. (Program) indicator
 - Lights when preset station is selected.
 - Lights when Program Play is activated.
- 8 Play/pause indicators
 - ►: Lights when a disc/USB mass storage class device is played back.
 - ■: Lights when a disc/USB mass storage class device is paused.
- 9 USB indicator
 - Lights when a USB mass storage class device is connected.
 - Flashes when it is played back.
- 10 (Timer) indicator
 - Lights when Daily Timer is on standby; flashes while it is working.
- 11 SLEEP indicator
 - Lights when the Sleep Timer is activated.
- 12 HBS indicator
 - Lights when HBS (Hyper Bass Sound) mode is activated.
- 13 Sound Mode indicators
 - Lights when one of the Sound Modes is activated.
- 14 FM reception indicator
 - ST: Lights while FM stereo station with sufficient signal strength is tuned in.
 - MONO: Lights while the FM monaural mode is activated.
- 15 Frequency indicators
 - kHz: Lights to indicate AM frequency.
 - MHz: Lights to indicate FM frequency.

Indications on the main display

Tuner:

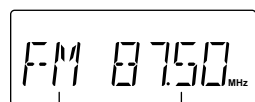

Band Frequency

AUDIO IN:

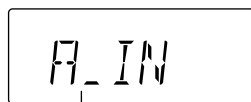

Source name

DISC:

• While playing a CD:

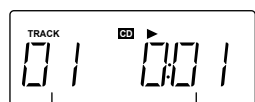

Track number Elapsed playing time

• While stopped:

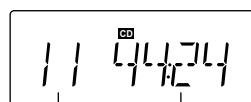

Total track number Total playing time

• While playing an MP3:

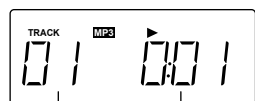

Track number in current group Elapsed playing time

• While stopped:

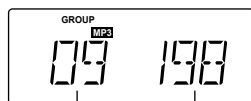

Total group number Total track number

USB MEMORY:

• While playing:

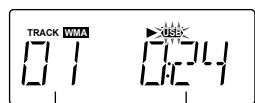

Current track number Elapsed playing time

• While stopped:

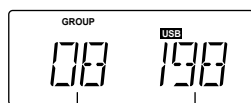

Total group number Total track number

Daily Operations—Playback

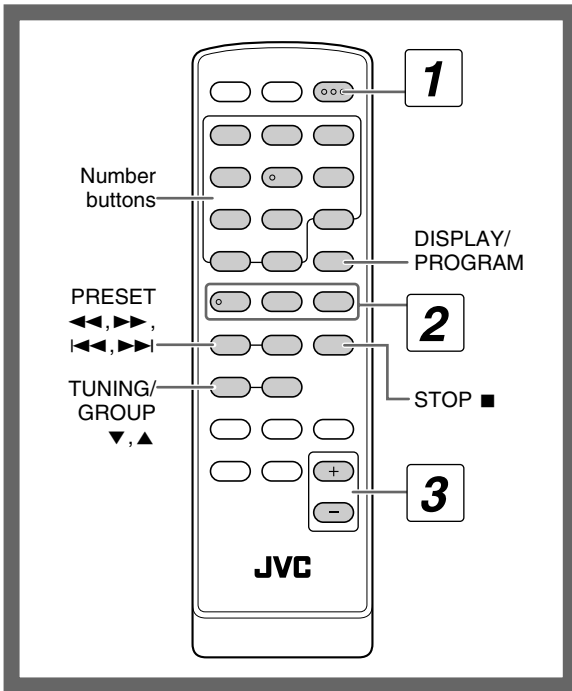

- 1 **Turn on the power.**
The STANDBY lamp on the main unit turns off.
- 2 **Select the source.**
Playback automatically starts if the selected source is ready to start.
 - If you select AUDIO IN, start playback source on the external component.
- 3 **Adjust the volume.**
- 4 **Operate the target source as explained later.**

To turn off (standby) the System

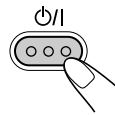

The STANDBY lamp on the main unit lights up.

- A small amount of power is always consumed even while on standby.

For private listening

Connect a pair of headphones to the PHONES jack on the main unit. The sound will no longer come out of the speakers. **Be sure to turn down the volume before connecting or putting the headphones.**

- Disconnecting the headphones will activate the speakers again.

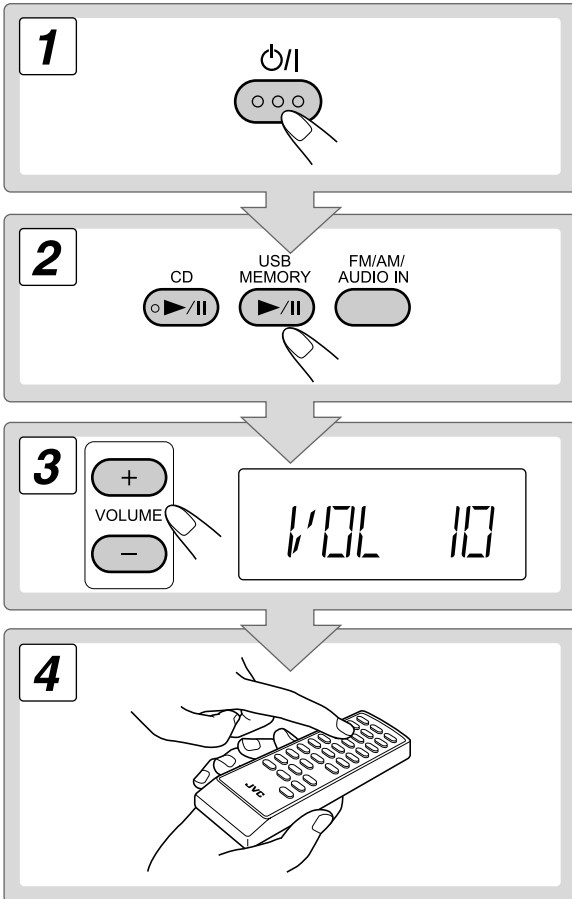

DO NOT turn off (standby) the System with the volume set to an extremely high level; otherwise, the sudden blast of sound can damage your hearing, speakers and/or headphones when you turn on the System or start playback again.



How to select numbers

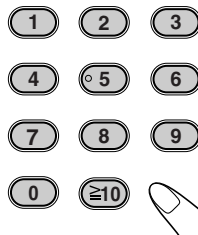

Examples:

To select number 5,
press 5.

To select number 20, press ≥ 10
→ 2 → 0 (when “--” appears),
or press ≥ 10 → 0 → 2 → 0
(when “-- --” appears).

To select number 125,
press ≥ 10 → 1 → 2 → 5.

Listening to the Radio

To select the band (FM or AM)

From the remote control:



On the main unit:

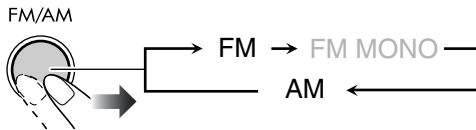

To tune in to a station

While FM or AM is selected...

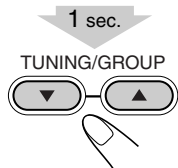

Station searching starts and the frequency indication starts changing on the display.

When a station (frequency) with sufficient signal strength is tuned in, the searching will stop.

To stop searching manually, press either button.

- When you press the button repeatedly, the frequency changes step by step.

If the received FM station is hard to listen

From the remote control:



On the main unit:



Reception will improve though stereo effect is lost. The MONO indicator lights up.

To restore the stereo effect, press the button repeatedly to select FM.

To preset the stations

You can preset 20 FM and 10 AM stations.

1 Tune in to a station you want to preset.

2 Activate the preset number entry mode.

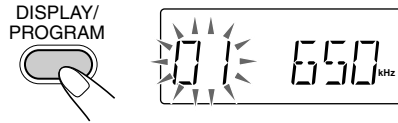

- Finish the following process while the indication on the display is flashing.

3 Select a preset number for the station.

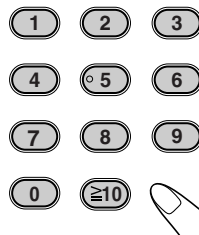

To select a number, see "How to select numbers" on page 7.

- You can also use ◀◀ or ▶▶.

4 Store the station.

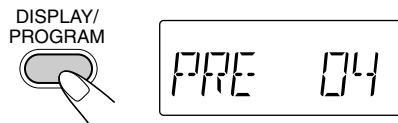

To tune in to a preset station

1 Select a band (FM or AM).

From the remote control:



On the main unit:



2 Select a number of the preset station.

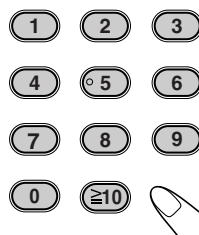

To select a number, see "How to select numbers" on page 7.

- You can also use ◀◀ or ▶▶.

The PROG. indicator lights up on the display.

Playable Media and Files

This System can play back following types of discs/files.

- Audio CD
- MP3/WMA files on a CD-R, CD-RW, or USB mass storage class device

Audio CD	CD-R	CD-RW
		

- This System may not play back some files even though their formats are listed above.
- In this manual, “file” and “track” are used interchangeably for MP3 and WMA operations.

- **Caution for DualDisc playback**
The Non-DVD side of a “DualDisc” does not comply with the “Compact Disc Digital Audio” standard. Therefore, the use of Non-DVD side of a DualDisc on this product may not be recommended.

- Microsoft and Windows Media are either registered trademarks or trademarks of Microsoft Corporation in the United States and/or other countries.



Playing Back a Disc

To place a disc

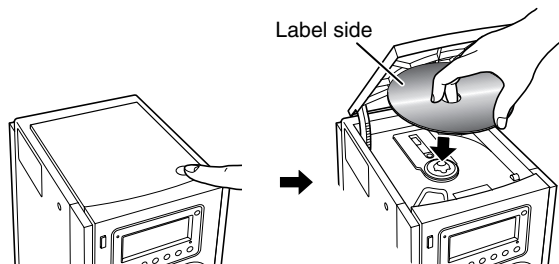
- You can place a disc while playing another source.



To play back a disc

To start:	To pause:	To stop:
	 To release, press again.	

Playing Back a USB Mass Storage Class Device

You can connect a USB mass storage class device such as a USB flash memory device, Digital Audio Player (DAP) to this System.

IMPORTANT

- You cannot connect a computer to the USB MEMORY terminal of the System.
- When connecting with a USB cable, use the USB 2.0 cable whose length is less than 1 m (3.3 ft).
- Always set volume to the minimum level when connecting or disconnecting the USB mass storage class device.

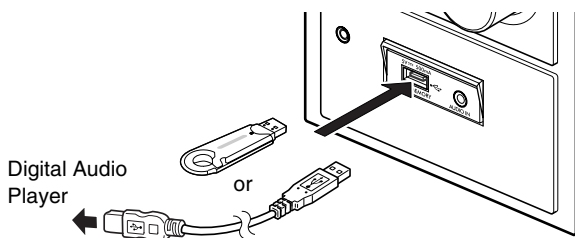

To connect the USB mass storage class device

When connecting a USB mass storage class device, refer also to its manual.



- When disconnecting the USB mass storage class device, make sure that the playback is stopped.

To play back files on the USB mass storage class device

To start:	To pause:	To stop:
		

- The USB indicator on the display lights while USB MEMORY is selected.

Playing Back Discs/Files

To select a track/group

To select a track:

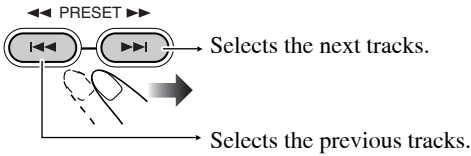

To select a group (MP3/WMA only):

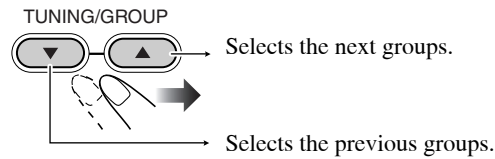

To locate a particular portion

While playing a disc, press and hold until the portion you want is reached.

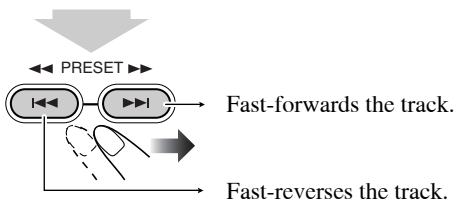

To locate a track directly and start play

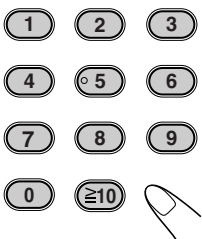

To select a number, see “How to select numbers” on page 7.



- When you play back an MP3/WMA file, you can only select the tracks of the current group.

To display ID3/WMA tag information

While playing MP3/WMA...

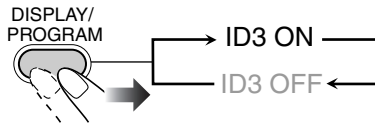

ID3/WMA tag information is shown on the display.

Playing Back Other Equipment

To connect other equipment

By using a stereo mini plug cord (not supplied), you can connect equipment with analog audio output jacks such as a portable audio player.

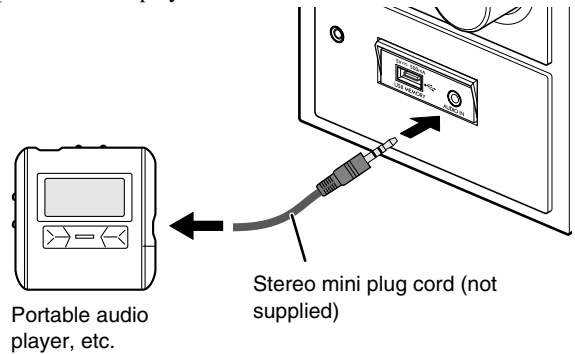

IMPORTANT

- Always set volume to “VOL MIN” when connecting or disconnecting the other equipment.

To select AUDIO IN

From the remote control:



On the main unit:



Daily Operations—Sound & Other Adjustments

Remote control

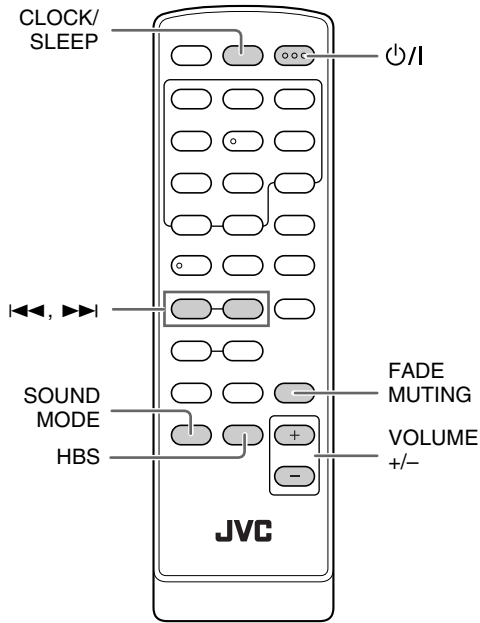

Main unit

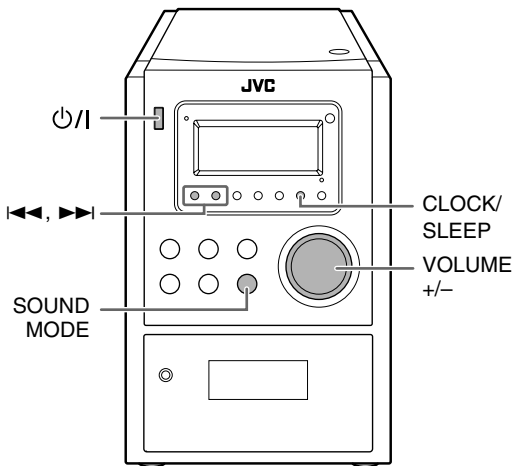

Adjusting the Volume

You can adjust the volume level from level 0 (“VOL MIN”) to level 31 (“VOL MAX”).

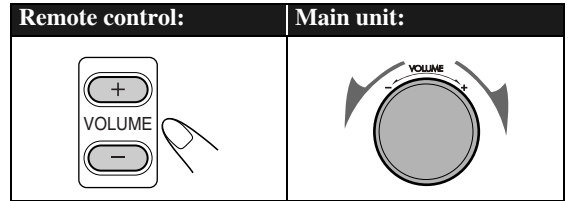

To drop the volume in a moment



To restore the volume, press again, or adjust the volume level.

Adjusting the Sound

To reinforce the bass sound—HBS



You can enjoy powerful bass sound with the Hyper-Bass Sound effect.

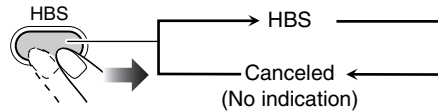

To select Sound Mode

You can select one of 4 SEA (Sound Effect Amplifier) modes.

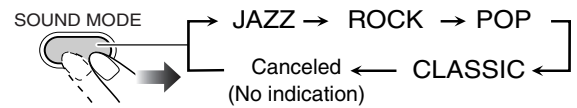

JAZZ	Accented lower frequencies for jazz-type music.
ROCK	Boosts low and high frequencies. (initial setting)
POP	Good for vocal music.
CLASSIC	Good for classical music.
No indication	No sound effects are applied.

Setting the Clock

Set the clock before using the Daily Timer (see page 16).

- You can set the clock only when the System is turned off (on standby).

1 Turn off (standby) the System.

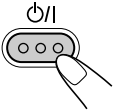

2 Activate the clock setting mode.

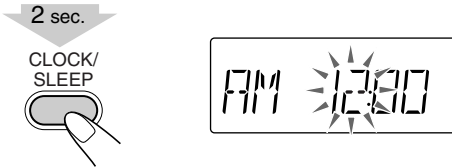

3 Adjust the hour.

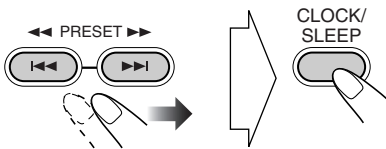

4 Adjust the minute.

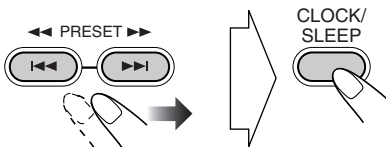

The built-in clock starts working.

To check the current time during play



The time is displayed for a few seconds.

If there is a power failure

The clock loses its settings and "AM 12:00" flashes. You need to set the clock again.

Turning Off the Power Automatically

—Sleep Timer

1 Activate the sleep timer mode.



2 Specify the shut-off time (in minutes).

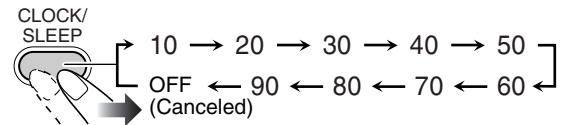

To check the time remaining until the shut-off time



- If you press the button repeatedly, you can change the shut-off time.

Advanced Disc/USB Mass Storage Class Device Operations

Remote control

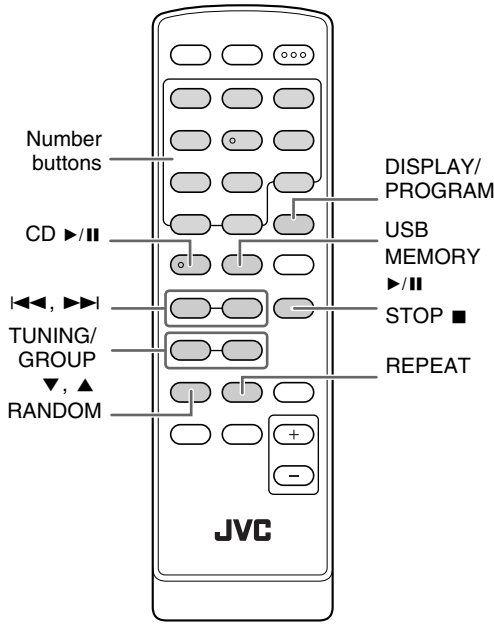

Main unit

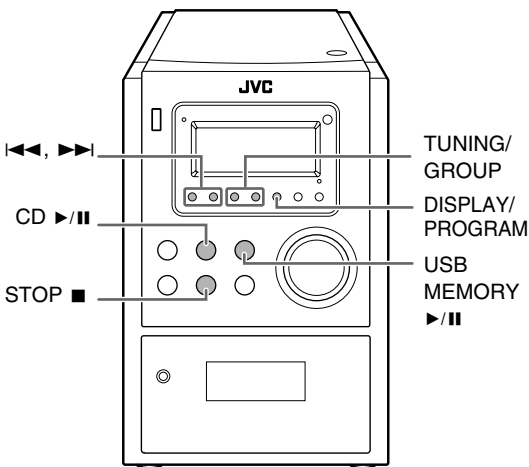

Programming the Playing Order—

Program Play

You can arrange the playing order of the tracks (up to 32) before you start playback.

- You can repeat the programmed tracks by pressing REPEAT.

1 Select the source.

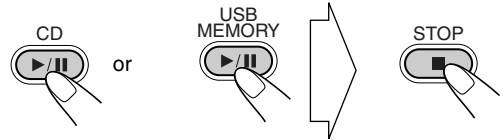

2 Before starting playback, activate Program Play.

For audio CD:



For MP3/WMA:

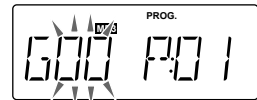

3 Select tracks you want for Program Play.

For audio CD:

Select a track.

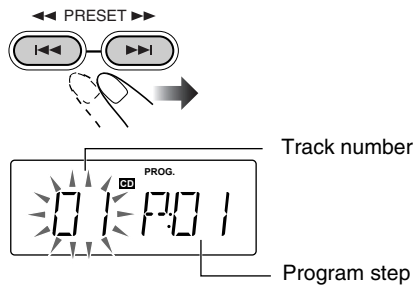

For MP3/WMA:

(1) Select a group.

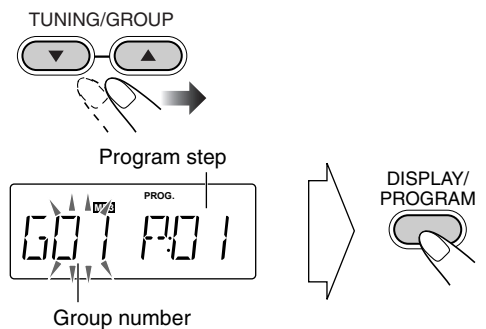

(2) Select a track.

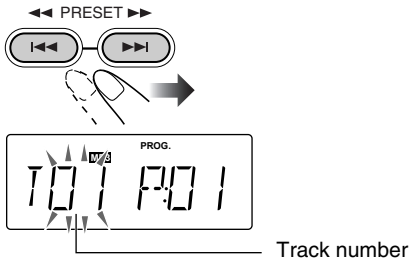

4 Confirm the selection.



Next program step is indicated.

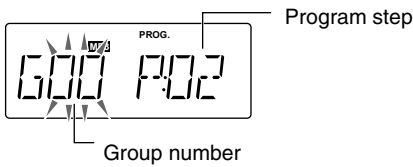

5 Repeat steps 3 and 4 to program the other tracks.

6 Start playback.

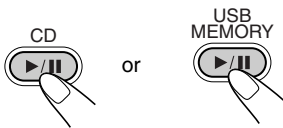

The tracks you have selected are played back in the order you have programmed.

To skip a track:	To pause:	To stop:
	<p>or</p> <p>To release, press again.</p>	

- You cannot select the track with the number buttons during Program Play.

To check the programmed contents

While the PROG. indicator lights up on the display and playback is stopped...

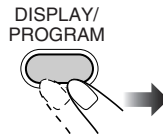

To modify the program

While the PROG. indicator lights up on the display and playback is stopped...

Edit:

- 1 Press DISPLAY/PROGRAM repeatedly until the program step you want to edit is displayed.
- 2 Perform the steps 3 and 4 on pages 13 and 14.

To add step in the program:

- 1 Press DISPLAY/PROGRAM repeatedly until "00" is displayed.
- 2 Perform the steps 3 and 4 on pages 13 and 14.

To erase entire program:



The PROG. indicator goes off.

Program contents are also erased in the following cases:

- When you open the CD door while the source is disc.
- When you disconnect the USB mass storage class device while the source is USB mass storage class device.
- When you start Random Play.
- When you change the source.
- When you turn off the System.



Playing at Random—Random Play

You can play back all the tracks at random.

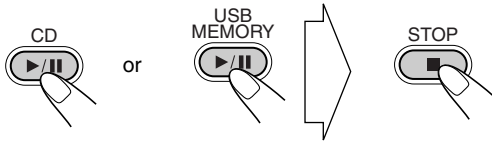

1 Select the source.



2 Start Random Play.

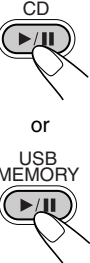

Playback starts in the random order.
Random Play ends when all tracks are played.

To skip a track:	To pause:	To stop:
	 or  To release, press again.	

- You cannot select the track with the number buttons during Random Play.

To exit from Random Play



- You can also exit from Random Play by pressing STOP ■.

Playing Repeatedly—Repeat Play

You can play back tracks repeatedly.

For audio CD:

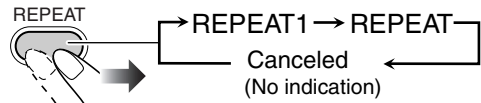

For MP3/WMA:

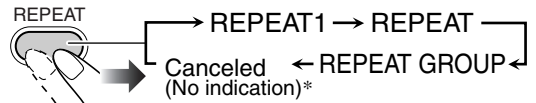

REPEAT1	Repeats the current track.
REPEAT	Repeats all the tracks (or the program during Program Play).
REPEAT GROUP*	Repeats all the tracks in the current group.

* The GROUP indicator lights up on the display when playback is stopped.

Daily Timer Operations

Remote control

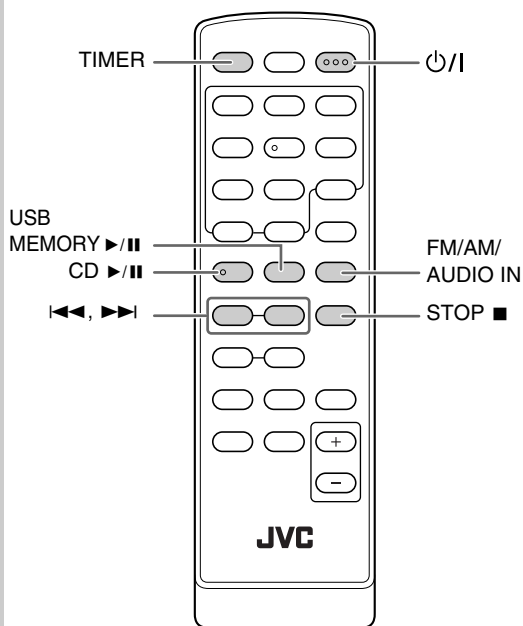

Main unit

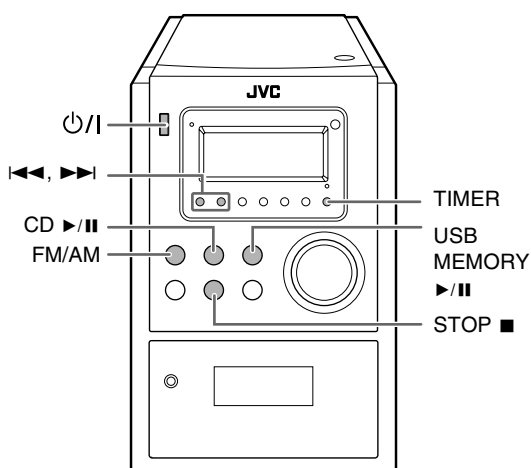

Setting the Daily Timer

Using the Daily Timer, you can wake up with music, etc.

- Set the clock before setting the Daily Timer. (See page 12.)
- To exit from the timer setting, press STOP ■ as required.

1 Activate the Daily Timer setting.

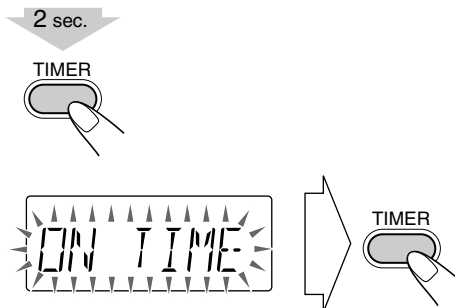

2 Set the On Time.

(1) Set the hour.

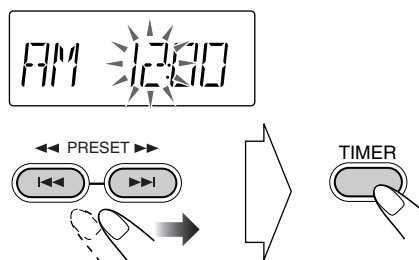

(2) Set the minutes as the hour setting above.

3 Set the Off Time.

(1) Proceed to the Off Time setting.

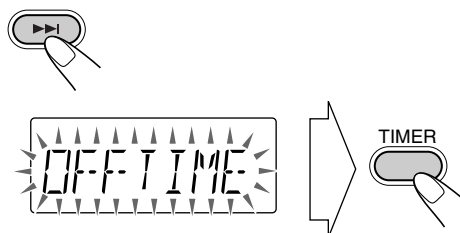

Continued on the next page

(2) Set the hour.

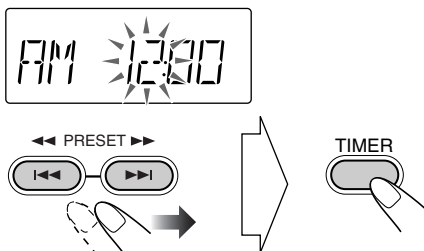

(3) Set the minutes as the hour setting above.

You cannot set On time and Off time on the same time setting.

4 Select the playback source.

(1) Proceed to the playback source setting.

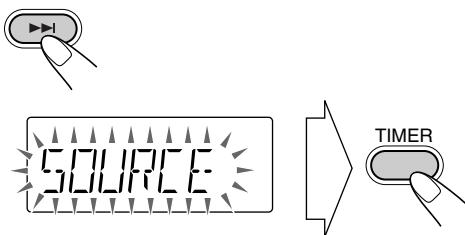

(2) Select the playback source; "CD," "USB," or "TUNER".

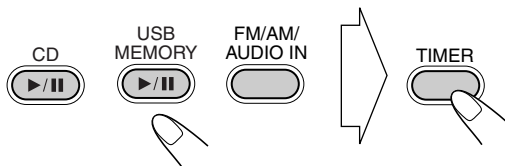

When you select "TUNER"

- 1 Press **◀◀/▶▶** to select "AM PRE" or "FM PRE", then press **TIMER**.
- 2 Press **◀◀/▶▶** to select preset number, then press **TIMER**.

5 Activate the Daily Timer.

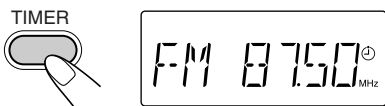

The ⊖ (Timer) indicator on the display and **TIMER** lamp on the main unit light.

6 Turn off the System.

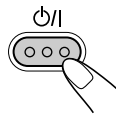

To deactivate the Daily Timer

When the System is turned on...

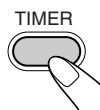

The ⊖ (Timer) indicator on the display and the **TIMER** lamp on the main unit go off.



- When both the Daily Timer and the Sleep Timer are activated, the System is turned off at the earlier off-time.

How the Daily Timer works

Once the Daily Timer is set, the ⊖ (Timer) indicator lights on the display and the **TIMER** lamp on the main unit lights red. The Daily Timer is activated at the same time everyday until the timer is turned off manually.

When the on-time comes

The System turns on, tunes in to the specified station or starts playing the specified source.

- The sound level is gradually turned up until the last time you set. (Maximum Vol.16)
- While the Daily Timer is working, the ⊖ (Timer) indicator flashes on the display.
- Without canceling the Daily Timer, you can change the source or adjust the volume after the Daily Timer starts playback.

When the off-time comes

The System stops playback and turns off (standby).

- The Daily Timer setting remains in memory until you change it.

Additional Information

Learning More about This System

Daily Operations—Playback (see pages 7 to 10)

Listening to the Radio:

- If you store a new station into an occupied preset number, the previously stored station in that number will be erased.
- When you unplug the AC power cord or if a power failure occurs, the preset stations will be erased in a few days. If this happens, preset the stations again.

Playable Media and Files:

- This System cannot play “packet write” discs.
- For MP3/WMA playback...
 - MP3/WMA discs are required a longer readout time than regular CDs. (It depends on the complexity of the group/file configuration.)
 - Some MP3/WMA files cannot be played back and will be skipped. This results from their recording processes and conditions.
 - When making MP3/WMA discs, use ISO 9660 Level 1 or Level 2 for the disc format.
 - This System can play back MP3/WMA files with the extension code <.mp3/.wma> (regardless of the letter case—upper/lower).
 - Some characters or symbols will not be shown correctly on the display.
The maximum character number shown on the display is 32 (without the extension code) for files, and 30 for ID3 tag.
 - It is recommended that you make each MP3/WMA file at a sampling rate of 44.1 kHz and at bit rate of 128 kbps.
 - This System can recognize a total of 999 tracks and 500 groups. Those exceeding the maximum number cannot be recognized.
 - If a folder does not include MP3/WMA tracks, they are ignored.
 - Playback order of MP3/WMA tracks may be different from the one you have intended while recording. If a folder does not include MP3/WMA tracks, they are ignored.
- For playback of files in the USB mass storage class device...
 - You cannot send any data to your USB mass storage class device from this System.
 - Connect one USB mass storage class device directly to the System at a time. Do not use a USB hub.
 - Coded or encrypted tracks in a special method cannot be played on the System.
 - The USB mass storage class device’s battery is charged while the System is turned on.
 - This System cannot recognize a USB mass storage class device whose rating exceeds 5 V/500 mA.
 - This System is compatible with the USB 2.0 Full-Speed.
 - You cannot play back a file larger than 2 GB.
 - When playing a file which has a large transfer rate, sounds may be dropped during playback.
 - Some USB mass storage class devices may not be recognized or may not work properly.
 - The compatible format is FAT16/FAT32.
 - JVC bears no responsibility for any loss of data in the USB mass storage class device while using this System.

MP3/WMA groups/tracks configuration

This System plays back MP3/WMA tracks as follows. The play order in the figure is for MP3/WMA tracks on a disc.

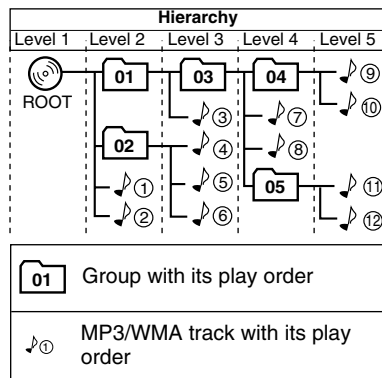

- MP3/WMA tracks in a USB mass storage class device may be played back differently.

Playing Back Other Equipment

- If the audio output on the other equipment is not stereo mini plug type, use a plug adapter to convert the stereo mini plug to the corresponding plug of the audio output. Refer to the manuals supplied with the other equipment.

Daily Operations—Sound & Other Adjustments (see pages 11 and 12)

Adjusting the Volume:

- Be sure to turn down the volume before connecting or putting the headphones.

Adjusting the Sound:

- This function also affects the sound through the headphones.

Setting the Clock:

- “AM 12:00” flashes on the display until you set the clock.
- The clock may gain or lose 1 to 2 minutes per month. If this happens, set the clock again.

Advanced Disc/USB Mass Storage Class Device Operations (see pages 13 to 15)

Programming the Playing Order—Program Play:

- If you try to program a 33rd track, “PROGFUL” appears on the display.
- While programming steps...
Your entry will be ignored if you have tried to program an item number that does not exist on the disc (for example, selecting track 14 on a disc that only has 12 tracks).

Daily Timer Operations (see pages 16 and 17)

- When you unplug the AC power cord or if a power failure occurs, the timer will be canceled. You need to set the clock first, then the timer again.

Troubleshooting

If you are having a problem with your System, check this list for a possible solution before calling for service.

General:

Adjustments or settings are suddenly canceled before you finish.

- ⇒ There is a time limit. Repeat the procedure again.

Operations are disabled.

- ⇒ The built-in microprocessor may malfunction due to external electrical interference. Unplug the AC power cord and then plug it back in.

Unable to operate the System from the remote control.

- ⇒ The path between the remote control and the remote sensor on the System is blocked.
- ⇒ Point it at the remote sensor on the front panel.
- ⇒ Move closer to the System.
- ⇒ The batteries are exhausted.

No sound is heard from the speakers.

- ⇒ Speaker connections are incorrect or loose (see page 5).
- ⇒ Headphones are connected (see page 7).

Radio Operations:

Hard to listen to broadcasts because of noise.

- ⇒ Antenna connections are incorrect or loose.
- ⇒ The AM loop antenna is too close to the System.
- ⇒ The FM antenna is not properly extended or positioned.

Disc Operations:

The disc does not play.

⇒ The disc is placed upside down. Place the disc with the label side up.

The disc sound is discontinuous.

⇒ The disc is scratched or dirty.

Daily Timer Operations:

The Daily Timer does not work.

⇒ The System has been turned on when the on-time comes. The Daily Timer starts working only when the System is turned off.

⇒ There might have been a power failure. Set the clock first, then the timer again.

“INVALID” appears on the display.

⇒ On-time and off-time are set to the same time. Set the different time for on-time and off-time.

Maintenance

To get the best performance of the System, keep your discs, and mechanism clean.

Handling discs

- When removing the disc from its case, hold it at the edge while pressing the center hole lightly.
- Do not touch the shiny surface of the disc, or bend the disc.
- Put the disc back in its case after use to prevent warping.
- Be careful not to scratch the surface of the disc.
- Avoid exposure to direct sunlight, temperature extremes, and moisture.

To clean the disc:

Wipe the disc with a soft cloth in a straight line from center to edge.

Handling USB mass storage class devices

- Do not touch the USB connector.
- Be careful not to damage the USB connector.
- Put the USB connector in the cover or slide in the USB unit after use to prevent breaking.

Cleaning the System

- Stains should be wiped off with a soft cloth. If the System is heavily stained, wipe it with a cloth soaked in water-diluted neutral detergent and wrung well, then wipe clean with a dry cloth.
- Since the System may deteriorate in quality, it become damaged or get its paint peeled off, be careful about the following:
 - DO NOT wipe it with a hard cloth.
 - DO NOT wipe it strongly.
 - DO NOT wipe it with thinner or benzine.
 - DO NOT apply any volatile substance such as insecticides to it.
 - DO NOT allow any rubber or plastic to remain in contact for a long time.

Specifications

Amplifier section

Output Power: **8 W per channel, min. RMS, driven into 4 Ω at 1 kHz with no more than 10% total harmonic distortion.**

Speakers/Impedance: 4 Ω – 8 Ω

Terminals

AUDIO IN:

Input sensitivity/Impedance:
250 mV/50 k Ω

USB MEMORY:

USB specification: Compatible with USB 2.0 Full-Speed

Compatible device: Mass storage class

Compatible system: FAT16, FAT32

Output power: DC 5 V \approx 500 mA

Tuner section

FM tuning range: 87.5 MHz – 108.0 MHz

AM tuning range: 530 kHz – 1 710 kHz

CD player section

Dynamic range: 60 dB

Signal-to-noise ratio: 60 dB

Wow and flutter: Immeasurable

General

Power requirement: AC 120 V \sim , 60 Hz

Power consumption: 35 W (at operation)
1.1 W (on standby)

Dimensions (approx.): 144 mm \times 218 mm \times 256 mm
(5-11/16 inches \times 8-5/8 inches \times 10-1/8 inches)
(W \times H \times D)

Mass (approx.): 2.3 kg (5.1 lbs)

Speakers

Type: 1-way Bass reflex

Speaker units: 10 cm (3-15/16 inches) cone \times 1
4 Ω

Impedance: 4 Ω

Dimensions (approx.): 136 mm \times 212 mm \times 172 mm
(5-3/8 inches \times 8-3/8 inches \times 6-
13/16 inches)
(W \times H \times D)

Mass (approx.): 1.2 kg (2.7 lbs) each

Supplied Accessories

See page 3.

Design and specifications are subject to change without notice.

Parts Index

Refer to the pages to see how to use the buttons and controls.

Remote control

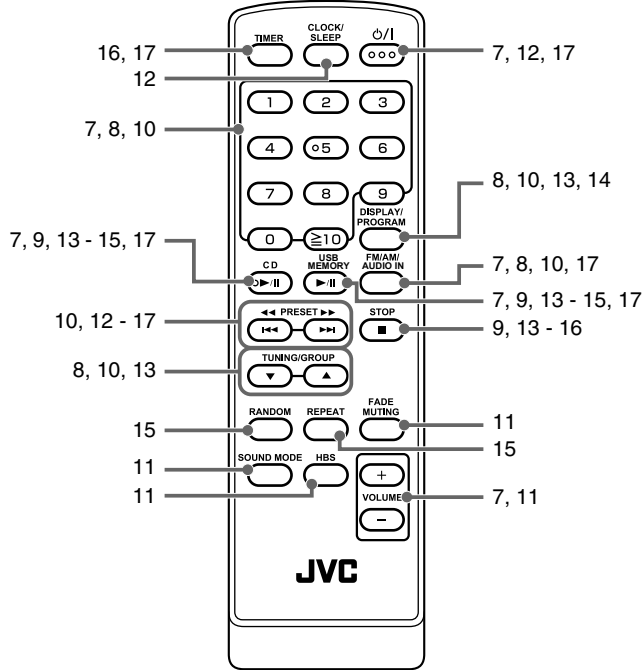

Main unit

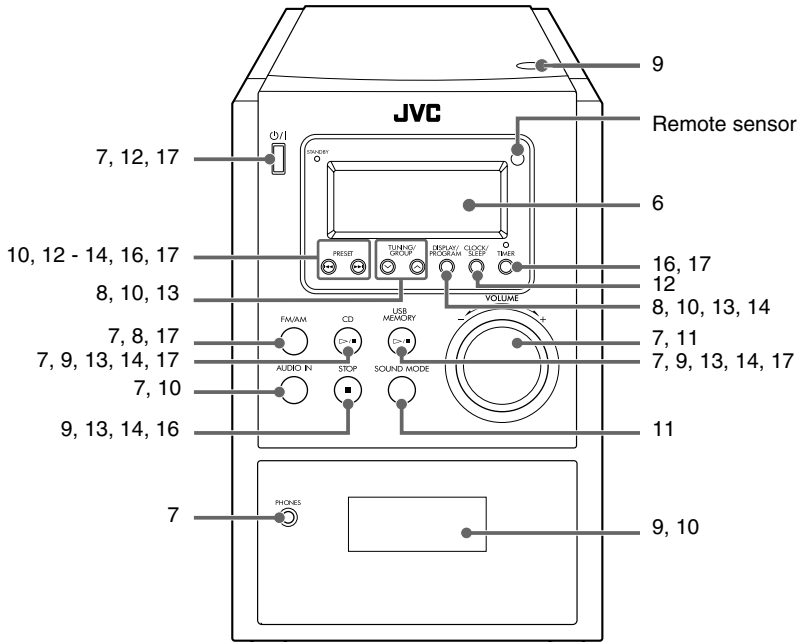

TO OUR VALUED CUSTOMER ———

THANK YOU FOR PURCHASING THIS JVC PRODUCT.
WE WANT TO HELP YOU ACHIEVE A PERFECT EXPERIENCE.

**NEED HELP ON HOW TO HOOK UP?
NEED ASSISTANCE ON HOW TO OPERATE?
NEED TO LOCATE A JVC SERVICE CENTER?
LIKE TO PURCHASE ACCESSORIES?**

JVC[®] IS HERE TO HELP!
TOLL FREE: 1(800)252-5722
<http://www.jvc.com>

Remember to retain your Bill of Sale for Warranty Service.

————— **Do not attempt to service the product yourself** —————

Caution

To prevent electrical shock, do not open the cabinet.
There are no user serviceable parts inside.
Please refer to qualified service personnel for repairs.

BT-51018-5
(0306)



LIMITED WARRANTY

1-1 USA ONLY

ONLY FOR PRODUCT PURCHASED IN U.S.A.

JVC Americas Corp. (JVC) warrants this product and all parts thereof, except as set forth below ONLY TO THE ORIGINAL RETAIL PURCHASER to be FREE FROM DEFECTIVE MATERIALS AND WORKMANSHIP from the date of original purchase for the period shown below. ("The Warranty Period")

PARTS	1 YR	LABOR	1 YR
-------	-------------	-------	-------------

THIS LIMITED WARRANTY IS VALID ONLY IN THE FIFTY (50) UNITED STATES, THE DISTRICT OF COLUMBIA AND IN THE COMMONWEALTH OF PUERTO RICO.

WHAT WE WILL DO:

If this product is found to be defective within the warranty period, JVC will repair or replace defective parts with new or rebuilt equivalents at no charge to the original owner. Such repair and replacement services shall be rendered by JVC during normal business hours at JVC authorized service centers. Parts used for replacement are warranted only for the remainder of the Warranty Period. All products may be brought to a JVC authorized service center on a carry-in basis. Color televisions with a screen size of 27" or greater qualify for in-home service. In such cases, a technician will come to your home and either repair the TV there or remove and return it if it cannot be repaired in your home.

WHAT YOU MUST DO FOR WARRANTY SERVICE:

Please do not return your product to the retailer
Instead, return your product to the JVC authorized service center nearest you. If shipping the product to the service center, please be sure to package it carefully, preferably in the original packaging, and include a brief description of the problem(s). Please call 1-800-252-5722 to locate the nearest JVC authorized service center. Service locations can also be obtained from our website <http://www.jvc.com>. If your product qualifies for in-home service, the service representative will require clear access to the product.

If you have any questions concerning your JVC Product, please contact our Customer Care Center at 800-252-5722

WHAT IS NOT COVERED:

- This limited warranty provided by JVC does not cover:
1. Products which have been subject to abuse, accident, alteration, modification, tampering, negligence, misuse, faulty installation, lack of reasonable care, or if repaired or serviced by anyone other than a service facility authorized by JVC to render such service, or if affixed to any attachment not provided with the products, or if the model or serial number has been altered, tampered with, defaced or removed;
 2. Initial installation, installation and removal from cabinets or mounting systems.
 3. Operational adjustments covered in the Owner's Manual, normal maintenance, video and audio head cleaning;
 4. Damage that occurs in shipment, due to act of God, and cosmetic damage;
 5. Signal reception problems and failures due to line power surge;
 6. User Removal Memory Devices/Video Pick-up Tubes/CCD Image Sensors are covered for 90 days from the date of purchase;
 7. Accessories;
 8. Batteries (except that Rechargeable Batteries are covered for 90 days from the date of purchase);
 9. Products used for commercial purposes, including, but not limited to rental.
 10. Loss of data resultant from malfunction of hard drive or other data storage device;

There are no express warranties except as listed above.

THE DURATION OF ANY IMPLIED WARRANTIES, INCLUDING THE IMPLIED WARRANTY OF MERCHANTABILITY, IS LIMITED TO THE DURATION OF THE EXPRESS WARRANTY HEREIN.

JVC SHALL NOT BE LIABLE FOR ANY LOSS OF USE OF THE PRODUCT, INCONVENIENCE, OR ANY OTHER DAMAGES, WHETHER DIRECT, INCIDENTAL OR CONSEQUENTIAL (INCLUDING, WITHOUT LIMITATION, DAMAGE TO TAPES, RECORDS OR DISCS) RESULTING FROM THE USE OF THIS PRODUCT, OR ARISING OUT OF ANY BREACH OF THIS WARRANTY. ALL EXPRESS AND IMPLIED WARRANTIES, INCLUDING THE WARRANTIES OF MERCHANTABILITY AND FITNESS FOR PARTICULAR PURPOSE, ARE LIMITED TO THE WARRANTY PERIOD SET FORTH ABOVE.

Some states do not allow the exclusion of incidental or consequential damages or limitations on how long an implied warranty lasts, so these limitations or exclusions may not apply to you. This warranty gives you specific legal rights and you may also have other rights which vary from state to state.

JVC AMERICAS CORP.
1700 Valley Road, Wayne, New Jersey 07470
<http://www.jvc.com>

REFURBISHED PRODUCTS CARRY A SEPARATE WARRANTY, THIS WARRANTY DOES NOT APPLY. FOR DETAIL OF REFURBISHED PRODUCT WARRANTY, PLEASE REFER TO THE REFURBISHED PRODUCT WARRANTY INFORMATION PACKAGED WITH EACH REFURBISHED PRODUCT.

For customer use:

Enter below the Model No. and Serial No. which is located either on the rear, bottom or side of the cabinet. Retain this information for future reference.

Model No. : _____ Serial No. : _____

Purchase date : _____ Name of dealer : _____

JVC



EN