



marantz®

Network Receiver **M-CR511**

You can print more than one page of a PDF onto a single sheet of paper.

Owner's Manual

[Front/Top panel](#)[Rear panel](#)[Remote control unit](#)[Index](#)

| | |
|--|----------|
| Accessories | 6 |
| Inserting the batteries | 7 |
| Operating range of the remote control unit | 7 |
| Features | 8 |
| Multiple music formats are supported, all in a compact form factor | 8 |
| Easy operation | 8 |
| Part names and functions | 9 |
| Front/Top panel | 9 |
| Rear panel | 12 |
| Remote control unit | 14 |

Connections

| | |
|--|-----------|
| Speaker connection | 18 |
| Connecting the speaker cables | 18 |
| Connecting the subwoofer | 19 |
| Connecting speakers | 19 |
| Connecting a digital device | 20 |
| Connecting an analog device | 21 |
| Connecting an iPod or USB memory device to the USB port | 22 |
| Connecting to a home network (LAN) | 24 |
| Wired LAN | 24 |
| Wireless LAN | 25 |
| Connecting the power cord | 27 |



Playback

| | |
|---|-----------|
| Basic operation | 29 |
| Turning the power on | 29 |
| Selecting the input source | 29 |
| Adjusting the volume | 30 |
| Turning off the sound temporarily | 30 |
| Listening to Internet Radio | 31 |
| Listening to Internet Radio | 32 |
| Playing the last played Internet Radio station | 33 |
| Using vTuner to add Internet Radio stations to favorites | 34 |
| Playing back files stored on a PC and NAS | 35 |
| Applying media sharing settings | 36 |
| Playing back files stored on a PC and NAS | 37 |
| Favorite function | 39 |
| Registering stations or files to the favorites list | 40 |
| Calling stations or files from the favorites list | 40 |
| To switch between registered stations and files during playback | 40 |
| Deleting stations or files from the favorite list | 40 |
| Playing an iPod | 41 |
| Listening to music on an iPod | 42 |
| Setting operation mode (“On-Display” mode) | 43 |
| Charging the iPod/iPhone | 44 |
| Playing a USB memory device | 45 |
| Playing files stored on USB memory devices | 46 |

| | |
|---|-----------|
| Listening to music on a Bluetooth device | 47 |
| Playing music from Bluetooth device | 48 |
| Pairing with other Bluetooth devices | 50 |
| Reconnecting to this unit from a Bluetooth device | 51 |
| Connecting a Bluetooth device with the NFC function via NFC | 51 |
| Listening to DIGITAL IN | 53 |
| Listening to ANALOG IN | 53 |
| AirPlay function | 54 |
| Playing songs from your iPhone, iPod touch or iPad | 55 |
| Playing iTunes music with this unit | 55 |
| Selecting multiple speakers (devices) | 56 |
| Spotify Connect function | 57 |
| Playing Spotify music with this unit | 57 |
| Remote play function | 58 |
| Settings required for each device | 59 |
| Web control function | 61 |
| Controlling the unit from a web control | 61 |
| Convenience functions | 67 |
| Adjusting the tone | 68 |
| Sleep timer function | 69 |
| Checking the current time | 69 |
| Switching the display’s brightness | 70 |



Settings

| | |
|-----------------------------|-----------|
| Menu map | 71 |
| Menu operation | 74 |
| Inputting characters | 75 |
| Using the number buttons | 75 |
| Using the cursor buttons | 76 |
| General | 77 |
| Alarm | 77 |
| Clock | 78 |
| Clock Mode | 78 |
| Volume Limit | 79 |
| Speaker Response | 79 |
| Language | 80 |
| Auto-Standby | 80 |
| Usage Data | 80 |
| Firmware | 81 |
| Reset | 83 |

| | |
|---------------------|-----------|
| Network | 84 |
| Network Information | 84 |
| Network Control | 84 |
| Friendly Name | 85 |
| Wi-Fi | 85 |
| Bluetooth | 85 |
| Settings | 86 |



Tips

| | |
|-----------------|----|
| Tips | 93 |
| Troubleshooting | 95 |

Appendix

| | |
|---|------------|
| Playing back USB memory devices | 107 |
| Playing back Internet Radio | 109 |
| Playing back Bluetooth devices | 109 |
| Bluetooth communications | 109 |
| Playing back files stored on PC or NAS | 110 |
| Last function memory | 111 |
| Explanation of terms | 112 |
| Trademark information | 117 |
| Specifications | 118 |
| Index | 123 |
| License | 125 |







Thank you for purchasing this Marantz product.

To ensure proper operation, please read this owner's manual carefully before using the product.

After reading this manual, be sure to keep it for future reference.

Accessories

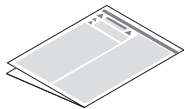
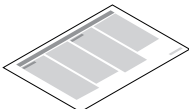
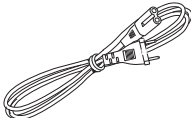
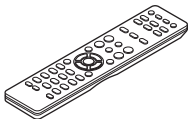
Check that the following parts are supplied with the product.

| | | | | |
|---|---|--|--|---|
|  Quick Setup Guide |  CD-ROM (Owner's Manual) |  Safety Instructions |  Notes on radio |  Power cord |
|  Remote control unit (RC012CR) |  R03/AAA batteries | | | |



Inserting the batteries

- 1 Remove the rear lid in the direction of the arrow and remove it.

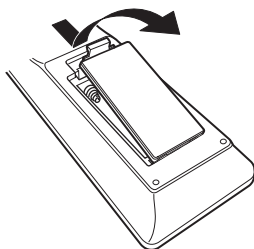

- 2 Insert two batteries correctly into the battery compartment as indicated.

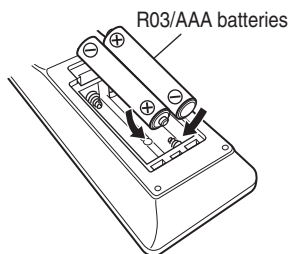

- 3 Put the rear cover back on.

NOTE

- To prevent damage or leakage of battery fluid:
 - Do not use a new battery together with an old one.
 - Do not use two different types of batteries.
- If the battery fluid should leak, carefully wipe the fluid off the inside of the battery compartment and insert new batteries.

Operating range of the remote control unit

Point the remote control unit at the remote sensor when operating it.

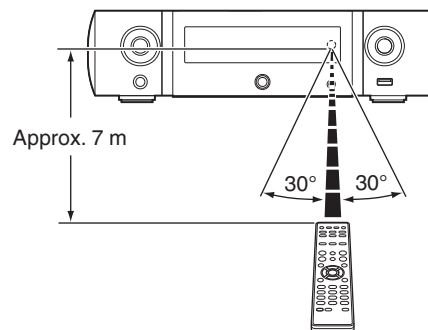

Features

Multiple music formats are supported, all in a compact form factor

- **Supports Internet Radio and music streaming**
Supports AirPlay® (🔗 p. 54)
You can enjoy a wide variety of content, including listening to Internet Radio, playing audio files stored on your PC.
This unit also supports Apple AirPlay which lets you stream your music library from an iPhone®, iPad®, iPod touch® or iTunes®.
- **DLNA (Digital Living Network Alliance) ver. 1.5 support for audio networks**
- **Supports Spotify Connect**
- **Support for High Quality Audio playback**
WAV/FLAC/ALAC (Apple Lossless Audio Codec)/AIFF
- **Support for Gapless playback**
Playback with no gap between music files (for WAV/FLAC/ALAC/AIFF only).
- **Wi-Fi network capability with built-in diversity antenna, and is certified under WMM (Wi-Fi Multi Media) for efficient wireless connectivity**

Easy operation

- **Easy wireless connection is possible by pressing the Wi-Fi CONNECT button (WPS and Wi-Fi Sharing)**
See the separate “Quick Setup Guide”.
- **Wireless connection with Bluetooth devices can be carried out easily**
You can enjoy music simply by connecting wirelessly with your smartphone, tablet, PC, etc.
- **If the Bluetooth device has NFC function, you can connect easily to touch to N mark**
- **iPod auto detect charges your device even after the unit switches to standby mode**
- **“Marantz Hi-Fi Remote” is application software that allows you to perform basic operations with an iPad, iPhone, Android smartphone or Android tablet such as turning the unit ON/OFF, controlling the volume, and switching the source**
* Download the appropriate “Marantz Hi-Fi Remote” for your iOS or Android devices. This unit needs to be connected to your LAN and the iPad, iPhone, Android smartphone, Android tablet or other device needs to be connected to the same network by Wi-Fi (wireless LAN).
- **OLED (Organic Light Emitting Diode) display that can display 3 lines**
- **Auto Standby mode for energy savings**



Part names and functions

Front/Top panel

【Top panel】

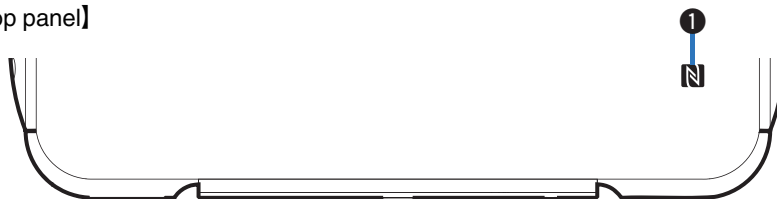

【Front panel】

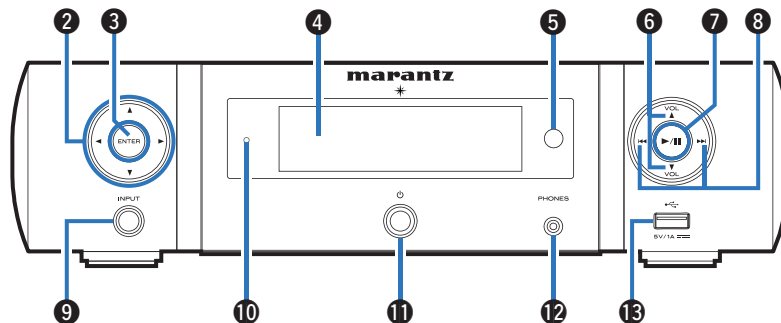

【Top panel】

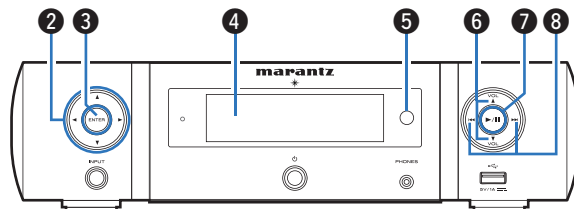

【Front panel】

**1 N mark (N)**

Touch this mark with a Bluetooth device that includes the NFC function when pairing (registering) with it. (☞ p. 51)

2 Cursor buttons (Δ▽◀▶)

These select items.

3 ENTER button

This determines the selection.

4 Display

Various information is displayed here.

5 Remote control sensor

This receives signals from the remote control unit. (☞ p. 7)

6 VOLUME up/down buttons (VOLUME ▲▼)

Adjusts the volume. (☞ p. 30)

7 Play/pause button (▶/||)**8 Reverse-skip / Forward-skip buttons (◀◀, ▶▶)**

【Front panel】

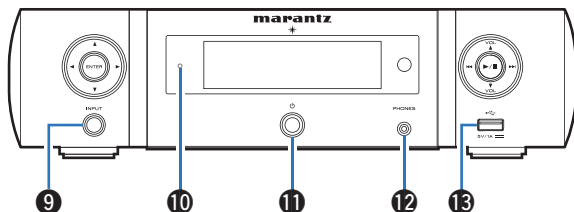
**9 Input source select button (INPUT)**

Selects the input source. (☞ p. 29)

10 Standby indicator

The standby indicator changes as shown below according to the status of the unit.

- Power on : Off
- Normal standby : Off
- iPod charge standby : Red (☞ p. 44)
- Display off : Green (☞ p. 70)
- Alarm standby : Orange (☞ p. 77)
- When "Network Control" is set to "On" : Red (☞ p. 84)

11 Power operation button (⏻)

Turns power to this unit on and off (standby). (☞ p. 29)



- When "Clock Mode" is turned on, this button switches between normal mode and Clock mode. (☞ p. 78)

12 Headphones jack (PHONES)

Used to connect headphones.

When the headphones are plugged into this jack, audio will no longer be output from the speaker terminals and SW OUT connector.

NOTE

- To prevent hearing loss, do not raise the volume level excessively when using headphones.

13 USB port (🔌, Front)

Used to connect iPod or USB memory devices. (☞ p. 22)



Rear panel

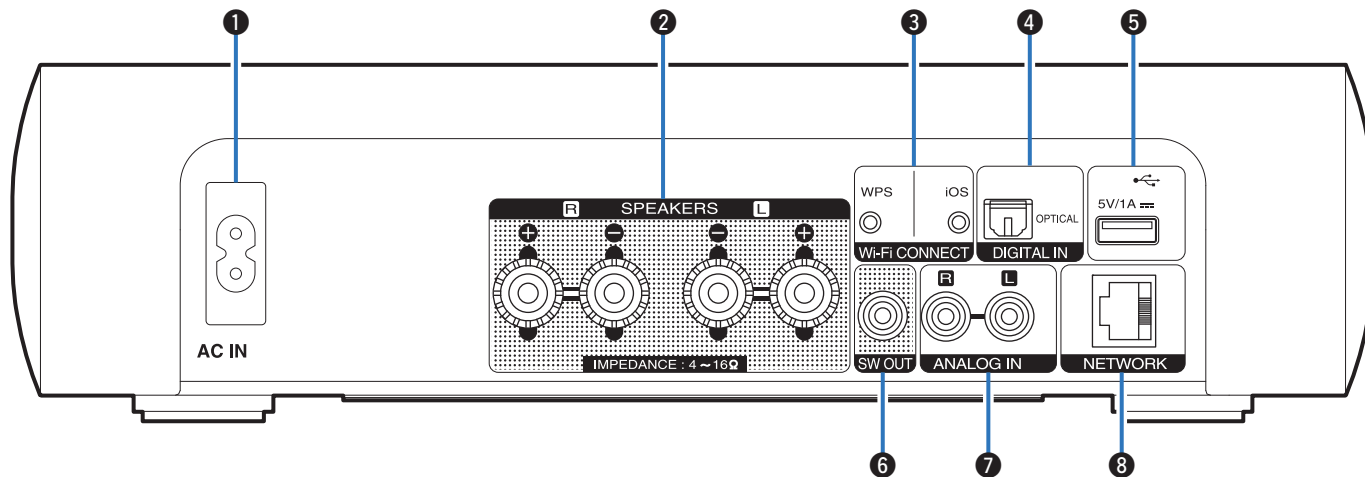

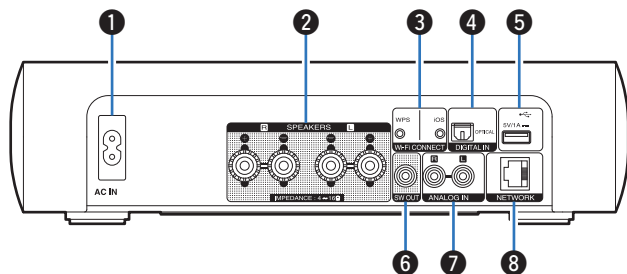

1 AC inlet (AC IN)

Used to connect the supplied power cord. (👉 p. 27)

2 Speaker terminals (SPEAKERS)

Used to connect speakers. (👉 p. 18)

3 Wi-Fi CONNECT buttons (iOS/WPS)

Used to connect to the wireless LAN.
(See the separate “Quick Setup Guide”.)

4 DIGITAL IN connector

Used to connect devices equipped with digital audio connectors.
(👉 p. 20)

5 USB port (🔌, Rear)

Used to connect iPod or USB memory devices. (👉 p. 22)

6 SW OUT connector

Used to connect a subwoofer with a built-in amplifier. (👉 p. 19)

7 ANALOG IN connectors

Used to connect devices equipped with analog audio connectors.
(👉 p. 21)

8 NETWORK connector

Used to connect this unit to the network. (👉 p. 24)



Remote control unit

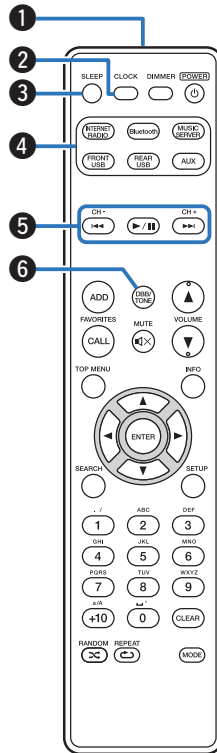

1 Remote control signal transmitter

This transmits signals from the remote control unit. (☞ p. 7)

2 CLOCK button

The current time appear on the unit. (☞ p. 69)

3 SLEEP button

This sets the sleep timer. (☞ p. 69)

4 Input source select buttons

These select the input source. (☞ p. 29)

5 System buttons

These perform playback related operations.

Channel buttons (CH +, -)

These operate the Favorite function. (☞ p. 39)

6 DBB/TONE button

Adjusting the tone. (☞ p. 68)



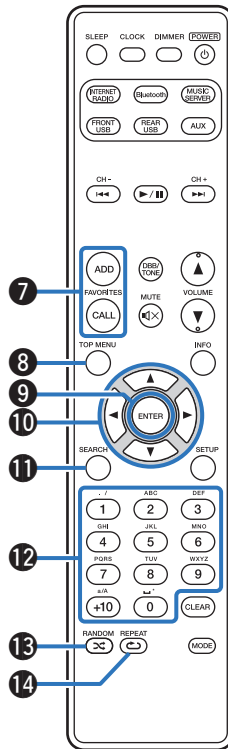

7 FAVORITES ADD / CALL buttons

- To add radio stations or files to the favorite list, press ADD button. (☞ p. 40)
- To call up a radio station or file registered in the favorite list, press CALL button. (☞ p. 40)

8 TOP MENU button

To back to the top of the menu. (☞ p. 74)

9 ENTER button

This determines the selection.

10 Cursor buttons (Δ∇◀▶)

These select items.

11 SEARCH button

This displays the search menu.

12 Number buttons (0 – 9, +10)

These enter letters or numbers into the unit.

13 RANDOM button (⌘)

Switches the random playback.

14 REPEAT button (↺)

Switches to the repeat playback.

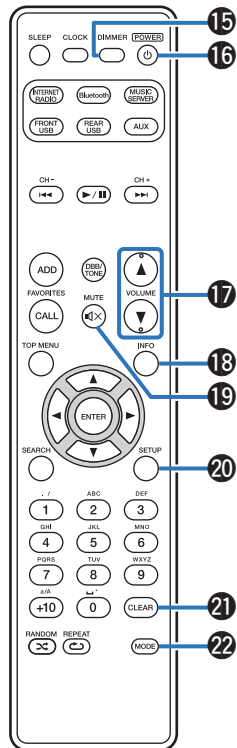

**15 DIMMER button**

Adjust the display brightness of this unit. (☞ p. 70)

16 POWER button (⏻)

This turns the power on/standby. (☞ p. 29)

17 VOLUME buttons (▲▼)

These adjust the volume level. (☞ p. 30)

18 Information button (INFO)

This switches display items such as the artist name and album name in the playback screen.

19 MUTE button (⏻)

This mutes the output audio. (☞ p. 30)

20 SETUP button

The setting menu is displayed on the display. (☞ p. 74)

21 CLEAR button

This cancels the settings.

22 MODE button

This switches the operation mode. (☞ p. 43)



■ Contents





| | |
|---|----|
| Speaker connection | 18 |
| Connecting a digital device | 20 |
| Connecting an analog device | 21 |
| Connecting an iPod or USB memory device to the USB port | 22 |
| Connecting to a home network (LAN) | 24 |
| Connecting the power cord | 27 |

NOTE

- Do not plug in the power cord until all connections have been completed.
- Do not bundle power cords with connection cables. Doing so can result in noise.

■ Cables used for connections

Provide necessary cables according to the devices you want to connect.

| | |
|-----------------|---|
| Speaker cable |  |
| Subwoofer cable |  |
| Optical cable |  |
| Audio cable |  |
| LAN cable |  |



Speaker connection

Here we connect the speakers in the room to this unit.

This section explains how to connect them using typical examples.

NOTE

- Disconnect this unit's power plug from the power outlet before connecting the speakers. Also, turn off the subwoofer.
- Connect so that the speaker cable core wires do not protrude from the speaker terminal. The protection circuit may be activated if the core wires touch the rear panel or if the + and - sides touch each other. ("Protection circuit" (ⓘ p. 116))
- Never touch the speaker terminals while the power cord is connected. Doing so could result in electric shock.
- Use speakers with an impedance of 4 – 16 Ω/ohms.

Connecting the speaker cables

Connect the speaker cable to the + speaker terminal (red) and the - speaker terminal (black).

- 1 Peel off about 10 mm of sheathing from the tip of the speaker cable, then twist the core wire tightly.**



- 2 Turn the speaker terminal counterclockwise to loosen it.**



- 3 Insert the speaker cable's core wire to the hilt into the speaker terminal.**



- 4 Turn the speaker terminal clockwise to tighten it.**



Connecting the subwoofer

Use a subwoofer cable to connect the subwoofer.

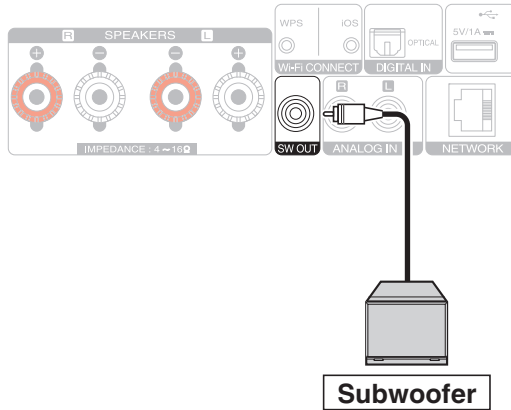

Connecting speakers

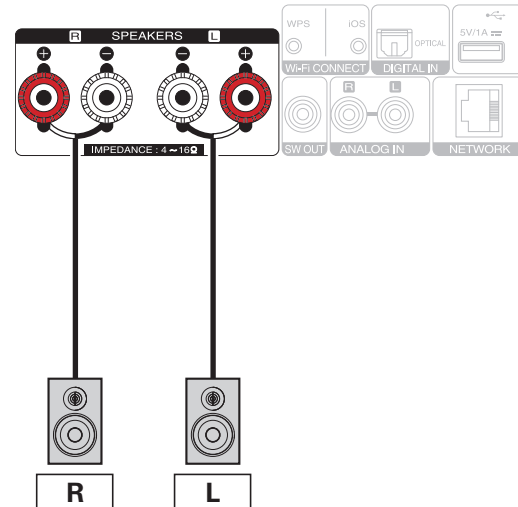

Connecting a digital device

You can connect this unit to devices with digital audio output (TV, digital gear, etc.).

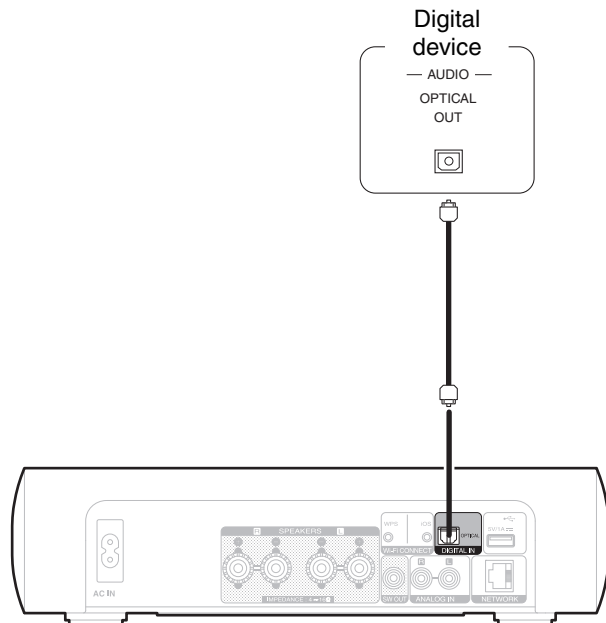

NOTE

- Linear PCM signals with a sampling frequency of 32 kHz, 44.1 kHz, 48 kHz, 88.2 kHz, 96 kHz, 176.4 kHz, or 192 kHz can be input into this device.
- Do not input signals other than linear PCM signals, such as Dolby digital, DTS, AAC etc. into this device. Doing so may cause noise, which may cause damage to the speakers.



Connecting an analog device

You can connect this unit to various devices with analog audio output.

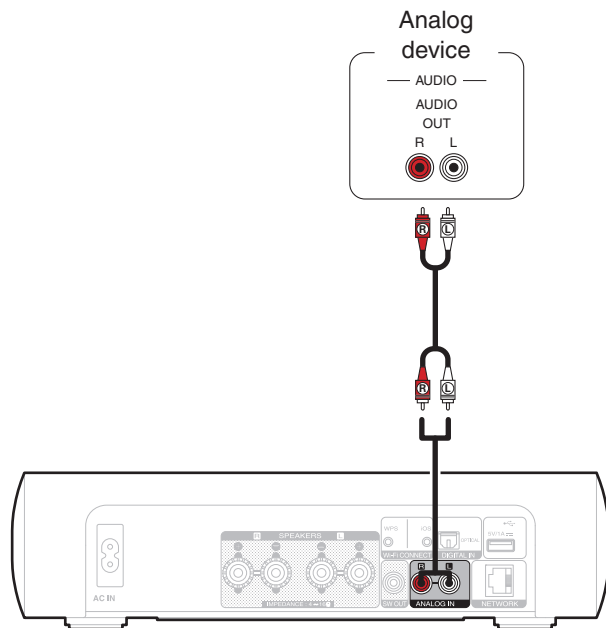

Connecting an iPod or USB memory device to the USB port

- To connect an iPod/iPhone to this unit, use the USB adapter cable that was supplied with the iPod/iPhone.
- For operating instructions, see “Playing an iPod” (🔗 p. 41) or “Playing files stored on USB memory devices” (🔗 p. 46).

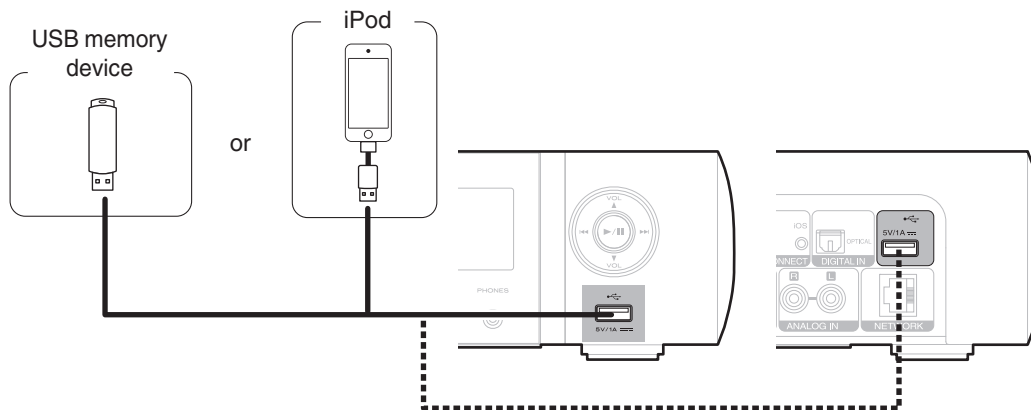

- Marantz does not guarantee that all USB memory devices will operate or receive power. When using a portable USB hard disk drive (HDD) which came with an AC adapter, use that device's supplied AC adapter.

NOTE

- USB memory devices will not work via a USB hub.
- It is not possible to use this unit by connecting the unit's USB port to a PC via a USB cable.
- Do not use an extension cable when connecting a USB memory device. This may cause radio interference with other devices.



■ Supported iPod/iPhone models

• iPod classic



iPod classic
80GB



iPod classic
160GB (2007)



iPod classic
160GB (2009)

• iPod nano



iPod nano
3rd generation
(video)
4GB 8GB



iPod nano
4th generation (video)
8GB 16GB



iPod nano
5th generation (video camera)
8GB 16GB



iPod nano
6th generation
8GB 16GB



iPod nano
7th generation
16GB

• iPod touch



iPod touch
2nd generation
8GB 16GB 32GB



iPod touch
3rd generation
32GB 64GB



iPod touch
4th generation
8GB 16GB 32GB 64GB



iPod touch
5th generation
16GB 32GB 64GB

• iPhone



iPhone 3G
8GB 16GB



iPhone 3GS
16GB 32GB



iPhone 4
8GB 16GB 32GB



iPhone 4S
16GB 32GB 64GB



iPhone 5
iPhone 5c iPhone 5s
16GB 32GB 64GB



Connecting to a home network (LAN)

You can connect this unit to your home network (LAN) to perform various types of playbacks and operations as follows.

- Playback of network audio such as Internet Radio and from your music server(s)
- Playback of music content from online streaming services
- Using the Apple AirPlay function
- Operation on this unit via the network
- Firmware Update

For connections to the Internet, contact an ISP (Internet Service Provider) or a computer shop.

Wired LAN

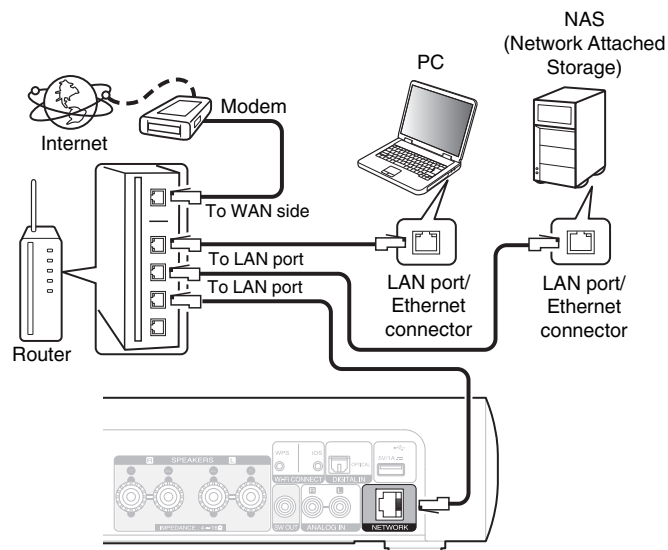

Wireless LAN

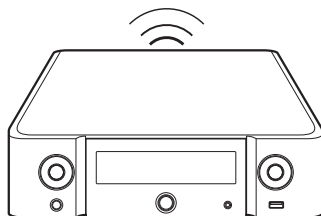
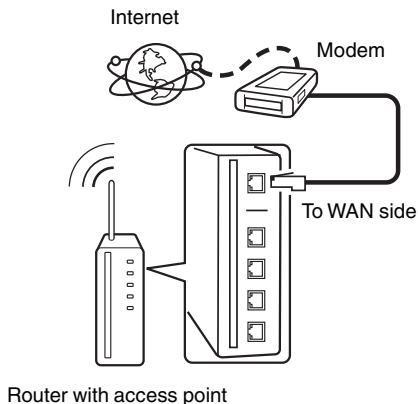

- With this unit, it is possible to use the DHCP and Auto IP functions to make the network settings automatically.
- When using this unit with the broadband router's DHCP function enabled, this unit automatically performs the IP address setting and other settings. When using this unit connected to a network with no DHCP function, make the settings for the IP address, etc., at "Network". (☞ p. 84)
- When using this unit, we recommend you use a router equipped with the following functions:
 - Built-in DHCP server
This function automatically assigns IP addresses on the LAN.
 - Built-in 100BASE-TX switch
When connecting multiple devices, we recommend a switching hub with a speed of 100 Mbps or greater.
- Use only a shielded STP or ScTP LAN cable which is easily available at electronics stores. (CAT-5 or greater recommended)
- The normal shielded-type LAN cable is recommended. If a flat-type cable or unshielded-type cable is used, other devices could be affected by noise.
- When using a WPS (Wi-Fi Protected Setup) compatible router, you can connect easily to Wi-Fi by pressing the Wi-Fi CONNECT button (WPS) on this unit. (See the separate "Quick Setup Guide".)



NOTE

- The types of routers that can be used depend on the ISP. Contact your ISP or a computer shop for details.
- This unit is not compatible with PPPoE. A PPPoE-compatible router is required if you have a contract for a type of line set by PPPoE.
- Do not connect a NETWORK connector directly to the LAN port/ Ethernet connector on your computer.



Connecting the power cord

After completing all the connections, insert the power plug into the power outlet.

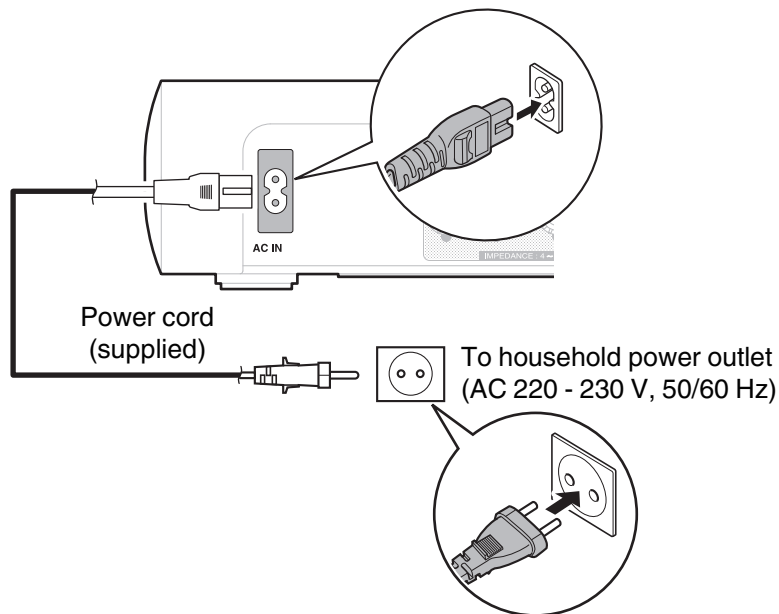

■ Contents

Basic operation

| | |
|-----------------------------------|----|
| Turning the power on | 29 |
| Selecting the input source | 29 |
| Adjusting the volume | 30 |
| Turning off the sound temporarily | 30 |

Playback a device

| | |
|--|----|
| Playing an iPod | 41 |
| Playing a USB memory device | 45 |
| Listening to music on a Bluetooth device | 47 |
| Listening to DIGITAL IN | 53 |
| Listening to ANALOG IN | 53 |

Playback network audio/service

| | |
|--|----|
| Listening to Internet Radio | 31 |
| Playing back files stored on PC or NAS | 35 |
| AirPlay function | 54 |
| Spotify Connect function | 57 |

Other functions

| | |
|-----------------------|----|
| Favorite function | 39 |
| Remote play function | 58 |
| Web control function | 61 |
| Convenience functions | 67 |



Basic operation

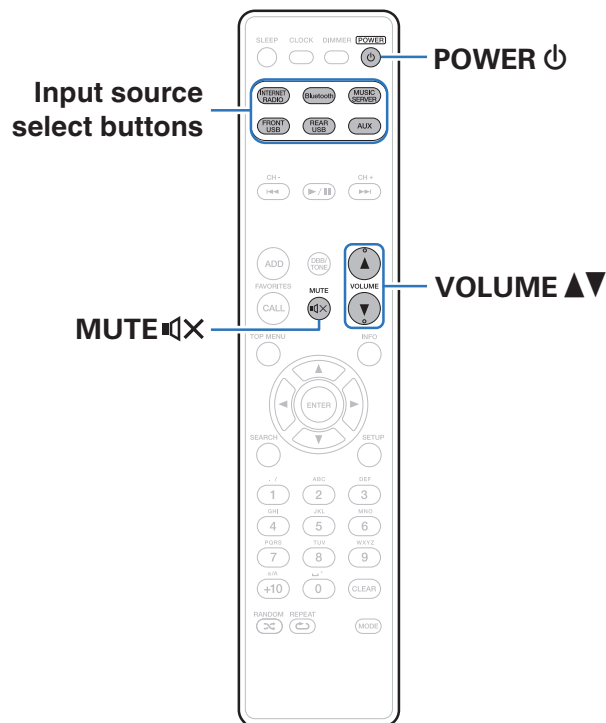

Turning the power on

- 1 Press POWER to turn on power to the unit.



- You can also switch the power to standby by pressing on the main unit.

Selecting the input source

- 1 Press the input source select button to be played back.
The desired input source can be selected directly.



- Press AUX again to switch between AUX:Optical In/AUX:Analog In.
- You can also select the input source by pressing INPUT on the main unit.



Adjusting the volume

1 Use **VOLUME ▲▼** to adjust the volume.

The volume level is displayed.



- You can also adjust the volume by turning **VOLUME ▲▼** on the main unit.

Turning off the sound temporarily

1 Press **MUTE ◀×**.

“MUTING” appears on the display.



- To cancel mute, either adjust the sound volume or press **MUTE ◀×** again.



Listening to Internet Radio

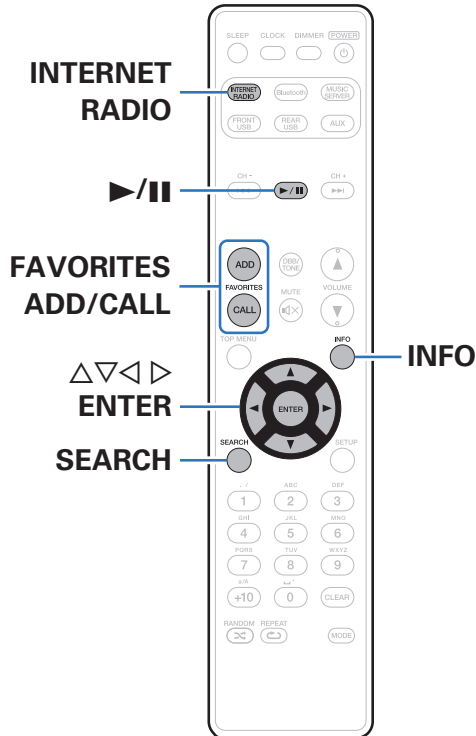

- Internet Radio refers to radio broadcasts distributed over the Internet. Internet Radio stations from around the world can be received.
- The broadcast station types and specifications supported by this unit for playback are as follows.

- **WMA**
- **MP3**
- **MPEG-4 AAC**



Listening to Internet Radio

This unit memorizes the last played Internet Radio station. If you press INTERNET RADIO to switch to the Internet Radio function from another input source, the last Internet Radio station you listened to is played.

1 Prepare for playback.

- Check the network environment, then turn on this unit's power. (☞ p. 24)

2 Press INTERNET RADIO.

3 Use $\Delta\nabla$ to select the you want to play, then press ENTER.

| | |
|--------------------------|---|
| Country name : | Displays typical Internet Radio stations. |
| Search Stations : | Displays all Internet Radio stations that this unit can tune in to. |
| Search Podcasts : | Displays Internet Radio stations in the podcasts that this unit can tune in to. |

Recommended Stations :

Displays recommended Internet Radio stations.

radiomarantz.com :

Displays Internet Radio stations added to favorites in vTuner. For instructions on how to add to favorites in vTuner, see "Using vTuner to add Internet Radio stations to favorites" (☞ p. 34).

Recently Played :

Displays recently played Internet Radio stations. Up to 20 stations can be stored in "Recently Played".



Search by Keyword :

Displays Internet Radio stations searched by keyword. For character input, see "Inputting characters" (☞ p. 75).

4 Use $\Delta\nabla$ to select the station, then press ENTER.

Playback starts once buffering reaches "100%".



| Operation buttons | Function |
|--|---|
|  | Playback / Stop |
| FAVORITES CALL | Call from the Favorite list |
| FAVORITES ADD | Add to the Favorite list |
| SEARCH | Character search <ul style="list-style-type: none"> If the list is not in alphabetical order, you may not be able to perform a character search. |
|  | Select the item |
| ENTER | Enter the selected item |
| INFO | Switching the file type/ bit rate and radio station name etc. |
| TOP MENU | Returns to the top menu of the Internet radio function |



- Any characters that cannot be displayed are replaced with "." (period).

NOTE

- The radio station database service may be suspended or be otherwise unavailable without notice.

Playing the last played Internet Radio station

1 Press INTERNET RADIO.

The source switches to "Internet Radio" and the last played radio station plays.



Using vTuner to add Internet Radio stations to favorites

There are many Internet Radio stations in the world, and this unit can tune into these stations. But finding the radio station you want to hear may be difficult, because there are too many stations. If this is the case, then please use vTuner, an Internet Radio station search website specifically designed for this unit. You can use your PC to search Internet Radio stations and add them as your favorites. This unit can play radio stations added to vTuner.

- 1 Check the MAC address of this unit. “Network Information”** (🔧 p. 84)
 - The MAC address is necessary when you create an account for vTuner.
- 2 Use your PC to access the vTuner website (<http://www.radiomarantz.com>).**
- 3 Enter the MAC address of this unit, then click “Go”.**
- 4 Enter your E-mail address and a password of your choice.**

- 5 Select the search criteria (genre, region, language, etc.) of your choice.**
 - You can also enter a keyword to search for a station you want to hear.
- 6 Select the radio station of your choice from the list, and then click the Add to Favorites icon.**
- 7 Enter the name of the favorite group, then click “Go”.**

A new favorite group that includes the selected radio station is created.

 - Internet Radio stations added to favorites in vTuner can be played from “radiomarantz.com” (🔧 p. 32) with this unit.

■ Files that can be played back

See “Playing back Internet Radio” (🔧 p. 109).



Playing back files stored on a PC and NAS

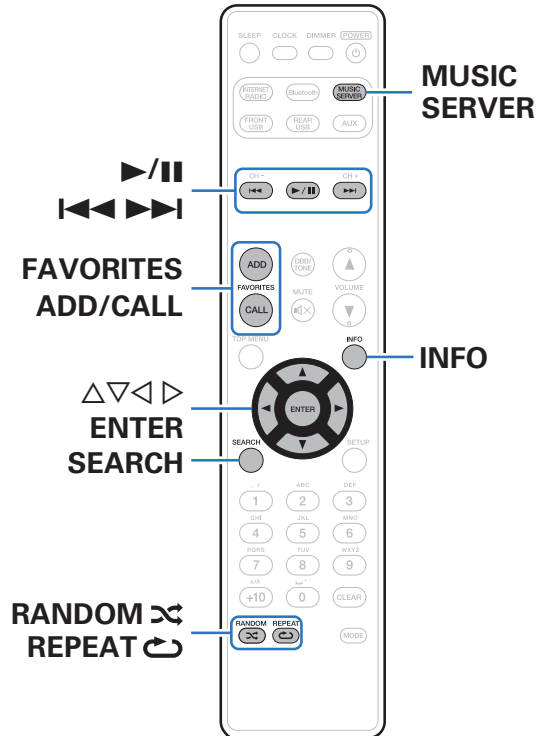

- This unit can play back music files and playlists (m3u, wpl) stored on a PC and on Network Attached Storage (NAS) that supports DLNA.
- The network audio playback function of this unit connects to the server using technologies shown below.
 - Windows Media Player Network Sharing Service
- This unit can play back the following files.
 - WMA
 - MP3
 - WAV
 - MPEG-4 AAC
 - FLAC
 - ALAC
 - AIFF



Applying media sharing settings

Here, we apply the settings to share music files stored on a PC and NAS on the network.

If you are using a Media Server, be sure to apply this setting first.

■ When using Windows Media Player 12 (Windows 7 / Windows 8)

- 1 Start up Windows Media Player 12 on the PC.
- 2 Select “More streaming options...” in the “Stream”.
- 3 Select “Allowed” in the drop-down list for “Marantz M-CR511”.
- 4 Select “Allowed” in the drop-down list for “Media programs on this PC and remote connections...”.
- 5 Follow the instructions on the screen to complete the settings.

■ When using Windows Media Player 11

- 1 Start up Windows Media Player 11 on the PC.
- 2 Select “Media Sharing” in the “Library”.
- 3 Click the “Share my media” check box, select “Marantz M-CR511”, and then click “Allow”.
- 4 As you did in step 3, select the icon of the device (other PCs and mobile devices) you want to use as a media controller, and then click “Allow”.
- 5 Click “OK” to finish.

■ Sharing media stored on a NAS device

Change settings on the Network Attached Storage (NAS) device to allow this unit and other devices (PCs and mobile devices) used as media controllers to access the NAS. For details, see the owner’s manual that came with the NAS.



Playing back files stored on a PC and NAS

Use this procedure to play music files or playlists.

1 Prepare for playback.





- ① Check the network environment, then turn on this unit's power. "Connecting to a home network (LAN)" (👉 p. 24)
- ② Prepare the computer (👉 Computer's operating instructions).

2 Press MUSIC SERVER.

3 Use $\Delta \nabla$ to select the server including the file to be played, then press ENTER.

4 Use $\Delta \nabla$ to select the file, then press ENTER.

Playback starts once buffering reaches "100%".

| Operation buttons | Function |
|--|---|
|  | Playback / Pause (Press and hold) Stop |
|  | Skip to previous track / Skip to next track (Press and hold) Fast-reverse / Fast-forward |
| FAVORITES CALL | Call from the Favorite list |
| FAVORITES ADD | Add to the Favorite list |
| SEARCH | Character search <ul style="list-style-type: none"> • If the list is not in alphabetical order, you may not be able to perform a character search. |
| RANDOM  | Random playback |
| REPEAT  | Repeat playback <ul style="list-style-type: none"> • Switching between Single-track repeat and All-track repeat. |
| $\Delta \nabla \triangleleft \triangleright$ | Select the item |
| ENTER | Enter the selected item |
| INFO | Switching the file type/bit rate, artist name, and album title. |
| TOP MENU | Returns to the top menu of the music server function (server list display) |



■ Files that can be played back

See “Playing back files stored on PC or NAS” ( [p. 110](#)).



- WMA Lossless files can be played when using a server supporting transcoding, such as Windows Media Player Ver. 11 or later.

NOTE

- When playing back music files with your PC or NAS connected through wireless LAN, audio may be interrupted depending on your wireless LAN environment. In this case, play back music files with your PC or NAS connected through wired LAN.
- The order in which the tracks/files are displayed depends on the server specifications. If the tracks/files are not displayed in alphabetical order due to the server specifications, searching by the first letter may not work properly.



Favorite function

This section provides information on the Favorite function.

- The Favorite function allows you to register your favorite broadcast stations and files in the Favorite List in advance so that you can call and listen to the stations or files right away, whenever you want.
- The contents that you can register and call are Internet radio station, music server, USB and iPod (only when using “On-Display” mode).
- Up to 50 items can be stored in the Favorite List.

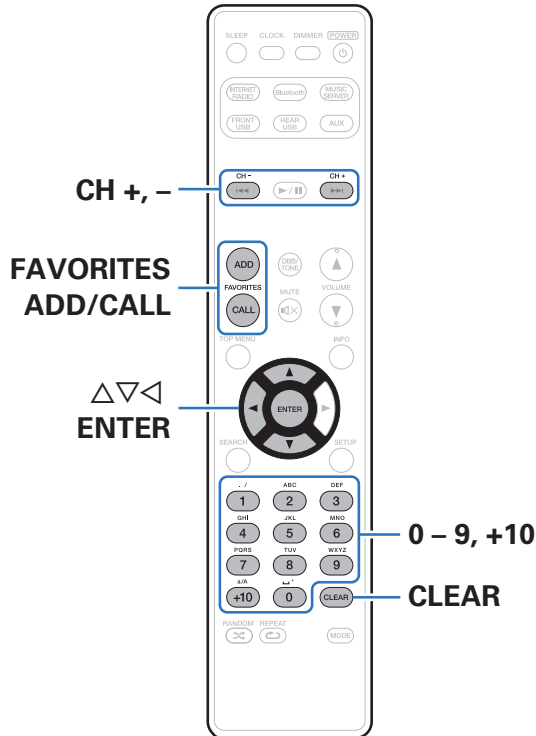

Registering stations or files to the favorites list

- 1 Press **FAVORITES ADD** while the Internet radio station or file to register is played back.
- 2 Use $\Delta\nabla$ to select a number to register the station or file, and press **ENTER**.
“Added To Favorites” is displayed and the registration is completed.

Calling stations or files from the favorites list

- 1 Press **FAVORITES CALL**.
- 2 Use **CH+**, **CH-** or $\Delta\nabla$ to select the station or file that you want to call, and press **ENTER**.
The respective function starts up and playback starts.



- Press 0 – 9, +10 to call files registered to the Favorite list by number.

To switch between registered stations and files during playback

- 1 Use **CH+**, **CH-** or $\Delta\nabla$.

Deleting stations or files from the favorite list

- 1 Press **FAVORITES CALL**.
- 2 Use $\Delta\nabla$ to select the station or file that you want to delete, and press **CLEAR**.
- 3 When the prompt “Delete?” appears, press **ENTER**.
“Deleted” is displayed and the deletion is completed.



- Press < to cancel the operation.



Playing an iPod

- You can use the USB cable provided with the iPod to connect the iPod with the unit's USB port and enjoy music stored on the iPod.
- For information on the iPod models that can be played back with this unit, see "Supported iPod/iPhone models" (p. 23).

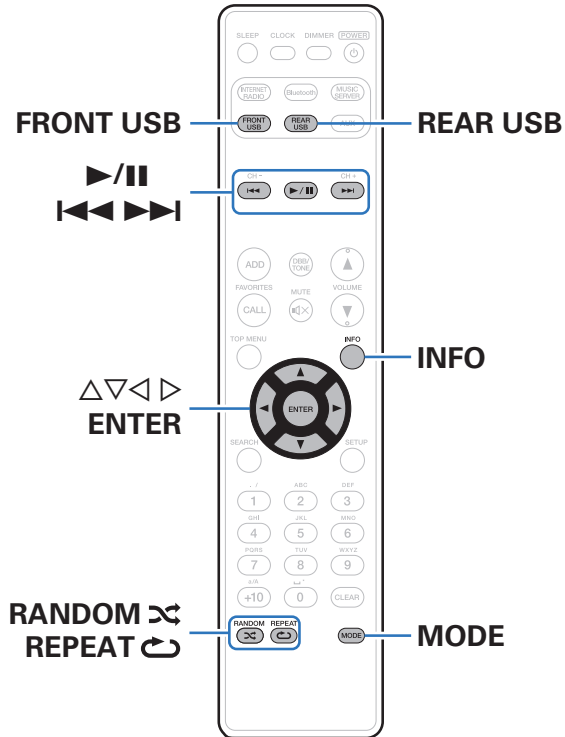

Listening to music on an iPod

1 Connect the iPod to the USB port. (👉 p. 22)

When you connect iPod to the front USB port, the input source automatically switches to “Front USB”.

2 Press FRONT USB or REAR USB to switch the input source to “Front USB” or “Rear USB”.

“From iPod” is displayed on the display of this unit.

3 Operate iPod itself directly while seeing the iPod screen to play back music.



- The iPod display modes include “From iPod” and “On-Display”. By default, “From iPod”, where you directly operate the iPod itself while looking at the iPod screen, is set.
- To change to “On-Display” where operations are performed while the iPod information is displayed on this unit, see “Setting operation mode (“On-Display” mode)” (👉 p. 43).
- You can also listen to iPod music using “AirPlay function” (👉 p. 54).

NOTE

- Depending on the type of iPod and the software version, some functions may not operate.
- Note that Marantz will accept no responsibility whatsoever for any problems arising with the data on an iPod when using this unit in conjunction with the iPod.



Setting operation mode (“On-Display” mode)

In this mode, various lists and screens during playback on the iPod are displayed on the body.





This section describes the steps up to playing back tracks on the iPod in “On-Display”.

- 1 Press **MODE** and display “On-Display”.
- 2 Use $\Delta \nabla$ to select the file to be played, then press **ENTER**.

Playback starts.

| Display mode | | From iPod | On-Display |
|----------------|---------------------------------|-----------|------------|
| Playable files | Music file | ✓ | ✓ |
| | Video file | * | |
| Active buttons | Remote control unit (This unit) | ✓ | ✓ |
| | iPod | ✓ | |

* Only the sound is played.

| Operation buttons | Function |
|---|---|
|  | Playback / Pause (Press and hold) Stop |
|  | Skip to previous track / Skip to next track (Press and hold) Fast-reverse / Fast-forward |
|  | Random playback |
|  | Repeat playback <ul style="list-style-type: none"> • Switching between Single-track repeat and All-track repeat. |
| MODE | Switching between On-Display or From iPod mode. |
| $\Delta \nabla \triangleleft \triangleright$ | Select the item |
| ENTER | Enter the selected item |
| INFO | Switching the artist name and album title. |
| TOP MENU | Returns to the top menu of the iPod function (On-Display mode only) |

NOTE

- Marantz will accept no responsibility whatsoever for any loss of iPod data.
- Depending on the type of iPod and the software version, some functions may not operate.



Charging the iPod/iPhone

You can charge your iPod/iPhone by connecting it to USB port.

■ Standby charging

If the unit enters power standby mode while the iPod/iPhone is charging, the unit will switch to standby charging mode, and the iPod/iPhone will continue to be charged. When in standby charging mode, the power indicator lights turns red.

When the iPod/iPhone is fully charged, the unit automatically stops supplying power for charging and enters normal power standby mode, and the power indicator lights turns off.



Playing a USB memory device

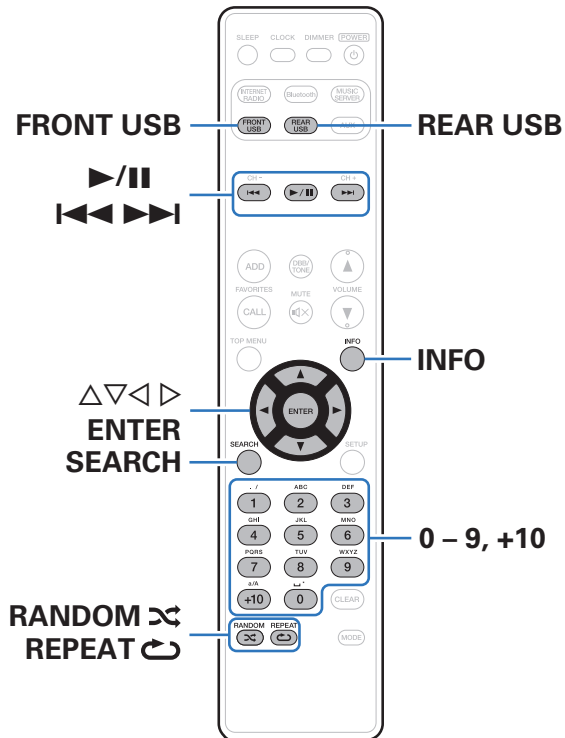

- Playing back music files stored on a USB memory device.
- Only USB memory devices conforming to mass storage class and MTP (Media Transfer Protocol) standards can be played on this unit.
- This unit is compatible with USB memory devices in “FAT16” or “FAT32” format.
- This unit can play back the following files.
 - MP3
 - WMA
 - WAV
 - MPEG-4 AAC
 - FLAC
 - ALAC
 - AIFF



Playing files stored on USB memory devices





1 Connect the USB memory device to the USB port. (p. 22)

When you connect USB memory device to the front USB port, the input source automatically switches to “Front USB”.

2 Press FRONT USB or REAR USB to switch the input source to “Front USB” or “Rear USB”.

3 Use $\Delta \nabla$ to select the file to be played, then press ENTER.

Playback starts.

| Operation buttons | Function |
|--|---|
|  | Playback / Pause (Press and Hold) Stop |
|  | Skip to previous track / Skip to next track (Press and hold) Fast-reverse / Fast-forward |
| RANDOM  | Random playback |
| REPEAT  | Repeat playback <ul style="list-style-type: none"> Switching between Single-track repeat and All-track repeat. |
| SEARCH | Character search <ul style="list-style-type: none"> If the list is not in alphabetical order, you may not be able to perform a character search. |
| $\Delta \nabla \triangleleft \triangleright$ | Select the item |
| ENTER | Enter the selected item |
| INFO | Switching the artist name and album title. |
| TOP MENU | Returns to the top menu of the USB function |

NOTE

- Note that Marantz will accept no responsibility whatsoever for any problems arising with the data on a USB memory device when using this unit in conjunction with the USB memory device.

■ Files that can be played back

See “Playing back USB memory devices” ( p. 107).



Listening to music on a Bluetooth device

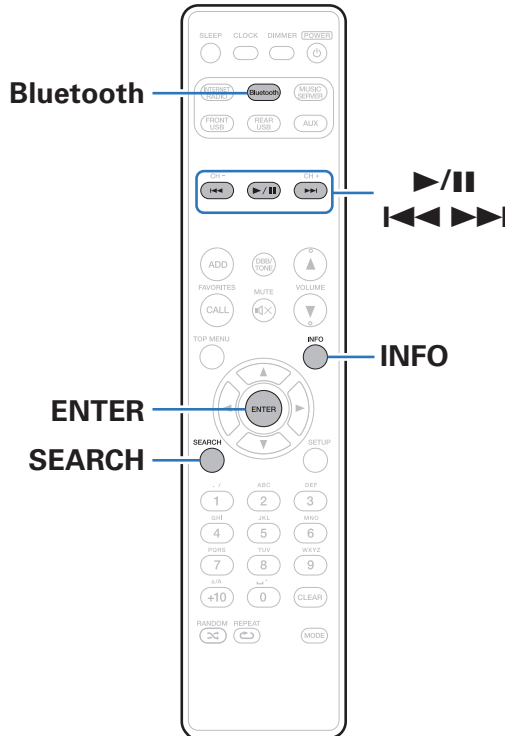

Music files stored on Bluetooth devices such as smartphones, digital music players, etc. can be enjoyed on this unit by pairing and connecting this unit with the Bluetooth device.

Communication is possible up to a range of about 10 m.

NOTE

- To play back music from a Bluetooth device, the Bluetooth device needs to support the A2DP profile.



Playing music from Bluetooth device

In order to enjoy music from a Bluetooth device on this unit, the Bluetooth device must first be paired with this unit.

Once the Bluetooth device has been paired, it does not need to be paired again.

1 Press Bluetooth to switch the input source to “Bluetooth”.

When using for the first time, the unit will go into the pairing mode automatically and “Pairing Mode” will appear on the display of the unit.

2 Activate the Bluetooth settings on your mobile device.

3 Select this unit when its name appears in the list of devices displayed on the screen of the Bluetooth device.

Connect to the Bluetooth device while “Pairing Mode” is being displayed on the display of the unit.

Perform the connection with the Bluetooth device close to the unit (about 1 m).

4 When a number appears on the display of this unit, check that it is the same number as that shown on the screen of the Bluetooth device and then select “pair” for both the Bluetooth device and the unit. (To select “pair” on this unit, press ENTER on the unit.)

At the end of the pairing, the device name appears on the display of this unit.



5 Play music using any app on your Bluetooth device.

- The Bluetooth device can also be operated with the remote control of this unit.
- The next time the input source is switched to Bluetooth, this unit automatically connects to the last Bluetooth device that was connected.



- Enter “0000” when the password is requested on the screen of the Bluetooth device.



| Operation buttons | Function |
|--|---|
|  | Playback / Pause |
|  | Skip to previous track / Skip to next track (Press and hold) Fast-reverse / Fast-forward |



- Press INFO on the remote control unit during playback to switch the display between Artist name, Album name, etc.
- Incompatible characters are displayed as “.” (period).

NOTE

- To operate the Bluetooth device with the remote control of this unit, the Bluetooth device needs to support the AVRCP profile.
- The remote control of this unit is not guaranteed to work with all Bluetooth devices.
- Depending on the type of Bluetooth device, this unit outputs audio that is coupled to the volume setting on the Bluetooth device.



Pairing with other Bluetooth devices

Pair a Bluetooth device with this unit.

1 Activate the Bluetooth settings on your mobile device.

2 Press SEARCH when the input source is “Bluetooth”.

The device will go into the pairing mode.

3 Select this unit when its name appears in the list of devices displayed on the screen of the Bluetooth device.

4 When a number appears on the display of this unit, check that it is the same number as that shown on the screen of the Bluetooth device and then select “pair” for both the Bluetooth device and the unit. (To select “pair” on this unit, press ENTER on the unit.)

At the end of the pairing, the device name appears on the display of this unit.



- This unit can be paired with a maximum of 8 Bluetooth devices. When a 9th Bluetooth device is paired, it will be registered in place of the oldest registered device.
- Enter “0000” when the password is requested on the screen of the Bluetooth device.
- Either press and hold Bluetooth for 3 seconds, or switch the input source to “Bluetooth” and then press and hold INPUT on this unit for more than 3 seconds to switch to pairing mode.



Reconnecting to this unit from a Bluetooth device

After pairing is completed, the Bluetooth device can be connected without performing any operations on this unit.

This operation also needs to be performed when switching the Bluetooth device for playback.

- 1 If a Bluetooth device is currently connected, deactivate the Bluetooth setting of that device to disconnect it.**
- 2 Activate the Bluetooth setting of the Bluetooth device to be connected.**
- 3 Select this unit from the Bluetooth device list on your Bluetooth device.**
- 4 Play music using any app on your Bluetooth device.**



- When the power of this unit is turned on, the input source will be automatically switched to "Bluetooth" if a Bluetooth device is connected.
- When the "Network Control" setting of this unit is set to "On" and a Bluetooth device is connected with the unit in the standby state, the power of the unit will be turned on automatically.

Connecting a Bluetooth device with the NFC function via NFC

You can just touch this unit with a Bluetooth device to turn on power to this unit and perform pairing or establish a connection between this unit and the Bluetooth device.

- 1 Turn on the NFC function on the Bluetooth device.**
 - For details, see the owner's manual for your Bluetooth device.
- 2 Touch  on this unit with the NFC antenna part on the Bluetooth device.**

If a pairing confirmation screen is displayed, follow the instructions on this unit and the Bluetooth device to complete pairing.

 - Complete operations as instructed by the Bluetooth device.

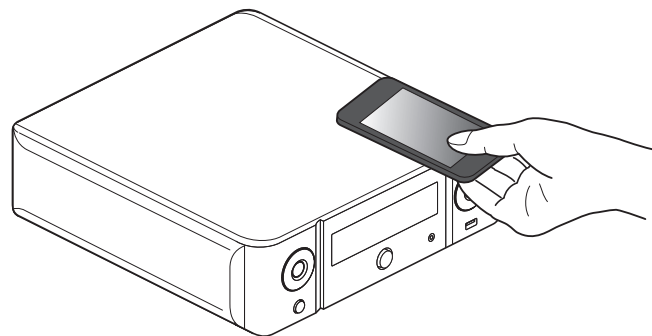

3 Play back music on the Bluetooth device.

This unit outputs music from the Bluetooth device.



- When “Network Control” is set to “On”, startup and connection can be performed even when the unit power is off.
- When you touch the N mark (N) on this unit with the Bluetooth device that is playing back music, this unit outputs that music.
- Touch the N mark (N) again during the Bluetooth connection to disconnect the connection.
- Touch the N mark (N) again if pairing or connection with the Bluetooth device fails.

NOTE

- Before establishing a NFC connection, cancel the lock function on the Bluetooth device.
- When you touch this unit with a Bluetooth device, do so softly.





Listening to DIGITAL IN

- 1 Prepare for playback.**
Check the connection, then turn on this units.
- 2 Press AUX to select “AUX:Optical In”.**
- 3 Play the component connected to this unit.**



- Only 2-channel linear PCM digital audio signals can be inputted through the DIGITAL IN connector of this unit.

Listening to ANALOG IN

- 1 Prepare for playback.**
Check the connection, then turn on this units.
- 2 Press AUX to select “AUX:Analog In”.**
- 3 Play the component connected to this unit.**



AirPlay function

Music files stored on your iPhone, iPod touch, iPad or iTunes can be played on this unit via the network.



- You can stop AirPlay playback by pressing < or choosing other input source.
- To see song and artist names together, press INFO on the remote control unit.
- For information about how to use iTunes, also see the Help for iTunes.
- The screen may differ depending on the OS and software versions.

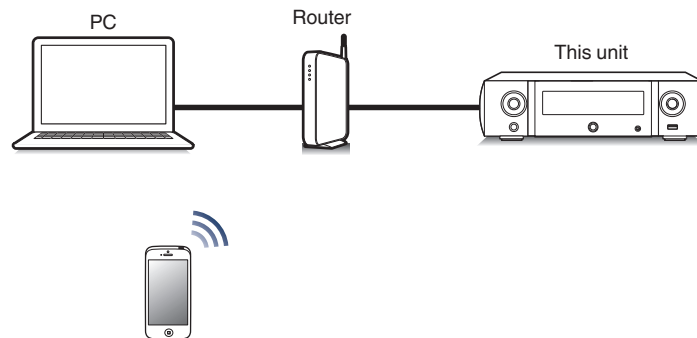

Playing songs from your iPhone, iPod touch or iPad

If you update your “iPhone/iPod touch/iPad” to iOS 4.2.1 or later, you can stream music stored in your “iPhone/iPod touch/iPad” directly to this unit.

1 Connect your iPhone, iPod touch or iPad Wi-Fi to the same network as this unit.

- For details, see your device’s manual.

2 Play the song on your iPhone, iPod touch or iPad.

 is displayed on the iPhone, iPod touch or iPad screen.

3 Tap the AirPlay icon .

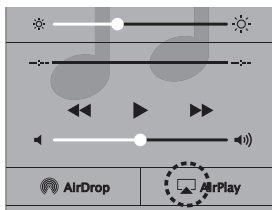

4 Select this unit.

Playing iTunes music with this unit

1 Install iTunes 10, or later, on a Mac or Windows PC that is connected to the same network as this unit.

2 Turn this unit ON.

Set “Network Control” to “On” for this unit. ( p. 84)

NOTE

- When “Network Control” is set to “On”, the unit consumes more standby power.

3 Start iTunes and click the AirPlay icon to select the main unit.



4 Choose a song and click play in iTunes.

The music will stream to this unit.



Selecting multiple speakers (devices)

It is possible to play iTunes songs on your home's AirPlay compatible speakers (devices) other than those of this unit.

- 1 Click the AirPlay icon  and select "Multiple".
- 2 Check the speakers you want to use.

NOTE

- In playback using the AirPlay function, the sound is output at the iPhone, iPod touch, iPad or iTunes volume setting level.
You should turn down the iPhone, iPod touch, iPad or iTunes volume prior to playback and then adjust it to a suitable level.



Spotify Connect function

Spotify is the world's most popular streaming service. If you subscribe to Spotify Premium, you can control your new speaker with your phone or tablet. Because Spotify is built-in to your speaker, you can still take calls or use other apps - the music never stops.

For information on how to set up and use Spotify Connect please visit www.spotify.com/connect

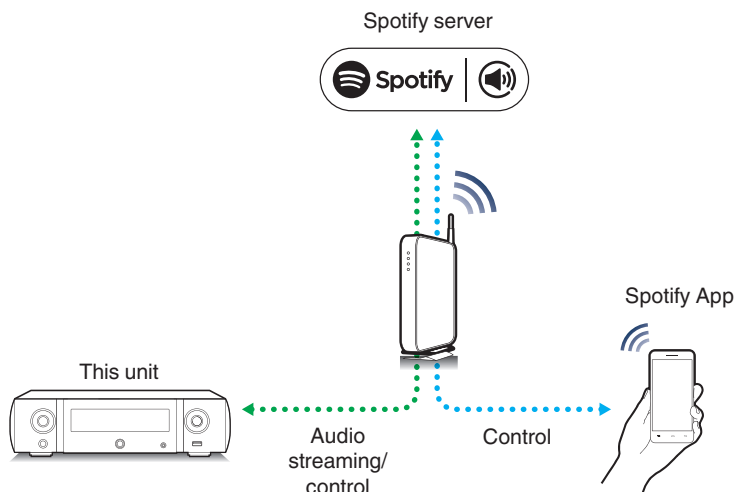

Playing Spotify music with this unit

Download the "Spotify App" onto your Android or iOS device beforehand. To play a Spotify track in this unit, you need to register in the Spotify premium account first.

- 1 Connect the Wi-Fi settings of the iOS or Android device in the same network as this unit.**
- 2 Launch the Spotify App.**
- 3 Play back the Spotify track.**
- 4 Tap the  icon to select the unit.**
The music will stream to this unit.



Remote play function

You can use your home network to play back with this unit music files stored on PC, NAS, smartphones and portable audio players.

In this case, you use PC, smartphones and portable audio players for operations.



- The relevant devices should comply with the DLNA (Digital Living Network Alliance) Ver. 1.5 standard.
- A wireless LAN environment is required for playing back music files on smartphones or portable audio players.
- For some smartphones, you must install an application for DLNA music playback.

■ Roles each device plays

The following devices are used for Remote Play. As specified in the DLNA standard, these devices are called DMC, DMS or DMR according to their role.

| Name | Device example | Role |
|--|---|---|
| DMC (Digital Media Controller) | <ul style="list-style-type: none"> • PC • Smartphone • Portable audio player • Marantz Hi-Fi Remote | Performs Remote Play operations. DMC can also play back music files stored on these devices. |
| DMS (Digital Media Server) | <ul style="list-style-type: none"> • PC • NAS (Network Attached Storage) | Stores music files. Music files stored on these devices are played back with DMC. |
| DMR (Digital Media Renderer) | <ul style="list-style-type: none"> • This unit | Outputs audio of music files played back through Remote Play from speakers. DMR cannot perform playback operations. |

■ Files that can be played back

See “Playing back files stored on PC or NAS” ( p. 110).



Settings required for each device

You must make settings on DMC and DMS for Remote Play. Make the following settings. Also see the owner's manual of each device for settings.

■ Settings on computer and NAS

Make settings on computer and NAS to exchange data with DMR devices.

For details on the settings, see "Applying media sharing settings" (🔍 p. 36).

■ Settings on smartphones

You must install an application for DLNA music playback on your smartphone to perform operations on DMS and this unit (DMR) with your smartphone. The applicable application differs according to your smartphone.



- Some smartphones support DLNA music playback with the factory settings. See the owner's manual of your smartphone.

■ Settings on portable audio players

Configure the settings so that this unit (DMR) can play back music files stored on your portable audio player. For details on the settings, see the owner's manual of your portable player.

■ Settings on this unit

Connect this unit to the DLNA network. You do not need to make other settings.

For the network connection, see the provided "Quick Setup Guide", "Connecting to a home network (LAN)" (🔍 p. 24) and "Settings" (🔍 p. 86).



■ Remote Play operations

Operations are different for each device, but the procedures for preparing for Remote Play are the same. The preparation procedures are shown below.

1 Turn on this unit.

- Make sure that this unit is connected to the network.

2 Display the music file playback screen on DMC.

- For PC, open Windows Media Player 12, etc.
- For smartphones, switch to the music file playback mode.

3 Select the friendly name of this unit for the item that sets the playback device on the playback screen.

- The default Friendly Name of this unit is “Marantz M-CR511”.

4 Start playing back a music file on DMC.

- The function on this unit automatically switches to “Music Server” and the Remote Play mark  appears on the display. Remote Play starts.



- Press < to exit Remote Play mode.

NOTE

- During Remote Play, you cannot perform playback operations with this unit. Use the DMC device for these operations.



Web control function

You can control this unit from a web control screen on a web browser.

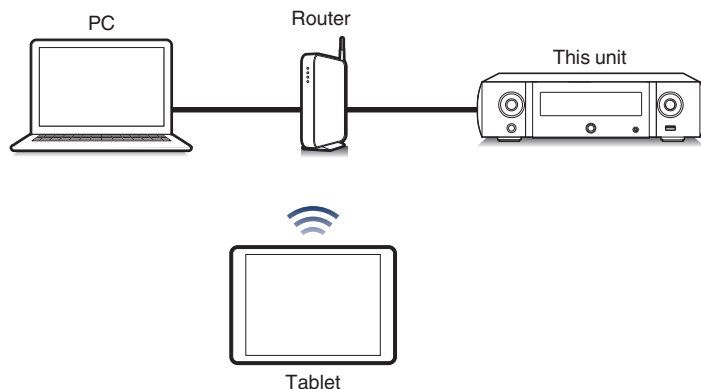

- This unit and the PC or tablet need to be connected to the network properly in order to use the web control function. “Connecting to a home network (LAN)” (☞ p. 24)
- Depending on the settings of your security-related software, you may not be able to access this unit from your PC. If this is the case, then change the settings of the security-related software.

Controlling the unit from a web control

- 1 Switch the “Network Control” setting to “On”. (☞ p. 84)
- 2 Check the IP address of this unit with “Network Information”. (☞ p. 84)



Checking the IP address.

- 3 Start up the web browser.



4 Enter the IP address of this unit in browser's address box.

For example, if the IP address of this unit is "192.168.0.2", enter "http://192.168.0.2".

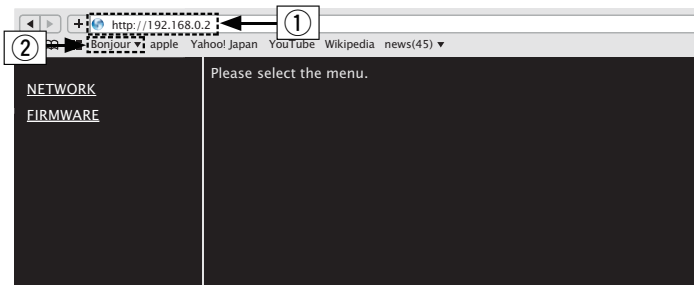

- ① Entering the IP address.
- ② If you are using the Safari web browser, you can select "Bonjour" and directly access the unit's web control screen from the overview section.



- By adding this unit's IP address to the browser's bookmark, you can display the web control screen using the bookmark function the next time you use the browser. If you are using a DHCP server and "Network Control" (ⓘ p. 84) is set to "Off", turning the power on/off changes the IP address.

5 When the top menu is displayed, click on the menu item you want to operate.

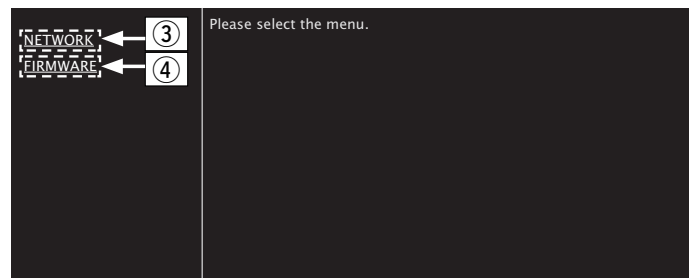

- ③ Click when you setup network settings. (ⓘ [Example 1])
- ④ Click when you update firmware.



6 Operate.

[Example 1] Network Setting 1

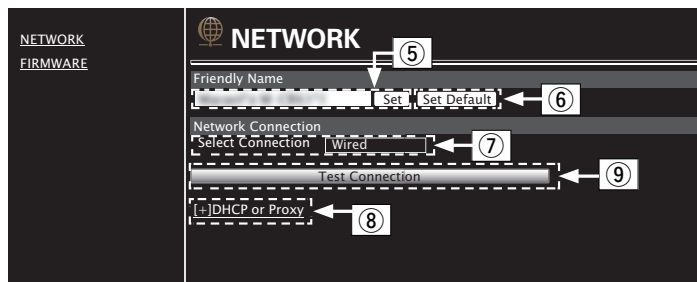

❑ Friendly Name setting

- ⑤ To change the Friendly Name, enter the new name in the text box and click "Set".
- ⑥ To reset the Friendly Name, click "Set Default".



- Only characters that can be displayed on this unit can be set. (🔍 p. 75)

❑ Network connection settings

- ⑦ Click to change the network connection method. If you select "Wi-Fi", a new item will appear on-screen. (🔍 [Example 2])
- ⑧ Click to change DHCP/proxy settings. (🔍 [Example 2])
- ⑨ Click to connect using the newly applied settings.



7 Operate.

[Example 2] Network Setting 2

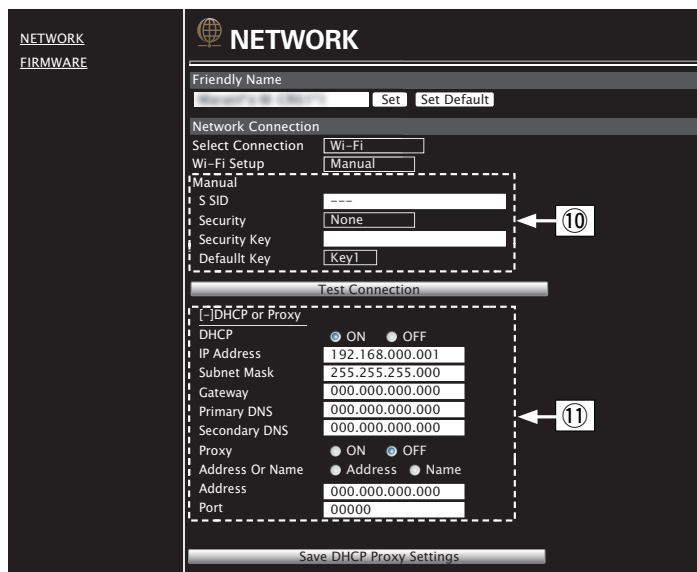

❑ Network connection settings

- ⑩ [Example 2] - Displayed when “Wi-Fi” is selected in ⑦. Select or input items as necessary, and then click “Test Connection” to apply the changes.
- Items displayed may vary depending on selected items and connection status.
 - After selecting each item, wait a moment for the display to be updated.
- ⑪ [Example 2] - Displayed when “DHCP” or “Proxy” is selected in ⑧. When changing DHCP/proxy settings, input or select for each item.



- To apply network connection settings, click “Test Connection” after making changes.



Update on web screen

“Web control function” (☞ p. 61) settings must be completed in advance on a computer belonging to the same network. For information on obtaining update files, please contact our customer service center.

1 Click ④ from step 5 for the “Web control function”. (☞ p. 61)

The PC will display the following screen.

Wait for approximately 1 minute.

You can also gain access by entering the IP address shown by the unit into a web browser.

[The web display]

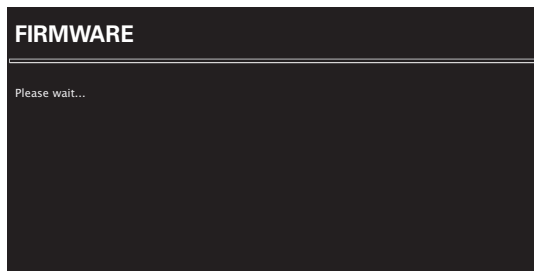

[The unit's screen display]

IpAddress
192.168.xxx.xxx

2 When the following screen is displayed by the PC, click the “Choose File” (①) button, select the update file, and click the “Upload” (②) button.

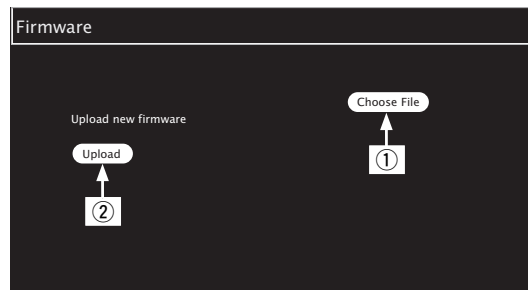

3 Click “OK”. Updating will begin.

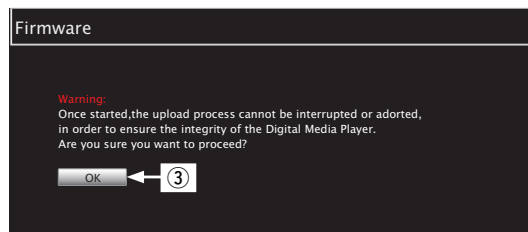

NOTE

- Do not operate the unit while updating is in progress.



4 When the following screen is displayed, updating is complete.

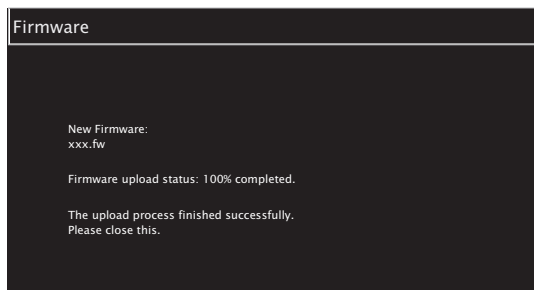

- Button names may vary depending on the OS language used on your computer.



Convenience functions

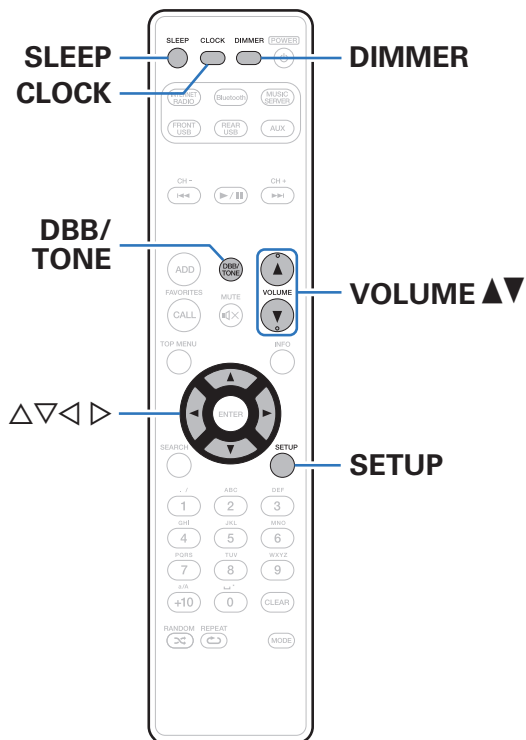

| | |
|------------------------------------|----|
| Adjusting the tone | 68 |
| Sleep timer function | 69 |
| Checking the current time | 69 |
| Switching the display's brightness | 70 |



Adjusting the tone

- 1 Press **DBB/TONE** to select the tone parameter to be adjusted.
- 2 Use $\Delta \nabla$ to adjust the “Dynamic Bass Boost”, “Bass”, “Treble”, “Balance” or “S.Direct”.

Dynamic Bass Boost

Emphasizes the bass sound in stages according to the volume (maximum +8 dB).

On / Off (Default: Off)

Bass

Adjusts the bass sound.

-10dB – +10dB (Default : 0dB)

Treble

Adjusts the treble sound.

-10dB – +10dB (Default : 0dB)

Balance

Use $\triangleleft \triangleright$ to adjust the left/right volume balance.

S.Direct

The “Dynamic Bass Boost”, “Bass”, “Treble” and “Balance” are not adjusted.

On / Off (Default: Off)



- When “Speaker Response” is set to other than “Flat”, the setting is enabled even if “S.Direct” is “On”. (🔗 p. 79)



Sleep timer function

You can have the power automatically switched to standby once a set time has elapsed. This is convenient for listening while going to sleep.

1 Press SLEEP during playback and select the setting time.

- The  indicator on the display lights.
- You can set the sleep timer in the range from 10 to 90 minutes in steps of 10 minutes.

■ To cancel the sleep timer

Press SLEEP to set "Sleep ►Off".

The  indicator on the display turns off.



- The sleep timer setting is canceled when the unit switches to standby mode.
- To check the time remaining until the sleep timer is activated, press SLEEP.

Checking the current time

■ Checking the current time when the power is on

Press CLOCK.

- Press once more and the display returns to its original condition.

■ Checking the current time when the power is set to standby

Press CLOCK.

- The current time is displayed for 30 seconds.



- The time cannot be set when in the standby mode. Turn on the power first.



Switching the display's brightness

1 Press DIMMER.

- The brightness of the display switches each time the button is pressed (5 levels).



- If the buttons are operated when the display is turned off, information is displayed temporarily at a low brightness level.



Menu map

For menu operations, see the following page.

By default, this unit has recommended settings defined. You can customize this unit based on your existing system and your preferences.

■ Quick Setup

| Setting items | Description | Page |
|---------------|--|------|
| Quick Setup | Performs the network settings using a Wizard style window. For details on the operations, see the separate "Quick Setup Guide". | - |



■ General

| Setting items | Description | Page |
|-------------------------|---|--------------------|
| Alarm | Sets the timer playback. | 77 |
| Clock | Sets the current time. | 78 |
| Clock Mode | The clock is constantly displayed. | 78 |
| Volume Limit | Make a setting for maximum volume. | 79 |
| Speaker Response | Set the output frequency characteristics. | 79 |
| Language | Sets the language for display the menu. | 80 |
| Auto-Standby | Sets the unit power to standby when the unit is not in use. | 80 |
| Usage Data | Selects whether or not to send anonymous usage data to Marantz. | 80 |
| Firmware | Set whether or not to check for firmware update, update the firmware, and display update and upgrade notifications. | 81 |
| Update | Update the firmware of this unit. | 81 |
| Notifications | Set the Update, Upgrade and Alerts notification on/off. | 81 |
| Add New Feature | Display new features that can be downloaded to this unit and perform an upgrade. | 82 |
| Reset | Resetting factory settings. | 83 |



■ Network

| Setting items | Description | Page |
|---|---|--------------------|
| Network Information | Displays various information about the network. | 84 |
| Network Control | Performs the ON/OFF settings for the network function when in standby mode. | 84 |
| Friendly Name | Edits a name displayed on the Internet. | 85 |
| Wi-Fi | Enables/disables the Wi-Fi function. | 85 |
| Bluetooth | Enables/disables the Bluetooth function. | 85 |
| Settings | Performs the settings for a wired or wireless LAN. | 86 |
| Wired Setup | Performs the settings for a wired LAN. | 86 |
| DHCP (On) or DHCP (Off) | Performs the DHCP setting. | 86 |
| IP Address * | Performs the IP address setting. | 86 |
| Subnet Mask * | Performs the subnet mask setting. | 86 |
| Gateway * | Performs the gateway setting. | 86 |
| Primary DNS * | Performs the primary DNS setting. | 86 |
| Secondary DNS * | Performs the Secondary DNS setting. | 86 |
| Proxy | Performs the proxy setting. | 87 |
| Test Connection | Performs the wired LAN connection. | – |
| Wi-Fi Setup Method | Performs the wireless LAN connection setting. | 87 |
| Auto-Scan | Selects and sets the wireless connections from the access point list. | 88 |
| Share Wi-Fi setting from an iOS device | Sets the wireless connection using an iOS device. (iOS version 7 or later) | 88 |
| WPS (Wi-Fi Protected Setup) | Sets the wireless connection using WPS (Wi-Fi Protected Setup). | 88 |
| Web Browser Setup | Sets the wireless connection using web browser. | 89 |
| Manual | Sets the wireless connection manually. | 91 |

* Displayed when the "DHCP" setting is "Off". (☞ p. 86)



Menu operation

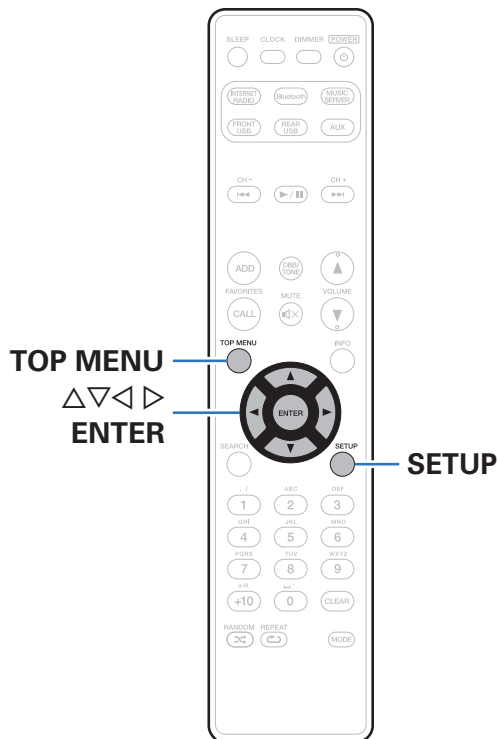

1 Press **SETUP**.

The menu is displayed.

2 Use **Δ▽◀▶** to select the menu to be set or operated, then press **ENTER**.

3 Use **Δ▽** to change to desired setting.

4 Press **ENTER** to enter the setting.

- To return to the previous item, press **◀**.
- Exiting the Menu, press **SETUP** while the menu is displayed. The menu display disappears.
- To back to the top of the menu, during menu operation, press **TOP MENU**.



Inputting characters

On this unit, you can change the name displayed on the following screens to the names that you prefer.

- Friendly Name (🔍 p. 85)
- Character input for the network functions (🔍 p. 32)

Using the number buttons

- 1 **Display the screen for inputting characters.**
 - To change a character, use \triangleleft \triangleright to align the cursor with the character that you want to change.
- 2 **Press +10 to select the character type (upper case, lower case, or numeric characters).**

- 3 **Press 0 – 9, +10 until the desired character is displayed.**
 - The types of characters that can be input are as shown below.

| | | | |
|-------|---------------|-----------------|--|
| 1 . / | 1 . @ - _ / : | 6 MNO | m n o M N O 6 |
| 2 ABC | a b c A B C 2 | 7 PQRS | p q r s P Q R S 7 |
| 3 DEF | d e f D E F 3 | 8 TUV | t u v T U V 8 |
| 4 GHI | g h i G H I 4 | 9 WXYZ | w x y z W X Y Z 9 |
| 5 JKL | j k l J K L 5 | 0 [] ^ ' { } | 0 (Space) ! " # \$ % & ' () * + , ; < = > ? [\] ^ ' { } |

- 4 **Repeat steps 2 and 3 to change the name then press ENTER to register it.**



Using the cursor buttons

1 Display the screen for inputting characters.

- To change a character, use <◀▶> to align the cursor with the character that you want to change.

2 Use Δ∇ to change the character.

- The types of characters that can be input are as shown below.

[Lower case]

abcdefghijklmnopqrstuvwxyz

[Upper case]

ABCDEFGHIJKLMNOPQRSTUVWXYZ

[Symbols] ! " # \$ % & ' () * + , - . / : ; < = > ? @
[\] ^ _ ` { | } ~**[Numbers]** 0123456789 (Space)

3 Repeat step 2 to change the name then press ENTER to register it.



- Press CLEAR to delete the character.
- Press ▶▶I to insert a space.



General

Make various other settings.

Alarm

Set the once alarm and everyday alarm.

■ Once

| | |
|----------------------------|-----------------------------|
| Once Alarm Setting: | Set the once alarm to on. |
| Off: | The alarm does not operate. |

■ Every Day

| | |
|-------------------|-------------------------------|
| Every Day: | Set the everyday alarm to on. |
| Off: | The alarm does not operate. |

■ Edit Alarm

Edit the once alarm and everyday alarm.

- 1 Use $\Delta\nabla$ to select the alarm mode, then press ENTER.
- 2 Use $\Delta\nabla$ to setting for the alarm start time, then press ENTER.
- 3 Use $\Delta\nabla$ to select the input source, then press ENTER.
 - When “Bluetooth” is selected, this unit attempts to connect to the previously connected device.
- 4 Use $\Delta\nabla$ to select the volume level “00 – 60”, then press ENTER.

The display shows “Complete!!” and the setting is completed.

- The power indicator lights orange when the unit is switched to standby mode in this state.



Clock

■ Set the current time

You can automatically adjust the clock of this unit using the Internet.



- To use this function, the unit must be connected to the Internet.

1 Use Δ / ∇ to select your time zone, then press ENTER.

2 Use Δ / ∇ to select the summer time, then press ENTER.

On: Set the summer time to on.

Off
(Default): Set the summer time to off.

Clock Mode

The clock is constantly displayed.

On:

Display the clock.
Press the POWER \downarrow button to switch between the clock display and the normal display.

Off
(Default):

Does not display the clock.

NOTE

- When "Clock Mode" is set to "On", the unit consumes more standby power.



Volume Limit

■ Make a setting for maximum volume

Limits the volume to ensure safe use of this product, and also makes it easier to adjust the volume from AirPlay or an app to an ideal range.

30 / 45 / 60(Full throttle) / Other (Default : 30)

When "Other" is selected, the volume upper limit can be set within the range of 16 - 60. Select the value using Δ / ∇ and then press ENTER to enter the setting value.



When the maximum volume is set, if you increase the volume to the setting value and press VOLUME▲ again, "Allow max volume?" is displayed. If you press VOLUME▲ again the maximum volume limit is canceled.

Speaker Response

Set the output frequency characteristics.

| | |
|----------------------------|---|
| Flat (Default) : | Properties are flat. |
| Response1 : | Cuts low frequencies 40 Hz or under by -12 dB/oct. |
| Response2 : | Cuts low frequencies 60Hz or under by -12 dB/oct. |
| Response3 : | Cuts low frequencies 80 Hz or under by -12 dB/oct. |
| Response4 : | Cuts low frequencies 100 Hz or under by -12 dB/oct. |



- "Speaker Response" setting values are not reflected in headphone out, Audio out or subwoofer out.



Language

Set the language for display on the menu.

English / Deutsch / Française / Italiano / Nederlands / Español / Svenska / Русский / Polski (Default :English)

Auto-Standby

When “Auto-Standby” is set to “On”, and no operations are made in the stopped state for the set amount of time, this unit automatically enters standby mode.

For the input source “From iPod” only, when no operation is performed for eight hours, this unit automatically enters the standby mode.

| | |
|---------------------------------|--|
| 1min / 5min / 15min / | When “Other” is selected, the “Auto-Standby” time can be set within the range of 1 - 99 minutes. |
| Other (Default : 15min): | Select the value using Δ / ∇ and then press ENTER to enter the setting value. |
| Off: | The unit does not go into standby automatically. |

Usage Data

For product improvement purposes, please send information on the device settings and operating conditions of the functions to Marantz. Information provided by customers will be used as reference material for product development purposes in the future.

Marantz will never provide any information we collect to third parties.

| | |
|-------------|--|
| Yes: | Provide information on the operating status of this unit. |
| No: | Do not provide information on the operating status of this unit. |



Firmware

Set whether or not to check for firmware update, update the firmware, and display update, upgrade and alert notifications.

■ Update

Update the firmware of this unit.

| | |
|--------------------------|-----------------------------|
| Check For Update: | Check for firmware updates. |
|--------------------------|-----------------------------|

| | |
|----------------------|-----------------------------|
| Update Start: | Execute the update process. |
|----------------------|-----------------------------|



- Even if the update fails, this unit will automatically try to update again.

■ Notifications

Notification messages are displayed in the screen when the power is switched on when new firmware can be used, or when there are other notification messages.

Update

| | |
|-------------------------|-------------------------|
| On (Default): | Display update message. |
|-------------------------|-------------------------|

| | |
|-------------|--------------------------------|
| Off: | Do not display update message. |
|-------------|--------------------------------|

Upgrade

| | |
|-------------------------|--------------------------|
| On (Default): | Display upgrade message. |
|-------------------------|--------------------------|

| | |
|-------------|---------------------------------|
| Off: | Do not display upgrade message. |
|-------------|---------------------------------|

Notification Alerts

| | |
|-------------------------|--|
| On (Default): | Displays notification messages from Marantz in the popup menu. |
|-------------------------|--|

| | |
|-------------|--|
| Off: | Does not display notification messages from Marantz in the popup menu. |
|-------------|--|



■ Add New Feature

Display new features that can be downloaded to this unit and perform an upgrade.

| | |
|-------------------------|--|
| Upgrade package: | Display the items to be upgraded. |
| Upgrade Status: | Display a list of the additional functions provided by the upgrade. |
| Upgrade Start: | Execute the upgrade process. When the upgrade starts, the menu screen is shut down. During the upgrade, the amount of upgrade time which has elapsed is displayed. |
| Upgrade ID: | The ID number shown on the display is needed when carrying out the procedure. |



- See the Marantz website for details about upgrades.
- When the procedure is complete, “Registered” is displayed in this menu and upgrades can be carried out. If the procedure has not been carried out, “Not Registered” is displayed.

Notes concerning use of “Update” and “Add New Feature”

- In order to add new functions, the environment and settings required for connecting to broadband internet are needed. (p. 24)
- Perform the add new feature operation after at least 2 minutes has elapsed since turning this unit’s power on.
- Do not turn off the power until updating or upgrading is completed.
- Even with a broadband connection to the Internet, approximately 20 minutes is required for the updating/upgrading procedure to be completed.
- Once updating/upgrade starts, normal operations on this unit cannot be performed until updating/upgrading is completed. Furthermore, updating/upgrading the firmware may reset the backup data for the parameters, etc. set for this unit.
- When the update or upgrade failed with a message such as “Update failed” and “Download failed”, remove and re-insert the power cord. “Update Retry” appears on the display and update restarts from the point at which update failed. If the error continues despite this, check the network environment.



- Information regarding the “Update” function and “Add New Feature” will be announced on the Marantz web site each time related plans are defined.



Reset

Perform this procedure if the display is abnormal or if operations cannot be performed. Various settings are reset to the factory default values. Make settings again.

Cancel: Values are not reset.

Reset factory defaults: Values are reset.



Network

To use this unit by connecting it to a home network (LAN), you must configure network settings. If you set up your home network via DHCP, set “DHCP” to On (use the default setting). This allows this unit to use your home network.

If you assign an IP address for each device, you must use the “IP Address” setting to assign an IP address to this unit and enter the information about your home network such as the gateway address and subnet mask.

Network Information

Display network information.

Friendly Name / DHCP On or Off / IP Address / MAC Address / SSID*

* This is displayed only while a Wi-Fi connection is enabled.

Network Control

Enables network communication in standby power mode.

On: The network function can be used when in standby power mode. Main unit operable with a network compatible controller.

Off (Default): The network function cannot be used in standby power mode.



- When using the Web control function or a network controller or when you want to use Bluetooth/NFC quickly when the power is off, set “Network Control” to “On”.

NOTE

- When “Network Control” is set to “On”, the unit consumes more standby power.



Friendly Name

The Friendly Name is the name of this unit displayed on the network. You can change the Friendly Name according to your preferences.

■ Select Name

Selects Friendly Name from the list.

Current Friendly Name / AV Room / Bedroom / Dining Room / Family Room / Guest Room / Kids Room / Kitchen / Living Room / Office / Marantz M-CR511 / Other (Default :Marantz M-CR511)

- When you select “Other”, you can change the Friendly Name according to your preferences.



- Up to 63 characters can be input.
- For character input, see [\(p. 75\)](#).

Wi-Fi

You can stop the Wi-Fi function when connecting this unit to the network using Wired LAN.

| | |
|------------------------------|--------------------------------|
| Enabled (Default): | The Wi-Fi function is used. |
| Disabled: | The Wi-Fi function is stopped. |

Bluetooth

You can stop the Bluetooth function.

| | |
|------------------------------|------------------------------------|
| Enabled (Default): | The Bluetooth function is used. |
| Disabled: | The Bluetooth function is stopped. |



Settings

You can make detailed settings for the network.

To change the network environment, perform “Quick Setup”. (For details on the operations, see the separate “Quick Setup Guide”).

- If you are using a broadband router (DHCP function), there is no need to make the settings at “IP Address” and “Proxy”, since the DHCP function is set to “On” in this unit’s default settings.
- Only set “Settings” when connecting to a network without a DHCP function.

■ Wired Setup

□ DHCP

Selects how to connect to the network.

| | |
|-------------------------|--|
| On (Default): | Configure the network settings automatically from your router. |
| Off: | Configure the network settings manually. |

□ IP Address

Set the IP address within the ranges shown below.

- The Network Audio function cannot be used if other IP addresses are set.

CLASS A: 10.0.0.1 - 10.255.255.254

CLASS B: 172.16.0.1 - 172.31.255.254

CLASS C: 192.168.0.1 - 192.168.255.254

□ Subnet Mask

When connecting an xDSL modem or connector adapter directly to this unit, input the subnet mask indicated in the documentation supplied by your provider. Normally input 255.255.255.0.

□ Gateway

When connected to a gateway (router), input its IP address.

□ Primary DNS, Secondary DNS

If there is only one DNS address indicated in the documentation supplied by your provider, enter it for “Primary DNS”. If two or more DNS are provided by your provider, enter one for “Secondary DNS”.



Proxy

Make this setting when connecting to the Internet via a proxy server. Make the proxy settings only when you connect to the Internet via a proxy server that is on your internal network or provided by your provider, etc.

| | |
|---|---|
| Proxy (Off) or Proxy (On): | Set the proxy server. |
| Proxy (Address) or Proxy (Name): | Select when inputting by address or domain name. |
| Address or Name: | Inputting address or domain name. Up to 38 characters can be input. |
| Port: | Enter port number. |



- If you cannot connect to the Internet, recheck the connections and settings. (🔗 p. 24)
- If you do not understand about Internet connection, contact your ISP (Internet Service Provider) or the store from which you purchased your computer.

Wi-Fi Setup Method

In this menu, Wi-Fi settings and connections can be made using any of the five connection methods.

Auto-Scan /Share Wi-Fi setting from an iOS device / WPS (Wi-Fi Protected Setup) / Web Browser Setup / Manual



- If a LAN cable is connected, remove it.
- See the Quick Setup Guide for details on how to connect to Wi-Fi using the Wi-Fi CONNECT button on the rear panel.



❑ Auto-Scan

This automatically searches for networks.

1 From the list of the networks, select the one you want to connect to.

- Select “Rescan” if the network cannot be found.

2 Make the following settings.

| | |
|-------------------------|--|
| Default Key: | Select the default key. <ul style="list-style-type: none"> • When connecting to a WEP encrypted network, “Default Key” menu is displayed. |
| Password: | Input the password. |
| DHCP/Proxy: | Performs the DHCP and proxy setting. (“DHCP” (🔗 p. 86), “Proxy” (🔗 p. 87)) |
| Test Connection: | Test the connection. |

❑ Share Wi-Fi setting from an iOS device

You can use an iOS device such as an iPhone or iPad to configure Wi-Fi settings.

After selecting this item, select Settings/Wi-Fi from the iOS device home screen, select “Marantz M-CR511” displayed at the bottom of the screen, and then follow the setting instructions displayed on the iOS device.

For details, see the “Quick Setup Guide”.



- The iOS version must be 7 or later.

❑ WPS (Wi-Fi Protected Setup)

1 Register the PIN code of the unit in the router.



Web Browser Setup

Use a web browser to set up Wi-Fi.

A Wi-Fi device that can perform web browse operations is required.

1 Read the precautions on the screen, and press ENTER.

2 Select “Marantz M-CR511” from the Wi-Fi network list of the Wi-Fi device.

The IP address (192.168.1.16) appears on the unit.

3 Enter the IP address of this unit in browser’s address box.

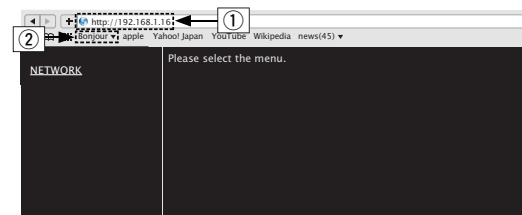

- ① Entering the IP address (192.168.1.16).
- ② If you are using the Safari web browser, you can select “Bonjour” and directly access the unit’s web control screen from the overview section.

4 When the top menu is displayed, click “NETWORK”.

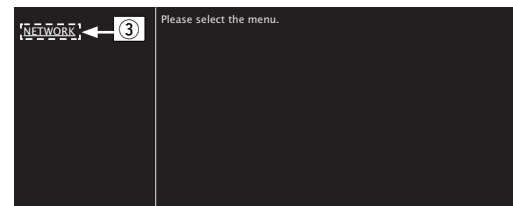

- ③ Click “NETWORK”. (Example 1)



5 Operate.

[Example 1] Network Setting 1

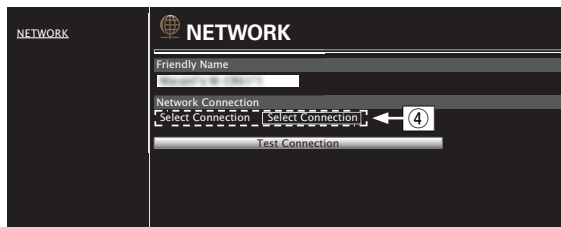

□ Network connection settings

- ④ Click to change the network connection method. If you select “Wi-Fi”, a new item will appear on-screen.
 (👉 [Example 2])

[Example 2] Network Setting 2

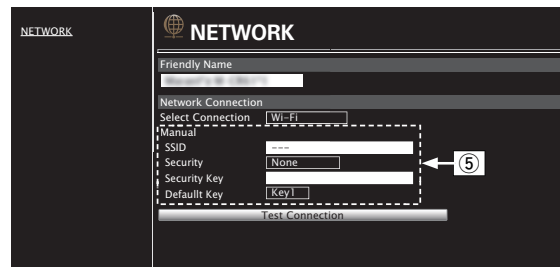

□ Network connection settings

- ⑤ [Example 2] - Displayed when “Wi-Fi” is selected in ④. Select or input items as necessary, and then click “Test Connection” to apply the changes.
- Items displayed may vary depending on selected items and connection status.
 - After selecting each item, wait a moment for the display to be updated.
- ✎
- To apply network connection settings, click “Test Connection” after making changes.



❑ Manual

Sets the wireless connection manually

| | |
|-------------------------|--|
| SSID : | Input the name of the wireless network (SSID). |
| Security: | Select the encryption method according to the encryption setting of the access point you are using. |
| Default Key: | Select the Default Key. <ul style="list-style-type: none">• When connecting to a “WEP” encrypted network, “Default Key” menu is displayed. |
| Password: | Input the password. |
| DHCP/Proxy: | Performs the DHCP and proxy setting. (“DHCP” (🔗 p. 86), “Proxy” (🔗 p. 87)) |
| Test Connection: | Test the connection. |



■ Contents

Tips

| | |
|--|----|
| Simple operations in the power off state | 93 |
| Simple operations for iPod/USB | 93 |
| I only want to recharge my iPod | 93 |
| Specifying the iPod track with the alarm function | 93 |
| Specifying the desired track with the alarm function | 93 |
| Change to summer time | 93 |
| Changing or resetting the network environment | 94 |
| Volume adjustment is difficult when using AirPlay or app operation, and the sound suddenly becomes too loud | 94 |
| I want to set the optimized listening environment after changing the configuration/position of the speakers or changing a speaker to a new one | 94 |

Troubleshooting

| | |
|---|-----|
| Power does not turn on / Power is turned off | 95 |
| LED is flashing | 95 |
| Operations cannot be performed through the remote control unit | 96 |
| Display on this unit shows nothing | 96 |
| No sound comes out | 97 |
| Desired sound does not come out | 98 |
| Sound is interrupted or noise occurs | 99 |
| iPod cannot be played back | 100 |
| USB memory devices cannot be played back | 101 |
| Bluetooth cannot be played back | 102 |
| File names on the iPod/USB memory device are not displayed properly | 103 |
| The Internet radio cannot be played back | 104 |
| Music files on PC or NAS cannot be played back | 105 |
| Cannot connect by Wi-Fi | 106 |



Tips

Simple operations in the power off state

- When a input source select buttons, ►/|| button or FAVORITES CALL button is pressed, the operation is performed at the same time as the unit switches on. (“Basic operation” (🔍 p. 29), “Favorite function” (🔍 p. 39))
- When the “Network Control” is set to “On”, you can perform playback, or other operations through AirPlay, “Marantz Hi-Fi Remote”. (🔍 p. 84)

Simple operations for iPod/USB

- When connected to the Front USB port, the Input Source automatically changes and playback begins. (“Listening to music on an iPod” (🔍 p. 42), “Playing files stored on USB memory devices” (🔍 p. 46))

I only want to recharge my iPod

- Connect the iPod to this unit when the unit power is on. Then turn the unit power off, and the iPod will continue to charge until fully charged. (🔍 p. 44)
- When connected to the Rear USB port, the iPod can be charged without the current Input Source changing.

Specifying the iPod track with the alarm function

- Connect the iPod to this unit by USB and then press the MODE button to register your favorite tracks in the favorites using “On-Display” mode. (🔍 p. 39) Then set a track registered in the favorites as the alarm. (🔍 p. 77)
- When using alarm playback on an iPod touch or iPhone, set the iPod touch or iPhone to “Sleep” mode. If the power is switched off using the power off operation, alarm playback cannot be used.

Specifying the desired track with the alarm function

- After registering the desired track in NAS, etc., register the track in the favorites and then specify the track in the alarm settings. (🔍 p. 77)

Change to summer time

- Select “General” - “Clock” in the setup menu and configure the settings. (🔍 p. 78)



Changing or resetting the network environment

- Prepare the provided Quick Setup Guide, and run Setup – “Quick Setup”. For detailed settings, run Setup - “Network” - Settings. (🔍 p. 86)

Volume adjustment is difficult when using AirPlay or app operation, and the sound suddenly becomes too loud

- Reducing the “Volume Limit” setting value (to around 20 to 30) limits the volume setting from AirPlay or an app to an ideal range and makes it easier to adjust the volume. (🔍 p. 79)

I want to set the optimized listening environment after changing the configuration/position of the speakers or changing a speaker to a new one

- Select Setup – “General” – “Speaker Response” and configure the settings. (🔍 p. 79)



Troubleshooting

1. Are the connections correct?
2. Is the set being operated as described in the owner's manual?
3. Are the other devices operating properly?

If this unit does not operate properly, check the items listed in the table below.

Should the problem persist, there may be a malfunction. In this case, disconnect the power immediately and contact your store of purchase.

■ Power does not turn on / Power is turned off

| Symptom | Cause / Solution | Page |
|--------------------------------|---|-----------|
| Power does not turn on. | <ul style="list-style-type: none"> • Check whether the power plug is correctly inserted into the power outlet. | <u>27</u> |
| Power automatically turns off. | <ul style="list-style-type: none"> • The sleep timer is set. Turn on the power again. | <u>69</u> |
| | <ul style="list-style-type: none"> • "Auto-Standby" is set. "Auto-Standby" is triggered when there is no operation for a set amount of time. To disable "Auto-Standby", set "Auto-Standby" on the menu to "Off". | <u>80</u> |

■ LED is flashing

| Symptom | Cause / Solution | Page |
|---------------|---|-----------|
| Flashing red. | <ul style="list-style-type: none"> • The amplifier circuit in the unit has malfunctioned. Disconnect the power and contact the repair center. | — |
| | <ul style="list-style-type: none"> • The clock is incorrect because the AC was temporarily switched off, etc. Check the network connection and adjust the clock. | <u>78</u> |



■ Operations cannot be performed through the remote control unit

| Symptom | Cause / Solution | Page |
|---|--|----------|
| Operations cannot be performed through the remote control unit. | • Batteries are worn out. Replace with new batteries. | <u>7</u> |
| | • Operate the remote control unit within a distance of about 7 m from this unit and at an angle of within 30°. | <u>7</u> |
| | • Remove any obstacle between this unit and the remote control unit. | — |
| | • Insert the batteries in the proper direction, checking the ⊕ and ⊖ marks. | <u>7</u> |
| | • The set's remote control sensor is exposed to strong light (direct sunlight, inverter type fluorescent bulb light, etc.). Move the set to a place in which the remote control sensor will not be exposed to strong light. | — |
| | • When using a 3D video device, the remote control unit of this unit may not function due to effects of infrared communications between units (such as TV and glasses for 3D viewing). In this case, adjust the direction of units with the 3D communications function and their distance to ensure they do not affect operations from the remote control unit of this unit. | — |

■ Display on this unit shows nothing

| Symptom | Cause / Solution | Page |
|-----------------|--|-----------|
| Display is off. | • Press the DIMMER button on the remote control to set any setting other than OFF. | <u>70</u> |



■ No sound comes out

| Symptom | Cause / Solution | Page |
|---|--|-----------|
| No sound comes out of speakers. | • Check the connections for all devices. | <u>18</u> |
| | • Insert connection cables all the way in. | — |
| | • Check that input connectors and output connectors are not reversely connected. | — |
| | • Check cables for damage. | — |
| | • Check that speaker cables are properly connected. Check that cable core wires come in contact with the metal part on speaker terminals. Also, securely tighten speaker terminals. Check speaker terminals for looseness. | <u>18</u> |
| | • Check that a proper input source is selected. | <u>29</u> |
| | • Adjust the volume. | <u>30</u> |
| | • Cancel the mute mode. | <u>30</u> |
| | • Check that the correct input source is selected when audio is being input to this unit from an external device. | <u>53</u> |
| | • Check the digital audio output setting on the connected device. The initial settings may be off depending on the device. | <u>53</u> |
| | • Only 2-channel linear PCM can be input as the digital audio signal to the DIGITAL IN connector of this unit. | <u>53</u> |
| • No sound is output from the speakers when headphones are connected. | <u>11</u> | |



■ Desired sound does not come out

| Symptom | Cause / Solution | Page |
|--|--|-----------|
| Left/right volume balance is unbalanced. | <ul style="list-style-type: none"> Press the DBB/TONE button on the remote control to adjust the balance. | <u>68</u> |
| No sound from the sub woofer. | <ul style="list-style-type: none"> Check the subwoofer connections. | <u>19</u> |
| | <ul style="list-style-type: none"> Switch the subwoofer power on. | — |
| Set values are not reflected in “Dynamic Bass Boost”, “Bass” and “Treble”. | <ul style="list-style-type: none"> “Dynamic Bass Boost”, “Bass” and “Treble” setting values are not reflected in subwoofer out. | <u>68</u> |





■ Sound is interrupted or noise occurs

| Symptom | Cause / Solution | Page |
|--|--|-----------|
| During playback from the Internet radio or USB memory device, sound is occasionally interrupted. | • When the transfer speed of the USB memory device is slow, sound may occasionally be interrupted. | — |
| | • The network communication speed is slow or the radio station is busy. | — |
| When making a call on iPhone, noise occurs in audio output on this unit. | • When making a call, keep a distance of 20 cm or longer between iPhone and this unit. | — |
| Sound cuts out when using Wi-Fi connection. | • If nearby devices cause playback to cut out due to electronic interference, switch to a wired LAN connection. | <u>24</u> |
| | • Particularly when you play back large music files, depending on your wireless LAN environment, the playback sound may be interrupted. In this case, make the wired LAN connection. | <u>86</u> |



■ iPod cannot be played back

| Symptom | Cause / Solution | Page |
|---|---|--------------------|
| iPod cannot be connected. | • When using iPod by connecting it to the USB port, some iPod variations are not supported. | 23 |
| | • When iPod is connected by using a USB cable other than the genuine cable, iPod may not be recognized. Use a genuine USB cable. | — |
| The AirPlay icon  is not displayed on iTunes / iPhone / iPod touch / iPad. | • This unit and PC / iPhone / iPod touch / iPad are not connected to the same network (LAN). Connect it to the same LAN as this unit. | 24 |
| | • The firmware on iTunes / iPhone / iPod touch / iPad is not compatible with AirPlay. Update the firmware to the latest version. | — |
| No sound is produced. | • The volume on iTunes / iPhone / iPod touch / iPad is set to the minimum level. The volume on iTunes / iPhone / iPod touch / iPad is linked with the volume on this unit. Set a proper volume level. | — |
| | • The AirPlay playback is not performed, or this unit is not selected. Click the AirPlay icon  on the iTunes / iPhone / iPod touch / iPad screen and select this unit. | 54 |
| Audio is interrupted during the AirPlay playback on iPhone / iPod touch / iPad. | • Quit the application running in the background of the iPhone/iPod touch/iPad, and then play using AirPlay. | — |
| | • Some external factors may be affecting the wireless connection. Modify the network environment by taking measures such as shortening the distance from the wireless LAN access point. | — |



■ USB memory devices cannot be played back

| Symptom | Cause / Solution | Page |
|---|--|--------------------|
| "No Connection" is displayed. | • The set cannot recognize a USB memory device. Disconnect and reconnect the USB memory device. | 22 |
| | • USB memory devices of a mass storage class or those compatible with MTP are supported. | — |
| | • This unit does not support a connection through a USB hub. Connect the USB memory device directly to the USB port. | — |
| | • The USB memory device must be formatted to FAT16 or FAT32. | — |
| | • Not all USB memory devices are guaranteed to work. Some USB memory devices are not recognized. When using a type of portable hard disc drive compatible with the USB connection that requires power from an AC adapter, use the AC adapter that came with the drive. | — |
| Files on the USB memory device are not displayed. | • Files of a type not supported by this unit are not displayed. | 45 |
| | • This unit can display a file structure with up to 8 levels and up to 5000 subfolders and files in total. Modify the folder structure of the USB memory device. | — |
| | • When multiple partitions exist on the USB memory device, only files on the first partition are displayed. | — |
| Files on a USB memory device cannot be played. | • Files are created in a format that is not supported by this unit. Check the formats supported by this unit. | 45 |
| | • You are attempting to play a file that is copyright protected. Files that are copyright protected cannot be played on this unit. | — |



■ Bluetooth cannot be played back

| Symptom | Cause / Solution | Page |
|---|---|--------------------|
| Bluetooth devices cannot be connected to this unit. | • The Bluetooth function in the Bluetooth device has not been enabled. See the Owner's Manual of the Bluetooth device to enable the Bluetooth function. | — |
| | • Bring the Bluetooth device near to this unit. | — |
| | • The Bluetooth device cannot connect with this unit if it is not compatible with the A2DP profile. | — |
| | • Turn the power of the Bluetooth device off and on again, and then try again. | — |
| | • Set "Network Control" to "On" and connect again. | 84 |
| NFC connection fails | • Check the NFC settings on each Bluetooth device. | — |
| | • Cancel the Lock function on each Bluetooth device. | — |
| | • Check the NFC position on each Bluetooth device, and then move the NFC close to  on this unit. | 51 |
| | • Set "Network Control" to "On" and connect again. | 84 |
| The sound is cut off. | • Bring the Bluetooth device near to this unit. | — |
| | • Remove obstructions between the Bluetooth device and this unit. | — |
| | • To prevent electromagnetic interference, locate this unit away from microwave ovens, wireless LAN devices and other Bluetooth devices. | — |
| | • Reconnect the Bluetooth device. | — |



■ File names on the iPod/USB memory device are not displayed properly

| Symptom | Cause / Solution | Page |
|--|--|------|
| The file names are not displayed properly (“...”, etc.). | <ul style="list-style-type: none">Characters that cannot be displayed are used. This is not a malfunction. On this unit, characters that cannot be displayed are replaced with a “.” (period). | — |



■ The Internet radio cannot be played back

| Symptom | Cause / Solution | Page |
|---|--|------------|
| The radio station list is not displayed. | <ul style="list-style-type: none"> The LAN cable is not properly connected, or the network is disconnected. Check the connection status. | <u>24</u> |
| Internet Radio cannot be played. | <ul style="list-style-type: none"> The selected radio station is broadcasting in a format that is not supported by this unit. Formats that can be played back in this unit are MP3, WMA and AAC. | <u>109</u> |
| | <ul style="list-style-type: none"> The firewall function is enabled on the router. Check the firewall setting. | — |
| | <ul style="list-style-type: none"> The IP address is not properly set. | <u>86</u> |
| | <ul style="list-style-type: none"> Check the power of the router is on. | — |
| | <ul style="list-style-type: none"> To obtain the IP address automatically, enable the DHCP server function on the router. Also, set the “DHCP” setting to “On” on this unit. | <u>86</u> |
| | <ul style="list-style-type: none"> To obtain the IP address manually, set the IP address and proxy on this unit. | <u>86</u> |
| Cannot connect to favorite radio stations. | <ul style="list-style-type: none"> Some radio stations broadcast silently during some time period. In this case, no audio is output. Wait for a while and select the same radio station, or select another radio station. | <u>32</u> |
| | <ul style="list-style-type: none"> Radio station is not currently in service. Register radio stations in service. | — |
| For some radio stations, “Connection Down” is displayed and station cannot be connected to. | <ul style="list-style-type: none"> The selected radio station is not in service. Select a radio station in service. | — |



■ Music files on PC or NAS cannot be played back

| Symptom | Cause / Solution | Page |
|--|--|---------------------|
| Files stored on a computer cannot be played. | • Files are stored in a non-compatible format. Record in a compatible format. | 110 |
| | • You are attempting to play a file that is copyright protected. Files that are copyright protected cannot be played on this unit. | — |
| | • The set's USB port cannot be used for connection to a computer. | — |
| | • Media sharing settings are not correct. Change media sharing settings so that the unit can access the folders on your computer. | 36 |
| Server is not found, or it is not possible to connect to the server. | • The computer's or router's firewall is activated. Check the computer's or router's firewall settings. | — |
| | • Computer's power is not turned on. Turn on the power. | — |
| | • Server is not running. Launch the server. | — |
| | • Set's IP address is wrong. Check the set's IP address. | 84 |
| Music files on PC cannot be played back. | • Even if PC is connected to the USB port on this unit, music files on it cannot be played back. Connect PC to this unit through the network. | 24 |
| Files on PC or NAS are not displayed. | • Files of a type not supported by this unit are not displayed. | 110 |
| Music stored on a NAS cannot be played. | • If you use a NAS in conformity with the DLNA standard, enable the DLNA server function in the NAS setting. | — |
| | • If you use a NAS that does not conform with the DLNA standard, play the music via a PC. Set Windows Media Player's media sharing function and add NAS to the selected play folder. | 36 |
| | • If connection is restricted, set audio equipment as the connection target. | — |



■ Cannot connect by Wi-Fi

| Symptom | Cause / Solution | Page |
|---|--|--------------------|
| Cannot connect to the network. | <ul style="list-style-type: none"> The network name and password (WEP, etc.) settings are wrong. Configure the network settings according to the setting details of this unit. | 90 |
| | <ul style="list-style-type: none"> Reduce the distance between the wireless LAN access point and this unit, remove any obstructions and make sure the view to the access point is unobstructed before trying to connect again. Also, install microwave ovens and other network access points as far away as possible. | — |
| | <ul style="list-style-type: none"> Check the router power supply. | — |
| | <ul style="list-style-type: none"> This unit supports IEEE802.11.b/g/n. | — |
| | <ul style="list-style-type: none"> Configure the access point channel settings away from channels that are being used by other networks. | — |
| | <ul style="list-style-type: none"> This unit is not compatible with WEP (TSN). | — |
| Cannot connect to WPS. | <ul style="list-style-type: none"> Check that the WPS mode of the router is operating. | — |
| | <ul style="list-style-type: none"> Press and hold the Wi-Fi CONNECT button (WPS) on this unit for approx. 3 seconds within 2 minutes of operating the router. | — |
| | <ul style="list-style-type: none"> A router/settings that are compatible with WPS 2.0 standards are required. Set the encryption time to “None”, “WPA-PSK (AES)” or “WPA2-PSK (AES)”. | 86 |
| | <ul style="list-style-type: none"> If the router encryption method is WEP/WPA-TKIP/WPA2-TKIP, you cannot connect by using the Wi-Fi CONNECT/WPS button. In this case, use the “Auto-Scan” or “Manual” method to connect. | 91 |
| Cannot connect to the network using iPhone/iPod touch/iPad. | <ul style="list-style-type: none"> Update the iPhone/iPod touch/iPad firmware to the latest version. | — |
| | <ul style="list-style-type: none"> When using a USB cable to configure the settings, the iOS device firmware version needs to support iOS 5 or later. When configuring the settings via a wireless connection, iOS 7 or later needs to be supported. | — |



Playing back USB memory devices

- This unit is compatible with MP3 ID3-Tag (Ver. 2) standard.
- This unit is compatible with WMA META tags.
- If the image size of an album artwork exceeds 600 kB, then music may not be played back properly.

Compatible formats

| | Sampling frequency | Bit rate | Bit length | Extension |
|--------------|--|---------------|------------|------------------------|
| WMA*1 | 32/44.1/48 kHz | 48 – 192 kbps | – | .wma |
| MP3 | 32/44.1/48 kHz | 32 – 320 kbps | – | .mp3 |
| WAV | 32/44.1/48/ 88.2/96/176.4/ 192 kHz | – | 16/24 bits | .wav |
| MPEG-4 AAC*2 | 32/44.1/48 kHz | 16 – 320 kbps | – | .aac/ .m4a/ .mp4 |
| FLAC | 32/44.1/48/ 88.2/96/176.4/ 192 kHz | – | 16/24 bits | .flac |
| ALAC*3 | 32/44.1/48/ 88.2/96kHz | – | 16/24 bits | .m4a |
| AIFF | 32/44.1/48/ 88.2/96/176.4/ 192 kHz | – | 16/24 bits | .aif/ .aiff |



- *1 Copyright-protected files can be played on certain portable players compatible with MTP.
- *2 Only files that are not protected by copyright can be played on this unit. Content downloaded from pay sites on the Internet are copyright protected. Also, files encoded in WMA format when ripped from a CD, etc. on a computer may be copyright protected, depending on the computer's settings.
- *3 Copyright [2012] [D&M Holdings. Inc.] Licensed under the Apache License, Version 2.0 (the "License"); you may not use this file except in compliance with the License. You may obtain a copy of the License at <http://www.apache.org/licenses/LICENSE-2.0>

■ Maximum Number of Playable Files and Folder

The limits on the number of folders and files that can be displayed by this unit are as follows.

| Media | USB memory device |
|--------------------------------------|----------------------------|
| Item | |
| Memory capacity | FAT16 : 2 GB, FAT32 : 2 TB |
| Number of folder directory levels *1 | 8 levels |
| Number of folders | 500 |
| Number of files*2 | 5000 |

*1 The limited number includes the root folder.

*2 The allowable number of files may differ according to the USB memory device capacity and the file size.



Playing back Internet Radio

■ Playable broadcast station specifications

| | Sampling frequency | Bit rate | Extension |
|------------|--------------------|---------------|------------------------|
| WMA | 32/44.1/48 kHz | 48 – 192 kbps | .wma |
| MP3 | 32/44.1/48 kHz | 32 – 320 kbps | .mp3 |
| MPEG-4 AAC | 32/44.1/48 kHz | 16 – 320 kbps | .aac/ .m4a/ .mp4 |

Playing back Bluetooth devices

This unit supports the following Bluetooth profiles.

- A2DP (Advanced Audio Distribution Profile) :
When a Bluetooth device that supports this specification is connected, you can perform high quality streaming distribution of monaural and stereo audio data.
- AVRCP (Audio/Video Remote Control Profile) :
When a Bluetooth device that supports this specification is connected, you can operate the Bluetooth device from this unit.

Bluetooth communications

The radio waves broadcast from this unit may interfere with operations on medical equipment. The radio wave interference may cause a malfunction. Therefore, make sure to turn off power to this unit and Bluetooth devices in the following places.

- Hospitals, trains, airplanes, gas stands, and other places where flammable gas may occur.
- Places near automatic doors and fire alarms.



Playing back files stored on PC or NAS

- This unit is compatible with MP3 ID3-Tag (Ver. 2) standard.
- This unit is compatible with WMA META tags.
- If the image size of an album artwork exceeds 600 kB, then music may not be played back properly.
- A server or server software compatible with distribution in the corresponding formats is required to play music files via a network.



- Particularly when you play back large music files, depending on your wireless LAN environment, the playback sound may be interrupted. In this case, make the wired LAN connection.

■ Playback file specifications

| | Sampling frequency | Bit rate | Bit length | Extension |
|--------------|--|---------------|------------|------------------------|
| WMA | 32/44.1/48 kHz | 48 – 192 kbps | – | .wma |
| MP3 | 32/44.1/48 kHz | 32 – 320 kbps | – | .mp3 |
| WAV | 32/44.1/48/ 88.2/96/176.4/ 192 kHz | – | 16/24 bits | .wav |
| MPEG-4 AAC*1 | 32/44.1/48 kHz | 16 – 320 kbps | – | .aac/ .m4a/ .mp4 |
| FLAC | 32/44.1/48/ 88.2/96/176.4/ 192 kHz | – | 16/24 bits | .flac |
| ALAC*2 | 32/44.1/48/ 88.2/96kHz | – | 16/24 bits | .m4a |
| AIFF | 32/44.1/48/ 88.2/96/176.4/ 192 kHz | – | 16/24 bits | .aif/ .aiff |



- *1 Only files that are not protected by copyright can be played on this unit. Content downloaded from pay sites on the Internet are copyright protected. Also, files encoded in WMA format when ripped from a CD, etc. on a computer may be copyright protected, depending on the computer's settings.
- *2 Copyright [2012] [D&M Holdings. Inc.] Licensed under the Apache License, Version 2.0 (the "License"); you may not use this file except in compliance with the License. You may obtain a copy of the License at <http://www.apache.org/licenses/LICENSE-2.0>

Last function memory

This stores the settings as they were immediately before going into the standby mode.

When the power is turned back on, the settings are restored to as they were immediately before going into the standby mode.



Explanation of terms

■ Audio

ALAC (Apple Lossless Audio Codec)

This is a codec for lossless audio compression method developed by Apple Inc. This codec can be played back on iTunes, iPod or iPhone. Data compressed to approximately 60 – 70% can be decompressed to exactly the same original data.

AIFF (Audio Interchange File Format)

This is an uncompressed and lossless format for digital audio. Use AIFF files to burn high-quality audio CDs from imported songs. AIFF files use approximately 10 MB of disk space per minute.

FLAC

FLAC stands for Free lossless Audio Codec, and is a lossless free audio file format. Lossless means that the audio is compressed without any loss in quality.

The FLAC license is as shown below.

Copyright (C) 2000, 2001, 2002, 2003, 2004, 2005, 2006, 2007, 2008, 2009 Josh Coalson

Redistribution and use in source and binary forms, with or without modification, are permitted provided that the following conditions are met:

- Redistributions of source code must retain the above copyright notice, this list of conditions and the following disclaimer.
- Redistributions in binary form must reproduce the above copyright notice, this list of conditions and the following disclaimer in the documentation and/or other materials provided with the distribution.
- Neither the name of the Xiph.org Foundation nor the names of its contributors may be used to endorse or promote products derived from this software without specific prior written permission.



THIS SOFTWARE IS PROVIDED BY THE COPYRIGHT HOLDERS AND CONTRIBUTORS "AS IS" AND ANY EXPRESS OR IMPLIED WARRANTIES, INCLUDING, BUT NOT LIMITED TO, THE IMPLIED WARRANTIES OF MERCHANTABILITY AND FITNESS FOR A PARTICULAR PURPOSE ARE DISCLAIMED. IN NO EVENT SHALL THE FOUNDATION OR CONTRIBUTORS BE LIABLE FOR ANY DIRECT, INDIRECT, INCIDENTAL, SPECIAL, EXEMPLARY, OR CONSEQUENTIAL DAMAGES (INCLUDING, BUT NOT LIMITED TO, PROCUREMENT OF SUBSTITUTE GOODS OR SERVICES; LOSS OF USE, DATA, OR PROFITS; OR BUSINESS INTERRUPTION) HOWEVER CAUSED AND ON ANY THEORY OF LIABILITY, WHETHER IN CONTRACT, STRICT LIABILITY, OR TORT (INCLUDING NEGLIGENCE OR OTHERWISE) ARISING IN ANY WAY OUT OF THE USE OF THIS SOFTWARE, EVEN IF ADVISED OF THE POSSIBILITY OF SUCH DAMAGE.

MP3 (MPEG Audio Layer-3)

This is an internationally standardized audio data compression scheme, using the "MPEG-1" video compression standard. It compresses the data volume to about one eleventh its original size while maintaining sound quality equivalent to a music CD.

MPEG (Moving Picture Experts Group), MPEG-2, MPEG-4

These are the names for digital compression format standards used for the encoding of video and audio. Video standards include "MPEG-1 Video", "MPEG-2 Video", "MPEG-4 Visual", "MPEG-4 AVC". Audio standards include "MPEG-1 Audio", "MPEG-2 Audio", "MPEG-4 AAC".

WMA (Windows Media Audio)

This is audio compression technology developed by Microsoft Corporation.

WMA data can be encoded using Windows Media® Player. To encode WMA files, only use applications authorized by Microsoft Corporation. If you use an unauthorized application, the file may not work properly.



Sampling frequency

Sampling involves taking a reading of a sound wave (analog signal) at regular intervals and expressing the height of the wave at each reading in digitized format (producing a digital signal).

The number of readings taken in one second is called the “sampling frequency”. The larger the value, the closer the reproduced sound is to the original.

Speaker impedance

This is an AC resistance value, indicated in Ω (Ohms). Greater power can be obtained when this value is smaller.

Bit rate

This expresses the read amount per 1 second of video/audio data recorded. A larger number means higher sound quality, but also means a larger file size.

■ Network**AirPlay**

AirPlay sends (plays) contents recorded in iTunes or on an iPhone/iPod touch/iPad to a compatible device via the network.

DLNA

DLNA and DLNA CERTIFIED are trademarks and/or service marks of Digital Living Network Alliance. Some contents may not be compatible with other DLNA CERTIFIED® products.



vTuner

This is a free online content server for Internet Radio. For inquiries about this service, visit the vTuner site below.

vTuner website:

<http://www.radiomarantz.com>

This product is protected by certain intellectual property rights of Nothing Else Matters Software and BridgeCo. Use or distribution of such technology outside of this product is prohibited without a license from Nothing Else Matters Software and BridgeCo or an authorized subsidiary.

WEP Key (network key)

This is key information used for encrypting data when conducting data transfer. On this unit, the same WEP key is used for data encryption and decryption, so the same WEP key must be set on both devices in order for communications to be established between them.

Wi-Fi®

Wi-Fi Certification assures tested and proven interoperability by the Wi-Fi Alliance, a group certifying interoperability among wireless LAN devices.

WPA (Wi-Fi Protected Access)

This is a security standard established by the Wi-Fi Alliance. In addition to the conventional SSID (network name) and WEP key (network key), it also uses a user identification function and encrypting protocol for stronger security.

WPA2 (Wi-Fi Protected Access 2)

This is a new version of the WPA established by the Wi-Fi Alliance, compatible with more secure AES encryption.

WPA-PSK/WPA2-PSK (Pre-shared Key)

This is a simple authentication system for mutual authentication when a preset character string matches on the wireless LAN access point and client.

WPS (Wi-Fi Protected Setup)

This is a standard drawn up by the Wi-Fi Alliance to ease the task of setting up wireless LAN connections and configuring security.

Network Names (SSID: Service Set Identifier)

When forming wireless LAN networks, groups are formed to prevent interference, data theft, etc. These groups are based on "SSID (network names)". For enhanced security, a WEP key is set so that communication is unavailable unless both the "SSID" and the WEP key match. This is suitable for constructing a simplified network.



■ Others

Pairing

Pairing (registration) is an operation that is required in order to connect a Bluetooth device to this unit using Bluetooth. When paired, the devices authenticate each other and can connect without mistaken connections occurring.

When using Bluetooth connection for the first time, you need to pair this unit and the Bluetooth device to be connected.

Protection circuit

This is a function to prevent damage to devices within the power supply when an abnormality such as an overload, excess voltage occurs or over temperature for any reason.



Trademark information



"Made for iPod" and "Made for iPhone" mean that an electronic accessory has been designed to connect specifically to iPod, or iPhone, respectively, and has been certified by the developer to meet Apple performance standards.

Apple is not responsible for the operation of this device or its compliance with safety and regulatory standards. Please note that the use of this accessory with iPod, or iPhone, may affect wireless performance.

AirPlay, iPad, iPhone, iPod, iPod classic, iPod nano and iPod touch are trademarks of Apple Inc., registered in the U.S. and other countries.

- Individual users are permitted to use iPhone, iPod, iPod classic, iPod nano and iPod touch for private copy and playback of non-copyrighted contents and contents whose copy and playback is permitted by law. Copyright infringement is prohibited by law.



The N Mark is a trademark or registered trademark of NFC Forum, Inc. in the United States and in other countries.



The Bluetooth® word mark and logos are registered trademarks owned by Bluetooth SIG, Inc. and any use of such marks by D&M Holdings Inc. is under license. Other trademarks and trade names are those of their respective owners.



The Wi-Fi CERTIFIED logo is a registered trademark of the Wi-Fi Alliance.

Wi-Fi Certification provides assurance that the device has passed the interoperability test conducted by the Wi-Fi Alliance, a group that certifies interoperability among wireless LAN devices.

Adobe, the Adobe logo and Reader are either registered trademarks or trademarks of Adobe Systems Incorporated in the United States and/or other countries.



Specifications

■ Audio section

- Audio amplifier

Rated output:

2-channel driving
50 W + 50 W
(6 Ω /ohms, 1 kHz, THD+N 0.7 %)

Dynamic power:

60 W + 60 W
(6 Ω /ohms, 1 kHz, THD+N 10 %)

Output terminals:

Speaker: 4-16 Ω /ohms (impedance)
Compatible with headphones/stereo headphones

Input sensitivity/impedance:

Analog In: 200 mV/22 k Ω /kohms

**Total harmonic distortion
(1 kHz, 5 W, 6 Ω /ohms):**

Analog In: 0.1 %

S/N ratio (10 W, 6 Ω /ohms, IHF-A):

Analog In : 90 dB

Tone control:

Dynamic Bass Boost : +8 dB (100 Hz)
Bass : ± 10 dB (100 Hz)
Treble : ± 10 dB (10 kHz)

Frequency response:

Analog In : 5 Hz – 40 kHz (± 3 dB)



■ Wireless LAN section

| | |
|--|--|
| Network type (wireless LAN standard): | Conforming to IEEE 802.11b Conforming to IEEE 802.11g Conforming to IEEE 802.11n (Wi-Fi® compliant)*1 |
| Security: | WEP 64 bit, WEP 128 bit WPA/WPA2-PSK (AES) WPA/WPA2-PSK (TKIP) |
| Radio frequency: | 2.4 GHz |
| No. of channels: | 1 – 13 ch |

*1 The Wi-Fi® CERTIFIED Logo and the Wi-Fi CERTIFIED On-Product Logo are registered trademarks of the Wi-Fi Alliance.



■ Bluetooth section

| | |
|-------------------------------------|--|
| Communications system: | Bluetooth Version 2.1 + EDR (Enhanced Data Rate) |
| Transmission power: | Maximum 2.5 mW (Class 2) |
| Maximum communication range: | Approx. 10 m in line of sight*2 |
| Frequency band: | 2.4 GHz band |
| Modulation scheme: | FHSS (Frequency-Hopping Spread Spectrum) |
| Supported profiles: | A2DP (Advanced Audio Distribution Profile) 1.2 AVRCP (Audio Video Remote Control Profile) 1.4 |
| Corresponding codec: | SBC, AAC |
| Transmission range (A2DP): | 20 Hz - 20,000 Hz |

*2 The actual communication range varies depending on the influence of such factors as obstructions between devices, electromagnetic waves from microwave ovens, static electricity, cordless phones, reception sensitivity, antenna performance, operating system, application software etc.



■ Clock/Alarm/Sleep

| | |
|--------------------|--|
| Clock type: | Power line frequency synchronized method (Within ± 60 seconds per month) |
| Alarm: | Once alarm/Everyday alarm: One system each |
| Sleep: | Sleep timer: Max. 90 minutes |

■ General

| | |
|--|--------------------------|
| Power supply: | AC 220 - 230 V, 50/60 Hz |
| Power consumption: | 50 W |
| Power consumption in standby mode : | 0.3 W |
| Power consumption in “Clock Mode” – “On” mode: | 1 W |
| Power consumption in “Network Control” – “On” mode: | 3 W |

- For purposes of improvement, specifications and design are subject to change without notice.



■ Dimensions

Unit : mm

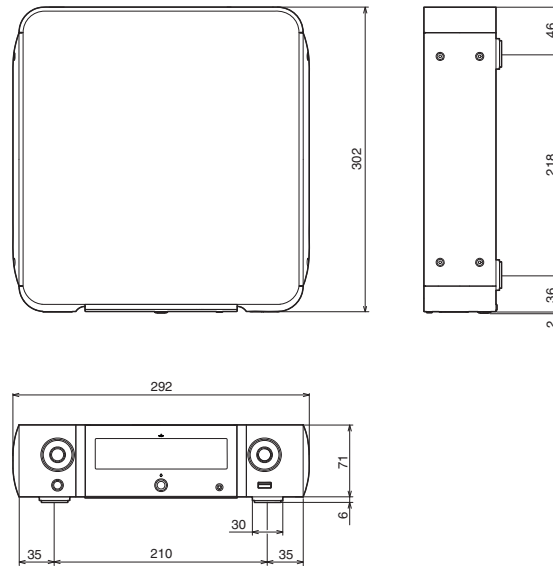

■ Weight : 2.6 kg

Index

| | | | | | |
|----------------------------|-----|----------------------------|------------|----------------------------------|--------|
| A | | I | | R | |
| AirPlay | 54 | Inputting characters | 75 | Random playback | 37, 46 |
| Alarm | 77 | Internet Radio | 31 | Rear panel | 12 |
| B | | iPod | 22, 41, 44 | Remote control unit | 14 |
| Bluetooth device | 47 | M | | Remote play function | 58 |
| D | | Menu map | 71 | Repeat playback | 37, 46 |
| Display's brightness | 70 | Muting | 30 | Resetting factory settings | 83 |
| DLNA | 112 | N | | S | |
| F | | NAS | 35, 110 | Sleep timer | 69 |
| Favorites | 39 | Network settings | 84 | Spotify | 57 |
| Firmware update | 81 | P | | T | |
| Front panel | 9 | PC | 35, 110 | Tone | 68 |
| | | | | U | |
| | | | | USB memory device | 22, 45 |



**V**

| | |
|--------------|----|
| Volume | 30 |
| vTuner | 34 |

**W**

| | |
|----------------------------|----|
| Web control function | 61 |
| Wired LAN | 24 |



License

**This section describes software license used for this unit.
To maintain the correct content, the original (English) is used.**

■ Boost

<http://www.boost.org/>

Boost Software License – Version 1.0 – August 17th, 2003

Permission is hereby granted, free of charge, to any person or organization obtaining a copy of the software and accompanying documentation covered by this license (the “Software”) to use, reproduce, display, distribute, execute, and transmit the Software, and to prepare derivative works of the Software, and to permit third-parties to whom the Software is furnished to do so, all subject to the following:

The copyright notices in the Software and this entire statement, including the above license grant, this restriction and the following disclaimer, must be included in all copies of the Software, in whole or in part, and all derivative works of the Software, unless such copies or derivative works are solely in the form of machine-executable object code generated by a source language processor.

THE SOFTWARE IS PROVIDED “AS IS”, WITHOUT WARRANTY OF ANY KIND, EXPRESS OR IMPLIED, INCLUDING BUT NOT LIMITED TO THE WARRANTIES OF MERCHANTABILITY, FITNESS FOR A PARTICULAR PURPOSE, TITLE AND NON-INFRINGEMENT. IN NO EVENT SHALL THE COPYRIGHT HOLDERS OR ANYONE DISTRIBUTING THE SOFTWARE BE LIABLE FOR ANY DAMAGES OR OTHER LIABILITY, WHETHER IN CONTRACT, TORT OR OTHERWISE, ARISING FROM, OUT OF OR IN CONNECTION WITH THE SOFTWARE OR THE USE OR OTHER DEALINGS IN THE SOFTWARE.

■ Expat

<http://www.jclark.com/xml/expat.html>

Expat License. Copyright (c) 1998, 1999, 2000 Thai Open Source Software Center Ltd

Permission is hereby granted, free of charge, to any person obtaining a copy of this software and associated documentation files (the “Software”), to deal in the Software without restriction, including without limitation the rights to use, copy, modify, merge, publish, distribute, sublicense, and/or sell copies of the Software, and to permit persons to whom the Software is furnished to do so, subject to the following conditions:

The above copyright notice and this permission notice shall be included in all copies or substantial portions of the Software.

THE SOFTWARE IS PROVIDED “AS IS”, WITHOUT WARRANTY OF ANY KIND, EXPRESS OR IMPLIED, INCLUDING BUT NOT LIMITED TO THE WARRANTIES OF MERCHANTABILITY, FITNESS FOR A PARTICULAR PURPOSE AND NON-INFRINGEMENT. IN NO EVENT SHALL THE AUTHORS OR COPYRIGHT HOLDERS BE LIABLE FOR ANY CLAIM, DAMAGES OR OTHER LIABILITY, WHETHER IN AN ACTION OF CONTRACT, TORT OR OTHERWISE, ARISING FROM, OUT OF OR IN CONNECTION WITH THE SOFTWARE OR THE USE OR OTHER DEALINGS IN THE SOFTWARE.

■ FastDelegate

<http://www.codeproject.com/KB/cpp/FastDelegate.aspx>

THE WORK (AS DEFINED BELOW) IS PROVIDED UNDER THE TERMS OF THIS CODE PROJECT OPEN LICENSE (“LICENSE”). THE WORK IS PROTECTED BY COPYRIGHT AND/OR OTHER APPLICABLE LAW. ANY USE OF THE WORK OTHER THAN AS AUTHORIZED UNDER THIS LICENSE OR COPYRIGHT LAW IS PROHIBITED.

BY EXERCISING ANY RIGHTS TO THE WORK PROVIDED HEREIN, YOU ACCEPT AND AGREE TO BE BOUND BY THE TERMS OF THIS LICENSE. THE AUTHOR GRANTS YOU THE RIGHTS CONTAINED HEREIN IN CONSIDERATION OF YOUR ACCEPTANCE OF SUCH TERMS AND CONDITIONS. IF YOU DO NOT AGREE TO ACCEPT AND BE BOUND BY THE TERMS OF THIS LICENSE, YOU CANNOT MAKE ANY USE OF THE WORK.



Definitions. “Articles” means, collectively, all articles written by Author which describes how the Source Code and Executable Files for the Work may be used by a user.

“Author” means the individual or entity that offers the Work under the terms of this License.

“Derivative Work” means a work based upon the Work or upon the Work and other pre-existing works.

“Executable Files” refer to the executables, binary files, configuration and any required data files included in the Work.

“Publisher” means the provider of the website, magazine, CD-ROM, DVD or other medium from or by which the Work is obtained by You.

“Source Code” refers to the collection of source code and configuration files used to create the Executable Files.

“Standard Version” refers to such a Work if it has not been modified, or has been modified in accordance with the consent of the Author, such consent being in the full discretion of the Author.

“Work” refers to the collection of files distributed by the Publisher, including the Source Code, Executable Files, binaries, data files, documentation, whitepapers and the Articles.

“You” is you, an individual or entity wishing to use the Work and exercise your rights under this License.

Fair Use/Fair Use Rights. Nothing in this License is intended to reduce, limit, or restrict any rights arising from fair use, fair dealing, first sale or other limitations on the exclusive rights of the copyright owner under copyright law or other applicable laws.

License Grant. Subject to the terms and conditions of this License, the Author hereby grants You a worldwide, royalty-free, non-exclusive, perpetual (for the duration of the applicable copyright) license to exercise the rights in the Work as stated below: You may use the standard version of the Source Code or Executable Files in Your own applications.

You may apply bug fixes, portability fixes and other modifications obtained from the Public Domain or from the Author. A Work modified in such a way shall still be considered the standard version and will be subject to this License.

You may otherwise modify Your copy of this Work (excluding the Articles) in any way to create a Derivative Work, provided that You insert a prominent notice in each changed file stating how, when and where You changed that file.

You may distribute the standard version of the Executable Files and Source Code or Derivative Work in aggregate with other (possibly commercial) programs as part of a larger (possibly commercial) software distribution.

The Articles discussing the Work published in any form by the author may not be distributed or republished without the Author’s consent. The author retains copyright to any such Articles. You may use the Executable Files and Source Code pursuant to this License but you may not repost or republish or otherwise distribute or make available the Articles, without the prior written consent of the Author.

Any subroutines or modules supplied by You and linked into the Source Code or Executable Files this Work shall not be considered part of this Work and will not be subject to the terms of this License.

Patent License. Subject to the terms and conditions of this License, each Author hereby grants to You a perpetual, worldwide, non-exclusive, no-charge, royalty-free, irrevocable (except as stated in this section) patent license to make, have made, use, import, and otherwise transfer the Work.

Restrictions. The license granted in Section 3 above is expressly made subject to and limited by the following restrictions: You agree not to remove any of the original copyright, patent, trademark, and attribution notices and associated disclaimers that may appear in the Source Code or Executable Files.

You agree not to advertise or in any way imply that this Work is a product of Your own.

The name of the Author may not be used to endorse or promote products derived from the Work without the prior written consent of the Author.

You agree not to sell, lease, or rent any part of the Work. This does not restrict you from including the Work or any part of the Work inside a larger software distribution that itself is being sold. The Work by itself, though, cannot be sold, leased or rented.



You may distribute the Executable Files and Source Code only under the terms of this License, and You must include a copy of, or the Uniform Resource Identifier for, this License with every copy of the Executable Files or Source Code You distribute and ensure that anyone receiving such Executable Files and Source Code agrees that the terms of this License apply to such Executable Files and/or Source Code. You may not offer or impose any terms on the Work that alter or restrict the terms of this License or the recipients' exercise of the rights granted hereunder. You may not sublicense the Work. You must keep intact all notices that refer to this License and to the disclaimer of warranties. You may not distribute the Executable Files or Source Code with any technological measures that control access or use of the Work in a manner inconsistent with the terms of this License.

You agree not to use the Work for illegal, immoral or improper purposes, or on pages containing illegal, immoral or improper material. The Work is subject to applicable export laws. You agree to comply with all such laws and regulations that may apply to the Work after Your receipt of the Work.

Representations, Warranties and Disclaimer. THIS WORK IS PROVIDED "AS IS", "WHERE IS" AND "AS AVAILABLE", WITHOUT ANY EXPRESS OR IMPLIED WARRANTIES OR CONDITIONS OR GUARANTEES. YOU, THE USER, ASSUME ALL RISK IN ITS USE, INCLUDING COPYRIGHT INFRINGEMENT, PATENT INFRINGEMENT, SUITABILITY, ETC. AUTHOR EXPRESSLY DISCLAIMS ALL EXPRESS, IMPLIED OR STATUTORY WARRANTIES OR CONDITIONS, INCLUDING WITHOUT LIMITATION, WARRANTIES OR CONDITIONS OF MERCHANTABILITY, MERCHANTABLE QUALITY OR FITNESS FOR A PARTICULAR PURPOSE, OR ANY WARRANTY OF TITLE OR NON-INFRINGEMENT, OR THAT THE WORK (OR ANY PORTION THEREOF) IS CORRECT, USEFUL, BUG-FREE OR FREE OF VIRUSES. YOU MUST PASS THIS DISCLAIMER ON WHENEVER YOU DISTRIBUTE THE WORK OR DERIVATIVE WORKS.

Indemnity. You agree to defend, indemnify and hold harmless the Author and the Publisher from and against any claims, suits, losses, damages, liabilities, costs, and expenses (including reasonable legal or attorneys' fees) resulting from or relating to any use of the Work by You.

Limitation on Liability. EXCEPT TO THE EXTENT REQUIRED BY APPLICABLE LAW, IN NO EVENT WILL THE AUTHOR OR THE PUBLISHER BE LIABLE TO YOU ON ANY LEGAL THEORY FOR ANY SPECIAL, INCIDENTAL, CONSEQUENTIAL, PUNITIVE OR EXEMPLARY DAMAGES ARISING OUT OF THIS LICENSE OR THE USE OF THE WORK OR OTHERWISE, EVEN IF THE AUTHOR OR THE PUBLISHER HAS BEEN ADVISED OF THE POSSIBILITY OF SUCH DAMAGES.

Termination.

This License and the rights granted hereunder will terminate automatically upon any breach by You of any term of this License. Individuals or entities who have received Derivative Works from You under this License, however, will not have their licenses terminated provided such individuals or entities remain in full compliance with those licenses. Sections 1, 2, 6, 7, 8, 9, 10 and 11 will survive any termination of this License.

If You bring a copyright, trademark, patent or any other infringement claim against any contributor over infringements You claim are made by the Work, your License from such contributor to the Work ends automatically.

Subject to the above terms and conditions, this License is perpetual (for the duration of the applicable copyright in the Work). Notwithstanding the above, the Author reserves the right to release the Work under different license terms or to stop distributing the Work at any time; provided, however that any such election will not serve to withdraw this License (or any other license that has been, or is required to be, granted under the terms of this License), and this License will continue in full force and effect unless terminated as stated above.

Publisher. The parties hereby confirm that the Publisher shall not, under any circumstances, be responsible for and shall not have any liability in respect of the subject matter of this License. The Publisher makes no warranty whatsoever in connection with the Work and shall not be liable to You or any party on any legal theory for any damages whatsoever, including without limitation any general, special, incidental or consequential damages arising in connection to this license. The Publisher reserves the right to cease making the Work available to You at any time without notice

Miscellaneous

This License shall be governed by the laws of the location of the head office of the Author or if the Author is an individual, the laws of location of the principal place of residence of the Author.

If any provision of this License is invalid or unenforceable under applicable law, it shall not affect the validity or enforceability of the remainder of the terms of this License, and without further action by the parties to this License, such provision shall be reformed to the minimum extent necessary to make such provision valid and enforceable.



No term or provision of this License shall be deemed waived and no breach consented to unless such waiver or consent shall be in writing and signed by the party to be charged with such waiver or consent.

This License constitutes the entire agreement between the parties with respect to the Work licensed herein. There are no understandings, agreements or representations with respect to the Work not specified herein. The Author shall not be bound by any additional provisions that may appear in any communication from You. This License may not be modified without the mutual written agreement of the Author and You

libogg

<http://www.xiph.org/ogg/>

Copyright (c) 2002, Xiph.org Foundation

Redistribution and use in source and binary forms, with or without modification, are permitted provided that the following conditions are met:

- Redistributions of source code must retain the above copyright notice, this list of conditions and the following disclaimer.
- Redistributions in binary form must reproduce the above copyright notice, this list of conditions and the following disclaimer in the documentation and/or other materials provided with the distribution.
- Neither the name of the Xiph.org Foundation nor the names of its contributors may be used to endorse or promote products derived from this software without specific prior written permission.

THIS SOFTWARE IS PROVIDED BY THE COPYRIGHT HOLDERS AND CONTRIBUTORS "AS IS" AND ANY EXPRESS OR IMPLIED WARRANTIES, INCLUDING, BUT NOT LIMITED TO, THE IMPLIED WARRANTIES OF MERCHANTABILITY AND FITNESS FOR A PARTICULAR PURPOSE ARE DISCLAIMED. IN NO EVENT SHALL THE FOUNDATION OR CONTRIBUTORS BE LIABLE FOR ANY DIRECT, INDIRECT, INCIDENTAL, SPECIAL, EXEMPLARY, OR CONSEQUENTIAL DAMAGES (INCLUDING, BUT NOT LIMITED TO, PROCUREMENT OF SUBSTITUTE GOODS OR SERVICES; LOSS OF USE, DATA, OR PROFITS; OR BUSINESS INTERRUPTION) HOWEVER CAUSED AND ON ANY THEORY OF LIABILITY, WHETHER IN CONTRACT, STRICT LIABILITY, OR TORT (INCLUDING NEGLIGENCE OR OTHERWISE) ARISING IN ANY WAY OUT OF THE USE OF THIS SOFTWARE, EVEN IF ADVISED OF THE POSSIBILITY OF SUCH DAMAGE.

libvorbis

<http://www.xiph.org/vorbis/>

Copyright (c) 2002-2004 Xiph.org Foundation

Redistribution and use in source and binary forms, with or without modification, are permitted provided that the following conditions are met:

- Redistributions of source code must retain the above copyright notice, this list of conditions and the following disclaimer.
- Redistributions in binary form must reproduce the above copyright notice, this list of conditions and the following disclaimer in the documentation and/or other materials provided with the distribution.
- Neither the name of the Xiph.org Foundation nor the names of its contributors may be used to endorse or promote products derived from this software without specific prior written permission.

THIS SOFTWARE IS PROVIDED BY THE COPYRIGHT HOLDERS AND CONTRIBUTORS "AS IS" AND ANY EXPRESS OR IMPLIED WARRANTIES, INCLUDING, BUT NOT LIMITED TO, THE IMPLIED WARRANTIES OF MERCHANTABILITY AND FITNESS FOR A PARTICULAR PURPOSE ARE DISCLAIMED. IN NO EVENT SHALL THE FOUNDATION OR CONTRIBUTORS BE LIABLE FOR ANY DIRECT, INDIRECT, INCIDENTAL, SPECIAL, EXEMPLARY, OR CONSEQUENTIAL DAMAGES (INCLUDING, BUT NOT LIMITED TO, PROCUREMENT OF SUBSTITUTE GOODS OR SERVICES; LOSS OF USE, DATA, OR PROFITS; OR BUSINESS INTERRUPTION) HOWEVER CAUSED AND ON ANY THEORY OF LIABILITY, WHETHER IN CONTRACT, STRICT LIABILITY, OR TORT (INCLUDING NEGLIGENCE OR OTHERWISE) ARISING IN ANY WAY OUT OF THE USE OF THIS SOFTWARE, EVEN IF ADVISED OF THE POSSIBILITY OF SUCH DAMAGE.

Tremolo

<http://wss.co.uk/pinknoise/tremolo>

Copyright (C) 2002 – 2009 Xiph.org Foundation Changes Copyright (C) 2009 – 2010 Robin Watts for Pinknoise Productions Ltd

Redistribution and use in source and binary forms, with or without modification, are permitted provided that the following conditions are met:



- Redistributions of source code must retain the above copyright notice, this list of conditions and the following disclaimer.
- Redistributions in binary form must reproduce the above copyright notice, this list of conditions and the following disclaimer in the documentation and/or other materials provided with the distribution.
- Neither the name of the Xiph.org Foundation nor the names of its contributors may be used to endorse or promote products derived from this software without specific prior written permission.

THIS SOFTWARE IS PROVIDED BY THE COPYRIGHT HOLDERS AND CONTRIBUTORS "AS IS" AND ANY EXPRESS OR IMPLIED WARRANTIES, INCLUDING, BUT NOT LIMITED TO, THE IMPLIED WARRANTIES OF MERCHANTABILITY AND FITNESS FOR A PARTICULAR PURPOSE ARE DISCLAIMED. IN NO EVENT SHALL THE FOUNDATION OR CONTRIBUTORS BE LIABLE FOR ANY DIRECT, INDIRECT, INCIDENTAL, SPECIAL, EXEMPLARY, OR CONSEQUENTIAL DAMAGES (INCLUDING, BUT NOT LIMITED TO, PROCUREMENT OF SUBSTITUTE GOODS OR SERVICES; LOSS OF USE, DATA, OR PROFITS; OR BUSINESS INTERRUPTION) HOWEVER CAUSED AND ON ANY THEORY OF LIABILITY, WHETHER IN CONTRACT, STRICT LIABILITY, OR TORT (INCLUDING NEGLIGENCE OR OTHERWISE) ARISING IN ANY WAY OUT OF THE USE OF THIS SOFTWARE, EVEN IF ADVISED OF THE POSSIBILITY OF SUCH DAMAGE.

■ Tremor

<http://wiki.xiph.org/index.php/Tremor>

Copyright (c) 2002, Xiph.org Foundation

Redistribution and use in source and binary forms, with or without modification, are permitted provided that the following conditions are met:

- Redistributions of source code must retain the above copyright notice, this list of conditions and the following disclaimer.
- Redistributions in binary form must reproduce the above copyright notice, this list of conditions and the following disclaimer in the documentation and/or other materials provided with the distribution.
- Neither the name of the Xiph.org Foundation nor the names of its contributors may be used to endorse or promote products derived from this software without specific prior written permission.

THIS SOFTWARE IS PROVIDED BY THE COPYRIGHT HOLDERS AND CONTRIBUTORS "AS IS" AND ANY EXPRESS OR IMPLIED WARRANTIES, INCLUDING, BUT NOT LIMITED TO, THE IMPLIED WARRANTIES OF MERCHANTABILITY AND FITNESS FOR A PARTICULAR PURPOSE ARE DISCLAIMED. IN NO EVENT SHALL THE FOUNDATION OR CONTRIBUTORS BE LIABLE FOR ANY DIRECT, INDIRECT, INCIDENTAL, SPECIAL, EXEMPLARY, OR CONSEQUENTIAL DAMAGES (INCLUDING, BUT NOT LIMITED TO, PROCUREMENT OF SUBSTITUTE GOODS OR SERVICES; LOSS OF USE, DATA, OR PROFITS; OR BUSINESS INTERRUPTION) HOWEVER CAUSED AND ON ANY THEORY OF LIABILITY, WHETHER IN CONTRACT, STRICT LIABILITY, OR TORT (INCLUDING NEGLIGENCE OR OTHERWISE) ARISING IN ANY WAY OUT OF THE USE OF THIS SOFTWARE, EVEN IF ADVISED OF THE POSSIBILITY OF SUCH DAMAGE.

■ Mersenne Twister

<http://www.math.sci.hiroshima-u.ac.jp/~m-mat/MT/MT2002/CODES/mt19937ar.c>

Copyright (C) 1997 – 2002, Makoto Matsumoto and Takuji Nishimura,
All rights reserved.

Redistribution and use in source and binary forms, with or without modification, are permitted provided that the following conditions are met:

Redistributions of source code must retain the above copyright notice, this list of conditions and the following disclaimer.

Redistributions in binary form must reproduce the above copyright notice, this list of conditions and the following disclaimer in the documentation and/or other materials provided with the distribution.

The names of its contributors may not be used to endorse or promote products derived from this software without specific prior written permission.



THIS SOFTWARE IS PROVIDED BY THE COPYRIGHT HOLDERS AND CONTRIBUTORS "AS IS" AND ANY EXPRESS OR IMPLIED WARRANTIES, INCLUDING, BUT NOT LIMITED TO, THE IMPLIED WARRANTIES OF MERCHANTABILITY AND FITNESS FOR A PARTICULAR PURPOSE ARE DISCLAIMED. IN NO EVENT SHALL THE COPYRIGHT OWNER OR CONTRIBUTORS BE LIABLE FOR ANY DIRECT, INDIRECT, INCIDENTAL, SPECIAL, EXEMPLARY, OR CONSEQUENTIAL DAMAGES (INCLUDING, BUT NOT LIMITED TO, PROCUREMENT OF SUBSTITUTE GOODS OR SERVICES; LOSS OF USE, DATA, OR PROFITS; OR BUSINESS INTERRUPTION) HOWEVER CAUSED AND ON ANY THEORY OF LIABILITY, WHETHER IN CONTRACT, STRICT LIABILITY, OR TORT (INCLUDING NEGLIGENCE OR OTHERWISE) ARISING IN ANY WAY OUT OF THE USE OF THIS SOFTWARE, EVEN IF ADVISED OF THE POSSIBILITY OF SUCH DAMAGE.

■ zlib

<http://www.zlib.net/>

zlib.h -- interface of the "zlib" general purpose compression library version 1.2.3, July 18th, 2005

Copyright (C) 1995 – 2004 Jean-loup Gailly and Mark Adler

This software is provided "as-is", without any express or implied warranty. In no event will the authors be held liable for any damages arising from the use of this software.

Permission is granted to anyone to use this software for any purpose, including commercial applications, and to alter it and redistribute it freely, subject to the following restrictions:

The origin of this software must not be misrepresented; you must not claim that you wrote the original software. If you use this software in a product, an acknowledgment in the product documentation would be appreciated but is not required.

Altered source versions must be plainly marked as such, and must not be misrepresented as being the original software.

This notice may not be removed or altered from any source distribution.

Jean-loup Gailly jloup@gzip.org, Mark Adler madler@alumni.caltech.edu

■ cURL

<http://curl.haxx.se>

COPYRIGHT AND PERMISSION NOTICE

Copyright (c) 1996 – 2011, Daniel Stenberg, <daniel@haxx.se>.

All rights reserved.

Permission to use, copy, modify, and distribute this software for any purpose with or without fee is hereby granted, provided that the above copyright notice and this permission notice appear in all copies.

THE SOFTWARE IS PROVIDED "AS IS", WITHOUT WARRANTY OF ANY KIND, EXPRESS OR IMPLIED, INCLUDING BUT NOT LIMITED TO THE WARRANTIES OF MERCHANTABILITY, FITNESS FOR A PARTICULAR PURPOSE AND NONINFRINGEMENT OF THIRD PARTY RIGHTS. IN NO EVENT SHALL THE AUTHORS OR COPYRIGHT HOLDERS BE LIABLE FOR ANY CLAIM, DAMAGES OR OTHER LIABILITY, WHETHER IN AN ACTION OF CONTRACT, TORT OR OTHERWISE, ARISING FROM, OUT OF OR IN CONNECTION WITH THE SOFTWARE OR THE USE OR OTHER DEALINGS IN THE SOFTWARE.

Except as contained in this notice, the name of a copyright holder shall not be used in advertising or otherwise to promote the sale, use or other dealings in this Software without prior written authorization of the copyright holder.

■ c-ares

<http://c-ares.haxx.se>

Copyright 1998 by the Massachusetts Institute of Technology.

Permission to use, copy, modify, and distribute this software and its documentation for any purpose and without fee is hereby granted, provided that the above copyright notice appear in all copies and that both that copyright notice and this permission notice appear in supporting documentation, and that the name of M.I.T. not be used in advertising or publicity pertaining to distribution of the software without specific, written prior permission. M.I.T. makes no representations about the suitability of this software for any purpose. It is provided "as is" without express or implied warranty.



■ License information for the software used in the unit

About GPL (GNU-General Public License), LGPL (GNU Lesser General Public License) License

This product uses GPL/LGPL software and software made by other companies.

After you purchase this product, you may procure, modify or distribute the source code of the GPL/LGPL software that is used in the product. Marantz provides the source code based on the GPL and LPGL licenses at the actual cost upon your request to our customer service center.

However, note that we make no guarantees concerning the source code.

Please also understand that we do not offer support for the contents of the source code.





www.marantz.com

You can find your nearest authorized distributor or dealer on our website.

marantz[®] is a registered trademark.

3520 10404 00AM

Copyright ©2015 D&M Holdings Inc. All Rights Reserved.